



EMSEAL PRODUCT CATALOG

Watertight / Fire Rated / Sound Dampening
Transitions / Energy Efficient / Seismic / Trafficable



EXPANSION JOINTS AND SEALANTS
STRUCTURAL AND ARCHITECTURAL

BUILDING TRUST



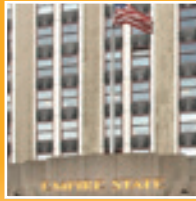

Keep Updated



NOW! Optimized for phones and tablets.

@ www.emseal.com

**Product Data Sheets / Installation Guides / CAD - BIM Details
Product Summaries / Application & Installation Videos
Industry Links / Product Updates / SDS Information
Technology Reports / Manufacturing Lead Times
Project Profiles / International Support / Reps & Distributors
Online Conferencing and Live Tech Support
EMSEAL News and Contacts / ... and more.**

**Get all the latest Sika Emseal information.
Updated DAILY.**



A SIKA COMPANY



BUILDING TRUST





A SIKA COMPANY



Structural & Architectural Expansion Joint & Preformed Sealant Products

The Sika Emseal® Solution

Sika Emseal contributes to the preservation, durability and sustainability of the built environment.

We do so by delivering high value, lowest total cost of ownership, structural expansion joints and precompressed sealants that work.

Innovation has driven breakthrough new materials that ensure continuity-of-seal against water, fire, heat, cold, air movement, and sound in single product, single installation solutions.

We are a team of highly trained, motivated, and personable customer and technical service professionals.

We deliver ready-to-go as well as custom solutions to structural expansion joint and other sealing applications.

Our products are the result of market-driven innovation and decades of experience born of total dedication to the field of expansion joint sealing and component gasketing.

Emseal's track record of successfully completed projects is equally attributable to its approach to expansion joint treatment. Anybody can make an expansion joint appear watertight in cross-section. However, joints leak at changes in plane, direction and where dissimilar joint materials meet.

Successful projects with expansion joints that don't leak are characterized by a collaborative commitment by the A/E team, the general contractor, the joint manufacturer, and the waterproofing sub-contractor to detail, construct, fabricate, and install three-dimensional solutions. Emseal uniquely facilitates this process through a needs analysis and communication process that anticipates and addresses problems before they literally become cast in concrete. This collaborative approach has resulted in the successful execution of watertight expansion joints on new and retrofit projects on structures of every type. Owners, architects, engineers, general contractors, Emseal, and like-minded waterproofing sub-contractors are proving this approach possible and practical.

Applications

Emseal products are designed and manufactured to meet the demands of both the remediation of existing buildings and the maintenance of new structures.

Emseal products address the application demands of modern construction. From small details such as traffic point loads to larger concerns such as LEED certification and seismic design, Emseal is meeting the evolving demands of modern architecture and engineering. This catalog displays Emseal's architectural product line of joint sealant technologies.

Transitions – Sealing the Entire Structure

It is now possible for designers to wrap the entire building envelope, as well as ensure that life-safety is addressed, by specifying expansion joint systems from Emseal that tie into one another for continuity of seal between like or dissimilar technologies.

From below grade under the foundation slab, to blind-side or freestanding foundation walls, to parking decks or plaza decks, to exterior walls and fire-rated interior floors and walls, and up to the roof we have and create custom transitions to seal and fire-rate your building expansion joints throughout.

Sika Emseal Product Features

Breakthroughs in Foam Impregnations

The backpressure resulting from impregnated foam technology eliminates the need for mechanical anchoring methods. Screws and other hardware, which traditionally have been the only means to anchor to a substrate, are eliminated. Non-invasive anchoring allows for a secure hold with simpler installation in a much shorter time.

Emseal's microsphere-modified, 100% acrylic impregnation is unique in enhancing the desirable characteristics of the foam base such as resilience, while imparting water and temperature resistance. This formulation outperforms imitation products and avoids shortcomings such as low temperature brittleness and high temperature instability.

Copyright © 2023 by Sika Corporation. All rights reserved. This catalog or any portion thereof may not be reproduced or used in any manner whatsoever without the express written permission of Emseal.

EMSEAL®, Emshield®, Colorseal®, SecuritySeal®, BackerSeal®, Thermaflex®, and QuietJoint® are registered trademarks of Emseal Joint Systems, Ltd. and Sika Corporation. All other trade names within this publication are the property of their respective owners.

Material is subject to a standard 1-year limited warranty against material defect and workmanship therein which is in lieu of all other written or oral express or implied warranties including any warranties of merchantability or fitness for purpose. Emseal shall not be liable for and expressly disclaims any liability for any damage including incidental, consequential or other damages whether in contract or in tort, including negligence and strict liability. Project specific warranties are available upon request. Contact Sika Emseal.



A SIKA COMPANY

EMSEAL JOINT SYSTEMS, LTD 25 Bridle Lane, Westborough, MA 01581 USA
EMSEAL, LLC 111 Royal Group Crescent, Woodbridge, ON L4H 1X9 Canada

PH: 508-836-0280 FX: 508-836-0281
PH: 416-740-2090 FX: 416-740-0233

First in Fire-Rated, Watertight, Multi-Purpose Joint Seals

Certified by Underwriters Laboratories to the rigors of UL-2079, Emseal's Emshield® series of products is changing the expansion joint sealing game. It is no longer necessary to have to choose between watertightness and fire rating. Because the fire rating is now built into the expansion joint it is no longer necessary to specify two installations of separate joint sealant and fire-resistant joint fillers in either decks or walls. Emseal also offers a pick-resistant, fire-rated expansion joint when vandalism and tampering are an important concern.

Enhanced R-Value

EMSEAL's foam-based, wall-joint systems are excellent insulators. They contain no metal and attach to substrates without invasive metal anchors avoiding any conductive thermal bridge in wall components. Whether for small joints in façade panels or at window perimeters, or in the backup walls of cavity-wall construction, or even in structural walls of block or precast, Emseal joint sealants provide continuity of insulation at all penetrations.

Sound Barrier

Walls sealed with our preformed sealants have sound absorption properties that approximate those of a solid wall. Independent laboratory STC and OITC tests prove that filling a structural joint with an Emseal product can restore the original sound transmission coefficient of the wall itself. Choose a fire-rated Emseal product and the wall is sound-proofed, fire-rated, insulated, color-coordinated and able to move – all in a single product installation.

Commitment to Service and Quality Assurance

At EMSEAL service begins from the first contact and continues throughout the design, procurement and installation process. A comprehensive Emseal representation network throughout the US, Canada, and increasingly throughout the world is serviced locally by Regional Managers and/or representatives and is backed up at our corporate headquarters by dedicated Regional Inside Technical Support staff.

Using project-specific application checklists and web and phone-based collaboration to address job requirements, the support staff will work with you to understand and meet your needs. The result is a working relationship with Emseal that produces the best product choice and solution for your specific project.

Ecologically Sound (LEED)

Emseal's hybrid impregnated materials use water-based emulsions and contain no chlorinated wax, isobutylene or other deleterious chemicals. The unique features of these products are synchronous with LEED design principles and can contribute toward achieving LEED points. And Emseal foam products have an industry-leading lifecycle advantage. Recent LEED projects include sealing all 6,514 windows on the Empire State Building LEED Gold Retrofit.

Corporate Sustainability

Emseal is certified and recognized by SBLP as a leader in sustainable business. The corporate mission of Emseal embraces the commitment to ecological sustainability.



Sika Emseal's Track Record

The list of successful Sika Emseal expansion joint installations is growing every day. We are the basis of design in original construction and are the industry leader for retrofitting existing structures. A small sample of recent work includes:

*Mercedes-Benz Stadium / Empire State Building / Fenway Park
Microsoft Campus / Yankee Stadium / Pentagon
Museum of Modern Art (NY) / Honolulu Airport ConRAC
Mall of America / University of Michigan / Basra Stadium
Louis Armstrong Airport / Seattle Tunnel / Gateway Arch
CN Tower / Texas A&M / Citi Field / Childrens Hospital (PA)
Hudson Yards / CNN Plaza / Manchester Airport / Dell HQ
Petco Park / Walmart Distribution Centers / Lambeau Field
Cal Poly Pomona / Bogota El Dorado International Airport
Bole International Airport / Smithsonian Museum / Target Field
Metro de Panama / Art Institute of Chicago / Clorox Plaza
Foxwoods Casino / US Air Force Academy / Metro Qatar
Abu Dhabi Financial Center / Planet Godrej - India
United States Mint / SoFi Stadium / The World Bank
Berlin Federal Prison / Bryant Denny Stadium (U. of Alabama)
Port Allen River Lock / Atlanta International Airport ConRAC
Allegiant Stadium / TWA Hotel / Lincoln Center
and hundreds of other stadiums, museums, corporate buildings,
residences, schools, airports, hospitals, municipal buildings,
parking garages, bridges and other structures worldwide.*

Our Commitment is Unparalleled

Beyond offering the industry's most innovative and successful line of expansion joints, **we are committed to partnering with you at every phase of the construction process.** From the person answering the phone to the regionally dedicated inside and in-field technical support of our Tech Team and Regional Sales Managers, to our online chat and **videoconferencing** collaboration, Sika Emseal is **completely dedicated** to your satisfaction and the success of your project.

Emseal offers SWRI and AIA certified training in all facets of expansion joint application and installation. Accredited courses are offered locally and at Sika Emseal's corporate headquarters in Westborough, MA.

Comprehensive information is available on the web at **www.emseal.com**. If you would like to discuss a specific application's demands please call us at **508-836-0280**.



A SIKA COMPANY



Wall Joints Above-Grade – Product Selection Guide

Application	Standard Joint Size (at Mean T°)	EMSEAL Product	Cat. Page
Secondary Seal to Field Applied Liquid Sealant, 50% Movement	1/8" to 6" (3 - 150mm)	Backerseal	13
Sealant Joints in Exterior Walls Lowest Cost, Primary Seal, Reel Package Quick Installation, 80% Movement	1/2" to 1 1/4" (12 - 30mm)	Colorseal-On-A-Reel	9
Sealant Joints in Exterior Walls Grindless Quick Installation / Paintable	3/8" to 1 1/2" (10 - 40mm)	SafeReseal	9
Structural Joints in Exterior and Interior Walls 1, 2 or 3-Hour Fire-Rated, Watertight WFR1, WFR2 100% / WFR3 50% Movement	1/2" to 6" (12 - 150mm)	Emshield WFR1 / WFR2 / WFR3	14
Structural Joints in Exterior and Interior Walls Pick-Resistant/Tamper-Resistant 2-Hour Fire-Rated, Watertight SSW2 100%	1/2" to 6" (12 - 150mm)	Emshield SecuritySeal SSW	15
Structural Joints in Exterior Walls Primary Seal, 100% Movement	1/2" to 10" (12 - 250mm)	Colorseal/Seismic Colorseal	10
Curved Expansion Joints New to Old Additions	1/2" to 10" (12 - 250mm)	Colorseal/Seismic Colorseal	10
Dual Sealing One Install 100% Movement	1/2" to 10" (12 - 250mm)	Seismic Colorseal DS	12
Color Switching to Match Substrate Changes	1/2" to 10" (12 - 250mm)	Colorseal/Seismic Colorseal	10
Size Switching to Accommodate Joint Gap Variations	1/8" to 6" (3 - 150mm)	Backerseal Colorseal/Seismic Colorseal	13 10

Usage Guide

Typical Substrates

- Brick
- Stone
- EIFS
- Concrete Blocks
- Gypsum Board
- Pre-cast Panels
- Metal Panelized Systems
- Curtain Walls
- Fire-Rated Walls
- Tamper-Resistant Walls
- Window Walls
- Parapet Walls
- Cavity Walls
- Interior Acoustic
- Sky Bridges
- Window Perimeters

Wall Joints Below-Grade – Product Selection Guide

Application	Standard Joint Size (at Mean T°)	EMSEAL Product	Cat. Page
Back-filled Accessible	2" to 7" (50 - 175mm)	BG System	33
Blind Installed Side	2" to 7" (50 - 175mm)	BG SYSTEM	33

Usage Guide

Typical Substrates

- Foundation Walls
- Tunnel Walls & Floors
- Planter Walls & Floors

The product range is continually being updated. Sika Emseal® reserves the right to modify the specifications of any product.



A SIKA COMPANY

EMSEAL JOINT SYSTEMS, LTD 25 Bridle Lane, Westborough, MA 01581 USA
EMSEAL, LLC 111 Royal Group Crescent, Woodbridge, ON L4H 1X9 Canada

PH: 508-836-0280
PH: 416-740-2090

FX: 508-836-0281
FX: 416-740-0233

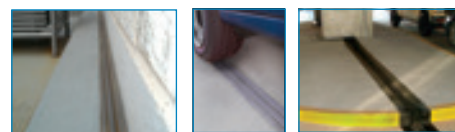

Decks Solid Slab / Precast – Product Selection Guide

Application	Standard Joint Size (at Mean T°)	EMSEAL Product	Cat. Page
Protected or Non-Traffic Deck Applications 100% Movement	1/2" to 8" (12 - 200mm)	Horizontal Colorseal	20
Top and Intermediate Decks 100% Movement	1/2" to 4" (12 - 100mm)	DSM System	16
Tee-to-Tee and Other Control Joints Ideal for Correcting Pour Problems.	1/2" to 4" (12 - 100mm)	DSM System	16
Perimeter Joints	1/2" to 4" (12 - 100mm)	DSM System	16
	1/2" to 8" (12 - 200mm)	Horizontal Colorseal	20
2-Hour Fire-Rated, Top & Intermediate Decks, Watertight, Trafficable, Single Installation DFR2 100% Movement	1/2" to 4" (12 - 100mm)	Emshield DFR2	18
3-Hour Fire-Rated, Top & Intermediate Decks, Watertight, Trafficable, Single Installation DFR3 50% Movement	1/2" to 4" (12 - 100mm)	Emshield DFR3	18
2-Hour Fire-Rated, Pick and Tamper Resistant, Watertight, Trafficable, Single Installation SSF2 100% Movement	1/2" to 4" (12 - 100mm)	Emshield SecuritySeal SSF2	19
3-Hour Fire-Rated, Pick and Tamper Resistant, Watertight, Trafficable, Single Installation SSF3 50% Movement	1/2" to 4" (12 - 100mm)	Emshield SecuritySeal SSF3	19
Top and Intermediate Decks, Blockout Mounted	1" to 5-1/2" max (25 - 140mm)	Thermafex Series	25
Large or Seismic Top and Intermediate Decks Joint-Face Adhered with Integral Coverplate SJS 100% Movement	2" to 16" (50 - 400mm)	SJS System	22
1-Hour Fire-Rated, Large or Seismic Top and Intermediate Decks Joint-Face Adhered with Integral Coverplate, 100% Movement	2" to 10" (50 - 250mm)	SJS-FR1 System	24
2-Hour Fire-Rated, Large or Seismic Top and Intermediate Decks Joint-Face Adhered with Integral Coverplate, 100% Movement	2" to 10" (50 - 250mm)	SJS-FR2 System	24
Elastomeric Concrete Header/Nosing		Emcrete	32

Usage Guide

Typical Substrates

Parking Decks
Roof Joints
Ice Rink Perimeters
Stair/Elevator Tower Perimeters
Stadium Tread and Risers
Sidewalks
Fire-Rated Applications
Airport Aprons
Roadways
Parking Decks
Stadium/Arena Treads & Risers
Concourses
Floors

The product range is continually being updated. Sika Emseal® reserves the right to modify the specifications of any product.



A SIKA COMPANY



Decks Split Slab / Plaza – Product Selection Guide

Application	Standard Joint Size (at Mean T°)	EMSEAL Product	Cat. Page
Integrally Tied into Split Slab Construction	Up to 4 3/4" max (120mm)	Migutan FP	26
Integrally Tied into Split Slab Construction	2" to 8" (50 - 200mm)	RoofJoint	35
For Expansion Joints that Tie into Split Slab Construction, also Solid Slab to Split Slab Construction	1/2" to 4" (12 - 100mm)	DSM-FP System	28
For Expansion Joints that Tie into Split Slab Construction, also Solid Slab to Split Slab Construction, 2-Hour or 3-Hour Fire-Rated	1/2" to 4" (12 - 100mm)	DFR-FP System	29
For Large or Seismic Designed Joints that Tie into Split Slab Construction with Integral Coverplate	2" to 16" (50 - 400mm)	SJS-FP System	30
For Large or Seismic Designed Joints that Tie into Split Slab Construction 1-Hour or 2-Hour Fire-Rated	2" to 10" (50 - 250mm)	SJS-FP-FR System	31

Usage Guide

Typical Substrates

Podium Decks
 Split Slab Plaza Decks
 Garden Roofs
 Green / Blue Roofs
 Roadways
 Stadium Concourses

Roof / Submerged / NSF – Product Selection Guide

Application	Standard Joint Size (at Mean T°)	EMSEAL Product	Cat. Page
Roofs as part of an integrated waterproofing system. Transitions from roof to wall.	2" to 8" (50 - 200mm)	RoofJoint Roof Joint Wall Closure	34 35
Chlorine and Chemical Resistant Continuous Submersion Joint-Face Adhered 50% Movement	1/2" to 4"* (12 - 100mm)	Submerseal	36
Chemical Resistant Joint Face-Adhered 50% Movement	1/2" to 4"* (12 - 100mm)	Submerseal/Chemseal**	36
Non-Contaminating Joint-Face Adhered NSF/ANSI-Certified 50% Movement	1/2" to 8"* (12 - 200mm)	Submerseal/DSF**	36

Usage Guide

Typical Uses

Roofs
 Roof to Wall Transitions
 Water Treatment Facilities
 Water Parks
 Swimming Pools
 Fountains
 Spill Containment
 Chemical Environments
 Potable Water

* For head-pressure limitations please consult with Sika Emseal about your specific needs.
 ** Consult EMSEAL for Submerseal / Chemseal / DSF performance specifications.

The product range is continually being updated. Sika Emseal® reserves the right to modify the specifications of any product.



A SIKA COMPANY

EMSEAL JOINT SYSTEMS, LTD 25 Bridle Lane, Westborough, MA 01581 USA
 EMSEAL, LLC 111 Royal Group Crescent, Woodbridge, ON L4H 1X9 Canada

PH: 508-836-0280
 PH: 416-740-2090

FX: 508-836-0281
 FX: 416-740-0233

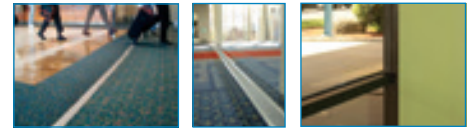

Interior Floors & Walls – Product Selection Guide				Usage Guide
Application	Standard Joint Size (at Mean T°)	EMSEAL Product	Cat. Page	Typical Uses
Interior Floors and Interior Walls	Up to 24" max (600mm) max	Various Products	38-41	Convention Centers Stadiums Arenas Hospitals Warehouses Schools Office Buildings Condos Airports Shopping Malls Casinos Fire-Rated Locations Prisons & Secure Facilities
Interior Walls 1, 2, or 3-Hour Fire-Rated Single Product	1/2" to 6" (12 - 150mm)	Emshield WFR1 / WFR2 / WFR3	14	
Interior Walls Pick-Resistant/Tamper-Resistant 2-Hour Fire-Rated Single Product	1/2" to 6" (12 - 150mm)	Emshield SecuritySeal SSW2	15	
Interior Floors 2-Hour Fire-Rated Single Product	1/2" to 4" (2 - 100mm)	Emshield DFR2	18	
Interior Floors 3-Hour Fire-Rated Single Product	1/2" to 4" (2 - 100mm)	Emshield DFR3	18	
Interior Floors Pick-Resistant/Tamper-Resistant 2-Hour Fire-Rated Single Product	1/2" to 4" (2 - 100mm)	Emshield SecuritySeal SSF2	19	
Interior Floors Pick-Resistant/Tamper-Resistant 3-Hour Fire-Rated Single Product	1/2" to 4" (2 - 100mm)	Emshield SecuritySeal SSF3	19	
Interior Floors Large or Seismic Trafficable Integral Coverplate	2" to 16" (50 - 400mm)	SJS System	22	
Interior Floors Large or Seismic Trafficable Integral Coverplate 1-hour or 2-hour Fire-rated	2" to 10" (50 - 250mm)	SJS-FR System	24	
Interior Walls and Ceilings Acoustic and Thermal Joint and Gap Filler for Non-Moving Joints and Gaps	1" to 6" (25 - 150mm)	QuietJoint	37	

The product range is continually being updated. Sika Emseal® reserves the right to modify the specifications of any product.



A SIKA COMPANY

EMSEAL JOINT SYSTEMS, LTD 25 Bridle Lane, Westborough, MA 01581 USA
EMSEAL, LLC 111 Royal Group Crescent, Woodbridge, ON L4H 1X9 Canada

PH: 508-836-0280
PH: 416-740-2090

FX: 508-836-0281
FX: 416-740-0233

SafeReseal: International Patent Pending



Colorseal-on-a-Reel and **SafeReseal** are watertight sealant-coated, precompressed, primary seals for smaller joints. They are shipped on a reel for rapid installation into 1/2 to 1 1/4-inches wide (12 - 30mm) expansion gaps. Reel-packaging, in contrast to 'stick' packaging: reduces waste, lowers production costs, makes handling easier, and can be put in rapidly. Their low installed cost makes each a price-effective alternate to 'caulk and backer rod'.

Colorseal-on-a-Reel is silicone-coated on the outer weather face and obtainable in many industry-standard colors. It is available in larger width sticks as Seismic Colorseal (see page 10).

SafeReseal is a watertight primary seal as a **grindless installation** alternative joint sealing system for EIFS, precast concrete, CMU and virtually any substrate. SafeReseal is safer, dustless, primerless, tensionless and installs over old sealant residue without the requirement for grinding to completely remove old sealant. It is coated with a hybrid STPE sealant (SikaHyflex®-150 LM) which allows for painting after installation. SafeReseal provides the best solution for retrofit construction and repairs.

- Rapid installation – new or retrofit
- Watertight
- Airtight
- Thermally insulating
- Sound dampening
- Cost-effective
- Ships on 10-foot reels
- Conforms to joint gap irregularities
- ABAA Compliant



Colorseal-on-a-Reel offers a quick and simple installation making it highly suited for tilt-up walls, precast concrete, masonry, sidewalks, driveways and other smaller gap applications.



SafeReseal offers a safe, quick, grindless solution for replacing failed sealants in retrofit construction and repairs. Pictured above, in an EIFS installation, the failed sealant is quickly removed and any remaining remnants are encapsulated in a mounting band of hybrid sealant (SikaHyflex®-150 LM). The final surface is paintable to match the exterior facade walls.

Typical SafeReseal and Colorseal-on-a-Reel Usage

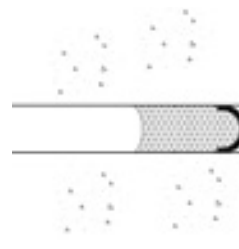

Colorseal-on-a-Reel and SafeReseal are held in place by a combination of pressure-sensitive adhesive impregnation and back-pressure of the expanding foam in conjunction with a field-installed band of sealant caulk.

COR / SAR Sizing

Joint Size at Mean T°F	Depth of Seal
Inches (mm)	Inches (mm)
1/2* (12)	1 3/4 (45)
3/4 (20)	1 3/4 (45)
1 (25)	1 3/4 (45)
1 1/4 ** (30)	1 3/4 (45)

NOTE: SafeReseal can accommodate gap sizes of *3/8" (10mm) and **1 1/2" (40mm)

Standard CAD/BIM details are available online at www.emseal.com. For application specific CAD details contact Sika Emseal directly.

EMSEAL JOINT SYSTEMS, LTD 25 Bridle Lane, Westborough, MA 01581 USA
EMSEAL, LLC 111 Royal Group Crescent, Woodbridge, ON L4H 1X9 Canada

PH: 508-836-0280
 PH: 416-740-2090

FX: 508-836-0281
 FX: 416-740-0233



A SIKA COMPANY



Seismic Colorseal (Colorseal*) is a silicone-coated, precompressed, primary seal that is used in structural, high-movement joints in virtually any substrate. It is ideally suited for watertightness in vertical or horizontal structural, seismic and abutment joints in the vertical plane.

- Watertight
- Non-invasive anchoring
- Primary seal
- Wide range of standard and custom colors
- Conforms to joint gap irregularities
- Size switching accommodates joint gap variations
- Supplied on 10-foot reel for sizes under 1 1/2" (40mm)
Supplied as 6.56" (2M) sticks for sizes larger sizes.
- Thermally insulating
- Acoustic dampening –
STC rated 52 (in a STC 56 wall)
OITC rated 38 (in a OITC 38 wall)
- Bellows remain tension-free during joint movement
- Won't suffer from compression set
- Movement of +/- 50% (Total 100%) of nominal size

**Product Update: Decades of successful performance have proved "Seismic Colorseal" to provide functionally equivalent performance to "Colorseal" while offering more movement capability and better price value. Both products are now built the same, feature the same movement capability and are priced the same. All shipments are marked "Seismic Colorseal".*

Sound Attenuation STC 52 / OITC 38



Seismic Colorseal installed in a building facade between dissimilar materials maintains the R-Value in the building envelope. Because Seismic Colorseal uses no fasteners it is especially suited to filling joints at inside corners.



Notching and bending the foam backing permits the silicone facing of the bellows to remain seamless at directional changes which are historically difficult to make watertight. For CAD details between dissimilar EMSEAL joint technologies please call EMSEAL or go to www.emseal.com.

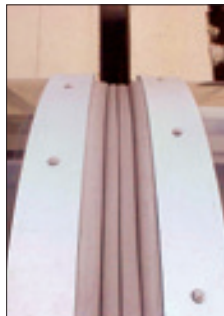

Non-invasive anchoring and sealing is achieved through a combination of the pressure-sensitive adhesive acrylic impregnation, the inherent back pressure of the foam and a field-applied corner bead of silicone.

Curves in building elements are easily accommodated through the material's omni-directional flexibility.



Seismic Colorseal is an ideal solution for textured or rough substrates. The product's pliant nature combined with its inherent backpressure allows it to conform to the textured wall surface.

Standard CAD/BIM details are available online at www.emseal.com. For application specific CAD details contact Sika Emseal directly.

EMSEAL JOINT SYSTEMS, LTD 25 Bridle Lane, Westborough, MA 01581 USA
EMSEAL, LLC 111 Royal Group Crescent, Woodbridge, ON L4H 1X9 Canada

PH: 508-836-0280
PH: 416-740-2090

FX: 508-836-0281
FX: 416-740-0233



A SIKA COMPANY

Seismic Colorseal Sizing

Joint Size at Mean T°F	Depth of Seal
Inches (mm)	Inches (mm)
1/2 * (12)	1 3/4 (45)
3/4* (20)	1 3/4 (45)
1* (25)	1 3/4 (45)
1 1/4 * (35)	1 3/4 (45)
1 1/2 (40)	2 1/4 (55)
2 (50)	2 1/2 (65)
3 (75)	3 1/2 (90)
4 (100)	4 1/2 (115)
5 (125)	5 1/2 (140)
6 (150)	6 (150)
7 (175)	7 (175)
8 (200)	8 (200)
9 (225)	8 (200)
10 (250)	8 (200)

Seismic Colorseal sizes are available in 1/4" increments in nominal sizes from 1" to 6", and 1/2" increments from 6" to 10". Consult Sika Emseal for larger sizes. Nominal size is equivalent to joint gap size at mean temperature.

* Supplied on 10-foot Reels

Seismic Colorseal (Colorseal*) silicone bellows are available in many industry standard colors to match leading construction silicone sealants.. Contact EMSEAL for matching availability.



Now Available
**Seismic Colorseal
 UNIVERSAL-90's**
 Factory-Fabricated
 Transitions & Terminations

See page 21

Typical Seismic Colorseal Usage

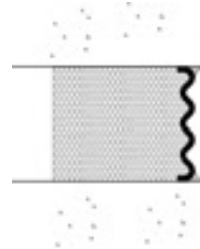

Seismic Colorseal is held in place by the back-pressure of the expanding foam in conjunction with a field-installed bead of silicone caulk at the substrate-to-bellows interface.

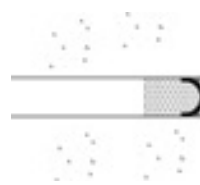

Sizes from 1/2-inch (12mm) to 1 1/4 (30mm) are manufactured with a single bellows silicone face. Larger sizes up to 8-inches (200mm) are manufactured with multiple bellows.

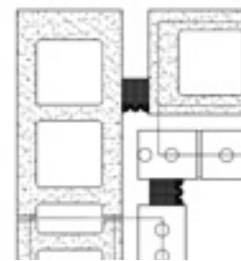

Seismic Colorseal is an excellent, simple sealing solution at inside corner conditions where it is impossible to install mechanically fastened 'strip-seal' systems. In cavity-wall conditions, installation of Seismic Colorseal in the structural backup maintains integrity of thermal insulation as well as the air barrier while preventing passage of cavity moisture into the structure.

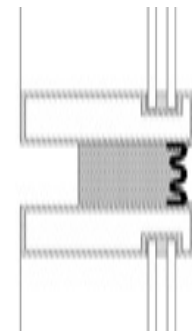

Seismic Colorseal is uniquely suited to sealing structural joints in curtainwalls. Non-invasive anchoring means that mullions are not violated by screwing through them as occurs with "strip-seal" systems.

Standard CAD/BIM details are available online at www.emseal.com. For application specific CAD details contact Sika Emseal directly.

Seismic Colorseal-DS

WALLS Above Grade

Watertight by design®

WALLS – Above Grade

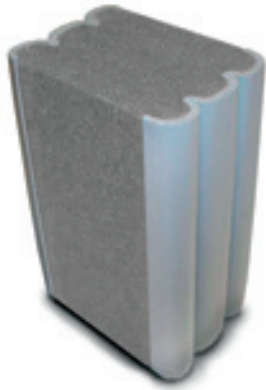

Seismic Colorseal-DS seals interior and exterior sides of curtain wall joints in a single installation step. Each side can have its own color to match interior and exterior color schemes. For parapets it can provide a top, front, and back sealed surface addressing all three exposed planes.

Seismic Colorseal-DS is a unique, highly innovative, double-side coated variation of Sika Emseal's acclaimed Seismic Colorseal material. Ideally suited for shallow substrates where sealing or finishing of both sides of the structure is desired in one installation.

- Watertight
- Rapid installation to seal two surfaces (front and back) in a single installation
- Non-invasive anchoring
- Wide range of standard and custom colors
- Conforms to joint gap irregularities
- Size switching accommodates joint gap variations
- Thermally insulating
- Acoustic dampening –
STC rated 54 (in a STC 56 wall)
OITC rated 38 (in a OITC 38 wall)
- Bellows remain tension-free during joint movement
- Movement of +/- 50% (Total 100%) of nominal size in any direction

Seismic Colorseal-DS Sizing

Joint Size at Mean T°F	Depth of Seal
Inches (mm)	Inches(mm)
1/2 (12)	2 3/4 (70)
3/4 (20)	2 3/4 (70)
1 (25)	2 3/4 (70)
2 (50)	2 1/2 (65)
3 (75)	3 1/2 (90)
4 (100)	4 1/2 (115)
5 (125)	5 1/2 (140)
6 (150)	6 (150)
7 (175)	7 (175)
8 (200)	8 (200)
9 (225)	8 (200)
10 (250)	8 (200)

Seismic Colorseal-DS sizes are available in 1/4" increments in nominal sizes from 1" to 6", and 1/2" increments from 6" to 10". Consult Sika Emseal for larger sizes. Nominal size is equivalent to joint gap size at mean temperature.



Now Available
**Seismic Colorseal-DS
UNIVERSAL-90's**
Factory-Fabricated
Transitions & Terminations

See page 21

Sound Attenuation STC 54 / OITC 38

Typical Seismic Colorseal-DS Usage

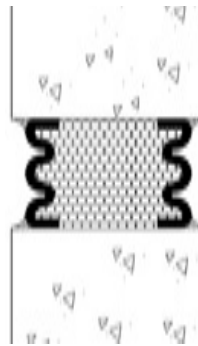

Seismic Colorseal-DS can be made in custom depths to seal both sides of shallow substrates.

Seismic Colorseal-DS is ideal for sealing both the exterior and interior faces of window and curtainwall systems. Colors on each face can be chosen to coordinate with interior and exterior finishes. Non-invasive anchoring preserves the integrity of the substrates while the product's inherent R-value ensures continuity of insulation.

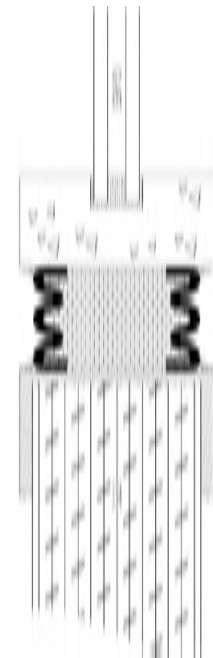

A SIKA COMPANY

EMSEAL JOINT SYSTEMS, LTD 25 Bridle Lane, Westborough, MA 01581 USA
EMSEAL, LLC 111 Royal Group Crescent, Woodbridge, ON L4H 1X9 Canada

PH: 508-836-0280
PH: 416-740-2090

FX: 508-836-0281
FX: 416-740-0233



Structures of all sizes can benefit from the sealing of thermal and sound conditions as well as the ease-of-installation offered by Backerseal



Backerseal behind field-applied liquid sealant provides true "belts and suspenders" sealing – 2 systems working on different principles to guarantee performance of the same function.

Backerseal (Greyflex) is an economical preformed expanding foam sealant that provides watertight secondary sealing in applications behind conventionally installed liquid sealant and backer rod or directly behind field-applied low modulus liquid sealants.

- Watertight
- Featuring Sika Emseal's exclusive, breakthrough, hydrophobic acrylic impregnation technology
- Watertight, odorless, clean handling, non-staining, low-temperature flexible, high-temperature stable
- Thermally insulating
- Acoustic dampening –
STC rated 53 (in a STC 68 wall)
OITC rated 49 (in a OITC 52 wall)
- Conforms to joint gap irregularities
- Also available in sticks
- Movement of +/- 25% (Total 50%) of nominal size

◆ Sound Attenuation ◆ STC 53 / OITC 49

Typical Backerseal Usage

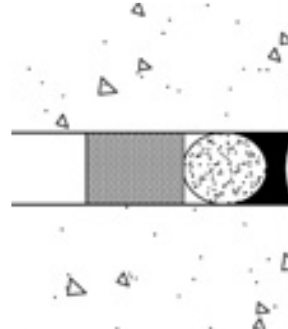

Backerseal in place as a secondary seal to liquid sealant and backer rod. This double system ensures a redundant seal to water and insulates against energy loss while preserving the liquid sealant manufacturer's geometry for optimal performance.

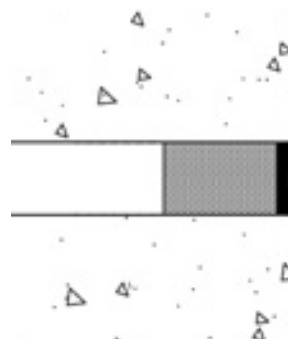

Backerseal with directly-applied, low modulus liquid sealant provides redundant sealing in shallow-depth substrates.

Backerseal Sizing

Joint Size at Mean T°F		Depth of Seal	
Inches	(mm)	Inches	(mm)
1/8	(3)	5/8	(15)
1/4	(6)	3/4	(20)
3/8	(10)	3/4	(20)
1/2	(12)	3/4	(20)
5/8	(15)	1	(25)
3/4	(20)	1	(25)
1	(25)	1 1/4	(30)
2	(50)	2 1/2	(65)
3	(75)	3 1/8	(80)
4	(100)	4	(100)
5	(125)	5	(125)
6	(150)	6	(160)

Backerseal sizes are available in 1/4" increments in nominal sizes from 1" to 6". Nominal size is equivalent to joint gap size at mean temperature.

Standard CAD/BIM details are available online at www.emseal.com. For application specific CAD details contact Sika Emseal directly.



Emshield® WFR1 / WFR2 / WFR3

US Patents 9,670,666 9,637,915 9,068,297 8,739,495 C1 10,934,702 10,934,704 10,941,562

WALLS – Above Grade
UL / ULC FIRE-RATED

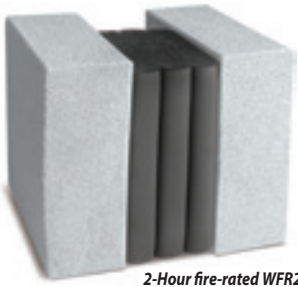

Watertight, Energy-Efficient 1-hour, 2-hour and 3-hour Fire-Rated Wall Expansion Joint

Emshield® WFR1, WFR2 and WFR3 are single-unit, fire-rated expansion joints which provide water protection, sound attenuation, thermal insulation, color coordination, and accommodate structural joint movement. WFR1 (Wall, Fire-Rated 1-Hour), WFR2 (Wall, Fire-Rated 2-Hours) and WFR3* (Wall, Fire-Rated 3-Hours) continue the line of breakthrough, multi-function, structural expansion joint materials from Sika Emseal. Both have been tested and certified by Underwriters Laboratories (UL) to the rigors of UL and ULC 2079.

Fire-retardant impregnated foam is factory pre-coated on both faces with a waterproof silicone coating which is available in a wide choice of colors (*contact Emseal*) for each side. *WFR3 is also pre-coated on both faces with an intumescent fire-proofing material.

Providing an excellent barrier to sound transfer, WFR1, WFR2 and WFR3 have an STC rating of 62 (in a STC 68 wall) and an OITC rating of 52 (in a OITC 52 wall). They have also been tested to ASTM E330, ASTM E331, and ASTM E283 standards maintaining air pressure and stopping water and wind penetration at 200 mph.

Emshield WFR1, WFR2 and WFR3 provide a watertight, clean handling, UV stable, non-staining, low-temperature-flexible, high-temperature-stable, energy-efficient, sound attenuating and fire-rated joint seal in a single installation process. For interior and exterior walls. WFR1 and WFR2 movements of +/- 50% (100% total). WFR3 movements of +/- 25% (50% total).

Emshield WFR1 / WFR2 / WFR3 Sizing

Joint Size at Mean T°F	WFR1 / WFR2 Depth of Seal	WFR3 Depth of Seal
Inches (mm)	Inches (mm)	Inches (mm)
1/2 (12)	4 (100)	5 (125)
3/4 (20)	4 (100)	5 (125)
1 (25)	4 (100)	5 (125)
1 1/4 (30)	4 (100)	5 (125)
1 1/2 (40)	4 (100)	5 (125)
1 3/4 (45)	4 (100)	5 (125)
2 (50)	4 (100)	5 (125)
3 (75)	4 (100)	5 (125)
4 (100)	4 (100)	5 (125)
5 (125)	4 (100)	5 (125)
6 (150)	4 (100)	5 (125)

WFR sizes are available in 1/4" increments of nominal sizes from 1" to 6". Nominal size is equivalent to joint gap size at mean temperature.



Now Available
**Emshield WFR
UNIVERSAL-90's**
Factory-Fabricated
Transitions & Terminations
See page 21



Water / Fire / Energy / Sound / Movement

◆ Sound Attenuation ◆ STC 62 / OITC 52

Emshield WFR1 and WFR2

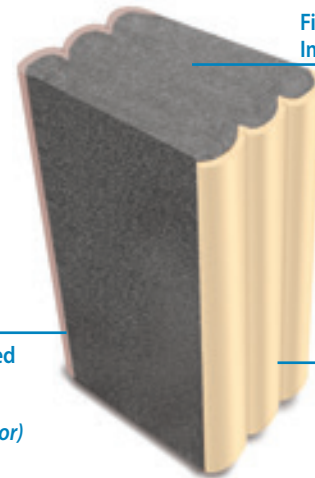

Silicone-Faced Bellows
(Shown in an alternate color)

One Install Does It All



UL Systems
WW-D-0091, WW-D-0092, WW-D-1079
WW-D-1081, HW-D-0615, HW-D-1090
WW-D-1158, WW-D-1159, WW-D-0099
WW-D-1087, WW-D-0239, WW-D-1220

ULC Systems
JF131, JF132, HW77, JF145



Standard CAD/BIM details are available online at www.emseal.com. For application specific CAD details contact Sika Emseal directly.

EMSEAL JOINT SYSTEMS, LTD 25 Bridle Lane, Westborough, MA 01581 USA
EMSEAL, LLC 111 Royal Group Crescent, Woodbridge, ON L4H 1X9 Canada

PH: 508-836-0280 FX: 508-836-0281
PH: 416-740-2090 FX: 416-740-0233

A SIKA COMPANY

SecuritySeal® SSW

US Patents 9,670,666 9,637,915 9,068,297 8,739,495 C1 10,934,702 10,934,704 10,941,562



Pick-Resistant, 2-hour Fire-Rated, Watertight, Wall Expansion Joint

EMSHIELD® SecuritySeal® SSW2 is a pick-resistant, watertight, 2-hour fire-rated, expansion joint for vertical locations requiring a hardened tamper-resistant surface. Institutional walls found in prisons, detention centers, mental and psychiatric hospitals, school facilities, and day-care centers are some of the many venues where SecuritySeal SSW is preferred.

- Watertight
- Hardened pick-resistant surface
- 2-hour built-in fire rating (UL/ULC-certified)
- Non-invasive anchoring
- Size switching accommodates joint gap variations
- Thermally insulating
- Acoustic dampening –
STC rated 62 (in a STC 68 wall)
OITC rated 52 (in a OITC 52 wall)
- Won't suffer from compression set
- Movement of +/- 50% (Total 100%) of nominal size

SecuritySeal SSW2 Sizing

Joint Size at Mean T°F	Depth of Seal
Inches (mm)	Inches (mm)
1/2 (12)	4 (100)
3/4 (20)	4 (100)
1 (25)	4 (100)
1 1/4 (30)	4 (100)
1 1/2 (40)	4 (100)
1 3/4 (45)	4 (100)
2 (50)	4 (100)
3 (75)	4 (100)
4 (100)	4 (100)
5 (125)	4 (100)
6 (150)	4 (100)

SSW2 sizes are available in 1/4" increments of nominal sizes from 1" to 6". Nominal size is equivalent to joint gap size at mean temperature.



Now Available
**SecuritySeal
UNIVERSAL-90's**
Factory-Fabricated
Transitions & Terminations

See page 21

▼ FIRE-RATED

WALLS Above Grade

Watertight by design®



Vandalism / Water / Fire / Movement / Sound

Sound Attenuation STC 62 / OITC 52

Typical SecuritySeal SSW Usage

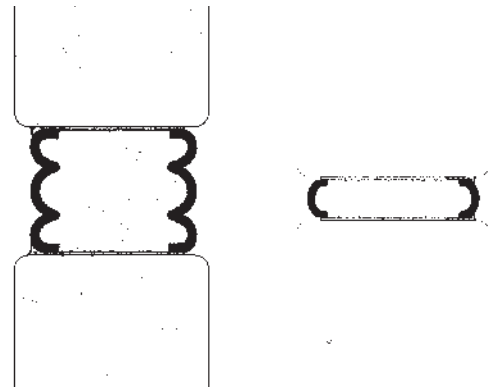

Topview of SecuritySeal SSW. Installed in a fire-rated wall, the front face is sealed with a polyurethane corner bead for watertightness.

SecuritySeal SSW is manufactured with a single bellow polyurethane face on both sides when used in a gap from 1/2-inch (12mm) to 1 1/4-inch (30mm). (Topview)



UL Systems
WW-D-0093, WW-D-1083,
HW-D-0616, HW-D-1091

ULC Systems
JF134, HW78



A SIKA COMPANY

Standard CAD/BIM details are available online at www.emseal.com. For application specific CAD details contact Sika Emseal directly.

EMSEAL JOINT SYSTEMS, LTD 25 Bridle Lane, Westborough, MA 01581 USA
EMSEAL, LLC 111 Royal Group Crescent, Woodbridge, ON L4H 1X9 Canada

PH: 508-836-0280
PH: 416-740-2090

FX: 508-836-0281
FX: 416-740-0233



The **DSM System** is a traffic durable, joint-face adhered, precompressed primary seal. Using a microsphere-modified-acrylic impregnation and factory pre-coated with highway-grade silicone, this system builds on Sika Emseal's track record of over 30 years of sealing horizontal plane joints with impregnated foam sealants.

- Traffic durable
- Watertight
- UV stable
- Non-invasive anchoring
- Non-staining
- ADA compliant
- Rapid installation – new or retrofit
- Low-temperature flexible, high-temperature stable
- Conforms to joint gap irregularities
- Size switching accommodates joint gap variations
- Movement of +50% and -50% (Total 100%) of nominal size *



DSM features easy installation. After epoxy has been applied to the substrate the DSM foam sticks are pushed into the joint. Adjoining sticks are aligned into the face of the already installed stick and held above the surface until the adjoining stick is seated into the joint.



The waterproofing of stadium expansion joints seen here in the precast seating bowl. DSM offers continuity of seal through changes in plane and direction.



DSM is uniquely suited to retrofitting existing joints and readily replaces failed caulk, compression seals, inflated seal, and closed-cell joint fillers.



The DSM System is a traffic-durable, lasting solution to high movement and heavy load traffic found in today's parking structures. New construction and retrofit applications are a perfect fit for DSM.

Standard CAD/BIM details are available online at www.emseal.com. For application specific CAD details contact Sika Emseal directly.

EMSEAL JOINT SYSTEMS, LTD 25 Bridle Lane, Westborough, MA 01581 USA
EMSEAL, LLC 111 Royal Group Crescent, Woodbridge, ON L4H 1X9 Canada

PH: 508-836-0280
PH: 416-740-2090

FX: 508-836-0281
FX: 416-740-0233



A SIKA COMPANY

DSM Sizing

Joint Size at Mean T°F	Depth of Seal
Inches (mm)	Inches (mm)
1/2 (12)	1 3/4 (45)
3/4 (20)	1 3/4 (45)
1 (25)	2 (50)
2 (50)	2 1/2 (65)
3 (75)	3 1/4 (80)
4 (100)	4 (100)

DSM sizes are available in 1/4" increments in nominal sizes from 1" to 4". Consult Sika Emseal for larger sizes. Nominal size is equivalent to joint gap size at mean temperature.



DSM System technology provides a structural joint sealant solution. Here DSM is installed at the top of a ramp where a driveway transitions from on-grade to supported slab and from deck-to-deck to deck-to-wall.

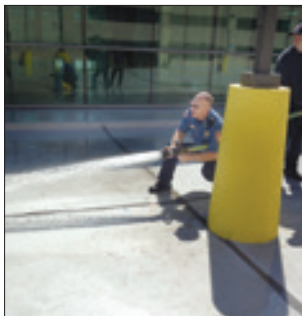

120 gallon per minute fire-hose water test proves DSM System is watertight along its length, at joints and even at cross intersections of multiple sizes. Size switching ensures correct size product is in place despite joint size variation.



Now Available
**DSM System
 UNIVERSAL-90's**
 Factory-Fabricated
 Transitions & Terminations

See page 21

Typical DSM Usage

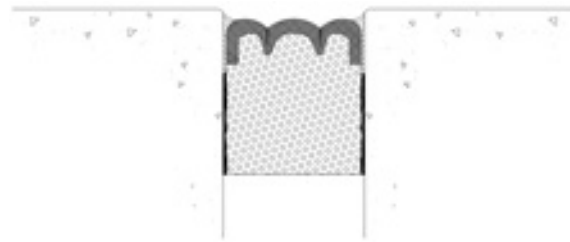

DSM is an ideal solution for deck to deck light and heavy traffic. This watertight product is easily installed and provides a low service cost during its life span.

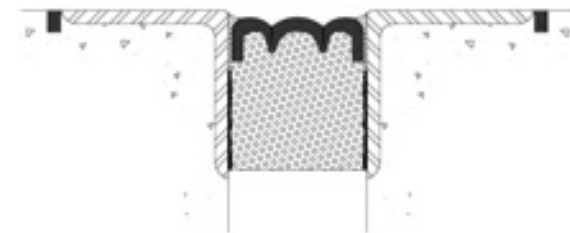

Where metal angles exist and cannot be removed DSM can be installed into the existing metal angles.

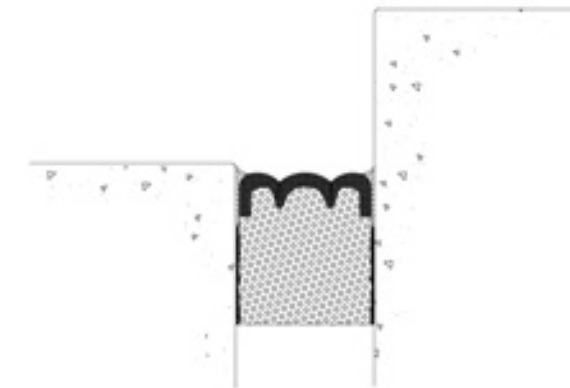

The non-invasive anchoring method makes DSM a great choice for deck-to-wall applications.

Standard CAD/BIM details are available online at www.emseal.com. For application specific CAD details contact Sika Emseal directly.

Emshield® DFR2 / DFR3

▼ FIRE-RATED

DECKS Solid Slab

Watertight by design®

US Patents: 10,934,702 10,934,704 10,941,562 9,670,666 9,637,915 9,068,297 8,739,495 C1

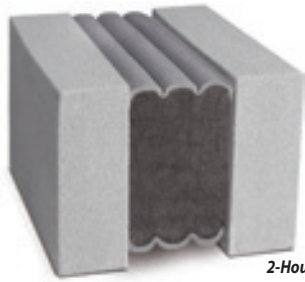

2-Hour fire-rated DFR2

Traffic Durable, Watertight, 2-hour & 3-hour Fire-Rated Deck/Floor Expansion Joint

Emshield® DFR2 and DFR3 are single unit fire-rated, traffic durable, high movement and watertight expansion joints. Emshield DFR2 (Deck, Fire-Rated 2-Hours) and Emshield DFR3 (Deck, Fire-Rated 3-Hours) have been tested and certified by Underwriters Laboratories (UL) to the rigors of UL and ULC 2079.

Installed entirely from floor/deck surface above allowing for easier installation without compromising continuity of the fire-barrier from obstructions (e.g. columns, HVAC, electrical, plumbing, etc.)

Emshield DFR2 and DFR3 provide a watertight, clean handling, UV stable, non-staining, low-temperature-flexible, high-temperature-stable, traffic durable and fire-rated joint seal in a single installation process.

- Watertight
- Built-in fire-rating
- Conforms to joint gap irregularities
- Installed from above floor/deck
No lifts or holding labor needed
- Eliminates traditional need for fire-blankets or gutters
- Acoustic dampening – STC rated 62 / OITC rated 52
- Non-invasive anchoring
- DFR2 Movement of +/- 50% (Total 100%)
DFR3 Movement of +/- 25% (Total 50%)

Emshield DFR2/3 Sizing

Joint Size at Mean T°F	Depth of Seal
Inches (mm)	Inches (mm)
1/2 (12)	4 (100)
1 (25)	4 (100)
2 (50)	4 (100)
3 (75)	4 (100)
4 (100)	4 (100)

DFR2 and DFR3 nominal material size is equivalent to joint gap size at mean temperature. Also available in 1/4 inch increments from 1/2-inch to 4-inches.



Now Available
Emshield DFR
UNIVERSAL-90's
Factory-Fabricated
Transitions & Terminations

See page 21



Sound Attenuation STC 62 / OITC 52

Typical DFR2/DFR3 Usage

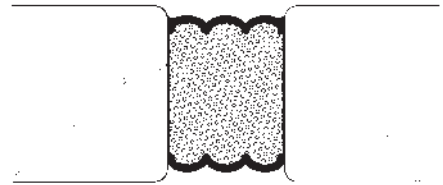

Emshield DFR2 and DFR3 can be installed in interior and exterior horizontal locations needing a UL/ULC certified fire rating. Its non-invasive anchoring design allows it to be easily installed in deck-to-deck (floor-to-floor) or deck-to-wall locations. Parking garages, mechanical rooms, stadiums, retail stores, and other locations with trafficable floor/deck conditions will benefit from the installation of this watertight, sound-suppressing, thermally insulating fire-rated expansion joint. (DFR2 shown above / DFR3 shown below)

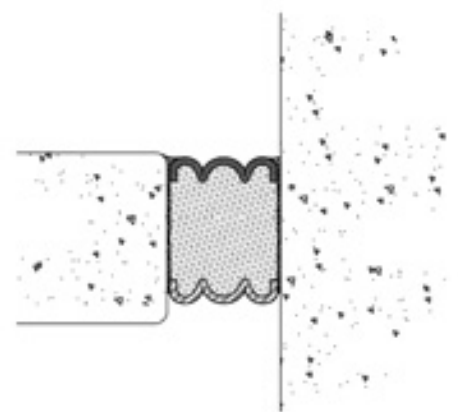

UL Systems
FF-D-0075, FF-D-1086, FW-D-0052
FW-D-1073, FF-D-0078, FF-D-1090
FW-D-0053, FW-D-1075

ULC Systems
JF130, JF133, JF137, JF138



A SIKA COMPANY

Standard CAD/BIM details are available online at www.emseal.com. For application specific CAD details contact Sika Emseal directly.

EMSEAL JOINT SYSTEMS, LTD 25 Bridle Lane, Westborough, MA 01581 USA
EMSEAL, LLC 111 Royal Group Crescent, Woodbridge, ON L4H 1X9 Canada

PH: 508-836-0280
PH: 416-740-2090

FX: 508-836-0281
FX: 416-740-0233

SecuritySeal® SSF2 / SSF3

US Patents 9,670,666 9,637,915 9,068,297 8,739,495 C1 10,934,702 10,934,704 10,941,562

▼ FIRE-RATED

DECKS Solid Slab

Watertight by design®

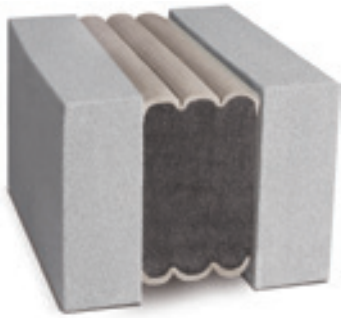

Pick-Resistant, 2-hour and 3-hour Fire-Rated, Watertight, Floor/Deck Expansion Joint

Emshield® SecuritySeal® SSF2 and SecuritySeal® SSF3 are pick-resistant, watertight, 2-hour (SSF2) and 3-hour (SSF3) fire-rated expansion joints for horizontal locations requiring a hardened tamper-resistant surface.

Installed entirely from floor/deck surface above allowing for easier installation without compromising continuity of the fire-barrier from obstructions (e.g. columns, HVAC, electrical, plumbing, etc.)

Floors and decks found in prisons, detention centers, public parking garages, mental and psychiatric hospitals, and school facilities are some of the many venues where SecuritySeal SSF is the perfect choice. Floor joints which join fire-rated walls in common rooms, mechanical rooms, and stairwells are typical locations of use.

- Hardened pick-resistant surface
- 2-hour and 3-hour built-in fire-rated (UL/ULC-certified)
- Watertight
- Non-invasive anchoring
- Installed from above floor/deck
No lifts or holding labor needed
- Acoustic dampening – STC rated 62 / OITC rated 52
- SSF2 Movement of +/- 50% (Total 100%) of nominal size
SSF3 Movement of +/- 25% (Total 50%) of nominal size

SecuritySeal SSF2 / SSF3 Sizing

Joint Size at Mean T°F	Depth of Seal
Inches (mm)	Inches (mm)
1/2 (12)	4 (100)
1 (25)	4 (100)
2 (50)	4 (100)
3 (75)	4 (100)
4 (100)	4 (100)

SSF2 and SSF3 nominal material size is equivalent to joint gap size at mean temperature. Also available in 1/4 inch increments from 1/2-inch to 4-inches.



Now Available
**SecuritySeal
UNIVERSAL-90's**
Factory-Fabricated
Transitions & Terminations

See page 21



Vandalism / Water / Fire / Traffic / Sound

Sound Attenuation STC 62 / OITC 52

Typical SecuritySeal SSF Usage



SecuritySeal SSF2 and SSF3 are manufactured with a single bellow face when used in a gap from 1/2-inch (12mm) to 1 1/2-inch (40mm). (SSF2 shown above)

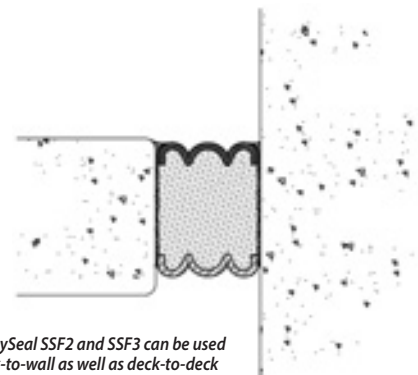

SecuritySeal SSF2 and SSF3 can be used in deck-to-wall as well as deck-to-deck applications. (SSF3 shown above)



UL Systems
FF-D-0077, FF-D-1089, FW-D-0055
FW-D-1077, FF-D-0076, FF-D-1088
FW-D-0054, FW-D-1076

UL Systems
JF135, JF136, JF139, JF141



A SIKA COMPANY

Standard CAD/BIM details are available online at www.emseal.com. For application specific CAD details contact Sika Emseal directly.

EMSEAL JOINT SYSTEMS, LTD 25 Bridle Lane, Westborough, MA 01581 USA
EMSEAL, LLC 111 Royal Group Crescent, Woodbridge, ON L4H 1X9 Canada

PH: 508-836-0280
PH: 416-740-2090

FX: 508-836-0281
FX: 416-740-0233

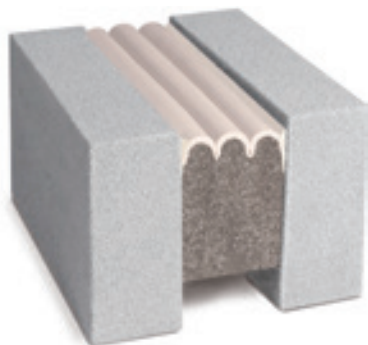

Horizontal Colorseal is selected to blend with the color of the surrounding substrate. It is an ideal solution in non-traffic situations and has the unique ability to handle curved joints large and small.

DECKS – Solid Slab / Precast

Horizontal Colorseal is a high-movement silicone bellows system for deck applications used as a primary seal typically without a coverplate in non-traffic areas such as perimeters in decks or roofs. It can be used under a coverplate when pedestrian or vehicular traffic is expected.

- Watertight
- Non-invasive anchoring
- Supplied on 10-foot reel for sizes under 1 1/2" (40mm)
Supplied as 6.56" (2M) sticks for sizes larger sizes.
- Wide range of standard and custom colors
- Conforms to joint gap irregularities
- Size switching accommodates joint gap variations
- Thermally insulating and acoustic dampening
- Bellows are never under tension during joint movement
- No blockout required
- Movement of +/- 50% (Total 100%) of nominal size

Horizontal Colorseal Sizing

Joint Size at Mean T°F	Depth of Seal
Inches (mm)	Inches (mm)
1/2* (12)	1 3/4 (45)
3/4* (20)	1 3/4 (45)
1* (25)	1 3/4 (45)
1 1/4 * (35)	1 3/4 (45)
2 (50)	2 1/2 (65)
3 (75)	3 1/2 (90)
4 (100)	4 1/2 (115)
5 (125)	5 1/2 (140)
6 (150)	6 (150)
7 (175)	7 (175)
8 (200)	8 (200)

Horizontal Colorseal sizes are available in 1/4" increments in nominal sizes from 1" to 6", and 1/2" increments from 6" to 8". Nominal size is equivalent to joint gap size at mean temperature. * Supplied on 10-foot Reels



Now Available
**Horizontal Colorseal
 UNIVERSAL-90's**
 Factory-Fabricated
 Transitions & Terminations

See page 21

Typical Horizontal Colorseal Usage

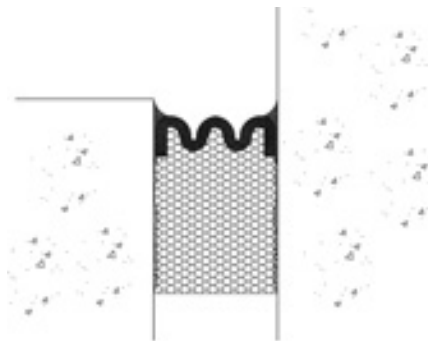

Horizontal Colorseal is often installed at the junction of a deck and wall.

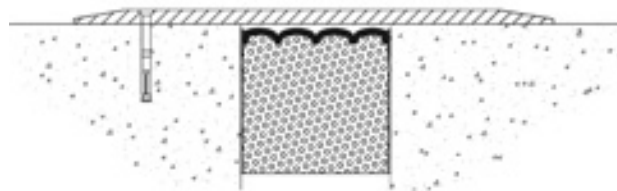

Horizontal Colorseal is typically installed in an area where vehicular or pedestrian traffic does not come in direct contact with the seal. In required vehicular situations it can be installed in conjunction with a metal coverplate, however Sika Emseal recommends the SJS system (see page 22).

Standard CAD/BIM details are available online at www.emseal.com. For application specific CAD details contact Sika Emseal directly.



A SIKA COMPANY



Continuity of Seal at Upturns, Downturns and Termination Points

Universal-90's Transitions and Terminations are patented, factory-fabricated, single-piece 90° units constructed from the same materials as the connecting precompressed expansion joint system. Bellows are constructed on both sides allowing a waterseal in an inner or outer 90° corner. This single unit achieves the greatest possible continuity of seal in transitions in planes, avoiding the limitations of field-made joins.

Using Universal 90's in your expansion joint design ensures continuity of seal. Installation time is reduced and the integrity of the seal is maintained.

Universal-90's are available for all coated Emseal products.

Some of the many applications:

- Stadiums
- Arenas
- Parking decks
- Floors
- Deck-to-wall
- Elevator tower perimeters
- Deck-to-deck
- Bridge expansion joints
- Water tanks
- Stair tower perimeters
- Tunnels and enclosures

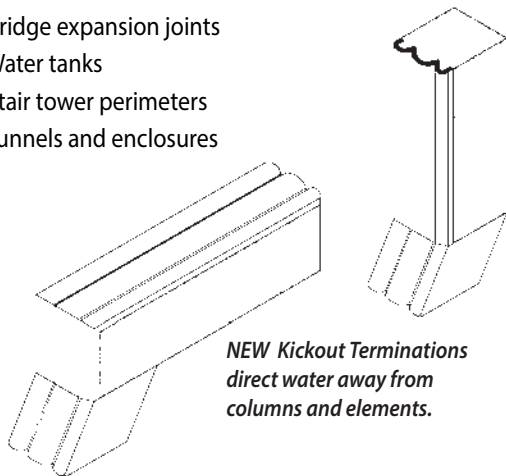

Universal-90 Configurations

Transitions

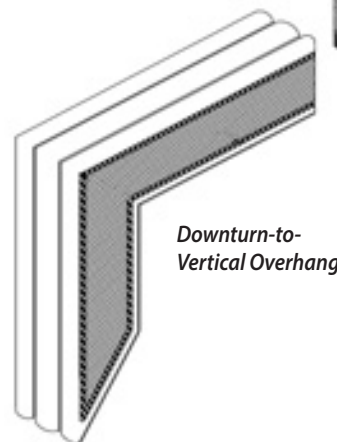
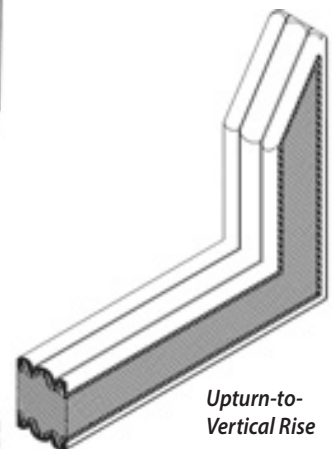
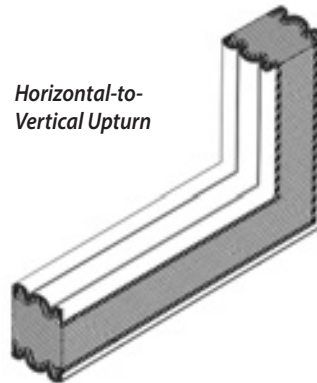
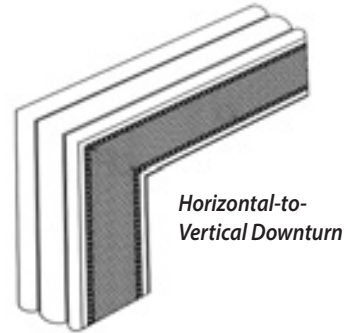

Terminations



A SIKA COMPANY

Standard CAD/BIM details are available online at www.emseal.com. For application specific CAD details contact Sika Emseal directly.

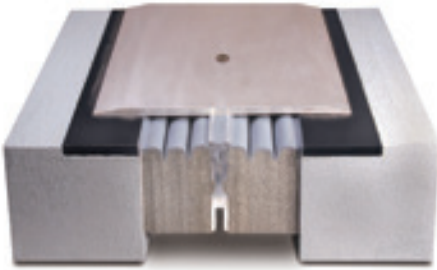

SJS is a watertight, high-movement, sound-dampened coverplate system for large and seismic expansion joint gaps. SJS is constructed from two horizontal joints pre-assembled in parallel adjacent to a heavy-duty extruded aluminum spline. The system contains no metal embeds, self-centering bars, or other unnecessary metal components. The spline acts as a receptor for attaching the surface-mounted traffic plates that bear vehicle and other loads.

- Watertight
- Easy installation with non-invasive anchoring
- No hard metal-to-concrete connections
- Factory fabricated changes in plane and direction
- Aluminum or stainless steel coverplates available
- Field-adjustable plate support
- The quietest coverplate system available when installed with Emseal-supplied elastomeric nosing material
- Coverplate is easy to install with self-locating, vibration-dampening screws
- Does not depend on a gutter
- Designed for gaps of 2-inches (50mm) or larger
- Movement of +/- 50% (Total 100%) of nominal size
- Fire-Rated version also available. *See Page 24*
 *SJS-FR1 1-hour UL/ULC-certified
 *SJS-FR2 2-hour UL/ULC-certified



The back pressure of the SJS foam and an epoxy adhesive provides watertightness with non-invasive anchoring without relying on a gutter. Installation is faster than other more complicated systems.



EMSEAL offers pre-fabricated factory transitions for treads and risers which allow for ease of installation and which also ensure watertightness in changes of plane.



Installation is completed with aluminum or stainless steel coverplates. The center spline functions as a continuous receptor for the self-locating coverplate screws allowing for greater ease of installation. The coverplate edge-chamfer is available in standard or optional low-slope configurations.



Watertightness is assured at the traffic surface negating the need for ineffective moisture barriers and secondary gutters.

Standard CAD/BIM details are available online at www.emseal.com. For application specific CAD details contact Sika Emseal directly.

SJS Sizing

Joint Size at Mean T°F		Depth of Seal	
Inches	(mm)	Inches	(mm)
2	(50)	3	(75)
2 1/2	(65)	3	(75)
3	(75)	3	(75)
3 1/2	(90)	3	(75)
4	(100)	4	(100)
5	(125)	4	(100)
6	(150)	4	(100)
7	(175)	4	(100)
8	(200)	4	(100)
9	(225)	5	(125)
10	(250)	5	(125)
11	(275)	5	(125)
12	(300)	5	(125)
13	(325)	5	(125)
14	(350)	5	(125)
15	(372)	5	(125)
16	(400)	5	(125)

SJS sizes are available in nominal sizes from 2" to 16". Consult Sika Emseal for larger sizes. Nominal size is equivalent to joint gap size at mean temperature.

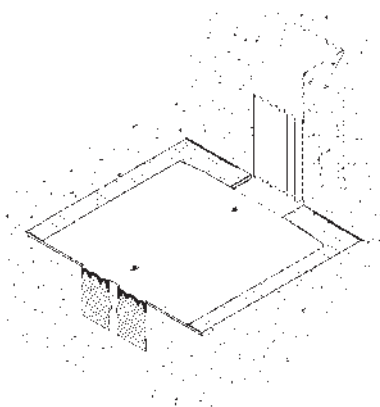

The SJS Seismic Joint System provides an effective large-gap waterproofing solution. It can also transition to other Emseal foam products in the vertical plane as seen in this SJS-to-Seismic Colorseal transition.

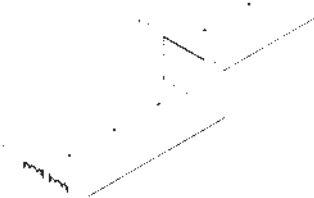

SJS provides a solid trafficable solution to transitions along and over curbs.

Typical SJS Usage

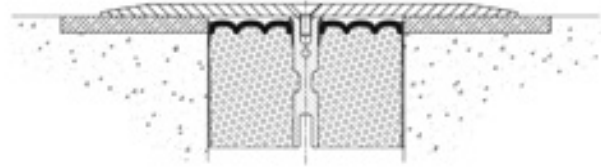

The SJS Seismic Joint System installed flush with the joint surface.

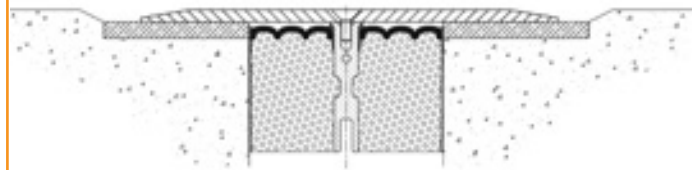

SJS installed recessed from the deck or road surface lowering the coverplate to the traffic surface height. The Emcrete elastomeric nosing material works to level the coverplate as well as to absorb and attenuate sound.

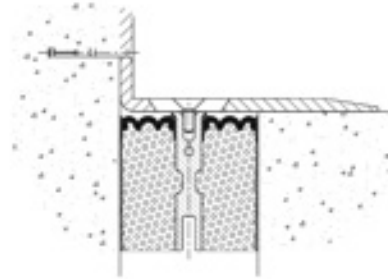

Installation can also be made at deck-to-wall conditions.

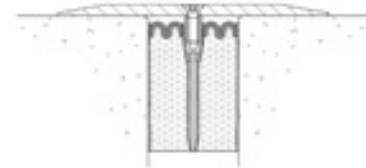

SJS is now available for joint sizes as small as 2" (50mm).

Standard CAD/BIM details are available online at www.emseal.com. For application specific CAD details contact Sika Emseal directly.

EMSEAL JOINT SYSTEMS, LTD 25 Bridle Lane, Westborough, MA 01581 USA
EMSEAL, LLC 111 Royal Group Crescent, Woodbridge, ON L4H 1X9 Canada

PH: 508-836-0280 FX: 508-836-0281
PH: 416-740-2090 FX: 416-740-0233



A SIKA COMPANY

SJS-FR Fire-Rated Seismic Joint System

▼ FIRE-RATED

DECKS Solid Slab

Watertight by design®

US Patents: 10,787,805 10,787,806 9,689,157 9,689,158 8,813,450 C1 8,813,449 C1 8,341,908

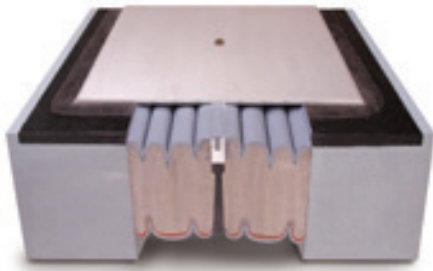

SJS-FR1 and SJS-FR2 are fire-rated, watertight expansion seals which are designed for larger gaps. Their topping coverplate makes them the best solution for applications such as parking decks, stadium concourses and seating levels, interior and exterior floors, and other locations where larger or seismic gaps need a fire-rated, watertight, traffic-bearing expansion joint.

SJS-FR1 and **SJS-FR2** are UL/ULC certified (2079) fire-rated, watertight, high-movement, sound-dampened systems for large and seismic expansion joint gaps. Designed for use in fire-rated concrete decks/floors, interior or open air slabs, treads and risers, in both new or retrofit construction.

Installed from floor/deck surface above allowing for easier installation without compromising continuity of the fire-barrier from obstructions (columns, HVAC, electrical, plumbing, etc.)

SJS-FR1 and SJS-FR2 have all of the performance advantages of the SJS System with the addition of a built-in UL-certified 1-hour (SJS-FR1) or 2-hour (SJS-FR2) fire rating. They are constructed of fire-retardant foam with an intumescent coating on the non-traffic underside. The top provides a watertight seal. The topping coverplate provides a durable trafficable surface.

- 1-hour or 2-hour UL/ULC-certified fire-rated
- Built-in fire-rating
- Eliminates the need for fire-blankets or gutters
- Watertight
- Installed from above floor/deck
No lifts or holding labor needed
- Easy installation with non-invasive anchoring
- No hard metal-to-concrete connections
- Aluminum or stainless steel coverplates available
- Coverplate is easy to install with self-locating, vibration-dampening screws
- Movement of +/- 50% (Total 100%) of nominal size

SJS-FR Sizing*

Joint Size at Mean T°F	Depth of Seal
Inches (mm)	Inches (mm)
4 (100)	6 (150)
5 (125)	6 (150)
6 (150)	6 (150)
7 (175)	6 (150)
8 (200)	6 (150)
9 (225)	6 (150)
10 (250)	6 (150)

Sizes are available in nominal sizes from 2" to 10". Nominal size is equivalent to joint at mean temperature.

SJS-FR1 1-hour fire-rated
SJS-FR2 2-hour fire-rated

*Joint sizing of 2" (50mm) through 3 1/2" (90mm) are also available. For performance specifications please consult Sika Emseal.



SJS-FR1
UL Systems
FF-D-1091, FF-D-2014, FW-D-1079, FW-D-2007
FF-D-1092, FF-D-2015, FW-D-1080, FW-D-2008
ULC System
JF140, JF149, JF142, JF150

Typical SJS-FR Usage

Illustrations of 4" (100mm) and larger.

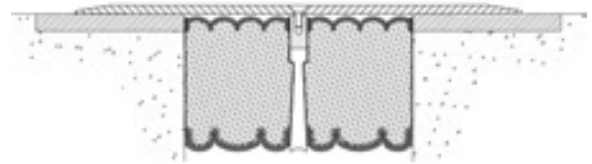

The SJS-FR System with surface blockouts built-up with Emseal's Emcrete nosing material. Beneath the coverplate, the nosing material acts as a leveling course and a sound-absorbing buffer. The coverplate can sit proud of the deck or recessed to be flush with the deck.

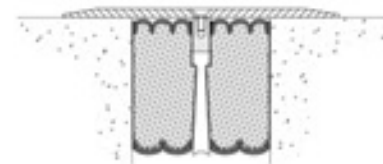

The SJS-FR System is a highly trafficable UL-certified fire-rated expansion joint for larger gaps of 4-inches (100mm) to 10-inches (250mm). Surface-mount or recessed coverplate is available in aluminum or stainless steel.

Standard CAD/BIM details are available online at www.emseal.com. For application specific CAD details contact Sika Emseal directly.

EMSEAL JOINT SYSTEMS, LTD 25 Bridle Lane, Westborough, MA 01581 USA
EMSEAL, LLC 111 Royal Group Crescent, Woodbridge, ON L4H 1X9 Canada

PH: 508-836-0280
PH: 416-740-2090

FX: 508-836-0281
FX: 416-740-0233



A SIKA COMPANY

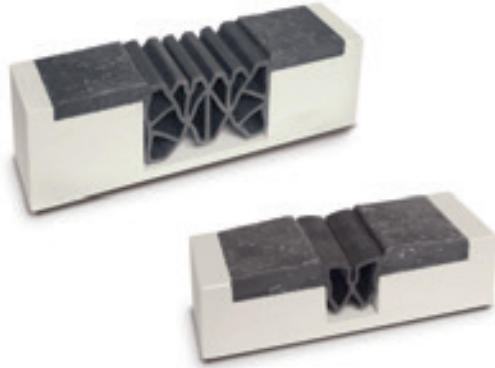

Thermaflex provides a durable expansion joint which will stand up to direct traffic pressure. Factory-welded transitions are engineered to accommodate changes in plane over curbs, and in treads and risers on stadiums.

Thermaflex® is a traffic-durable membrane/nosing system. The gland used in the system becomes integral with the deck as the nosing material penetrates the perforations in the gland, encapsulates the flanges, and bonds to the concrete.

- Watertight
- Double-cell or multi-cell glands
- Heat weldable Santoprene gland
- Factory-fabricated transitions and terminations
- Cold-applied nosing is self-curing
- Nosing material is a two-part polyurethane reinforced with silica-free aggregate
- Aggregate loading is conservatively maintained not to exceed two parts aggregate to one part resin by weight
- Nosing material is easily troweled
- Durable under vehicular traffic and extreme weather conditions

Thermaflex Sizing

Model No.	Installation Width			Blockout Dimensions (Each side of joint gap)	
	Min	Preferred	Max		
TM 1.5	1 in (25mm)	1 1/4 in (30mm)	2 in (50mm)	3/4 in x 3 in	(19mm x 75mm)
TM 2.5	1 1/4 (30)	2 1/4 (55)	2 3/4 (70)	3/4 x 3	(19 x 75)
TCR 300	1 7/8 (47)	2 1/8 (53)	2 3/4 (70)	3/4 x 3 1/2	(19 x 90)
TCR 400	2 1/4 (55)	2 3/4 (70)	3 3/4 (95)	3/4 x 3 1/2	(19 x 90)
TCR 500	3 (75)	3 1/2 (90)	4 3/4 (120)	3/4 x 3 1/2	(19 x 90)
TCR 600	4 1/2 (115)	4 3/4 (120)	5 1/2 (140)	3/4 x 3 1/2	(19 x 90)

For size variations or information please consult Sika Emseal technical services

Typical Thermaflex Usage



Thermaflex is constructed of extruded thermoplastic Santoprene® rubber sealing glands with punched flanges embedded in a high-strength, flexible, impact-absorbing elastomeric nosing.

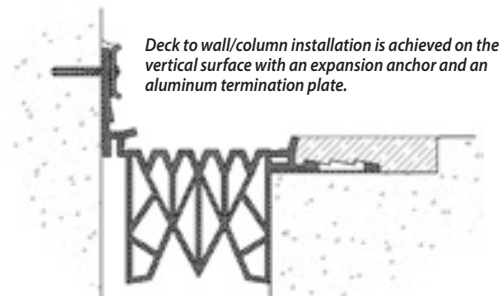

Deck to wall/column installation is achieved on the vertical surface with an expansion anchor and an aluminum termination plate.

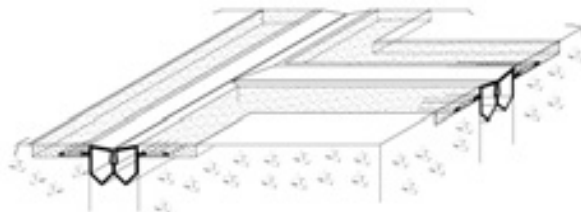

Sealing glands are heat-weldable allowing for changes in direction or plane while maintaining watertightness. Factory-fabricated transitions allow for ease of installation. EMSEAL manufactures its transitions both within the technology and transitions made in the vertical plane between dissimilar Emseal technologies to be watertight.

Standard CAD/BIM details are available online at www.emseal.com. For application specific CAD details contact Sika Emseal directly.

EMSEAL JOINT SYSTEMS, LTD 25 Bridle Lane, Westborough, MA 01581 USA
EMSEAL, LLC 111 Royal Group Crescent, Woodbridge, ON L4H 1X9 Canada

PH: 508-836-0280
PH: 416-740-2090

FX: 508-836-0281
FX: 416-740-0233



A SIKA COMPANY



Migutan FP110 and **FP155** are unique designs incorporating side membrane sheets which integrate with the deck waterproofing system to form a continuous, completely watertight system. MIGUTAN is the only system of its kind with a 20-year track record and tens of thousands of feet installed and functioning. MIGUTAN is the most configurable, reliable, split-slab expansion joint in the industry.

- Watertight
- Exceptional durability under vehicular traffic and extreme weather conditions
- Can be used below grade or on decks
- Heavy-duty positive interlocking aluminum side rails
- Steel side legs available
- Stainless steel gland-retaining capping strips
- Sealing insert and side flashing sheet are heat-weldable thermoplastic rubber (TPR)
- Factory fabricated tees, crosses, directional changes, column details, terminations and changes in plane
- Leg heights from 1" (25mm) to 12" (300mm) as well as low leg height versions
- Available with integrated coverplate



Leg heights from 1" (25mm) to 12" (300mm) accommodate pavers, asphalt, concrete and other wear-course toppings allowing for exceptional durability under vehicular traffic and extreme weather and temperature conditions.



The Migutan sealing insert and side flashing sheets are made of heat-weldable thermoplastic rubber. This ensures continuity of seal through transitions in plane and direction as well as at terminations. The flashing sheets are embedded in and encapsulated by the deck waterproofing membrane. The result is a static integration of the joint and the waterproofing that will not fail from cyclical movement across the joint.

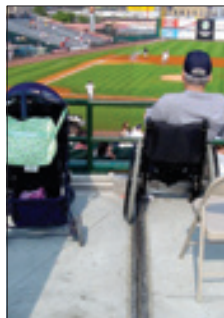

The Migutan design provides watertight joints over occupied spaces below such as stadiums. It also provides for a pedestrian-friendly and accessible surface.

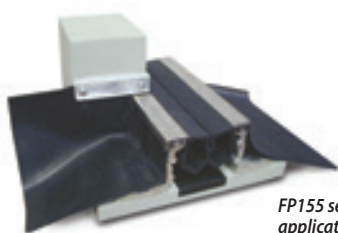

FP155 seen in deck-to-wall application at a column transition.

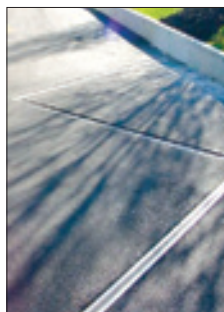

Positive interlocking metal rails (or alternative stainless steel pins) eliminate misalignment between adjoining sections. This method has proven successful with tens of thousands of feet installed and functioning over the past 20 years. Factory-fabricated directional changes ensure continuity of seal.

Certain split-slab waterproof applications can use Emseal's RoofJoint as part of the expansion joint system. See page 35 for more details or contact Sika Emseal.

Standard CAD/BIM details are available online at www.emseal.com. For application specific CAD details contact Sika Emseal directly.

EMSEAL JOINT SYSTEMS, LTD 25 Bridle Lane, Westborough, MA 01581 USA
EMSEAL, LLC 111 Royal Group Crescent, Woodbridge, ON L4H 1X9 Canada

PH: 508-836-0280
PH: 416-740-2090

FX: 508-836-0281
FX: 416-740-0233



A SIKA COMPANY

Migutan FP110

Model No.	Leg Height	Max. Joint Gap at Mean T°F	Movement Range	Total Movement	Overall Width System at Mean Temp	Exposed Width System at Mean Temp					
FP110/25	1 in (25mm)	2 3/8 in (65mm)	See Below	See Below	9 in (225mm)	See Below					
FP110/45	1 3/4 (45)										
FP110/60	2 3/8 (60)										
FP110/80	3 1/8 (80)										
FP110/95	3 3/4 (95)										
FP110/115	4 1/2 (115)										
FP110/130	5 1/8 (130)										
FP110/150	5 7/8 (150)										
FP110/165	6 1/2 (165)						3 in (75mm)	+1 1/4 in (+30mm) -1 1/4 in (-30mm)	2 1/2 in (60mm)	9 3/8 in (237mm)	4 3/8 in (112mm)
FP110/185	7 1/4 (185)										
FP110/200	7 7/8 (200)										
FP110/220	8 5/8 (220)										
FP110/235	9 1/4 (235)										
FP110/255	10 (255)										
FP110/270	10 5/8 (270)										
FP110/290	11 1/2 (290)										
FP110/305	12 (305)										

For size variations or information please consult Sika Emséal technical services. Visit www.emseal.com
 For sizes above 150mm: Intended for non-vehicular-traffic plaza decks. Extra-high leg heights accommodate thick overlay systems and topping slabs. These models are supplied with extra-long (double-width) side sheets to ensure proper integration with deck waterproofing.

Migutan FP155

Model No.	
FP155	Available in same leg heights as the FP110 (see chart above) Migutan Sika Emséal for joint gap and performance specifications.

Typical Migutan Usage

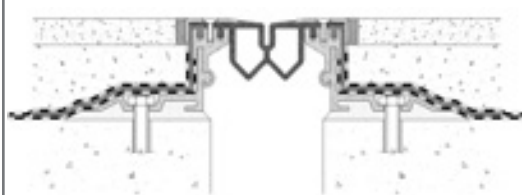

In deck-to-deck applications, Migutan is ideal for plaza and podium decks, stadium concourses, arrival roadways, and anywhere water-proofed split slabs are designed.

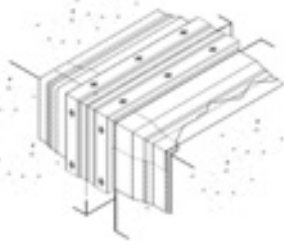

Factory-fabricated corners and transitions are part of the Migutan system. Each change in plane or direction is constructed from field-supplied measurements to create a custom, watertight transition within the Migutan system or where the joint requirement changes to other Emséal technologies.

Typical Migutan Usage

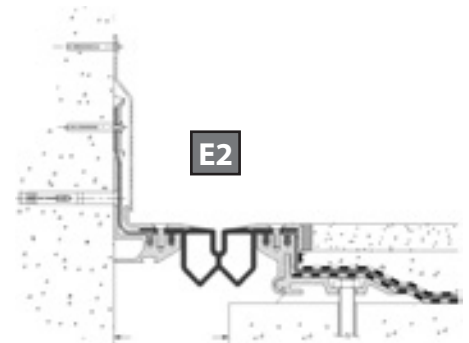

Emséal offers numerous options for Migutan applications at deck-to-wall conditions as shown here in E2, E3 and E8 configurations. The Emséal technical service team can help you map a Migutan solution to integrate deck-to-deck models to deck-to-wall models, and Migutan can be configured to handle curved expansion joints and other hard-to-seal conditions.

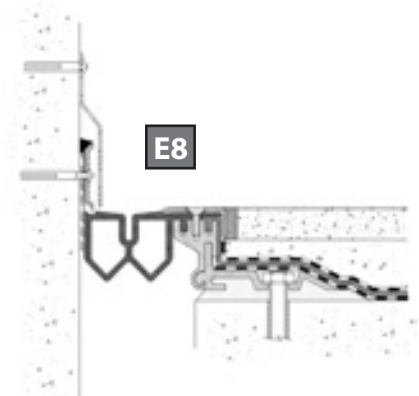
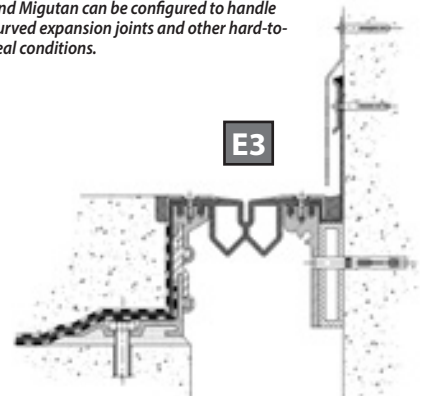

DECKS - Split Slab / Plaza

Standard CAD/BIM details are available online at www.emseal.com. For application specific CAD details contact Sika Emséal directly.

EMSEAL JOINT SYSTEMS, LTD 25 Bridle Lane, Westborough, MA 01581 USA
 EMSEAL, LLC 111 Royal Group Crescent, Woodbridge, ON L4H 1X9 Canada

PH: 508-836-0280 FX: 508-836-0281
 PH: 416-740-2090 FX: 416-740-0233



A SIKA COMPANY

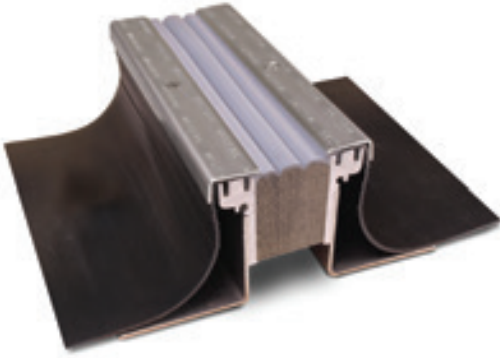

DSM-FP is a versatile expansion joint for split-slab construction as well as split slab-to-solid slab applications. Fabricated transitions from deck to wall, at curbs, sidewalks, parapets, tees, and crosses are available with the DSM-FP.

DSM-FP is a trafficable joint system for plaza decks & split slabs designed to straddle joint gaps up to 4-inches (100mm). DSM-FP expands the use of the DSM System to waterproofed split-slab deck designs through the use of side flashing sheets that integrate with the deck waterproofing membrane.

- Watertight
- Ideally suited to parking decks, stadium concourse, plazas, and other smaller-joint, waterproofed split-slab applications
- Exceptional durability under pedestrian traffic and extreme weather conditions
- Stainless steel flashing sheet capping strips
- Side flashing sheets are heat-weldable thermoplastic rubber (TPR)
- Factory fabricated changes in plane and direction
- Steel side legs available in many heights
- Aluminum or stainless steel coverplates available
- New construction or retrofit of failed older construction
- Movement of +50% and -50% (Total 100%) of nominal size

DSM-FP Sizing

Joint Size at Mean T°F	Depth of Seal
Inches (mm)	Inches (mm)
1/2 (12)	1 3/4 (45)
3/4 (20)	1 3/4 (45)
1 (25)	2 (50)
2 (50)	2 1/2 (65)
3 (75)	3 1/4 (80)
4 (100)	4 (100)

DSM-FP sizes are available in 1/4" increments in nominal sizes from 1" to 4". Consult Sika Emseal for larger sizes. Nominal size is equivalent to joint gap size at mean temperature.

Typical DSM-FP Usage

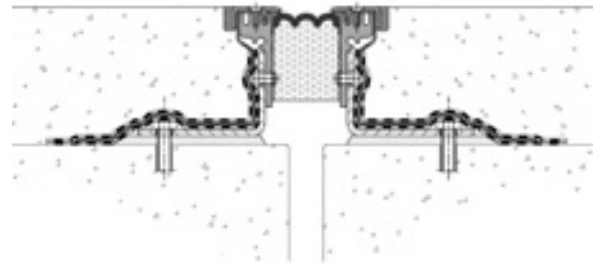

DSM-FP is an effective watertight expansion joint for deck-to-deck expansion gaps in split-slab construction. The topping slab connections are made to the DSM-FP mounting leg. The split-slab connection incorporates an integral waterproofing flashing sidesheet embedded between layers of the deck waterproofing membrane on the structural slab and beneath the topping slab.

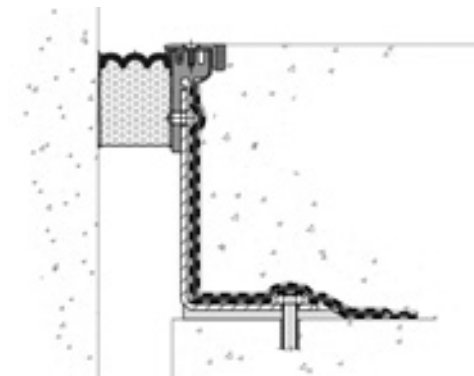

DSM-FP is also an effective watertight expansion joint which can bridge split-slab and solid-slab construction. The connection to solid-slab construction is made directly to the slab substrate. The split-slab connection is made to the DSM-FP mounting leg. An effective solution in deck-to-deck and (as shown here) in deck-to-wall.

DECKS - Split Slab / Plaza

Standard CAD/BIM details are available online at www.emseal.com. For application specific CAD details contact Sika Emseal directly.

EMSEAL JOINT SYSTEMS, LTD 25 Bridle Lane, Westborough, MA 01581 USA
EMSEAL, LLC 111 Royal Group Crescent, Woodbridge, ON L4H 1X9 Canada

PH: 508-836-0280 **FX:** 508-836-0281
PH: 416-740-2090 **FX:** 416-740-0233



A SIKA COMPANY

Emshield® DFR-FP

▼ FIRE-RATED

DECKS Split Slab

Watertight by design®

US Patents: 10,934,702 10,934,704 10,941,562 9,670,666 9,637,915 9,068,297 8,739,495 C1

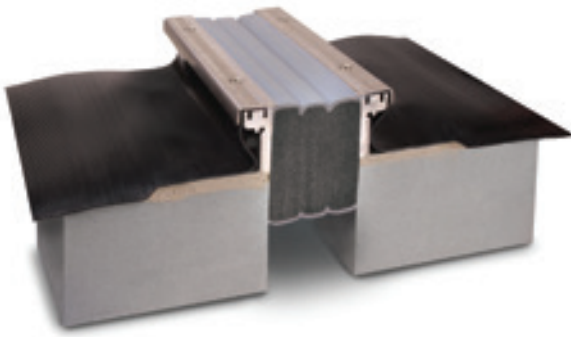

Heat-weldable TPR sidesheets (left) integrate with the deck waterproofing system. Silicone bellows provide a watertight top surface (center) of Emshield UL/ULC fire-rated foam. The top and bottom of each foam stick is coated with traffic-grade silicone (right).

Emshield® DFR-FP is a single unit fire-rated trafficable joint system for plaza decks & split slabs designed to straddle joint gaps up to 4-inches (100mm). DFR-FP expands the use of Emshield DFR to waterproofed split-slab deck designs through the use of side flashing sheets that integrate with the deck waterproofing membrane. Emshield DFR-FP has been certified by Underwriters Laboratories (UL) to the rigors of UL and ULC 2079.

Installed entirely from the deck surface above -- allowing for easier installation without compromising continuity of the fire-barrier from obstructions (e.g. columns, HVAC, electrical, plumbing, etc.) DFR-FP provides a watertight, clean handling, UV stable, low-temperature-flexible, high-temperature-stable, traffic durable fire-rated joint seal.

- Watertight
- Ideally suited to parking decks, plazas, stadium concourses, and other smaller-joint, fire-rated waterproofed split-slab applications
- Built-in UL-certified fire-rating
- Exceptional durability under pedestrian traffic and extreme weather conditions
- Eliminates traditional need for fire-blankets or gutters
- Stainless steel flashing sheet capping strips
- Side flashing sheets are heat-weldable thermoplastic rubber (TPR)
- Factory fabricated changes in plane and direction
- Steel side legs available in many heights
- New construction or retrofit of failed older construction
- Movement of +/- 50% (Total 100%) of nominal size

DFR-FP Sizing

Joint Size at Mean T°F	Depth of Seal
Inches (mm)	Inches (mm)
1/2 (12)	5 (125)
3/4 (20)	5 (125)
1 (25)	5 (125)
2 (50)	5 (125)
3 (75)	5 (125)
4 (100)	5 (125)

DFR-FP sizes are available in 1/4" increments in nominal sizes from 1" to 4". Nominal size is equivalent to joint gap size at mean temperature. Leg heights are available from 1-inch (25mm) to 3-inches (75mm).



UL Systems
FF-D-0081, FF-D-1095
FW-D-0058, FW-D-1081

ULC Systems
JF147, JF151

Typical DFR-FP Usage

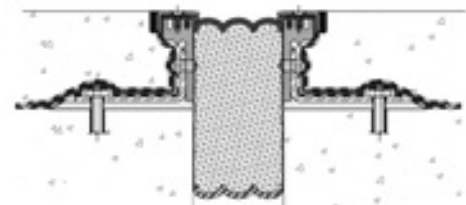

DFR-FP offers a fire-rated waterproof solution to split-slab deck-to-deck situations. Shown here in a 4-inch expansion gap bridged with a fire-rated expansion joint system. The split-slab connection incorporates an integral waterproofing flashing sidesheet embedded between layers of the deck waterproofing membrane on the structural slab and beneath the topping slab.



DFR-FP is an effective fire-rated watertight expansion joint which can bridge split-slab to solid-slab construction. The connection to solid-slab construction is made directly to the slab substrate. The split-slab connection is made to the DFR-FP mounting leg.

DECKS – Split Slab / Plaza
UL / ULC FIRE-RATED



A SIKA COMPANY

Standard CAD/BIM details are available online at www.emseal.com. For application specific CAD details contact Sika Emseal directly.

EMSEAL JOINT SYSTEMS, LTD 25 Bridle Lane, Westborough, MA 01581 USA
EMSEAL, LLC 111 Royal Group Crescent, Woodbridge, ON L4H 1X9 Canada

PH: 508-836-0280
PH: 416-740-2090

FX: 508-836-0281
FX: 416-740-0233



SJS-FP installation consists of the two sub-assemblies which make up the system. The mounting leg assembly and integral waterproof sidesheets are installed onto the structural slab and integrated with the deck waterproofing system. The watertight, precompressed SJS assembly is installed between the rails of the mounting leg assembly and then capped with an aluminum or stainless steel coverplate.

SJS-FP expands the use of the SJS System to waterproofed split-slab deck designs through the use of side flashing sheets that integrate with the deck waterproofing membrane. The system is made up of two sub-assemblies which include the structural-slab mounted supporting legs with integral waterproofing side sheets and the joint sealing and coverplate assembly.

- Watertight
- Ideally suited to stadium concourse, roadway, plaza, and other large-joint, waterproofed split-slab applications
- Exceptional durability under vehicular traffic and extreme weather conditions
- Stainless steel flashing sheet capping strips
- Side flashing sheets are heat-weldable thermoplastic rubber (TPR)
- Factory fabricated changes in plane and direction
- Steel side leg available in many heights
- Aluminum or stainless steel coverplates available
- No hard connection between coverplate and concrete substrate
- The quietest coverplate system available
- Self-locking, vibration dampened screws
- Movement of +50% and -50% (Total 100%) of nominal size

SJS-FP Sizing

Joint Size at Mean T°F		Depth of Seal	
Inches	(mm)	Inches	(mm)
2	(50)	3	(75)
2 1/2	(65)	3	(75)
3	(75)	3	(75)
3 1/2	(90)	3	(75)
4	(100)	4	(100)
5	(125)	4	(100)
6	(150)	4	(100)
7	(175)	4	(100)
8	(200)	4	(100)
9	(225)	5	(125)
10	(250)	5	(125)
11	(275)	5	(125)
12	(300)	5	(125)
13	(325)	5	(125)
14	(350)	5	(125)
15	(372)	5	(125)
16	(400)	5	(125)

SJS-FP can straddle structural slab gaps from 1" to 16". In the topping slab, sizes are available in nominal sizes from 2" to 16". Consult Sika Emseal for larger sizes. Nominal size is equivalent to joint gap size at mean temperature.

Typical SJS-FP Usage

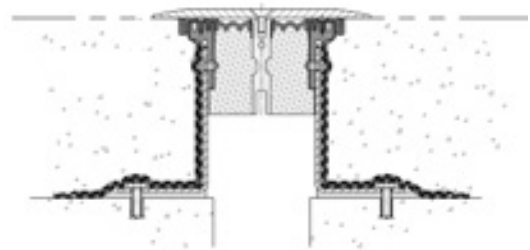

The SJS-FP system features the addition of side flashing sheets which are fully encapsulated in a static, watertight integration with the deck's buried waterproofing membrane.

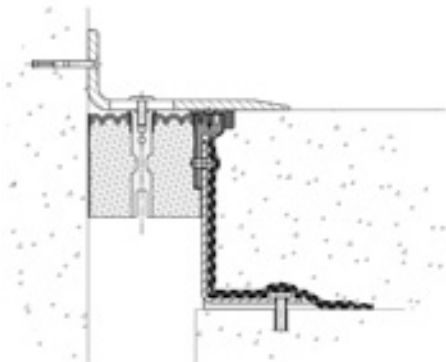

Watertight configurations and factory-fabricated transitions and terminations are available for deck-to-wall and other conditions.

Standard CAD/BIM details are available online at www.emseal.com. For application specific CAD details contact Sika Emseal directly.

EMSEAL JOINT SYSTEMS, LTD 25 Bridle Lane, Westborough, MA 01581 USA
EMSEAL, LLC 111 Royal Group Crescent, Woodbridge, ON L4H 1X9 Canada

PH: 508-836-0280 **FX:** 508-836-0281
PH: 416-740-2090 **FX:** 416-740-0233



A SIKA COMPANY

SJS-FP-FR

▼ FIRE-RATED

DECKS Split Slab

Watertight by design®

US Patents: : 10,787,805 10,787,806 9,689,157 9,689,158 8,813,450 C1 8,813,449 C1 8,341,908

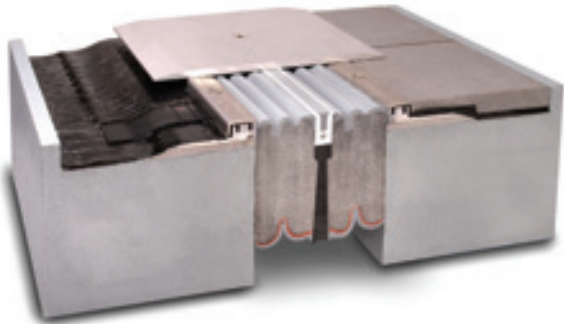

Heat-weldable TPR sidesheets (left) integrate with the deck waterproofing system. Watertight silicone bellows (center) sit under the trafficable coverplate. Spline (right) continues down through fire-retardant intumescent coating and silicone outer coating which line the SJS-FP-FR underside.

The **SJS-FP-FR System** is designed to provide a UL/ULC-certified fire-rated, watertight, trafficable joint system for use in seismic and large joint openings in decks of split-slab design. SJS-FP-FR expands the use of the SJS-FR System through side flashing sheets that integrate with the deck waterproofing membrane.

The primary use is for plaza decks & split slabs designed to straddle joint gaps from 4-inches (100mm) to 10-inches (250mm). SJS-FP-FR has been certified by Underwriters Laboratories (UL) to the rigors of UL and ULC 2079.

Installation is entirely from the deck surface above -- allowing for easier installation without compromising continuity of the fire-barrier from obstructions (e.g. columns, HVAC, electrical, plumbing, etc.)

- Watertight
- Built-in UL 2079-certified 1-hour or 2-hour fire-rating
- Eliminates traditional need for fire-blankets or gutters
- Exceptional durability under pedestrian traffic and extreme weather conditions
- Easy installation with non-invasive coverplate anchoring
- Side flashing sheets are heat-weldable thermoplastic rubber (TPR)
- Aluminum or stainless steel coverplates available
- Coverplate is easy to install with self-locating, vibration-dampening screws
- New construction or retrofit of failed older construction
- Movement of +50% and -50% (Total 100%) of nominal size

SJS-FP-FR Sizing*

Joint Size at Mean T°F	Depth of Seal
Inches (mm)	Inches (mm)
4 (100)	6 (150)
5 (125)	6 (150)
6 (150)	6 (150)
7 (175)	6 (150)
8 (200)	6 (150)
9 (225)	6 (150)
10 (250)	6 (150)

SJS-FP-FR sizes are available in 1" increments in nominal sizes from 2" to 10". Nominal size is equivalent to joint gap size at mean temperature. Leg heights are available from 1-inch (25mm) to 3-inches (75mm).



UL Systems
FF-D-1093, FF-D-2016
FF-D-1096, FF-D-2018, FW-D-2009

ULC Systems
JF143, JF148, JF152

*Joint sizing of 2" (50mm) through 3 1/2" (90mm) are also available. For performance specifications please consult Sika Emseal.

Typical SJS-FP-FR Usage

Illustrations of 4" (100mm) and larger.

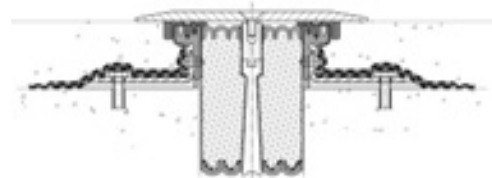

SJS-FP-FR offers a fire-rated waterproof solution to split-slab deck-to-deck situations (above). Shown here is an expansion gap bridged with a fire-rated expansion joint system installed in a concrete substrate.

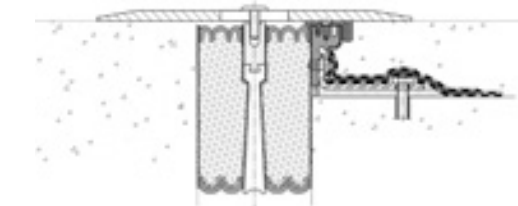

SJS-FP-FR can also fit applications of split-slab decks to solid-slab decks. The back pressure of SJS foam provides the required anchoring and sealing against the solid-slab side (left) of the expansion gap.

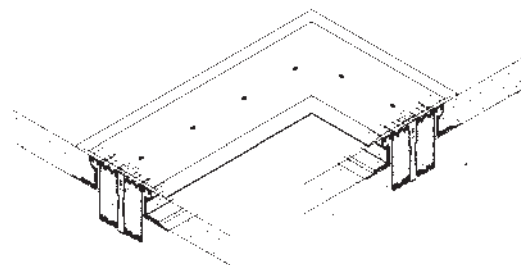

Watertight trafficable transitions are also achievable with the SJS-FP-FR system. Shown here is a 90-degree horizontal transition.

DECKS - Split Slab / Plaza
UL / ULC FIRE-RATED



A SIKA COMPANY

Standard CAD/BIM details are available online at www.emseal.com. For application specific CAD details contact Sika Emseal directly.

EMSEAL JOINT SYSTEMS, LTD 25 Bridle Lane, Westborough, MA 01581 USA
EMSEAL, LLC 111 Royal Group Crescent, Woodbridge, ON L4H 1X9 Canada

PH: 508-836-0280
PH: 416-740-2090

FX: 508-836-0281
FX: 416-740-0233



Emcrete has a wide range of applications. It can be used as a trafficable nosing under Sika Emseal's SJS system. It is used to form a durable header at the edges of expansion gaps. Emcrete can also be used as a rugged quick-setting patching material.

Emcrete is a flexible, durable, high-impact elastomeric concrete material. It is a bio-based, non-hazardous, extremely low VOC product primarily used as a component of an expansion joint assembly either to fill blockouts on each side of an expansion joint gap, to repair a damaged expansion joint gap edge, as an impact absorbing nosing, or as a fast curing patching material for potholes or spalls on concrete roadways, parking surfaces, bridges, runways, etc.

Emcrete is comprised of a two-component polyurethane resin mixed with sand and chopped fiberglass aggregates. The sand imparts compressive strength. The fiber provides cross-linked reinforcement while, in combination with the sand, adds body to the polyurethane resin.

- Repair spalled gap edges in high load-bearing applications.
- Elastomeric concrete where the possibility of spalling or cracking is a concern for standard concrete.
- As a leveling bed and sound dampening support of the coverplates of the Sika Emseal SJS Seismic Joint Systems.
- As an impact-absorbing header material behind the rails of Sika Emseal FP systems or securing the wings in Emseal's Thermaflex expansion joints.



Emcrete in easy to pour parts allows you to quickly field mix for your specific application.

Typical Emcrete System Usage

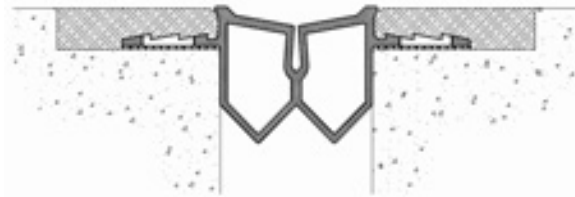

Emcrete used as a durable header in a blockout to anchor Emseal's Thermaflex membrane expansion joint system bonding it to the substrate's concrete surfaces.

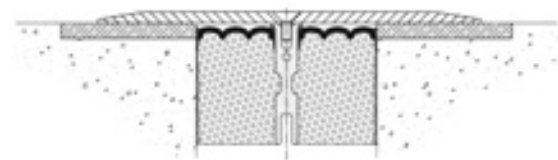

Emcrete used as an impact absorbing nosing material with Emseal's SJS system. Its elasticity also helps to reduce coverplate noise common with constant vehicular traffic.

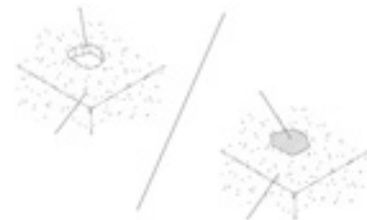

Emcrete used in many applications calling for a long lasting, quick setting patching material that handles pedestrian and vehicular traffic.

Standard CAD/BIM details are available online at www.emseal.com. For application specific CAD details contact Sika Emseal directly.

EMSEAL JOINT SYSTEMS, LTD 25 Bridle Lane, Westborough, MA 01581 USA
EMSEAL, LLC 111 Royal Group Crescent, Woodbridge, ON L4H 1X9 Canada

PH: 508-836-0280
PH: 416-740-2090

FX: 508-836-0281
FX: 416-740-0233



A SIKA COMPANY

BG System

WALLS Below Grade

Watertight by design®

US Patents: 9,850,662 9,322,163 B1 10,851,542

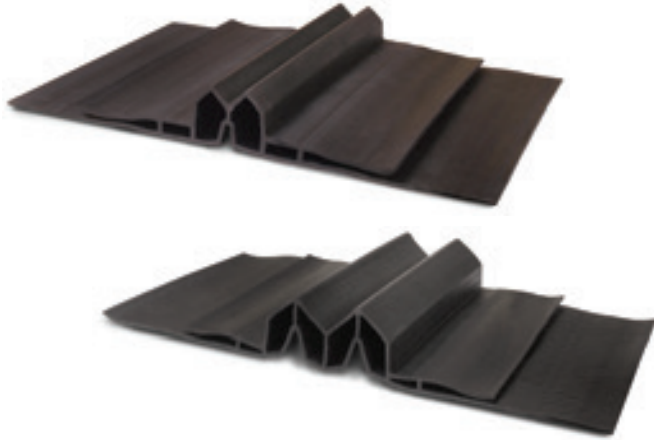

The **BG System** is a heavy-duty, double-celled, extruded, heat-weldable rubber gland flanked by integral side flashing sheets. It is combined in the field with a waterproofing membrane and accessories offered by the waterproofing membrane manufacturer for use in blind forming conditions. The BG System is the only expansion joint system designed for blind side as well as positive side applications.

- Integration of the below-grade waterproofing membrane and expansion joint system on the positive side of the wall or floor
- Ensures movement at the joint gap is properly accommodated
- Sizes:
BG-0200: 2-3 inches | 50-75mm
BG-0400: 3-5 inches | 75-125mm
BG-0600: 5-7 inches | 125-175mm

• **Applications include:**

Tunnel joints: Underside of floor-slabs, and continuing up and over wall and roof joints, blind-side and/or backfilled applications

Under the floor-slab and the walls of a blind-side formed foundation or tunnel

Walls of a blind-side formed foundation and backfilled below-grade walls

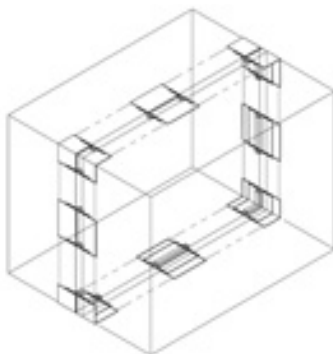

In this typical tunnel application, BG is used under the slab and up the blind-side formed walls. At the transition above the blind-side walls, BG wraps over the roof in softscapes on the freestanding walls and across the roof or plaza deck in hardscape wear courses.



Once the BG system is installed to the mud-slab or lagging, concrete is cast to encapsulate the waterproofing membrane and BG resulting in an integrated watertight system which accommodates movement at the joint gap.

Typical BG System Usage

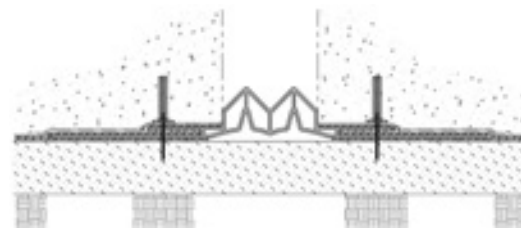

BG System can be installed in blind-side applications in walls and foundation floors (BG-0400 shown). Here the foundation floor under-slab is cast onto waterproofing membrane and BG System.

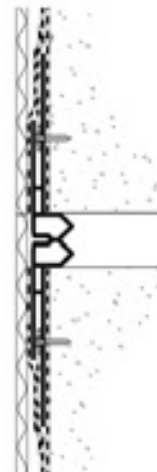

BG System in positive-side wall installation (BG-0200 shown). Dual-level flanges ensure positive integration with below-grade waterproofing membrane.

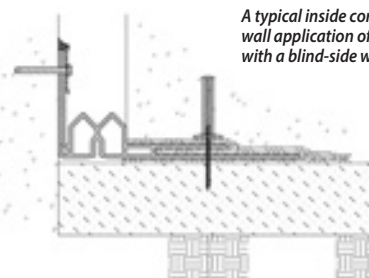

A typical inside corner foundation floor-to-wall application of the BG System integrated with a blind-side waterproofing membrane.

For specifications and limitations see BG System at www.emseal.com or contact Sika Emseal.



A SIKA COMPANY

Standard CAD/BIM details are available online at www.emseal.com. For application specific CAD details contact Sika Emseal directly.

EMSEAL JOINT SYSTEMS, LTD 25 Bridle Lane, Westborough, MA 01581 USA
EMSEAL, LLC 111 Royal Group Crescent, Woodbridge, ON L4H 1X9 Canada

PH: 508-836-0280 FX: 508-836-0281
PH: 416-740-2090 FX: 416-740-0233

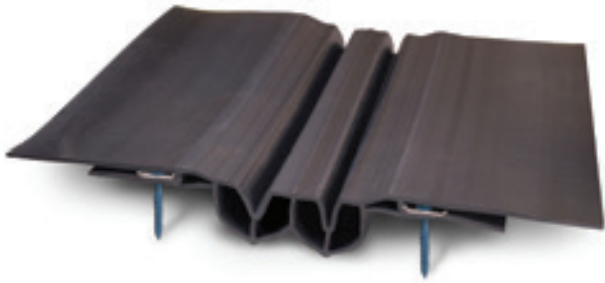

RoofJoint RJ-0400 Black



RoofJoint RJ-0400 Reflective White

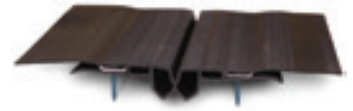

RoofJoint RJ-0200 Black



RoofJoint RJ-0200 Reflective White

Sika Emseal's RoofJoint, roof expansion joint, is a dual-seal, double-flanged, extruded thermoplastic rubber system for sealing expansion joints in roofs. Watertightness is achieved through positive integration with the roofing membrane and a purpose-designed system for transitioning between the joint in the roof and joints in walls.

Unique to Sika Emseal's RoofJoint is the double-level flange. This flange configuration facilitates multi-layered, watertight integration with the roofing membrane. The lower flange is welded or adhered to the roof membrane brought up to the joint. A termination bar and anchors mechanically lock the flange to the roof decking or blocking. The upper flange counterflashes the termination bar and underlying membrane ensuring that penetrations made by the attachment of the termination bar are completely sealed. The upper flange is further flashed to the roofing membrane by means of the roofing manufacturers' standard flashing tape or by over-welding a strip of roofing.

RJ-0200 for joint gaps of 2 to 3 inches (50-75mm) with movement capability of 2 1/2 inches (60 mm).

RJ-0400 for joint gaps of 3 to 5 inches (75-125mm) with movement capability of 5 inches (125mm).

RJ-0600 for joint gaps of 5 to 7 inches (125-175mm) with movement capability of 7 inches (175mm).

RJ-0800 for joint gaps of 7 to 9 inches (175-225mm) with movement capability of 9 inches (225mm).

- High movement
- Redundant sealing
- Double-level roof-membrane integration flange
- Redundant fastening—adhesion or welding & termination bar
- Heat welded transitions at tees, crosses, roof-to-wall, etc.
- Watertight transition to Seismic Colorseal wall joints
- Uniquely addresses wall joint to roof joint interface
- Available in TPV (to TPO) or NPVC (to PVC) for broadest liquid and sheet membrane compatibility
- TPV available in reflective white color
NPVC available in black or reflective white color

Typical RoofJoint Usage

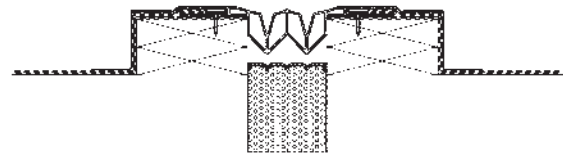

Horizontal Colorseal beneath RoofJoint ensures complete building envelope sealing, ensures thermal insulation, and adds a third water seal to the roof assembly.

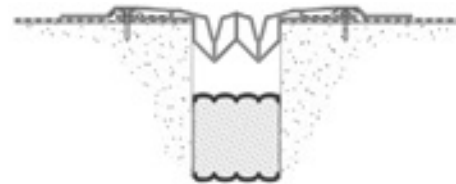

RoofJoint installed over Emshield DFR – 2-hour or 3-hour UL/ULC fire-rated expansion joint – provides life safety protection. The non-invasive anchoring of DFR allows it to be placed in the expansion gap under the RoofJoint expansion joint. Additionally it provides R-value for thermal retention.

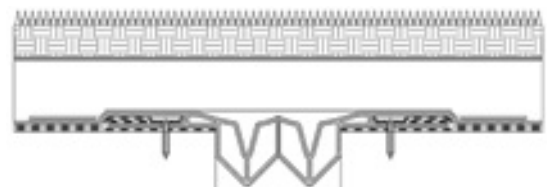

RoofJoint is ideally suited for use in sealing the structural slabs beneath green, vegetative roof assemblies.

Standard CAD/BIM details are available online at www.emseal.com. For application specific CAD details contact Sika Emseal directly.

EMSEAL JOINT SYSTEMS, LTD 25 Bridle Lane, Westborough, MA 01581 USA
EMSEAL, LLC 111 Royal Group Crescent, Woodbridge, ON L4H 1X9 Canada

PH: 508-836-0280
PH: 416-740-2090

FX: 508-836-0281
FX: 416-740-0233



A SIKA COMPANY

RoofJoint Wall Closure

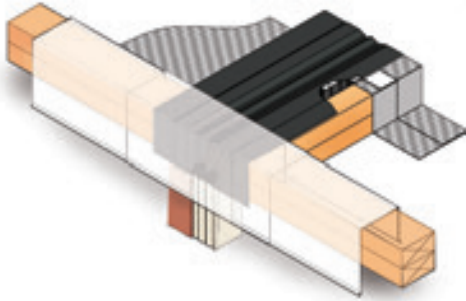

RoofJoint solves the problem of a watertight transition from the roof to the wall expansion joint. The solution lies in the Emseal RoofJoint seated in the joint-gap, a factory welded downturn transition in the RoofJoint gland that is sealed at a ship-lapped 45-degree angle to mate with an interlocking factory-fabricated RoofJoint Wall Closure transition piece. The result is an integrated wall and roof expansion joint system that is watertight.

RoofJoint Split-Slab and Plaza Deck Solutions

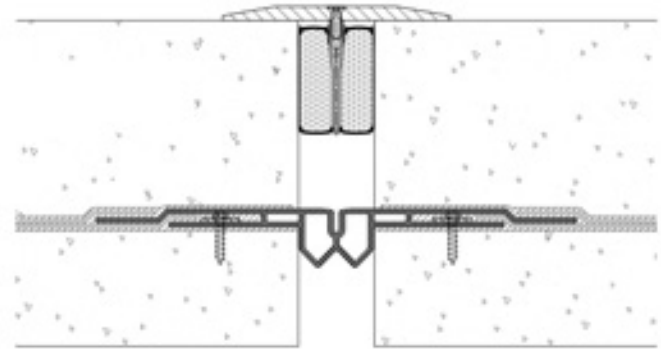

RoofJoint in Hardscaped Plaza Decks

Because RoofJoint is a dual-seal, double-flanged, extruded thermoplastic roof expansion joint system that easily accommodates deck movement, it can also be used in split-slab and plaza decks that sit above occupied space (e.g. sub street-level parking garages).

When drainage or other construction elements may be impeded by the expansion joint protruding above the structural deck elevation, RoofJoint can be utilized to provide a static tie-in into the waterproofing membrane. In these cases an additional expansion joint seal would be needed at the wearing course. SJS is shown above to demonstrate a coverplate system installed at the wearing course. DSM-DS can also be used at the wear course if a coverplate is not required. If a fire-rating is required, Emshield DFR® can be installed directly below the RoofJoint.

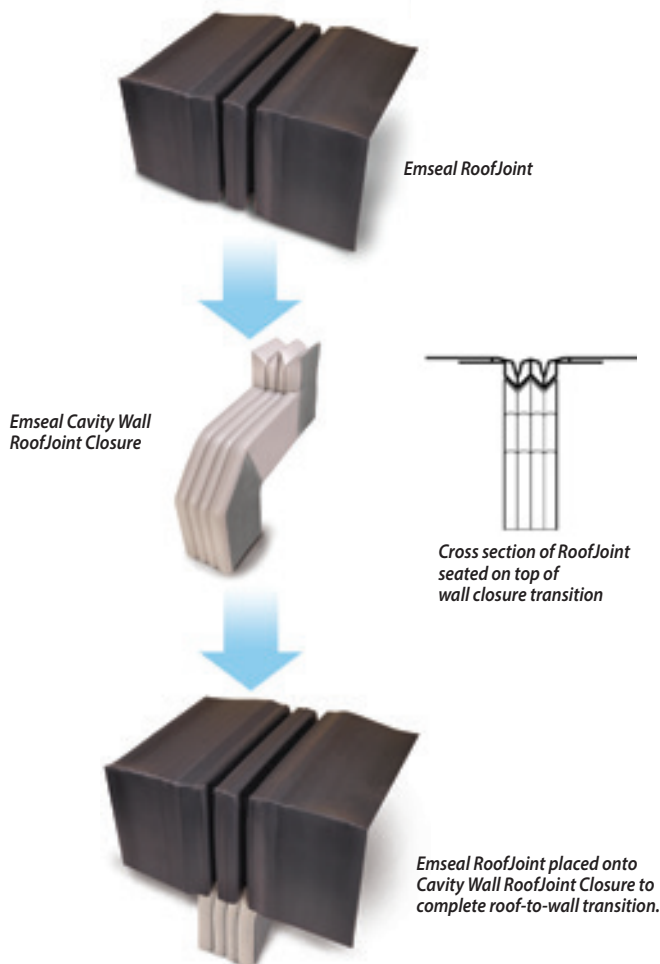

Standard CAD/BIM details are available online at www.emseal.com. For application specific CAD details contact Sika Emseal directly.



Submerseal is manufactured to seal joints which come in contact with chlorinated and contaminated water as found in pools, fountains and wastewater treatment plants. Because its silicone surface meets NSF/ANSI Standard 61 it is applicable for potable water tanks and storage structures.

Watertight Expansion Joint for Continuous Immersion in Chlorinated, Saline or Potable Water and Wastewater Environments

Submerseal® is a water resistant, joint-face-adhered, precompressed, primary seal for retrofit and new structural expansion joints and construction joints where continuous or intermittent immersion or contact with chlorinated water (up to 5 ppm), saline water, potable water or wastewater is planned. Typical applications include swimming pools, fountains, water parks, water features, water tanks, etc.

- Watertight
- Non-invasive anchoring
- Conforms to joint gap irregularities
- Size switching accommodates joint gap variations
- 100% free of wax or asphalt compounds
- NSF/ANSI STANDARD 61 compliant
- Resistant to chlorinated water (up to 5 ppm)
- Resistant to saline water
- Resistant to certain effluent concentrations* (contact EMSEAL)
- Bellows is never under tension during joint movement
- No blockout required
- Movement of +/- 25% (Total 50%)

Submerseal Sizing

Joint Size at Mean T°F	Depth of Seal
Inches (mm)	Inches (mm)
1/2 (12)	1 3/4 (45)
3/4 (20)	1 3/4 (45)
1 (25)	2 1/8 (55)
2 (50)	3 (75)
3 (75)	3 1/2 (90)
4 (100)	4 3/4 (120)

Submerseal sizes are available in 1/4" increments of nominal sizes from 1" to 4". Nominal size is equivalent to joint gap size at mean temperature.

* For specific chemical resistance and expanded usage capabilities contact Sika Emseal for additional submerged products and options.

Typical Submerseal Usage

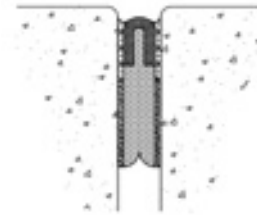

Submerseal is available in sizes to fit gaps as small as 1/2-inch (12mm).

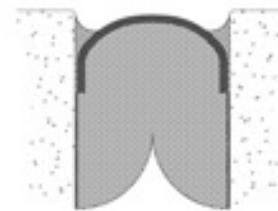

Larger gaps up to 4-inches (10mm), submerged or that come in contact with chlorine or other contaminants, are typical Submerseal applications.

Hydrostatic Head Pressure Resistance

Joint Size	Continuous Immersion Max. Allowable Liquid Depth
Inches (mm)	Feet (meters)
1 (25)	30 (10)
2 (50)	20 (6)
3 (75)	15 (5)
4 (100)	10 (3)

Submerged

Standard CAD/BIM details are available online at www.emseal.com. For application specific CAD details contact Sika Emseal directly.

EMSEAL JOINT SYSTEMS, LTD 25 Bridle Lane, Westborough, MA 01581 USA
EMSEAL, LLC 111 Royal Group Crescent, Woodbridge, ON L4H 1X9 Canada

PH: 508-836-0280 FX: 508-836-0281
PH: 416-740-2090 FX: 416-740-0233



A SIKA COMPANY

US Patent Pending



QuietJoint easily fills in gaps and joints between partitions, walls and windows, head of walls, and other non-moving locations.

Sound, Draft, Heat, Cold, and Dust Blocking Acoustic Joint Filler for Interior Non-moving Joints and Gaps.

QuietJoint® is colorized, versatile and ideally suited to fill gaps between the ends of permanent, semi-permanent, or movable partitions, head-of-wall and other conditions.

QuietJoint is supplied in uncompressed and slightly oversized 2-meter (6.56-foot) and also full-story 10-foot lengths. Installation of QuietJoint is quick and easy requiring no mechanical anchors or epoxies. When installed the material is compressed by hand and squeezed into the gap or opening. The internal backpressure of the material secures it to the joint faces.

The product is composed of a self-extinguishing, fire-retardant*-acrylic-impregnated foam, factory pre-coated with high-quality silicone. QuietJoint makes an excellent sound attenuator which will conform to slight irregularities of gap construction.

- Acoustic dampening –
STC rated 53 (in a STC 56 wall)
OITC rated 38 (in a OITC 38 wall)
- Width sizes from 1" (25mm) to 6" (150mm)
- Thermally insulating (R-value 5.96/inch of depth)
- Quick, easy installation
- Non-invasive anchoring
- Wide range of standard and custom colors
- Conforms to joint gap irregularities
- Size switching accommodates joint gap variations
- UV-stable
- Clean-handling, non-staining
- Won't suffer from compression set

Sound Attenuation STC 53 / OITC 38

Typical QuietJoint Usage



Two-sided SHH for use between opaque walls and partitions.

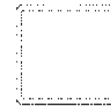

SHG is coated on three-sides for use in glass window-to-wall applications where one containing surface is transparent.

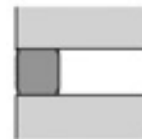

When filling a gap as a single unit, 2-inch QuietJoint displays impressive sound attenuation capabilities - STC 53 in a STC 56 wall and OITC 38 in an OITC 38 wall. It also has an R-value of 5.96 for its 1-inch of depth.



When two units of 2" QuietJoint are installed from both sides of a gap the sound dampening capabilities increase - STC 72 in a STC 72 wall and OITC 60 in an OITC 61 wall. It also has an R-value of 11.92 for its 2-inches of depth.

* QuietJoint is fire-retardant and does not promote the spread of flame or smoke, however it has not been UL-tested for fire-rating.

Standard CAD/BIM details are available online at www.emseal.com. For application specific CAD details contact Sika Emseal directly.

EMSEAL JOINT SYSTEMS, LTD 25 Bridle Lane, Westborough, MA 01581 USA
EMSEAL, LLC 111 Royal Group Crescent, Woodbridge, ON L4H 1X9 Canada

PH: 508-836-0280
PH: 416-740-2090

FX: 508-836-0281
FX: 416-740-0233



A SIKA COMPANY

Interior Products

Sika Emseal offers superior products for interior floors, walls and ceilings to suit a variety of conditions and aesthetic requirements. They are designed and constructed with the highest quality materials and are matched specifically for each installation application. Additional configurations and heights are available (*consult Emseal*). For a complete listing and CAD details of interior joint solutions please visit www.emseal.com.

Interior Floor Joints

MIGUTRANS FSFS Series features heavy duty interlocking all-metal profiles for heavy point loads while the **Migutec FP Series**, **FGH Series** and **FV Series** are designed to bridge various width joint gaps utilizing a robust rubber sealing insert. Also available are **FN Series** in surface mount versions.

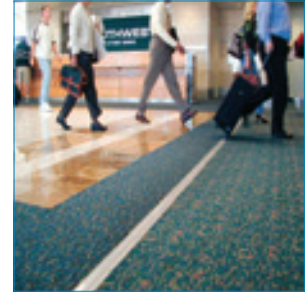
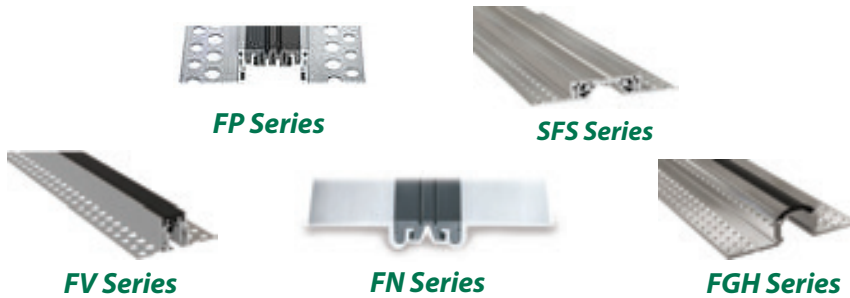

The **Twinsert Series**, is designed for joints sized to seismic conditions and provide solutions for extremely large joint gaps by permitting the insertion of the flooring materials as an inlay between rubber seals or metal inserts.



Interior Wall (and Ceiling) Joints

The wall (and ceiling) selections include easy to install snap-cover all-metal versions such as the **KF Series** featuring rapid spring-anchor fastening in a variety of joint sizes as well as the **FN Series** composed of metal and elastomeric covers.



▼ Fire-Rating Interior Joints

Interior floor or wall expansion joints can be fire-rated when an Emshield UL-certified expansion joint is combined with another interior product. While Emshield expansion joints (WFR, SSW, DFR, SSF) are usually installed as a single expansion joint system, they can be placed in combination to create a dual assembly. The surface product should be backed in the expansion gap with an appropriate fire-rated Emshield foam product. Emshield **DFR** (pg. 18) can be placed under the following floor-mounted surface product series: **FP, FN, FV, FGH,** and **SFS**. The same holds true in walls where Emshield **WFR** (pg. 14) can be placed behind **FN** or **KF** series expansion joints. *Consult EMSEAL for further information.*



A SIKA COMPANY

Standard CAD/BIM details are available online at www.emseal.com. For application specific CAD details contact Sika Emseal directly.

EMSEAL JOINT SYSTEMS, LTD 25 Bridle Lane, Westborough, MA 01581 USA
EMSEAL, LLC 111 Royal Group Crescent, Woodbridge, ON L4H 1X9 Canada

PH: 508-836-0280
PH: 416-740-2090

FX: 508-836-0281
FX: 416-740-0233



Migutec FN 20/12

Joint sizes:
3/4" – 1 1/4" (20 – 30mm)
Movement:
3/16" = + 1/8", -1/16"
(5mm = +3mm, -2mm)

Floors / Walls / Ceilings
Alum/rubber
Surface mount
Standard load rating



Migutec FN 35/15

Joint sizes:
1 3/8" – 1 7/8" (35 – 48mm)
Movement:
3/8" = + 3/16", -3/16"
(10mm = +5mm, -5mm)

Floors / Walls / Ceilings
Alum/elastomeric
Surface mount
Standard load rating



Migutec FV 35/35

Joint sizes:
3/16" – 1 1/4" (5 – 32mm)
Movement:
3/8" = + 3/16", -3/16"
(10mm = +5mm, -5mm)

Floors
Alum/elastomeric
Recess mount
Standard load rating



Migutec FN 50/20

Joint sizes:
2" – 2 1/2" (50 – 65mm)
Movement:
5/8" = + 5/16", -5/16"
(16mm = +8mm, -8mm)

Floors / Walls / Ceilings
Alum/elastomeric
Surface mount
Standard load rating

Sika Emseal offers an extended range of products. For more detailed information and drawings on any products please visit www.emseal.com. For additional products and sizes please contact Sika Emseal directly.

Standard CAD/BIM details are available online at www.emseal.com. For application specific CAD details contact Sika Emseal directly.

EMSEAL JOINT SYSTEMS, LTD 25 Bridle Lane, Westborough, MA 01581 USA
EMSEAL, LLC 111 Royal Group Crescent, Woodbridge, ON L4H 1X9 Canada

PH: 508-836-0280
PH: 416-740-2090

FX: 508-836-0281
FX: 416-740-0233



A SIKA COMPANY

Interior Joints

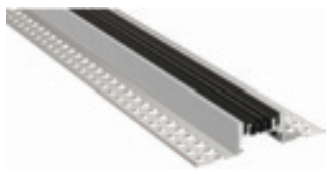

Migutec FP 55/35

Joint sizes:
1/2" – 2" (13 - 50mm)
Movement:
 5/8" = + 5/16", -5/16"
 (16mm = +8mm, -8mm)

Floors
 Alum/elastomeric
 Recessed mount
 Standard load rating



Migutec FGH2 65/30

Joint sizes:
13/16" – 2" (20 - 50mm)
Movement:
 3/4" = + 3/8", -3/8"
 (20mm = +10mm, -10mm)

Floors
 Alum/rubber
 Recessed mount
 Standard load rating



Migutrans SFS 90/115/135

Joint sizes:
3/8" – 4" (10 - 100mm)
Movement:
 SFS 90 3/4" = + 3/8", -3/8"
 (20mm = +10mm, -10mm)
 SFS 115 1 1/8" = + 9/16", -9/16"
 (30mm = +15mm, -15mm)
 SFS 135 1 1/2" = + 3/4", -3/4"
 (40mm = +20mm, -20mm)

Floors
 Solid Aluminum
 Recess mount
 Heavy load rating

Sika Emseal offers an extended range of products. For more detailed information and drawings on any products please visit www.emseal.com. For additional products and sizes please contact Sika Emseal directly.

Standard CAD/BIM details are available online at www.emseal.com. For application specific CAD details contact Sika Emseal directly.



A SIKA COMPANY



Migutec KF 250 / KFE 251

Joint sizes:
1/2" – 3 1/4" (13 - 80mm)

Walls / Ceilings
Solid Aluminum
Surface mount



Twinsert Series

Joint sizes:
Up to 24" (825mm)
Movement:
Various

Floors
Solid Aluminum
Extra Heavy loading



SJS-System

Joint sizes:
2" – 16" (50 - 400mm)

Floors
Integral cover-plate / Non-invasively anchored
Extra Heavy loading



SJS-FR System

Joint sizes:
2" – 10" (50 - 250mm)

Floors
1-hour or 2-hour UL/ULC fire-rated
Integral cover-plate / Non-invasively anchored
Extra Heavy loading



QuietJoint

Joint sizes:
1" – 6" (25 - 150mm)

Walls and Windows
Mass-loaded acoustic seal / Insulating
Fire-resistant / Sound Attenuating
Non-mechanical and non-metallic

Sika Emseal offers an extended range of products. For more detailed information and drawings on any products please visit www.emseal.com. For additional products and sizes please contact Sika Emseal directly.

Standard CAD/BIM details are available online at www.emseal.com. For application specific CAD details contact Sika Emseal directly.

EMSEAL JOINT SYSTEMS, LTD 25 Bridle Lane, Westborough, MA 01581 USA
EMSEAL, LLC 111 Royal Group Crescent, Woodbridge, ON L4H 1X9 Canada

PH: 508-836-0280 FX: 508-836-0281
PH: 416-740-2090 FX: 416-740-0233



A SIKA COMPANY



A SIKA COMPANY

THE EMSEAL CHECKLIST

BUILDING TRUST



Name _____ **Company** _____ **Date** _____

Phone _____ **Fax** _____ **Email** _____

Job Name _____ **Job Location (City & State)** _____

INSTALLATION LOCATION

<input type="checkbox"/> Interior <input type="checkbox"/> Exterior	<input type="checkbox"/> Wall <input type="checkbox"/> Floor/Deck <input type="checkbox"/> Roof	<input type="checkbox"/> Above Grade <input type="checkbox"/> Below Grade <input type="checkbox"/> Submerged
--	---	--

CONSTRUCTION TYPE

New Construction
 Retrofit Construction

FIRE RATING

No Fire Rating
Fire Rating: 1-hr 2-hr 3-hr

EXPANSION GAP INFORMATION

Joint Gap Width(s): _____ Varies from: _____ to _____ (over its length)	Joint Substrate Depth: _____	Total Footage (ft or m): _____
Have Gap Dimensions Been Field Measured? <input type="checkbox"/> Yes / <input type="checkbox"/> No Substrate Surface Temp. _____ Ambient Temp. _____	Substrate Composition: _____ (e.g., concrete, brick, metal, etc.) Membrane Tie-in? <input type="checkbox"/> Yes / <input type="checkbox"/> No Type _____ Metal Pour Stops? <input type="checkbox"/> Yes / <input type="checkbox"/> No	
Movement (if known): _____ (e.g., ± thermal; ± shear, etc.)	Joint is: <input type="checkbox"/> Primary Seal <input type="checkbox"/> Secondary Seal	Joint Will Seal Out: <input type="checkbox"/> Rain/Water <input type="checkbox"/> Cold/Heat <input type="checkbox"/> Sound <input type="checkbox"/> Air <input type="checkbox"/> Vermin <input type="checkbox"/> Other _____
Are There Transitions? <input type="checkbox"/> Yes (explain) / <input type="checkbox"/> No	How Does the Joint Terminate?	

FOR HORIZONTAL DECK/FLOOR and ROOF JOINTS (ONLY)

DECK CONSTRUCTION

Is this a Solid Slab Condition? 
 Yes / No

Is this a Split Slab Condition? 
 Yes / No
Topping slab thickness: _____

Does the Joint have Blockouts? 
 Yes / No

Traffic Types (check all that apply):
 Car Bus Pedestrian None
Other _____

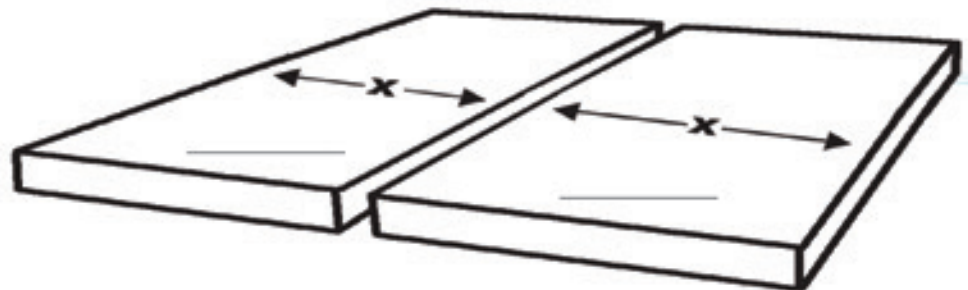

Please fill in the slab width dimensions at each "X". If one substrate of your joint is a wall instead of a slab, please denote that "X" as "Wall" instead of giving a dimension. If more than one joint occurs within the same immediate area, please draw them and the appropriate dimensions. Attach additional drawings as needed.

Please include any relevant details when submitting checklist to Sika Emseal

Architect: _____ **Engineer:** _____ **Contractor:** _____ **Owner/Developer:** _____



NOTES





A SIKA COMPANY

EMSEAL JOINT SYSTEMS, LTD

25 Bridle Lane
Westborough, MA 01581 USA
Tel. 508-836-0280 / Fax: 508-836-0281

EMSEAL, LLC

111 Royal Group Crescent
Woodbridge, Ontario L4H 1X9 Canada
Tel. 416-740-2090 / Fax: 416-740-0233

*For up-to-date CAD and BIM Details, Guide Specifications, Product Data, Install Data,
Technical Bulletins, Product Photos, Installation Portfolios and Videos, and more please visit:*

www.emseal.com