

WILLBRANDT Gummitechnik A/S



Railway technology
Winter services
Marine industry
Defense & Navy industry
Wind industry

Vibration technology
Compensators, expansion & flexible joints
Shock dampers
Hoses
Fender & fender systems
Profiles, moulded parts in rubber, silicone & polyurethane
Power transmission elements
Noise protection systems





Profile, history and figures

WILLBRANDT Gummitechnik has consistently specialized in elastomer technology products and enjoys an excellent reputation among customers as a competent problem solver, offering high-quality products.

Key figures

- 100 % owned by WILLBRANDT KG in Hamburg, which was founded in 1892
- WILLBRANDT Gummitechnik A/S was founded in 1994
- The company is privately owned by Mr. Per-Olof Arndt and Mr. Rainer Sattelmacher
- 15 highly qualified and motivated employees (group total: 135)
- Group turnover: € 50 million
- Certified according to ISO 9001 and 14001 as well as product and branch specific standards e.g. TransQ and Sellihca

We offer

- Tailormade and innovative solutions, involving all our product teams in DK and DE
- Partnership within stock keeping and logistics
- Production, product development, wholesale and engineering consulting services
- Worldwide activities with a strong local foundation
- High product quality based on our production know-how and quality assurance
- An experienced team of engineers and technicians, to back-up our customers, and sales teams
- Own production, along with representation of and stocking of well-known brands as GMT Gummi-Metall-Technik, Trelleborg Marine systems and Continental Contitech brands SchwingMetal® and MEGI®



Johnny Anekjær:
"We consider ourselves a strong and innovative partner representing high quality, reliability and flexibility"



Haslev, Copenhagen



Owner and departments in Germany



Per-Olof Arndt,
owner of
WILLBRANDT KG
and chairman of the
board in Denmark



Hamburg



Hanover



Berlin

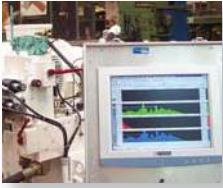

Engineering services & design

Our team of engineers are competent sparring partner, when it comes to vibration and shock damping. Our team knows how to combine elastomers with various products, in the WILLBRANDT product program providing an optimum solution with regards to quality, lifetime and price, ensuring easy installation and maintenance.

Based on a given assignment, we find the right solution within our product range. Alternatively customer specific solutions are designed. Development of customer specific products, has during the years lead to a number of patents and new product lines.

We offer

- Expert know-how within shock- and vibration damping and noise reduction (marine)
- Full technical calculations and design of e.g. pump unit-, production machinery- and motor suspensions
- Issue of full documentation packages
- Measurement of vibrations, structure- and airborne noise on site
- Own test facilities and close co-operation with universities and test institutes
- Development and production of customer specific active vibration dampers e.g. Mass dampers (Tilger)
- Calculation and production of fender systems for harbours and ships
- Calculation and production of drive belts and transmission systems
- Customized product modifications.

Calculation options and programs

- ShockDesign® shock calculation program
- Design program for SYLOMER® elastic bearings
- Spring characteristic calculations
- FEM calculations
- Drive calculations
- Design program for fenders
- 2D or 3D drawings

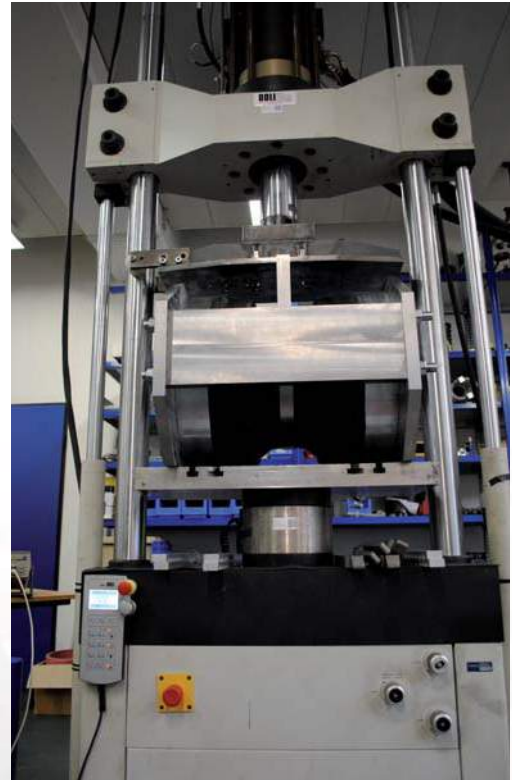

Horizontal stress test of SES 6000 shock damper

Vibration measurements on site



Engineering, test & calculations

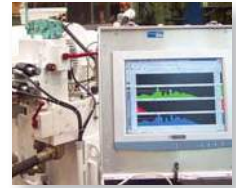

Vibration table available for test



Test in our own test room

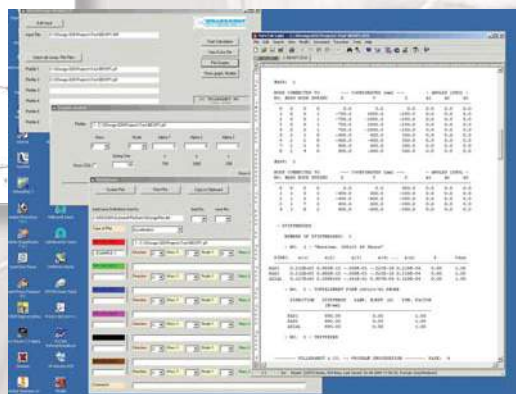
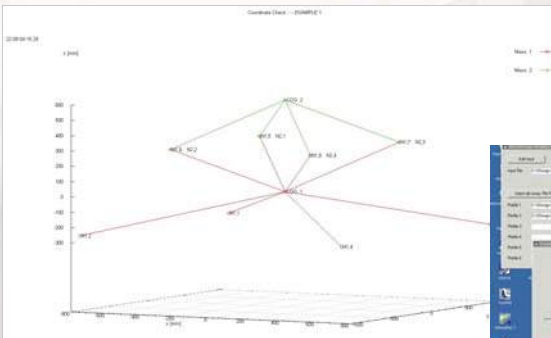



Service & logistic

A brochure and/or detailed catalogue is available for our various product areas. These can be downloaded from our webpage www.willbrandt.dk, or requested as a hard copy via our webpage. The catalogues offer applications, dimensions, technical drawings, assembling instructions and other data as well as calculation examples. These are all recognized by specialists to be indispensable when working with our products.

Every product area has its own specialists, who are at your service both technically and commercially. Our sales engineers are centrally located in Denmark and Sweden, to be easily accesable at your premises. When required, our engineers can assist with on-site consultancy, calculations, reports and documentation.

WILLBRANDT has a wide range of products stored in facilities in Haslev, Hamburg and Hanover. This combined with a flexible production, ensures a swift and reliable delivery.

Individual customer requirements for service, modifications, fitting and assembling, are met with precision and craftsmanship, no matter the size. For selected product ranges, we offer E-commerce and EDI solutions.



Large range
in stock





Service



Engineering-, drawing-, test- and development facilities



Flexible production possibilities

德国官方参展代表
Germany



Worldwide fair activities e.g. InnoTrans, SMM and Marinetec Shanghai

VOFLEX
Teil-Federelemente
Isolators

WIND ENERGY

Profiles and Moulded Parts

WILLBRANDT GUMMITECHNIK
Hamburg Hannover Berlin Düsseldorf



Railway technology

WILLBRANDT Gummitechnik A/S has for decades, been a well-known supplier to Danish railway. Today we supply parts and components to all the major actors in Denmark, Norway, Sweden and Finland. Our internal- and external product managers are well aware of the special needs, for the various train sets.

WILLBRANDT Gummitechnik A/S is participating at InnoTrans and NordicRail. Here we show parts and components for the bogie and the car body. WILLBRANDT Gummitechnik A/S is certified to ISO 9001 and approved to TransQ.

Our main supplier of rubber components, for the train bogie, is GMT Gummi-Metall-Technik with head quarter in Bühl, Germany. GMT is certified according to IRIS, ISO 9001 and 14001. This stands for high quality with a large development knowledge. GMT is supplying the complex primary- and secondary suspension to the major OEMs, such as Siemens, Bombardier, Alstom, Skoda and Stadler.

In co-operation with our partners and through an extensive development program, we have a wide product range enabling us to supply most of the products available in the market e.g. Air springs from Toyo, Contitech and Phoenix.

Many of the products are on stock in Denmark for a swift delivery, enabling our customers to reduce their inventory.



Axle guiding bush for housing (Görlitz 8 DD)



Turbo- and cooling hoses with clamps for MTU power pack.



Railway technology



Frame support with rubber on top of steel spring.

Other rubber parts supplied by WILLBRANDT Gummitechnik A/S:

- Cooling- and turbo hoses with clamps
- Suspensions for the power pack frame and components
- Drive- and power belts
- Rubber profiles- and seals for internal- and external use.
- Cell- and foam rubber for boxes
- Various buffers and suspensions for boxes and panels
- Snow covers and bellow seals
- Bellows for traction and protection
- Rubber- and steel compensators

We strive to be your "one stop" supplier of all rubber- and vibration components, minimizing your time used when purchasing.

WILLBRANDT also offers to enter long term agreements as stock keeper, to secure a swift and precise delivery.

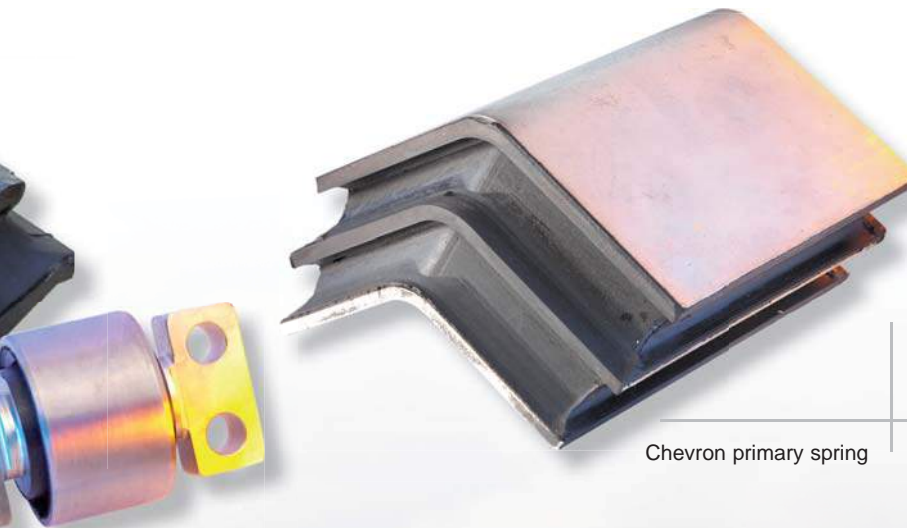

Chevron primary spring



Moulded rubber bellow

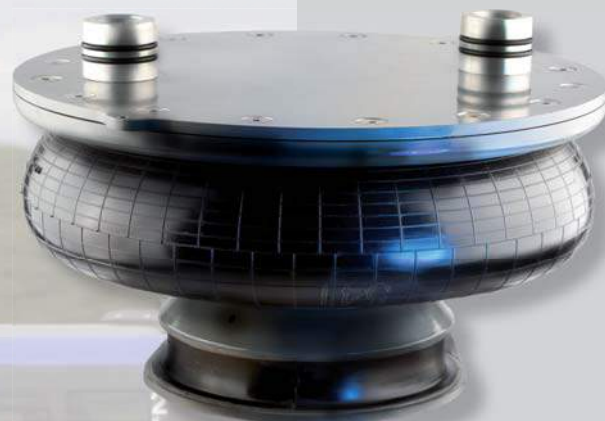



Winter services & spare parts for airports & road services

For decades WILLBRANDT has been well known as a reliable supplier of wear parts and we are always ready when winter sets in.

To ensure a swift delivery, all common sizes in rubber, polyurethane and steel, are on stock at our facilities in Haslev south of Copenhagen, ensuring a fast delivery to all ploughs.

Various other parts are also on stock e.g.

- Spreader disc and bushing for NIDO salt spreader units
- Various steel cutting edges and edges with carbide insert
- Bolts and nuts
- Buffers and dampers in rubber and polyurethane
- Sliding pads in polyurethane
- Polyurethane cutting edges for various ploughs
- Various suspensions

A high level of expertise has been built throughout the years, including a high number of tools and a catalogue with drawings for the most common snow ploughs. We can help you decide on the type of material and hardness. At our work-shop we can cut and drill, preparing the products for mounting.

A special area is airports where we have developed a special compound, this gives a life span up to 40 % longer compared to other polyurethane scraper blades. These blades are on stock in Haslev.



PUR-blade for snowplough



Wheel chock in polyurethane



Salt spreader disc



Various dimensions and lengths on stock



Scraper in polyurethane for EP9

Marine and shipyard industry



EM3 engine suspension

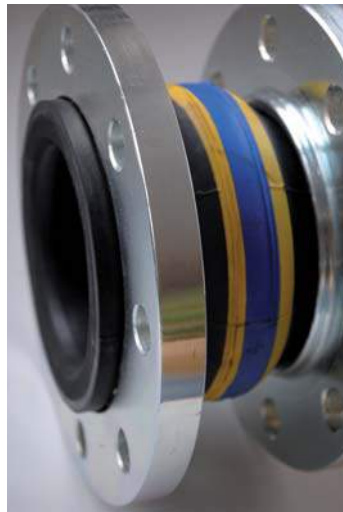

Rubber expansion joint, type 50 yellow blue



Exhaust pipe suspension



Suspensions for motors, fans, pumps and machines

The maritime world is closely connected to the history of WILLBRANDT. The company started with servicing the harbour and ship yards in Hamburg. This gives us the knowledge and experience to understand the needs and requirements of this industry.

Throughout time we have developed many special solutions for our customers, which has led to patented innovations. Chock dampers in rubber, and steel rope suspensions (called CAVOFLEX®) are synonymous with WILLBRANDT.

WILLBRANDT offer package solutions, ranging from development and engineering, to delivery of the final product. The majority of products are normally on stock or stocked according to agreement, ensuring a swift delivery year after year. This also helps keeping prices stable.

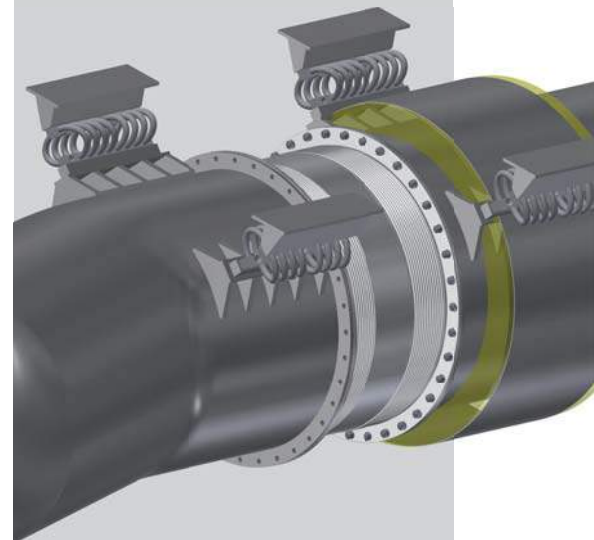



Defense and navy industry

WILLBRANDT is a well known supplier of elastic suspensions and moulded parts to the defense and navy industry.

We offer vibration- and chock suspensions which have been used successfully for extreme applications within the defense industry.

Whether it is profiles or gaskets for armored vehicles, seals for tanks, chock suspensions for radar systems, electrical switch boards, life rafts or canons onboard submarines or frigates, or fenders for the vessels, WILLBRANDT sets the standard with tailormade solutions, quality and documentation.



Test of SES 6000 shock damper

Antenna support with LageFix

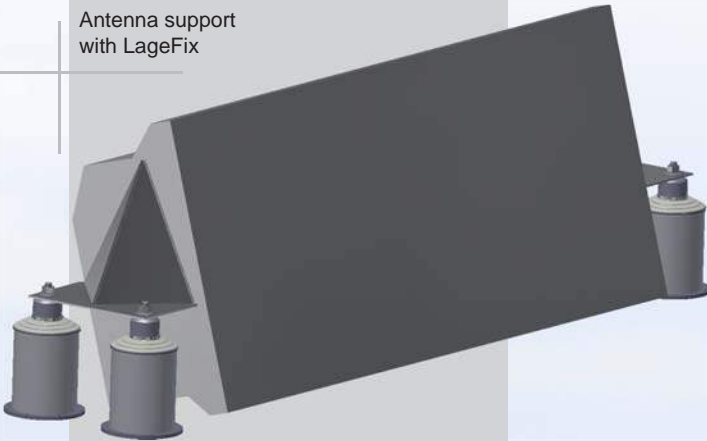

CAVOFLEX wire rope chock mounts

Rubber-metal chock mount

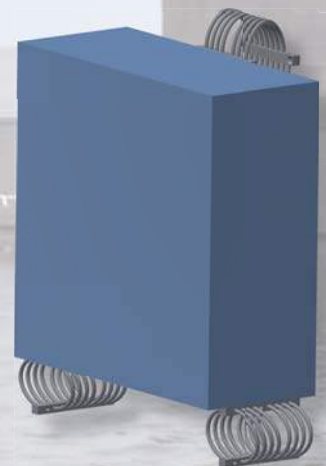



Wind industry

Rubber-to-metal gear damper

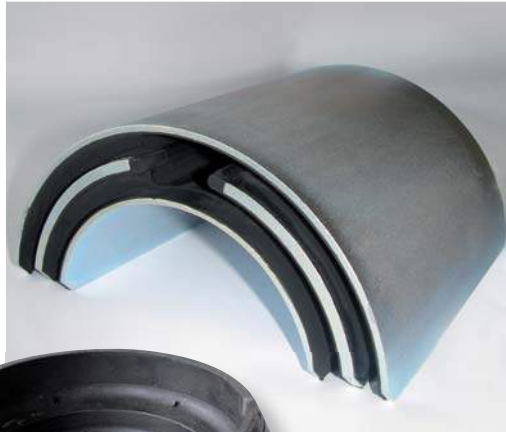

Cabel mount for wind turbine



Within the Wind power industry WILLBRANDT is known as a flexible and solution oriented partner, who think in new ways of doing things. We use our experience from other industries e.g. Marine and Military, when designing and producing components with high quality and a long life span.

We supply everything from standard sheet material to complex vibration mounts.

We cover various elastomers, including rubber and polyurethane, offering our customers a "One stop" solution. Our logistic solutions combined with large stock, ensures a swift delivery.

We offer

- Special gear- and generator mounts, adjustable in both horizontal and vertical direction
- Active damper solutions (Mass damper/ Tilger)
- Rubber- and sealing profiles
- Cable mounts and protection
- Special protection profiles for transport equipment



Support frames with polyurethane for transportation of blades on trucks or ships



Generator mount



Vibration & shock technology

Vibration technology is one of the keystones of WILLBRANDT and has been a big part of shaping WILLBRANDT.

WILLBRANDT KG in Hamburg has been the main representative of Continental Contitech's SCHWINGMETALL® program for more than 70 years. The product range MEGI® is marketed and sold by J. Meinert, a company in the WILLBRANDT group. Both SCHWINGMETALL® and MEGI® standard programs are on stock in Hamburg.

For the past decade GMT Gummi-Metall-Technik has become an important partner, as WILLBRANDT Gummitechnik A/S in Scandinavia is marketing GMTs high quality products for e.g. wind and railway industry. A large number of GMT products are on stock at WILLBRANDT Gummitechnik A/S in Denmark.

At WILLBRANDT we help clients deal with vibration and structure borne noise on a daily basis, using on the shelf products.

But custommade solutions are also developed for individual needs.

We offer

- Various GMT springs for rail applications such as: Lateral buffers, Air springs, Secondary support spring, Primary suspensions, Bellows and Primary interleaf spring
- SCHWINGMETALL® and MEGI® buffers, dampers, bushings, hydro mounts and rail mounts
- Special rubber-to-metal parts such as hydro- and flange mounts
- WILLBRANDT range of shock dampers in rubber-to-metal e.g. SES, LSG, DB, HFSE, Barry Controls and TR2
- Cavoflex® wire rope dampers type H, QX, RX and TX from WILLBRANDT
- GMT Tri-Flex vibration dampers for special applications and for marine applications with DNV certification
- Resilient mounts for pipe systems e.g. exhaust pipes onboard ships
- Double acting KSD® vibration dampers
- Vibration damping with Sylomer®

SCHWINGMETALL® and WILLBRANDT elBe dampers

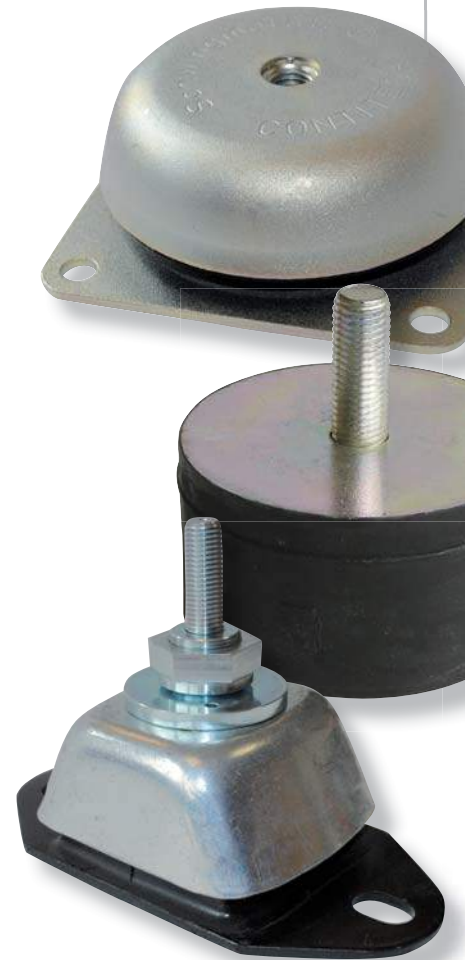

Rubber-to-metal type 2 cut to length

Sandwich construction secondary spring



Sandwich construction emergency spring



Vibration & shock technology



Double elastic vibration mount for industrial machine



CAVOFLEX® wire rope shock damper for special applications





Compensators & expansion joints

Expansion joints made of rubber, steel and fabric with inside lining, are used to cope with expansion, movement, noise or construction tolerances in pipe systems and ventilation channels.

Choice of type depends on the application and the working conditions e.g. pressure, temperature and media. Our engineers offer design and dimensioning to ensure the best solution. WILLBRANDT has a wide range of materials and sizes on stock, and manufacture customized versions as well.

Our customers include

- Shipyards
- Pharma-, medico and chemical industry
- Power plants and biogas
- Off-shore
- District heating, drinking water and sewage treatment
- Exhaust gas systems and air intake

In our main stock in Hamburg, we stock from size DN 20 - DN 1000, but we are able to deliver up till size DN 6000.



Large stock of bellows and flanges for all applications



PTFE-expansion joint for a special fluid

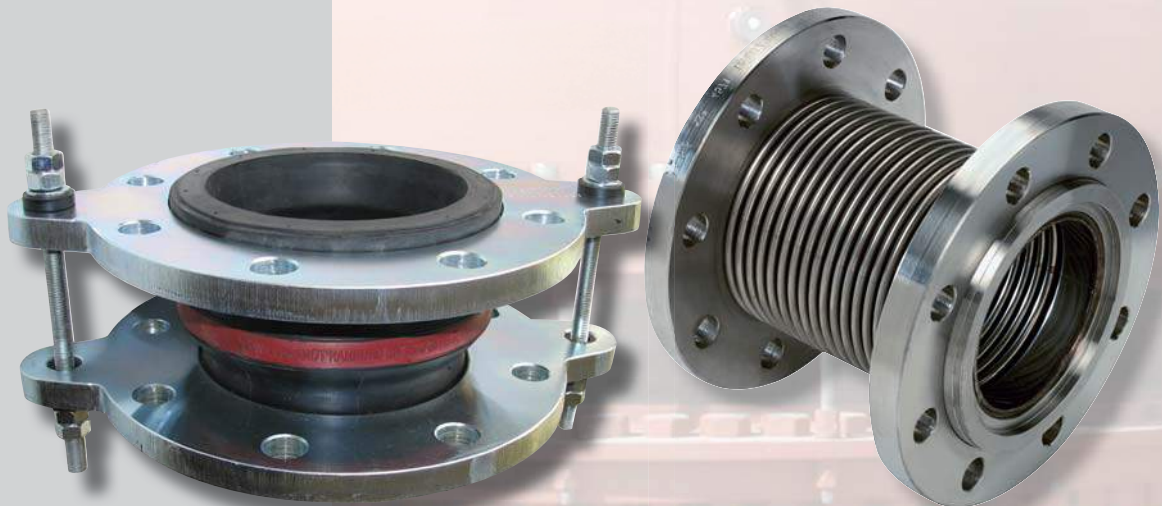

Compensators & expansion joints



Very big expansion joints with tie rods on a power plant

We offer

- Rubber and silicone expansion joints with steel or stainless steel flanges
- Stainless steel expansion joints
- Fabric expansion joints
- Optionally the expansion joints are offered with e.g. bolts, flame protective covers, vacuum support rings and tie rods

We also offer service, installation and control.

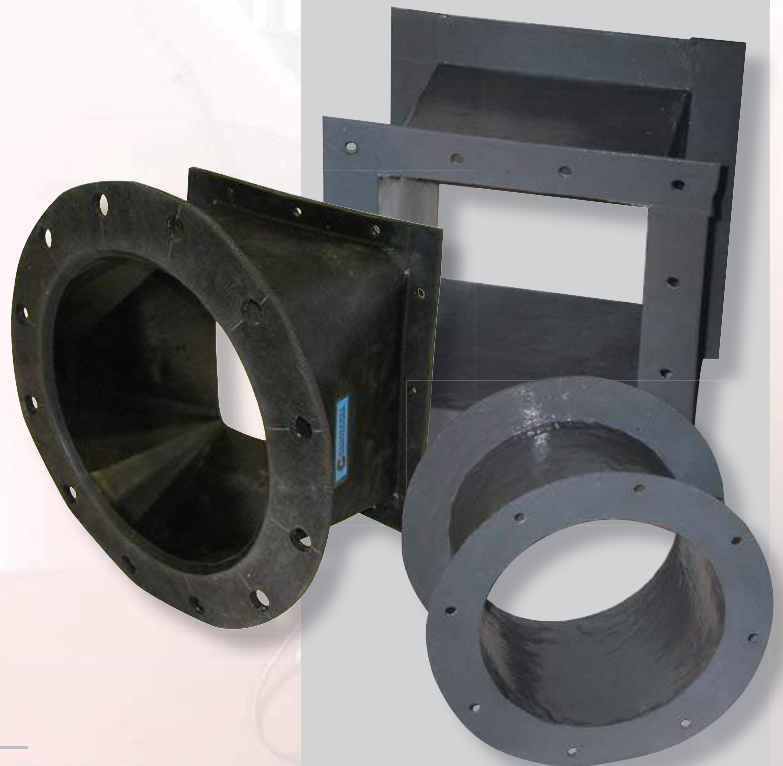



Fenders & fender systems for ship & harbour



Fender system to protect both sides of a canal bridge



PUR roller fender



Foam filled floating fender with steel construction, following the tide up and down



UV resistant navigation buoy with body of PU-foam



Individually manufactured fender strip of PE foam with PUR skin

Fenders & fender systems for ship & harbour



Fendersystem with rubber fender and sliding bars



System of cylindrical and floating-foam-fender



Fenderguiding with archfenders and steel construction with sliding bars of HD-PE



For decades, WILLBRANDT has been a renowned supplier of fenders and fender systems, and rubber profiles for marine and harbour applications throughout the world. Our products are designed and manufactured in compliance with EAU 2004 and PIANC 2002.

WILLBRANDT is the sole dealer of Trelleborg Marine Systems. Trelleborg is the worlds leading supplier of fenders and fender systems.

Our engineers, and sales specialists take over all aspects of planning, drawing, design, sale and assembling on site if required.

Our productline is completed by a diverse selection of fenders and accessories for marine applications.

Our range of products at a glance

- Cylindrical, square and D-shaped fenders
- Wheel and roller fenders
- Floating-foam-fenders and pneumatic fenders
- PUR fender systems
- Arch, cone and circle fenders
- Slide strips and plates of UHMW-PE and HD-PE
- Accessories for fender systems
- Lock gate seals
- Special seals (e.g. inflatable door seals)
- Profiles, rubbing strips and accessoires for sailing boats and motor yachts
- Magnetic hatch cover tapes
- Navigation buoys



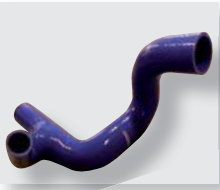

Profiles & moulded parts as well as hoses

WILLBRANDT develop and produce according to individual drawings and customer samples and specifications to provide the right product for every need. With the customer, we can determine the optimum quality for the respective application, from our large variety of elastomer and polymers.

For decades the company has been representing the hose programme of Continental Contitech including their renowned brands Contitech, Phoenix, Paguag and Blaudieck. These brands are known for high quality, safety and long life time, offering low maintenance costs.

We offer

- Edge protection profiles
- Clamping and filler profiles
- Corner vulcanized frames and rings
- Different shaped cords
- Moulded parts according to drawings
- Rubber-metal and rubber-fabric joints
- Bellows
- Moulded flex hoses in various materials
- Turbo and cooling hoses
- Crane pads
- Cable glands

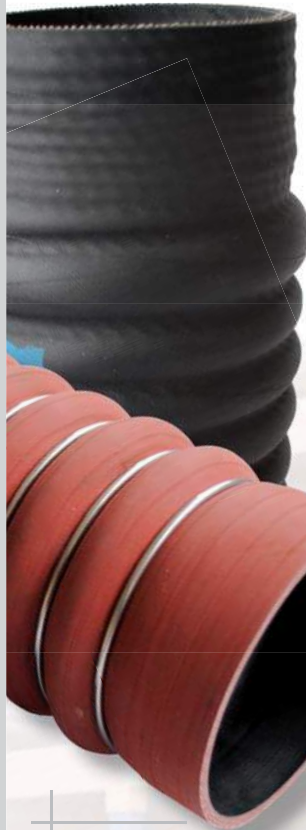

Paguag food grade hose with coupling



Cooling and turbo hose

Various profiles in rubber and silicone

Moulded silicone hose with two different diameters



Hose clamp



Polyurethane parts of various qualities



Special Sealings & gaskets



WILLBRANDT specialize in gaskets for gas and water pipes with all current approvals according to DIN-DVGW and DIN-DVGW-KTW. We also develop and produce seals for cleaning and sweeping machines.

A large number of our products are manufactured in our Hanover subsidiary for which we have extensive machinery and equipment (punches, plotters).

We stock a wide range of finished and semi-finished products which are constantly expanded.

Our range of products at a glance

- GASFALIT® gaskets for gas supply
- WILLBRALIT® gaskets for gas supply
- AQUALIT® gaskets for water supply
- WAGALIT® rubber-steel flange gaskets
- Flange gaskets
- EPDM rubber-steel flange gaskets
- Adjustable wedge-shaped gaskets
- Grooved gaskets
- Industrial gaskets
- Special gaskets in polyurethane with adhesive on the back side

Production of industrial seals on plotter from all elastomers, fibres, cork or paper



Wedge-shaped gasket for underground conduits



Production of industrial seals from all elastomers, fibres, cork or paper

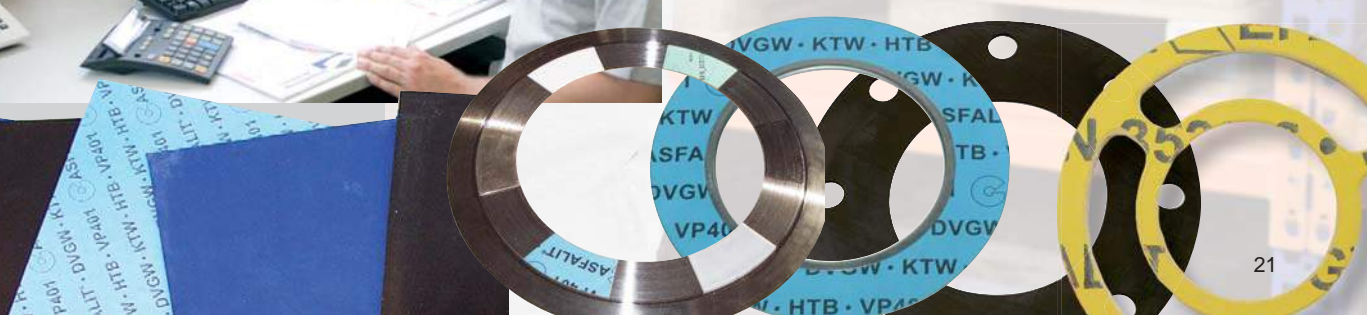



Power Transmission Elements

Our range of services at a glance

- Competent consulting on site
- Permanent stock of more than 600 drive belt sizes
- Close co-operation with ContiTech
- Computer-aided single and multiple drive shaft calculations
- Full range of joints and joint rod ends
- Fast and reliable delivery

Our range of products at a glance

- Drive belts (e.g. V-belts, timing belts, V-ribbed belts)
- Drive pulleys
- ROTAFRIX® friction rings and wheels
- Special wheels
- Ball joints and fork ends
- PAGUFLEX® couplings
- Rod ends
- Spherical plain bearings
- Remote controls
- OneStep clamping sets



ContiTech drive belts
- V-belts
- V-ribbed belts
- Timing belts
- Flat belts



Couplings



Friction rings

Ball joints and fork ends according to DIN



Rod ends



Noise Protection Systems



Acoustic ceiling



Acoustic pictures



Acoustic wall

At WILLBRANDT, noise protection begins with consulting. Statutory requirements (DIN EN and VDI directives, requirements of "TA Lärm" (technical instruction on noise protection), "UVV Lärm" (noise accident prevention regulation) and work-places ordinance) are taken into account, this ensures the functionality, specified by the customer.

The customer concept is prepared, and an analysis of the situation is done locally, on the spot.

WILLBRANDT offers a choice between standard elements and customer tailored element production. Assembling and final sound measurements are done by our specialists.

Our range of products at a glance

- Sound protecting cabins and enclosures
- Noise barriers
- Room acoustics from pinta acoustic
- Acoustic foams
- Sound insulating panels
- Sound absorbers
- Anechoic measuring rooms
- Sound absorber barriers
- Acoustic curtains
- SYLOMER® elastic bearings

Plant bedding on SYLOMER®



Soundproof test room made with Contrabel

CAVOFLEX®

Drahtseil-Federelemente
Wire Rope Isolators



Fender für Schiff und Hafen

Fenders for Ship and Harbour



Schockdämpfer Shock absorbers



Products for airport services

Snowplough blades and spare parts for snow cleaning vehicles wheel chocks



Bahntechnik Railway Technology



WILLBRANDT The Compensator Catalogue

Product Description
Technical Data
Advice on Application
Calculation Criteria



WILLBRANDT GUMMITECHNIK elBe

Flexiblen optag til blandt andet motorer og maskiner
Flexibla motor- och maskinfästen

Udførelser:
Færdiglavt / udførelses (M)
eller 400 færdig lavet i rustfrit stål / rustfremmet (M)

for en til anvendelsen af motorer og maskiner, som kræver høj præcision og stabilitet.

Produktet er lavet af høj kvalitet gummi og er derfor meget holdbart og har en lang levetid.

Produktet er lavet af høj kvalitet gummi og er derfor meget holdbart og har en lang levetid.

Produktet er lavet af høj kvalitet gummi og er derfor meget holdbart og har en lang levetid.

Produktet er lavet af høj kvalitet gummi og er derfor meget holdbart og har en lang levetid.

Produktet er lavet af høj kvalitet gummi og er derfor meget holdbart og har en lang levetid.

Produktet er lavet af høj kvalitet gummi og er derfor meget holdbart og har en lang levetid.

Produktet er lavet af høj kvalitet gummi og er derfor meget holdbart og har en lang levetid.

Produktet er lavet af høj kvalitet gummi og er derfor meget holdbart og har en lang levetid.

Produktet er lavet af høj kvalitet gummi og er derfor meget holdbart og har en lang levetid.

Produktet er lavet af høj kvalitet gummi og er derfor meget holdbart og har en lang levetid.

Produktet er lavet af høj kvalitet gummi og er derfor meget holdbart og har en lang levetid.

Produktet er lavet af høj kvalitet gummi og er derfor meget holdbart og har en lang levetid.

Produktet er lavet af høj kvalitet gummi og er derfor meget holdbart og har en lang levetid.

Produktet er lavet af høj kvalitet gummi og er derfor meget holdbart og har en lang levetid.

Produktet er lavet af høj kvalitet gummi og er derfor meget holdbart og har en lang levetid.

Produktet er lavet af høj kvalitet gummi og er derfor meget holdbart og har en lang levetid.

Produktet er lavet af høj kvalitet gummi og er derfor meget holdbart og har en lang levetid.

Produktet er lavet af høj kvalitet gummi og er derfor meget holdbart og har en lang levetid.

Produktet er lavet af høj kvalitet gummi og er derfor meget holdbart og har en lang levetid.

Produktet er lavet af høj kvalitet gummi og er derfor meget holdbart og har en lang levetid.

Produktet er lavet af høj kvalitet gummi og er derfor meget holdbart og har en lang levetid.

Produktet er lavet af høj kvalitet gummi og er derfor meget holdbart og har en lang levetid.

Produktet er lavet af høj kvalitet gummi og er derfor meget holdbart og har en lang levetid.

Produktet er lavet af høj kvalitet gummi og er derfor meget holdbart og har en lang levetid.

Produktet er lavet af høj kvalitet gummi og er derfor meget holdbart og har en lang levetid.

Produktet er lavet af høj kvalitet gummi og er derfor meget holdbart og har en lang levetid.

Produktet er lavet af høj kvalitet gummi og er derfor meget holdbart og har en lang levetid.

Produktet er lavet af høj kvalitet gummi og er derfor meget holdbart og har en lang levetid.

Produktet er lavet af høj kvalitet gummi og er derfor meget holdbart og har en lang levetid.

Produktet er lavet af høj kvalitet gummi og er derfor meget holdbart og har en lang levetid.

Produktet er lavet af høj kvalitet gummi og er derfor meget holdbart og har en lang levetid.

Produktet er lavet af høj kvalitet gummi og er derfor meget holdbart og har en lang levetid.

Produktet er lavet af høj kvalitet gummi og er derfor meget holdbart og har en lang levetid.

Produktet er lavet af høj kvalitet gummi og er derfor meget holdbart og har en lang levetid.

Produktet er lavet af høj kvalitet gummi og er derfor meget holdbart og har en lang levetid.

Produktet er lavet af høj kvalitet gummi og er derfor meget holdbart og har en lang levetid.

Produktet er lavet af høj kvalitet gummi og er derfor meget holdbart og har en lang levetid.

Produktet er lavet af høj kvalitet gummi og er derfor meget holdbart og har en lang levetid.

Produktet er lavet af høj kvalitet gummi og er derfor meget holdbart og har en lang levetid.

Produktet er lavet af høj kvalitet gummi og er derfor meget holdbart og har en lang levetid.

Produktet er lavet af høj kvalitet gummi og er derfor meget holdbart og har en lang levetid.

Produktet er lavet af høj kvalitet gummi og er derfor meget holdbart og har en lang levetid.

Produktet er lavet af høj kvalitet gummi og er derfor meget holdbart og har en lang levetid.

Produktet er lavet af høj kvalitet gummi og er derfor meget holdbart og har en lang levetid.

Produktet er lavet af høj kvalitet gummi og er derfor meget holdbart og har en lang levetid.

Produktet er lavet af høj kvalitet gummi og er derfor meget holdbart og har en lang levetid.

Produktet er lavet af høj kvalitet gummi og er derfor meget holdbart og har en lang levetid.

Produktet er lavet af høj kvalitet gummi og er derfor meget holdbart og har en lang levetid.

Produktet er lavet af høj kvalitet gummi og er derfor meget holdbart og har en lang levetid.

Produktet er lavet af høj kvalitet gummi og er derfor meget holdbart og har en lang levetid.

Produktet er lavet af høj kvalitet gummi og er derfor meget holdbart og har en lang levetid.

Produktet er lavet af høj kvalitet gummi og er derfor meget holdbart og har en lang levetid.

Produktet er lavet af høj kvalitet gummi og er derfor meget holdbart og har en lang levetid.

Produktet er lavet af høj kvalitet gummi og er derfor meget holdbart og har en lang levetid.

Produktet er lavet af høj kvalitet gummi og er derfor meget holdbart og har en lang levetid.

Produktet er lavet af høj kvalitet gummi og er derfor meget holdbart og har en lang levetid.

Produktet er lavet af høj kvalitet gummi og er derfor meget holdbart og har en lang levetid.

Produktet er lavet af høj kvalitet gummi og er derfor meget holdbart og har en lang levetid.

Produktet er lavet af høj kvalitet gummi og er derfor meget holdbart og har en lang levetid.

Produktet er lavet af høj kvalitet gummi og er derfor meget holdbart og har en lang levetid.

Produktet er lavet af høj kvalitet gummi og er derfor meget holdbart og har en lang levetid.

Produktet er lavet af høj kvalitet gummi og er derfor meget holdbart og har en lang levetid.

Produktet er lavet af høj kvalitet gummi og er derfor meget holdbart og har en lang levetid.

Produktet er lavet af høj kvalitet gummi og er derfor meget holdbart og har en lang levetid.

Produktet er lavet af høj kvalitet gummi og er derfor meget holdbart og har en lang levetid.

Produktet er lavet af høj kvalitet gummi og er derfor meget holdbart og har en lang levetid.

Produktet er lavet af høj kvalitet gummi og er derfor meget holdbart og har en lang levetid.

Produktet er lavet af høj kvalitet gummi og er derfor meget holdbart og har en lang levetid.

Produktet er lavet af høj kvalitet gummi og er derfor meget holdbart og har en lang levetid.

Produktet er lavet af høj kvalitet gummi og er derfor meget holdbart og har en lang levetid.

Produktet er lavet af høj kvalitet gummi og er derfor meget holdbart og har en lang levetid.

Produktet er lavet af høj kvalitet gummi og er derfor meget holdbart og har en lang levetid.

Produktet er lavet af høj kvalitet gummi og er derfor meget holdbart og har en lang levetid.

Produktet er lavet af høj kvalitet gummi og er derfor meget holdbart og har en lang levetid.

Produktet er lavet af høj kvalitet gummi og er derfor meget holdbart og har en lang levetid.

Produktet er lavet af høj kvalitet gummi og er derfor meget holdbart og har en lang levetid.

Produktet er lavet af høj kvalitet gummi og er derfor meget holdbart og har en lang levetid.

Produktet er lavet af høj kvalitet gummi og er derfor meget holdbart og har en lang levetid.

Produktet er lavet af høj kvalitet gummi og er derfor meget holdbart og har en lang levetid.

Produktet er lavet af høj kvalitet gummi og er derfor meget holdbart og har en lang levetid.

Produktet er lavet af høj kvalitet gummi og er derfor meget holdbart og har en lang levetid.

Produktet er lavet af høj kvalitet gummi og er derfor meget holdbart og har en lang levetid.

Produktet er lavet af høj kvalitet gummi og er derfor meget holdbart og har en lang levetid.

Produktet er lavet af høj kvalitet gummi og er derfor meget holdbart og har en lang levetid.

Produktet er lavet af høj kvalitet gummi og er derfor meget holdbart og har en lang levetid.

WILLBRANDT Svingningsdæmpere

Gummi- og metal-tilkoblinger til lys, dæk og svingnings-isolering



GMT PRODUKTINFORMATION

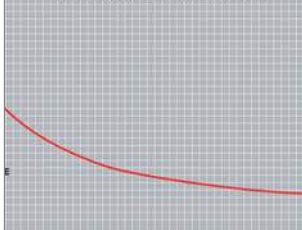

WILLBRANDT GUMMITECHNIK

WILLBRANDT Gummitechnik A/S
Finlandsgade 29
4690 Haslev
Denmark
Phone +45 56870164
Fax +45 56872208
eMail info@willbrandt.dk

ISO 9001
BUREAU VERITAS
Certification



WILLBRANDT KG
Schnackenburgallee 180
22525 Hamburg
Germany
Phone +49 40 540093-0
Fax +49 40 540093-47
eMail info@willbrandt.de
web www.willbrandt.de

Subsidiary Hannover
Reinhold-Schleese-Straße 22
30179 Hanover
Germany
Phone +49 511 99046-0
Fax +49 511 99046-30
eMail hannover@willbrandt.de

Subsidiary Berlin
Breitenbachstraße 7 - 9
13509 Berlin
Germany
Phone +49 30 435502-25
Fax +49 30 435502-20
eMail berlin@willbrandt.de

www.willbrandt.dk
www.willbrandt.se