

IEC 63...90L, 4 poles  
 Δ/Y 230/400V/50Hz  
 I.C.I.F - IP69K - IC410  
 Efficiency IE3 (IEC60034-30, IEC60034-2-1 Pn ≥ 0,75kW)  
 Duty S1  
 Degree of protection IP69K  
 INVERTER DUTY; HYGIENIC  
 PTO PROTECTION INCLUDED

**IEC  
B14**

**Clean-Geartech products**

Riduttori Clean-Geartech

**Stainless steel worm gearboxes**

Riduttori a vite senza fine in acciaio inox

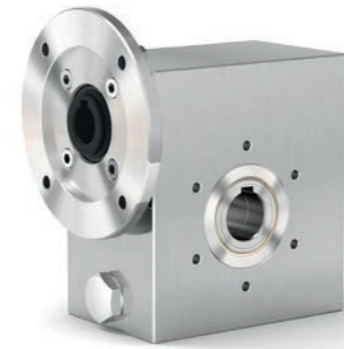

**130 21 Nm**  
**145 41 Nm**  
**150 72 Nm**  
**163 147 Nm**  
**185 347 Nm**  
**111 651 Nm**

**Stainless steel ratio multiplier**

Riduttore ad uno stadio in acciaio inox

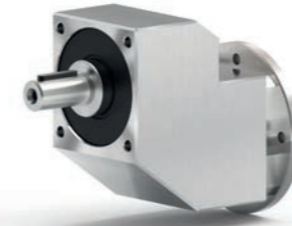

**4111 38 Nm**

**Stainless steel helical bevel gearboxes**

Riduttori a coppia conica in acciaio inox

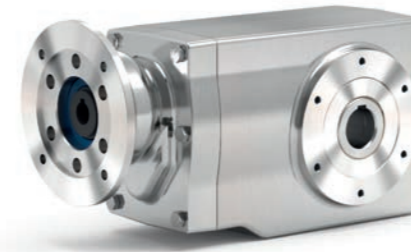

**X421 150 Nm**  
**X621 410 Nm**

**Aluminum worm gearboxes with NTT™ treatment**

Riduttori a vite senza fine in alluminio con trattamento NTT™



**Z30 21 Nm**  
**Z45 41 Nm**  
**Z50 72 Nm**  
**Z63 147 Nm**  
**Z85 347 Nm**

**CLEAN-GEARTECH**

e-mail: info@cleangeartech.com web: www.cleangeartech.com



DP - S5 MM - C G T 0 1 8 - ML



**CLEAN-GEARTECH**

**Stainless steel and aluminum Motors**

Motori in acciaio inox ed in alluminio

Totally Enclosed Non Ventilated - Totalmente chiusi, non ventilati

Totally clean smooth surface - Superfici pulite

Ideal for food and pharmaceutical use - Ideali per industria alimentare e farmaceutica



IE3

IP69K

AISI  
316L



IE3

IP69K

SPM - Stainless steel Premium Motors

APM - Aluminum Premium Motors

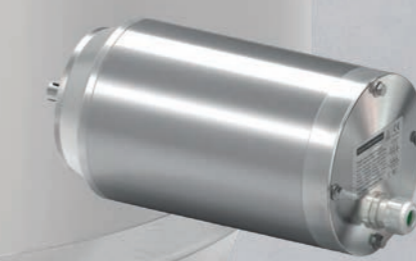

**IEC  
B5  
on request**

**Premium electric motors**

Motori elettrici

**SPM motors dimensions**

Dimensioni motori SPM

**B5**

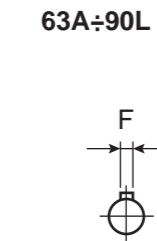

**63A=90L**

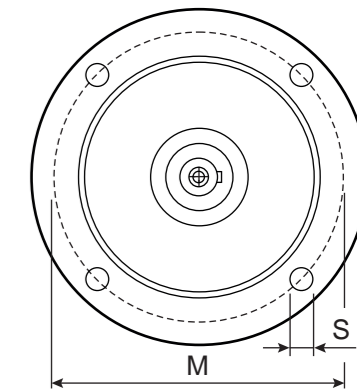
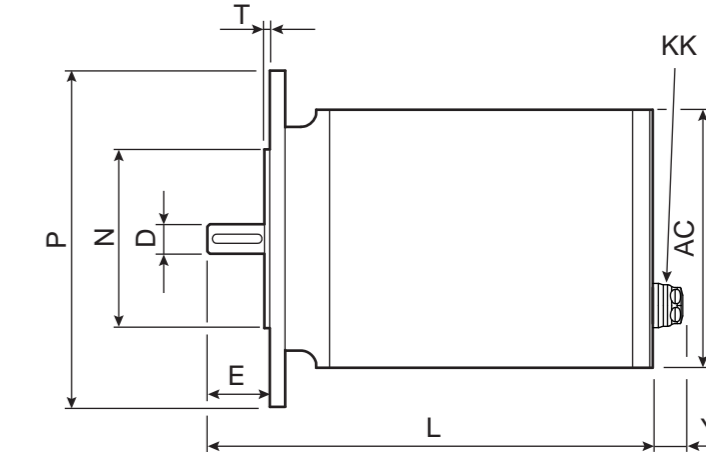

**100LA**

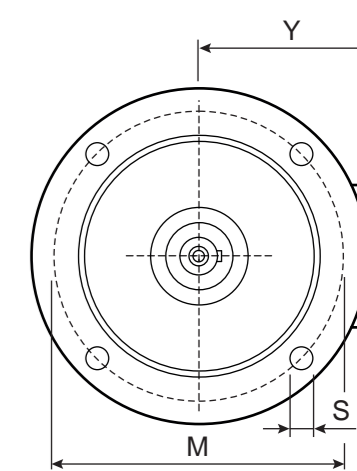
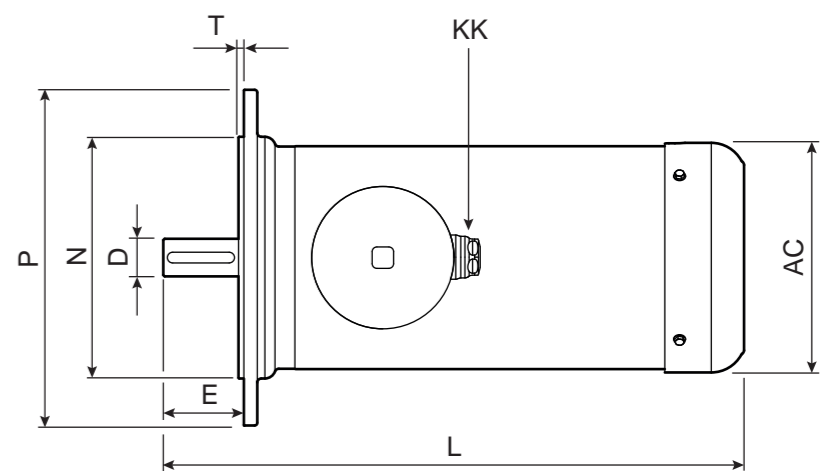
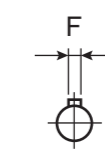

4 poles B5

Motor	kW	IE3	rpm (min <sup>-1</sup> )	Nm	A (400V)	COS (φ)	D	F	E	L	AC	Y	N	M	P	T	S	KK	Kg
<b>63A*</b>	0.12		1440	0.80	0.44	0.57	11 j6 M4	4	23	229	131	24	95 j6	115	140	3	4x10	M16x1.5 ø7.5-10	9.4
<b>63B*</b>	0.18		1440	1.19	0.58	0.62	11 j6 M4	4	23	244	131	24	95 j6	115	140	3	4x10	M16x1.5 ø7.5-10	10.7
<b>71A*</b>	0.25		1440	1.66	0.72	0.64	14 j6 M5	5	30	266	131	27	110 j6	130	160	3.5	4x10	M20x1.5 ø11-13.5	12.5
<b>71B*</b>	0.37		1440	2.45	1.10	0.64	14 j6 M5	5	30	286	131	27	110 j6	130	160	3.5	4x10	M20x1.5 ø11-13.5	14.4
<b>80A*</b>	0.55		1460	3.60	1.50	0.67	19 j6 M6	6	40	280	166	27	130 j6	165	200	3.5	4x12	M20x1.5 ø11-13.5	21.0
<b>80B*</b>	0.75		1460	4.91	2.10	0.67	19 j6 M6	6	40	305	166	27	130 j6	165	200	3.5	4x12	M20x1.5 ø11-13.5	24.0
<b>90S*</b>	1.1		1460	7.20	2.90	0.70	24 j6 M8	8	50	345	166	30	130 j6	165	200	3.5	4x12	M25x1.5 ø15-18	28.5
<b>90L*</b>	1.5		1460	9.81	4.00	0.70	24 j6 M8	8	50	390	166	30	130 j6	165	200	3.5	4x12	M25x1.5 ø15-18	34.5
<b>100LA*</b>	2.2		1440	14.6	4.80	0.79	28 j6 M10	8	60	432.5	171	140	180 j6	215	250	4	4x15	M20x1.5 ø11-13.5	36.0

\* APM Series not available  
 \* Serie APM non disponibile

**APM and SPM motors dimensions**

Dimensioni motori APM ed SPM

**B14**

**63A=90L**

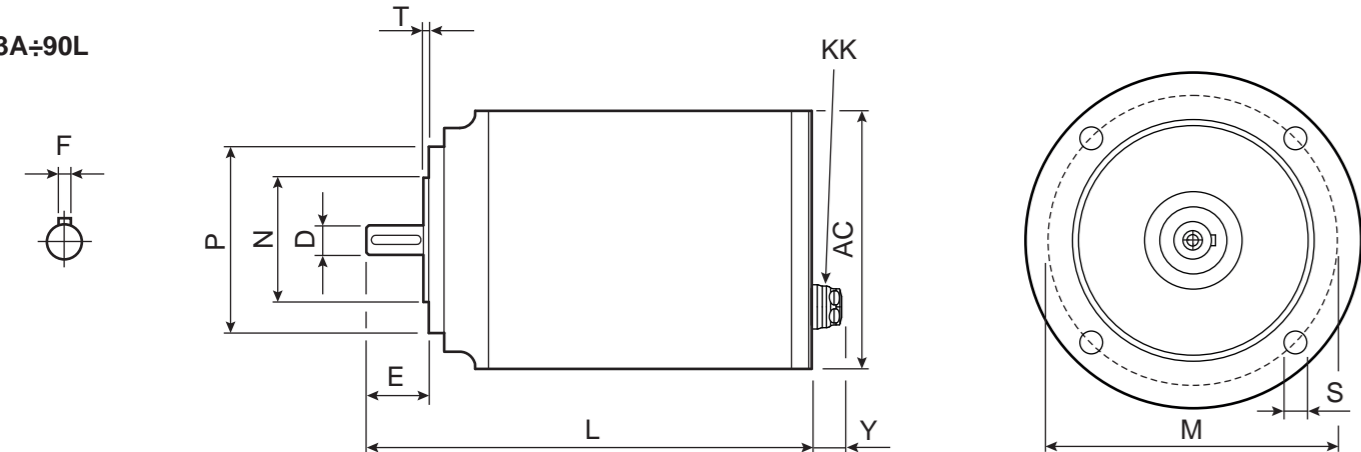

**100LA**

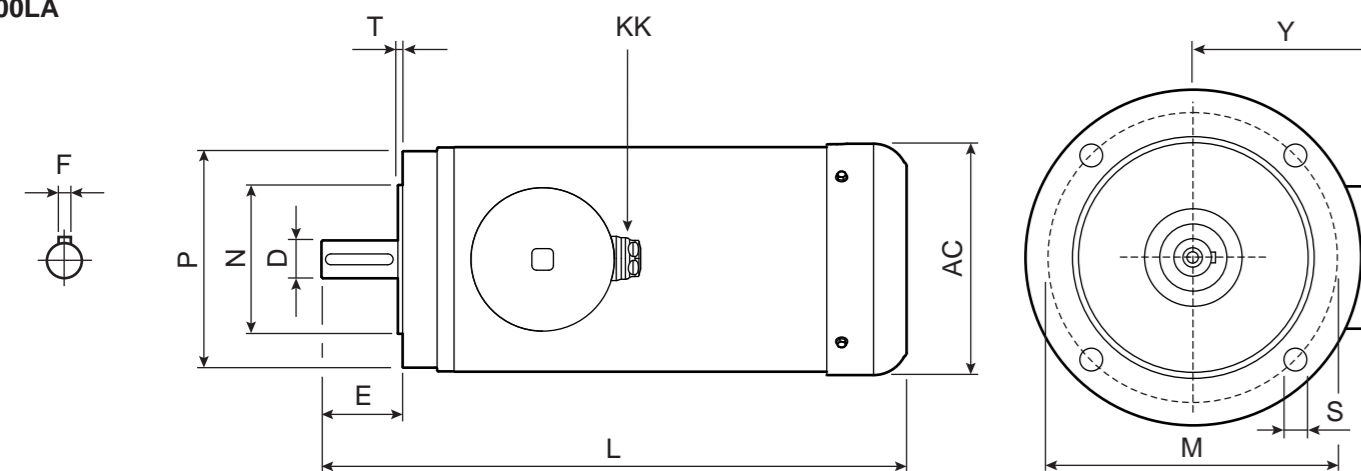

4 poles B14

Motor	kW	IE3	rpm (min <sup>-1</sup> )	Nm	A (400V)	COS (φ)	D	F	E	L	AC	Y	N	M	P	T	S	SPM		APM	
																		KK	Kg	KK	Kg
<b>63A</b>	0.12		1440	0.80	0.44	0.57	11 j6 M4	4	23	229	131	24	60 j6	75	90	2.5	4xM5	M16x1.5 ø7.5-10	8.7	M16x1.5 ø4-8	6.9
<b>63B</b>	0.18		1440	1.19	0.58	0.62	11 j6 M4	4	23	244	131	24	60 j6	75	90	2.5	4xM5	M16x1.5 ø7.5-10	10.0	M16x1.5 ø4-8	8.0
<b>71A</b>	0.25		1440	1.66	0.72	0.64	14 j6 M5	5	30	266	131	27	70 j6	85	105	2.5	4xM6	M20x1.5 ø11-13.5	11.6	M20x1.5 ø6-12	9.4
<b>71B</b>	0.37		1440	2.45	1.10	0.64	14 j6 M5	5	30	286	131	27	70 j6	85	105	2.5	4xM6	M20x1.5 ø11-13.5	13.5	M20x1.5 ø6-12	11.1
<b>80A</b>	0.55		1460	3.60	1.50	0.67	19 j6 M6	6	40	280	166	27	80 j6	100	120	3	4xM6	M20x1.5 ø11-13.5	19.0	M20x1.5 ø6-12	15.3
<b>80B</b>	0.75		1460	4.91	2.10	0.67	19 j6 M6	6	40	305	166	27	80 j6	100	120	3	4xM6	M20x1.5 ø11-13.5	22.0	M20x1.5 ø6-12	18.0
<b>90S</b>	1.1		1460	7.20	2.90	0.70	24 j6 M8	8	50	345	166	30	95 j6	115	140	3	4xM8	M25x1.5 ø15-18	27.0	M25x1.5 ø13-18	22.7
<b>90L</b>	1.5		1460	9.81	4.00	0.70	24 j6 M8	8	50	390	166	30	95 j6	115	140	3	4xM8	M25x1.5 ø15-18	33.0	M25x1.5 ø13-18	28.4
<b>100LA*</b>	2.2		1440	14.6	4.80	0.79	28 j6 M10	8	60	432.5	171	140	110 j6	130	160	3.5	4xM8	M20x1.5 ø11-13.5	34.0	M20x1.5 ø11-13.5	-

\* APM Series not available  
 \* Serie APM non disponibile

# APM FEATURES

Caratteristiche

## Aluminum premium electric motors

Motori elettrici in alluminio



# APM FEATURES

Caratteristiche

# SPM FEATURES

Caratteristiche

## Stainless steel premium electric motors

Motori elettrici in acciaio inox



# SPM FEATURES

Caratteristiche



**Electrical motors of the APM series have no cooling fins and are treated with the innovative "Hi-Cleaning" coating applying nano particles (patented system), which makes the surface very easy to clean and resistant to major aggressive agents used in sanitizing.**

*La gamma APM non ha alette di raffreddamento ed è trattata con un innovativo rivestimento «Hi-Cleaning» alle nano particelle (sistema brevettato) che rende la superficie estremamente facile da pulire e resistente ai principali agenti aggressivi usati nella sanificazione.*



**Totally enclosed and non-ventilated (IC410) design along with completely smooth surfaces ensures the highest hygienic standards.**

*Totamente chiuso, non ventilato (IC410), le superfici completamente lisce garantiscono gli standard di igienicità più elevati richiesti dal mercato.*



**All external components are manufactured in AISI 316L stainless steel while motor shaft is made of 420 stainless steel with magnetic properties. Completely smooth surfaces with nothing to break off and excellent resistance to corrosion represent a reliable and durable solution for numerous applications where hygiene and cleanliness are essential.**

*Tutti i componenti esterni sono realizzati in acciaio inox AISI 316L, l'albero motore è in acciaio inox 420 con proprietà magnetiche. Tutte le superfici sono completamente lisce. Questo dà eccellente resistenza alla corrosione e una soluzione affidabile e duratura laddove l'igiene è fondamentale.*



**Totally enclosed and non-ventilated (IC410) design along with completely smooth surfaces ensures the highest hygienic standards.**

*Totamente chiuso non ventilato (IC410), le superfici completamente lisce garantiscono gli standard di igienicità più elevati richiesti dal mercato.*



**All external components are manufactured in aluminium while motor shaft is produced in 420 stainless steel with magnetic properties and all screws are made of 316L stainless steel.**

*Tutti i componenti esterni sono realizzati in alluminio, l'albero motore è in acciaio AISI420 con proprietà magnetiche, tutte le viterie in AISI316L.*



**The surface temperature is rather low thanks to an accurate electromagnetic design and additional internal active material. The efficiency class is IE3.**

*La temperatura di superficie è contenuta grazie ad una progettazione accurata. La classe di efficienza è IE3 (≥ 0.75kW).*



**Stainless steel Hygienic cable gland certified EHEDG.**

*Pressacavo in acciaio inox, con design igienico, certificato EHEDG.*



**The surface temperature is rather low thanks to an accurate electromagnetic design and additional internal active material. The efficiency class is IE3.**

*La temperatura di superficie è contenuta grazie ad una progettazione accurata. La classe di efficienza è IE3 (≥ 0.75kW).*



**Standard plastic Hygienic cable gland.**

*Pressacavo "igienico" standard in plastica.*



**Pipe housing without weldings and terminal box on the NDE enhance the impact of an eye-catching design.**

*Carcassa tubolare senza saldature, coprimorsettiera posteriore e look accattivante.*



**Product label is laser engraved.**

*Targhetatura laser sul coperchio posteriore.*



**Pipe housing without weldings and terminal box on the NDE enhance the impact of an eye-catching design.**

*Carcassa tubolare senza saldature, coprimorsettiera posteriore e look accattivante.*



**Product label on the back cover**

*Targhetta sul coperchio posteriore.*



**Motors are suitable for INVERTER DUTY OPERATION with large range at constant torque, thanks to low loss laminations, vacuum impregnation of the windings and inverter duty magnet wires. Stator and rotor are coated with anti-oxidant painting.**

*I motori sono idonei al funzionamento con INVERTER con ampio range a coppia costante, grazie a lamierini a basse perdite e all'impregnazione degli avvolgimenti sottovuoto. Statore e rotore sono rivestiti con vernice antiossidante.*



**IP69K is guaranteed by Viton oil seals and O-rings.**

*Anelli di tenuta e O-Rings in Viton garantiscono un grado di protezione IP69K.*



**Motors are suitable for INVERTER DUTY OPERATION with large range at constant torque, thanks to low loss laminations, vacuum impregnation of the windings and inverter duty magnet wires. Stator and rotor are coated with anti-oxidant painting.**

*I motori sono idonei al funzionamento con INVERTER con ampio range a coppia costante, grazie a lamierini a basse perdite e all'impregnazione degli avvolgimenti sottovuoto. Statore e rotore sono rivestiti con vernice antiossidante.*



**Easy connection with Wire-to-Wire heat-shrinkable splicings.**

*L'utilizzo di connettori testa-testa termo-sigillanti rende semplice il collegamento dei cavi.*



**NDE bearing is axially locked. Precise mechanical execution.**

*Cuscinetto posteriore bloccato assialmente, esecuzione meccanica precisa.*



**Easy connection with Wire-to-Wire heat-shrinkable splicings.**

*L'utilizzo di connettori testa-testa termo-sigillanti rende semplice il collegamento dei cavi.*



**NDE bearing is axially locked. Precise mechanical execution.**

*Cuscinetto posteriore bloccato assialmente, esecuzione meccanica precisa.*