



THREE PHASE
INDUCTION MOTOR



TYPE			IP		INS.CL.F N ⁰			
CONN	V	Hz	kW	HP	r/min	A		
Power factor			Duty		Standard			

Terminal marking / connections

Three-phase motors

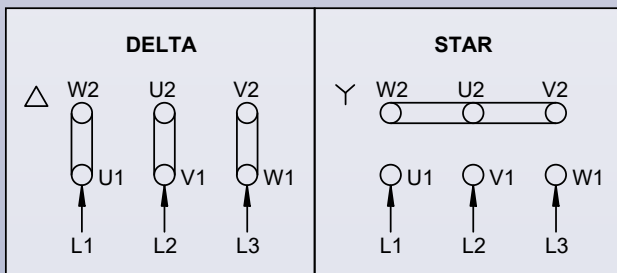

Two-speed motors

Dahlander-connection
750-1500 and 1500-3000rpm

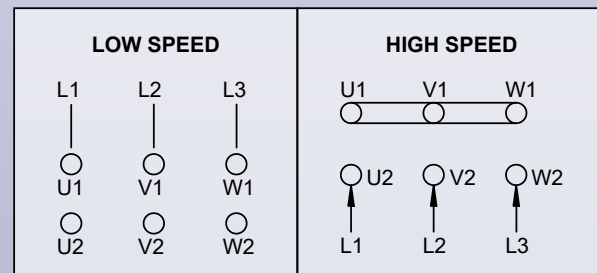

Seperate windings

1000-1500, 750-3000 and 750-1000

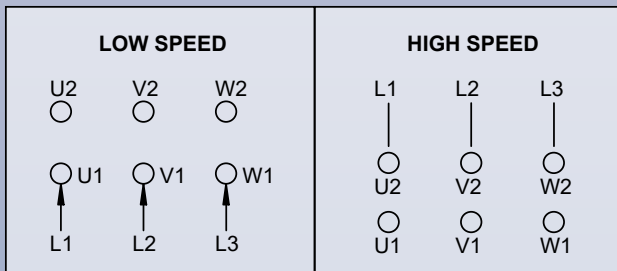

General Features

High efficiency motors

The Techtot motors are designed with the new European standard for high efficiency.

MS line, is designed and manufactured in according to the parameters of the new international standard 60034–30–1 for efficiency IE1, IE2

TA and TC lines, are designed and manufactured in accordance with the parameters of the int. standard 60034–30–1 for efficiency IE1, IE2, IE3, IE4

The motors are totally enclosed, fan cooled, with squirrel cage rotor.

MS and TA lines, from frame 56 to frame 200, are with aluminium frame.

TC line, from frame 80 to frame 355, is with cast iron frame.

IEC 60034–30–1 standard defines IE (International Efficiency) efficiency classes of single speed three-phase cage induction motors; 50Hz and 60Hz; 2,4,6,8, pole; rated voltage up to 1000V; S1 duty in the new standard.

- IE1 standard efficiency
- IE2 high efficiency from 0.12 to 375 kW
- IE3 premium efficiency from 0.12 to 375 kW
- IE4 super premium efficiency form 0.12 to 375kW

Rated Power kW	(IE1) Standard Efficiency				(IE2) High Efficiency				(IE3) Premium Efficiency				(IE4) Super Premium Efficiency			
	Poli-Poles				Poli-Poles				Poli-Poles				Poli-Poles			
	2	4	6	8	2	4	6	8	2	4	6	8	2	4	6	8
0.12	45.0	50.0	38.3	31.0	53.6	59.1	50.6	39.8	60.8	64.8	57.7	50.7	66.5	69.8	64.9	62.3
0.18	52.8	57.0	45.5	38.0	60.4	64.7	56.6	45.9	65.9	69.9	63.9	58.7	70.8	74.7	70.1	67.2
0.25	58.2	61.5	52.1	43.4	64.8	68.5	61.6	50.6	69.7	73.5	68.6	64.1	74.3	77.9	74.1	70.8
0.37	63.9	66.0	59.7	49.7	69.5	72.7	67.6	56.1	73.8	77.3	73.5	69.3	78.1	81.1	78.0	74.3
0.55	69.0	70.0	65.8	56.1	74.1	77.1	73.1	61.7	77.8	80.8	77.2	73.0	81.5	83.9	80.9	77.0
0.75	72.1	72.1	70.0	61.2	77.4	79.6	75.9	66.2	80.7	82.5	78.9	75.0	83.5	85.7	82.7	78.4
1.1	75.0	75.0	72.9	66.5	79.6	81.4	78.1	70.8	82.7	84.1	81.0	77.7	85.2	87.2	84.5	80.8
1.5	77.2	77.2	75.2	70.2	81.3	82.8	79.8	74.1	84.2	85.3	82.5	79.7	86.5	88.2	85.9	82.6
2.2	79.7	79.7	77.7	74.2	83.2	84.3	81.8	77.6	85.9	86.7	84.3	81.9	88.0	89.5	87.4	84.5
3	81.5	81.5	79.7	77.0	84.6	85.5	83.3	80.0	87.1	87.7	85.6	83.5	89.1	90.4	88.6	85.9
4	83.1	83.1	81.4	79.2	85.8	86.6	84.6	81.9	88.1	88.6	86.8	84.8	90.0	91.1	89.5	87.1
5.5	84.7	84.7	83.1	81.4	87.0	87.7	86.0	83.8	89.2	89.6	88.0	86.2	90.9	91.9	90.5	88.3
7.5	86.0	86.0	84.7	83.1	88.1	88.7	87.2	85.3	90.1	90.4	89.1	87.3	91.7	92.6	91.3	89.3
11	87.6	87.6	86.4	85.0	89.4	89.8	88.7	86.9	91.2	91.4	90.3	88.6	92.6	93.3	92.3	90.4
15	88.7	88.7	87.7	86.2	90.3	90.6	89.7	88.0	91.9	92.1	91.2	89.6	93.3	93.9	92.9	91.2
18.5	89.3	89.3	88.6	86.9	90.9	91.2	90.4	88.6	92.4	92.6	91.7	90.1	93.7	94.2	93.4	91.7
22	89.9	89.9	89.2	87.4	91.3	91.6	90.9	89.1	92.7	93.0	92.2	90.6	94.0	94.5	93.7	92.1
30	90.7	90.7	90.2	88.3	92.0	92.3	91.7	89.8	93.3	93.6	92.9	91.3	94.5	94.9	94.2	92.7
37	91.2	91.2	90.8	88.8	92.5	92.7	92.2	90.3	93.7	93.9	93.3	91.8	94.8	95.2	94.5	93.1
45	91.7	91.7	91.4	89.2	92.9	93.1	92.7	90.7	94.0	94.2	93.7	92.2	95.0	95.4	94.8	93.4
55	92.1	92.1	91.9	89.7	93.2	93.5	93.1	91.0	94.3	94.6	94.1	92.5	95.3	95.7	95.1	93.7
75	92.7	92.7	92.6	90.3	93.8	94.0	93.7	91.6	94.7	95.0	94.6	93.1	95.6	96.0	95.4	94.2
90	93.0	93.0	92.9	90.7	94.1	94.2	94.0	91.9	95.0	95.2	94.9	93.4	95.8	96.1	95.6	94.4
110	93.3	93.3	93.3	91.1	94.3	94.5	94.3	92.3	95.2	95.4	95.1	93.7	96.0	96.3	95.8	94.7
132	93.5	93.5	93.5	91.5	94.6	94.7	94.6	92.6	95.4	95.6	95.4	94.0	96.2	96.4	96.0	94.9
160	93.8	93.8	93.8	91.9	94.8	94.9	94.8	93.0	95.6	95.8	95.6	94.3	96.3	96.6	96.2	95.1
200	94.0	94.0	94.0	92.5	95.0	95.1	95.0	93.5	95.8	96.0	95.8	94.6	96.5	96.7	96.3	95.4
250	94.0	94.0	94.0	92.5	95.0	95.1	95.0	93.5	95.8	96.0	95.8	94.6	96.5	96.7	96.5	95.4
315	94.0	94.0	94.0	92.5	95.0	95.1	95.0	93.5	95.8	96.0	95.8	94.6	96.5	96.7	96.6	95.4
355–375	94.0	94.0	94.0	92.5	95.0	95.1	95.0	93.5	95.8	96.0	95.8	94.6	96.5	96.7	96.6	95.4

Standards

Motors MS, TA, TC series are complied with the following Standards

Ratings and performances

IEC 60034-1 CEI EN 60034-1

Methods for determining losses and efficiency

IEC 60034-2-1 CEI EN 60034-2

Rotating electrical machines, part 30, efficiency classes of single speed, three-phase induction motors (ie code)

IEC 60034-30-1 EDITION 1

Classification of degrees of protection (ip code)

IEC 60034-5 CEI EN 60034-5

Methods of cooling (ic code)

IEC 60034 - 6 CEI EN 60034-6

Classification of type of construction mounting arrangements (im code)

IEC 60034-7 CEI EN 60034-7

Terminal markings and direction of rotation

IEC 60034-8 CEI 2-8

Noise limits

IEC 60034-9 CEI EN 60034- 9

Built-in thermal protections

IEC 60034-11

Starting performance of rotating electrical machines

IEC 60034- 12 CEI EN 60034 - 12

Mechanical vibrations

IEC 60034-14 CEI EN 60034-14

Dimensions and outputs for electrical machines

CEI EN50347 IEC 60072-1 IEC 60072-2

Mounting and Positions

Frame according to IEC 60034-7, are defined in the following table:

FIGURE	STANDARDS			FRAME SIZES		
	CEI 2-14	Code I	Code II	56-160	180-280	315-355

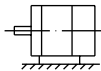
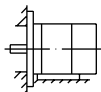
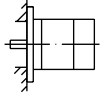
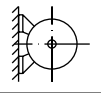
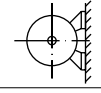
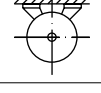
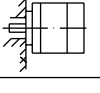
	B3	IM B3	IM 1001	standard		
	B3/B5	IM B35	IM 2001	standard		
	B5	IM B5	IM 3001	standard	standard	upon request
	B6	IM B6	IM 1051	standard	upon request	upon request
	B7	IM B7	IM 1061	standard	upon request	upon request
	B8	IM B8	IM 1071	standard	upon request	upon request
	B14	IM B14	IM 3601	standard		

	V1	IM V1	IM 3011	standard		
	V3	IM V3	IM 3031	standard	standard	upon request
	V5	IM V5	IM 1011	upon request	upon request	upon request
	V6	IM V6	IM 1031	upon request	upon request	upon request
	V1/V5	IM V15	IM 2011	standard	standard	upon request
	V18	IM V18	IM 3611	standard		
	V19	IM V19	IM 3631	standard		

Protection

The motors protection degrees according to IEC 60034-5 standards, are:

IP 55 (standard) totally enclosed motors, fan cooled, protected against penetration of dust and water splashes coming from any direction

IP 56 (upon request) totally enclosed motors, protected against dust penetration and against sea waves, for use on deck.

Normally IP56 also IP55 motors are supplied with external fan (IC 411 - IC 416 or IC 418). Upon request they can be supplied without fan. (IC410). In this case the features, outputs and technical data will be supplied upon request.

The external fan is covered, in line with safety standards.

Motors for vertical mounting V1, V5, V1/V5, are supplied with rain cowl.(optional)

The terminal box, in aluminium or cast iron, has IP 55 or IP56 protection degree.

General Construction Features

The motors have been designed and manufactured in compliance with international standards.

TA and MS series are available from frame size 56 to frame size 200

Frame and terminal box are in aluminum, fan cover is in sheet steel, flanges and shields are in aluminum.

TC series is available from frame size 80 to frame size 355.

Frame and terminal box are in cast iron, fan cover is in sheet steel, flanges and shields are in cast iron.

The terminal box, standard is on the top of the motor, which can be rotated in step of 90°, but can only rotate the position of the gland not the position of the T/BOX.

Fans are in nylon, upon request can be supplied with aluminium or steel sheet.

Feet are removable, on all series, from frame size 56 to frame size 280.

Cooling

The designation of cooling method is given by the IC (International Cooling) code, according to IEC 60034-6

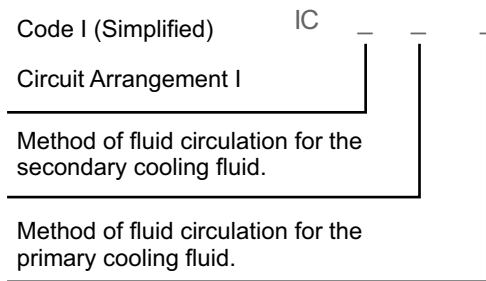

Motors in standard execution of frame sizes from 56 to 355 are supplied with IC 411 cooling systems, incorporating a bidirectional fan.

All frame sizes can be supplied with cooling system IC 416 on request.

In this case a proper fan is fitted inside the fan cover, suitably reinforced, in order to make the ventilation independent of the rotation speed.

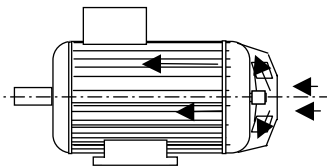
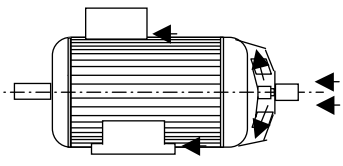
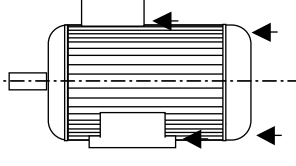
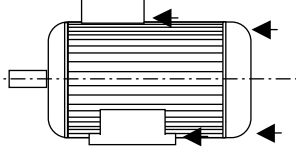
IC CODE	FIGURE	DESCRIPTION	NOTE
IC 411		Self ventilating motor. Enclosed machine. Fan mounted on motor shaft end	Standard
IC 416		Motor with forced ventilation. Enclosed machine. Independent external fan mounted inside the fan cover.	Upon request
IC 418		Motor with external ventilation. Enclosed machine. Provided by air flowing from the driven system.	Upon request
IC 410		Non ventilated motor Enclosed machine.	Upon request

Bearings and Oil Seals

Motors TA and MS series from frame size 56 to frame size 200 have sealed pre-lubricated ball bearings, DE and NDE side, C3. Motors TC series frame size 132 have sealed pre-lubricated ball bearings, DE and NDE side, C3. Motors TC series from frame size 160 to frame size 280 (including 315 2 pole) have ball bearings, DE and NDE, C3. Motors TC series from frame size 315 (4,6,8 pole) to frame size 355, have roller bearings DE side and ball bearings NDE side.

All non pre-lubricated bearings need to periodically re-lubricated according to the data give in the motors maintenance manuals.

Motor with bearing axial constrains have an arrangement with a spring in order to absorb vibrations.

The lifetime of bearings (in accordance with supplier data) is in excess of 40.000 hours, for motors with direct coupling.

In table are mentioned all specifications concerning bearings installed on motors frame size 56-355

MOTOR TYPE	Bearing		Oil seals
	Drive end	Non-drive end	dxDxB
MS 56	6201	6201	12x22x5
MS 63	6201	6201	12x24x5
MS 71	6202	6202	15x25x7
MS 80	6204	6204	20x34x7
MS 90	6205	6205	25x37x7
MS 100	6206	6206	30x44x7
MS 112	6306	6206	30x44x7
MS 132	6308	6208	40x58x7
MS 160	6309	6309	45x65x8
MS 180	6311	6211	55x72x8
MS 200	6312	6212	60x80x8
TA 56	6201	6201	12x22x5
TA 63	6201	6201	12x22x5
TA 71	6202	6202	15x25x7
TA 80	6204	6204	20x34x7
TA 90	6205	6205	25x37x7
TA 100	6206	6206	30x44x7
TA 112	6306	6206	30x44x7
TA 132	6308	6208	40x58x7
TA 160	6309	6209	45x65x8
TA 180	6311	6211	55x72x8
TA 200	6312	6212	60x80x8

MOTOR TYPE	Bearing		Oil seals
	Drive end	Non-drive end	dxDxB
TC 80	6204	6204	20x34x7
TC 90	6205	6205	25x37x7
TC 100	6206	6206	30x44x7
TC 112	6306	6306	30x44x7
TC 132	6308	6308	40x58x7
TC 160	6309	6309	45x65x8
TC 180	6311	6311	55x75x8
TC 200	6312	6312	60x80x8
TC 225	6313	6313	65x90x10
TC 250	6314	6314	70x95x10
TC 280	6316	6316	80x100x10
TC 315-2	6317	6317	85x110x12
TC 315-4/6/8	NU319	6319	95x120x12
TC 355-2	6319	6319	95x120x12
TC 355-4/6/8	NU322	6322	110x130x12

Upon request can be mounted, roller bearings at DE side, where non-standard, insulated bearings at NDE side, and reinforced bearings at NDE side.

Terminal Box

The terminal board is normally equipped with 6 terminal and is made with non hygroscopic and middle resistance material.

Terminal box for TA and MS series is made in aluminum, in cast iron for TC series.

Terminal box has IP 55 standard protection degree or IP56.

Generally. Cable gland with the following dimensions is provided for:

FRAME	Cable gland	FRAME	Cable gland
TA/MS 56	1-M16x1,5	TC 80	1-M20x1,5
TA/MS 63	1-M16x1,5	TC 90	1-M20x1,5
TA/MS 71	1-M20x1,5	TC 100	2-M20x1,5
TA/MS 80	1-M20x1,5	TC 112	2-M20x1,5
TA/MS 90	1-M20x1,5	TC 132	2-M25x1,5
TA/MS 100	2-M20x1,5	TC 160	2-M32x1,5
TA/MS 112	2-M25x1,5	TC 180	2-M32x1,5
TA/MS 132	2-M25x1,5	TC 200	2-M40x1,5
TA/MS 160	2-M32x1,5	TC 225	2-M50x1,5
TA/MS 180	2-M40x1,5	TC 250	2-M50x1,5
TA/MS 200	2-M40x1,5	TC 280	2-M50x1,5
		TC 315	2-M63x1,5
		TC 355	2-M63x1,5

Connection

Single speed motors

Connection star Y
highest voltage on plate

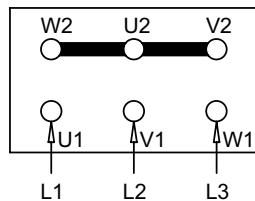

Connection delta Δ
lower voltage on plate

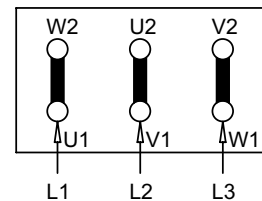

Double speed motors

single winding
6 terminals

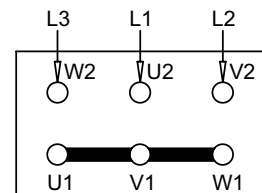
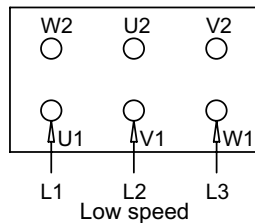

High speed

Two separate windings
6 terminals

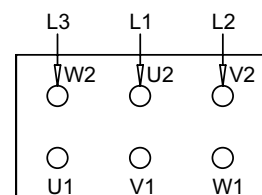
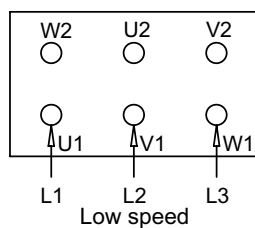

High speed

Insulation, Winding

The motors of the series MS,TA,TC are made in F insulation class.

The soft copper electrolytic wire is insulated by using a special enamel (double enamel). Such enamel is classified as insulation class.

All insulating materials used to produce motors are in F or H insulation class.

The winding undergoes a treatment as follows: it is impregnated by soaking it in oven-curing F class resins, it is tropicalized following a process including a spraying of anti-salty enamel and, finally, it is coated using a spray with heatproof, humidity-proof, chemical agent and sea-ambient corrosive action resistant characteristics.

The impregnation cycle is carried out under vacuum.

Ratings and Technical Data

Power and data reported in the Technical Data Tables are for continuous duty (S1) at an ambient temperature of 40 C, max. altitude 1000 a.s.l., with supply at 400 V - 50Hz.

In such conditions, the temperature rise reached by the motors lower than the one provided for by the B insulation class.

The operating characteristics are guaranteed with the tolerances defined by the CEI EN 60034-1 Standards and the IEC 60034-1 Recommendations, reported in the table

CHARACTERISTICS	TOLERANCES
Efficiency	Motor power < 50 kW -15% of (1- η) Motor power > 50 kW -10% of (1- η)
Power factor	+1/6 (1- $\cos\phi$) Min 0.02 Max 0.07
Locked rotor current	+20% of guaranteed value
Locked rotor torque	-15% + 25% of guaranteed value
Pull out torque	-10% of guaranteed value
Slip	\pm 20% of guaranteed value

Supply Voltage

The motors, series MS,TA,TC from frame size 56 to frame size 250 are designed to be used for supply at rated voltages from 220V to 690V at 50Hz and at 60Hz, motors from frame size 280 to frame size 355 are designed to be used for supply at rated voltages from 400V to 690V at 50Hz and at 60 Hz.

Standard rated voltages of the motors usually in stock are:

from frame size 56 to frame size 100, 230/400V 50Hz

from frame size 112 to frame size 355, 400/690V 50Hz

Lower voltage is made with delta connection while the higher voltage is made with star connection.

In these supply conditions efficiencies are in compliance with the IEC 60034-30-1.

Voltage and Frequency Variations

Motors can work without failures if the supply voltage variations are limited as stated in the Classification Society Standards.

In particular, motors can run with voltage variations of 10% and frequency variations of 5% with a maximum combined variation of 10% with temperature rise in compliance with the provisions of the Classification Society Standards.

Operation at 60Hz Frequency

The motors can run with a frequency of 60 Hz with differences in performances and electrical ratings by applying the multiplier value as described in the table below. For motors made at 50Hz and supply at 60Hz, efficiency class of the motor at 50Hz is no longer valid.

PLATE VOLTAGE	PLATE VOLTAGE	NOMINAL POWER	NOMINAL CURRENT	NOMINAL TORQUE	RPM	STARTING CURRENT	STARTING TORQUE	MAX TORQUE
50 HZ	60 HZ							
230 +/- 10%	220 +/- 5%	1	1	0.83	1.2	0.83	0.83	0.83
230 +/- 10%	230 +/- 10%	1	0.95	0.83	1.2	0.83	0.83	0.83
230 +/- 10%	254 +/- 5%	1.15	1.02	0.96	1.2	0.93	0.93	0.93
230 +/- 10%	277 +/- 5%	1.2	1	1	1.2	1	1	1
400 +/- 10%	380 +/- 5%	1	1	0.83	1.2	0.83	0.83	0.83
400 +/- 10%	400 +/- 10%	1	0.95	0.83	1.2	0.83	0.83	0.83
400 +/- 10%	440 +/- 5%	1.15	1.02	0.96	1.2	0.93	0.93	0.93
400 +/- 10%	460 +/- 10%	1.15	1	0.96	1.2	0.96	0.96	0.96
400 +/- 10%	480 +/- 5%	1.2	1	1	1.2	1	1	1

Deratings

The tables of technical data are referred to an ambient temperature of 40°C and an altitude up to 1000 a.s.l. In different environmental conditions output ratings vary, and are obtainable by applying the factors as mentioned in the following table, maintaining the temperature rise provided for by the B insulation class.

ALTITUDE M A.S.L	AMBIENT TEMPERATURE (°C)					
	30	30-40	45	50	55	60
<= 1000	1.06	1	0.97	0.94	0.90	0.87
1500	1.04	0.97	0.94	0.91	0.87	0.84
2000	1	0.95	0.92	0.88	0.84	0.81
3000	0.96	0.89	0.86	0.82	0.78	0.74
4000	0.91	0.84	0.80	0.76	0.72	0.67

In case the temperature rise permitted for the F insulation class is used, the corrective factors are the same mentioned in the following table:

ALTITUDE M A.S.L	AMBIENT TEMPERATURE (°C)					
	30	30-40	45	50	55	60
<= 1000	1.17	1.12	1.09	1.06	1.03	1
1500	1.15	1.10	1.07	1.04	1.01	0.97
2000	1.13	1.07	1.04	1.01	0.98	0.95
3000	1.08	1.02	0.99	0.96	0.93	0.89
4000	1.04	0.97	0.94	0.91	0.87	0.84

All technical data reported in the tables are referred to continuous duty (S1). Upon request, motors for limited Duty S2 (30 or 60 minutes) can be supplied.

Overloads

Continuous duty motors can withstand the following overloads

OVERLOAD %	DURATION MINUTES	TIME INTERVAL MINUTES
10	10	15
20	6	15
30	4	15
40	3	15
50	2	15

In these operating overloads conditions, over temperature are than the limits of the insulation class F.

Starting

Motors are suitable for the following types of starting:

- Direct
- Star - delta
- By autotransformer
- Soft-start (*)
- by inverter (**)

(*)when the starting is finished soft-start should be by-passed, or precaution must be used the same when the motor powered with inverter

(**) see as recommended in the paragraph n.23 “Inverter Supply”

Vibration

Motors are dynamically balanced with a half key applied to the shaft extension in accordance with standard IEC 60034-14:2007 to vibration severity grade normal (N) in standard execution.

The following table indicates the maximum vibration grades with respect to the different shaft heights.

Vibration degree	Frame size (mm)	56 ≤ H ≤ 132	132 < H ≤ 280	H > 280
	Mounting type	Speed/ (mm/s)	Speed/ (mm/s)	Speed/ (mm/s)
A	Suspension	1.5	2.2	2.8
	Rigid mounting	1.3	1.8	2.3

Noise

The technical features table contains the values of A-sound pressure level (LpA) and A sound power level (LwA), measured at a one meter distance.

Sound levels are measured in no-load conditions and have tolerances of 3 dB(A).

FRAME SIZE	A-sound pressure level (LpA) · A-sound power level (LwA) dB(A)							
	2POLES		4POLES		6POLES		8POLES	
	LpA	LwA	LpA	LwA	LpA	LwA	LpA	LwA
56	69	78	63	72	58	67	54	63
63	75	84	67	76	61	70	58	67
71	75	84	67	76	61	70	58	67
80	75	84	70	79	63	72	61	70
90	75	85	70	80	66	76	66	76
100	77	87	70	80	66	76	66	76
112	78	88	73	83	66	76	66	76
132	69	78	63	72	58	67	54	63
160	75	84	67	76	61	70	58	67
180	75	84	67	76	61	70	58	67
200	75	84	70	79	63	72	61	70
225	75	85	70	80	66	76	66	76
250	77	87	70	80	66	76	66	76
280	78	88	73	83	66	76	66	76
315	80	90	77	87	73	83	69	79
355	86	97	84	96	82	94	79	91

The values of the noise (LpA) and of the sound power (LwA) in the table are related to the operation at 50Hz, when the frequency changes these values change how indicated in the following tabel:

SUPPLY FREQUENCY HZ	% VALUE OF THE NOISE LEVEL COMPARED TO THE 50HZ VALUE
10	60%
20	60%
30	70%
40	100%
50	100%
60	100%
80	120%

Thermal Protections

All the Techtot motors from frame size 160 to frame size 355 have installed the positive temperature coefficient thermistors PTC. These protections change its standard resistance value, Upon request, these protection, will be installed from frame size 56 to frame size 132.

Resistance of PTC, for nominal operating temperature (T), will be satisfy the following value:

- < 250 Ohm at a temperature from -20°C to TK-20°C
- < 550 Ohm at a temperature of TK-5°C
- > 1330 Ohm at a temperature of TK+5°C
- > 4000 Ohm at a temperature of TK+15°C

Values of TK related with the class of insulation are the following:

CLASS OF INSULATION	OPERATING TEMPERATURE LIMIT OF THE INSULATION °C	TK °C
A	105	95-100
E	120	110-115
B	130	120-125
F	155	145-150
H	180	170-175

The nominal operating temperature of the thermistors PTC, mounted on the Techtot motors is 150' C, maximum supply voltage of the PTC theristors is 2,5V.

Below the characteristic resistance/ temperature of the PTC thermistors:

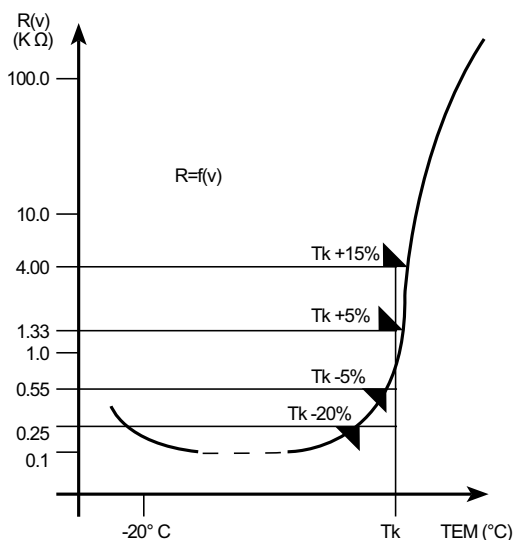

Upon request, the following thermal protections can be installed on the motors:

Bimetallic devices

Motor protectors with contact normally closed. The contact opens when the winding temperature reaches limits dangerous to the insulation system of the motor.

Platinum resistance thermometers PT100

Variable linear resistance with the winding temperature. Device particularly suitable for a continuous winding temperature monitoring.

The protection is normally made by 3 sensitive elements, one for each phase, and with two terminals in a specially provided terminal board located in the main terminal box or in a specially provided auxiliary terminal box.

Anticondensation heaters

Motors subject to atmospheric condensation, either through standing idle in damp environments or because of wide ambient temperature variations, may be fitted with anticondensation heaters.

They are of tape form and are normally mounted on the stator winding head.

Anticondensation heaters are normally switched on automatically when the supply to the motor is interrupted, heating the motor to avoid water condensation.

Normal supply voltage is 115 V or 220/240V.

Anticondensation heater terminals are led to a specially provided terminal board located in the main terminal box.

Upon request they can be led to a terminal board located in an auxiliary terminal box.

The power values normally used are shown in the table :

FRAME SIZE	POWER (W)
132-160	26
180-200	26
225-250	50
280-315	100
355	200

Drainage hole

Motors of series MS, TA, TC are provided with holes for the discharge of condensate closed with a plug to guarantee the degree of protection IP reported on plate.

As a function of the operating conditions such plugs can be removed to allow the discharge of condensate that may form inside the motor.

Converter Fed Application

TECHTOP low voltage motors are suitable for pumps, fans, compressors, textile machine and mechanical machine applications where variable or constant speed is required.

In application where the motor is driven by a converter, the degree of electrical interference depends on the type of converter used (type, number of IGBTs, interference suppression measures, and manufacturer), cabling, distance and application requirements.

The installation guidelines of the converter manufacturer with regards to electromagnetic compatibility must be considered at all times during the design and implementation phases.

At rated output with converter fed operation, the motors will be used in temperature class 155 (F). To prevent damage as a result of bearing currents, insulated bearings are recommended to be assembled for FS250 ~ 315. Please inquire Techtop about the detailed information of insulated bearing.

Converter-fed Operation

The standard insulation of TECHTOP low voltage motors is designed such that operation is possible on the converter at mains voltage up to 480 V.

The load torque characteristics of this series motor is referred in the following diagram:

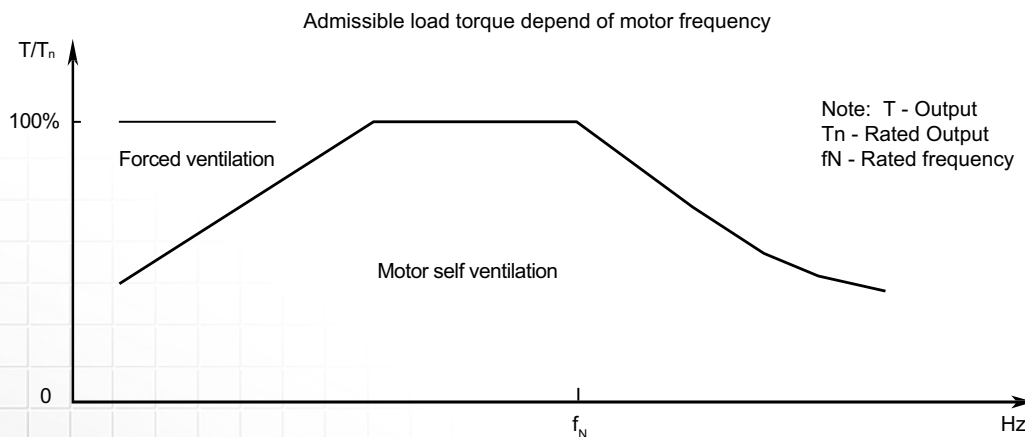

By usage with admissible torque and below, the motor can be operated with self cooling; by usage over the admissible torque line, the motor with forced ventilation is needed.

At operating speeds above rated speed the noise and vibration levels increase and the bearing life time reduce. Attention should be paid to the re-greasing intervals and the grease service life.

For converter-fed operation with frequencies greater than 60 Hz special balancing is required for compliance with the specified limit values.

Voltage Withstand Levels

The dielectric stress of the winding insulation is determined by:

- the peak voltage, rise time and frequency of the impulses produced by the converter.
- the characteristics and the length of the connection leads between the converter and motor.
- the winding construction and other system parameters, especially the voltages between the different parts of the winding and the ground represent dielectric stress at the insulation system.

The standard insulation of the 1LE0003 motors is designed to withstand voltage peak and rise time which is showed in the diagram:

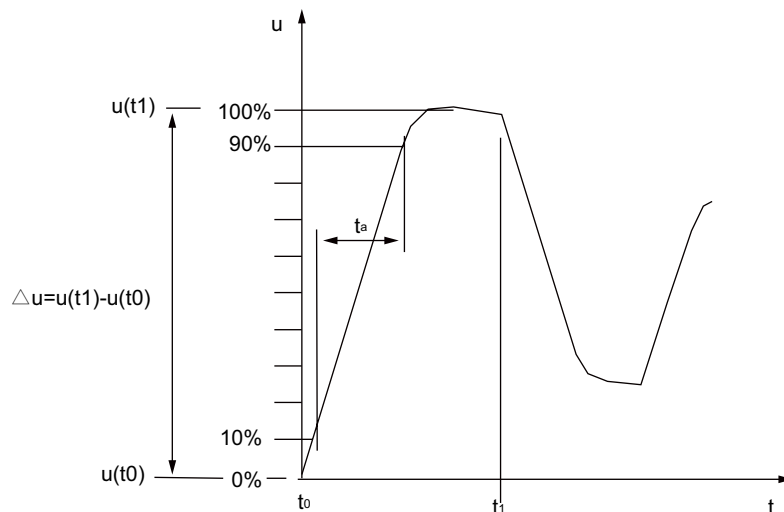
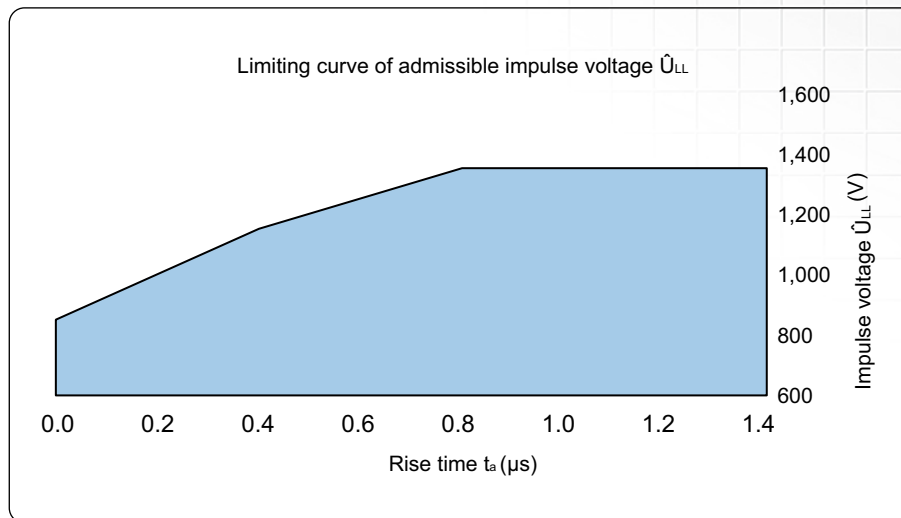

The values refer to standard IEC 60034-17 and GB/T 20161-2008.

Auxiliary Fans

All frame sizes can be supplied with cooling system IC 416 (forced ventilation) on request.

Consequently the ventilation is independent of the rotation speed of the motor itself.

This solution is particularly suitable for inverter supplied motors.

Auxiliary fans three phase

TYPE	SPEED (r/min)	MAXIMUM AIR FLOW (m ³ /h)	MAXIMUM PRESSURE (pa)	NOISE dB(A)
63	2800	45	40	62
71	2800	52	50	62
80	2800	58	60	62
90	2800	91	80	65
100	2750	142	80	67
112	2600	229	80	67
132	1400	337	35	69
160	1390	609	40	72
180	1330	686	55	72
200	1230	1679	65	72
225	1430	1786	70	74
250	1420	1813	80	75
280	1360	2415	85	78
315	1320	2820	110	81
355	900	3500	800	85

3PHASE (v)	INPUT CURRENT (A)	Hz	INPUT POWER (w)
230	0,12	50	20
230	0,14	50	25
230	0,14	50	29
230	0,16	50	32
230	0,29	50	58
230	0,31	50	69
230	0,33	50	52
230	0,43	50	70
230	0,43	50	85
230	0,46	50	105
230	0,62	50	75
230	0,66	50	115
230	0,94	50	180
230	1,3	50	480
230	1,65	50	400

TYPE	SPEED (r/min)	MAXIMUM AIR FLOW (m ³ /h)	MAXIMUM PRESSURE (pa)	NOISE dB(A)
63	2800	45	40	62
71	2800	52	50	62
80	2800	58	60	62
90	2800	91	80	65
100	2750	142	80	67
112	2600	229	80	67
132	1400	337	35	69
160	1390	609	40	72
180	1330	686	55	72
200	1230	1679	65	72
225	1430	1786	70	74
250	1420	1813	80	75
280	1360	2415	85	78
315	1320	2820	110	81
355	900	3500	800	85

3PHASE (v)	INPUT CURRENT (A)	Hz	INPUT POWER (w)
400	0,07	50	20
400	0,08	50	25
400	0,08	50	29
400	0,09	50	32
400	0,17	50	58
400	0,18	50	69
400	0,19	50	52
400	0,25	50	70
400	0,25	50	85
400	0,26	50	105
400	0,36	50	75
400	0,38	50	115
400	0,54	50	180
400	0,75	50	480
400	0,95	50	400

Auxiliary Fans

Auxiliary fans three phase

TYPE	SPEED (r/min)	MAXIMUM AIR FLOW (m ³ /h)	MAXIMUM PRESSURE (pa)	NOISE dB(A)
63	2800	45	40	62
71	2800	52	50	62
80	2800	58	60	62
90	2800	91	80	65
100	2750	142	80	67
112	2600	229	80	67
132	1400	337	35	69
160	1390	609	40	72
180	1330	686	55	72
200	1230	1679	65	72
225	1430	1786	70	74
250	1420	1813	80	75
280	1360	2415	85	78
315	1320	2820	110	81
355	900	3500	800	85

3PHASE (v)	INPUT CURRENT (A)	Hz	INPUT POWER (w)
690	0,04	50	20
690	0,05	50	25
690	0,05	50	29
690	0,05	50	32
690	0,1	50	58
690	0,1	50	69
690	0,11	50	52
690	0,14	50	70
690	0,14	50	85
690	0,15	50	105
690	0,21	50	75
690	0,22	50	115
690	0,31	50	180
690	0,43	50	480
690	0,55	50	400

Auxiliary fans single phase

TYPE	SPEED (r/min)	MAXIMUM AIR FLOW (m ³ /h)	MAXIMUM PRESSURE (pa)	NOISE dB(A)
63	2800	45	40	62
71	2800	52	50	62
80	2700	58	60	62
90	2300	91	80	65
100	2700	142	80	67
112	2400	229	80	67
132	1400	337	35	69
160	1400	609	40	72
180	1200	686	55	72
200	1200	1679	65	72
225	1400	1786	70	74
250	1400	1813	80	75
280	1400	2415	85	78

1PHASE (v)	INPUT CURRENT (A)	Hz	INPUT POWER (w)	μF
230	0,12	50	17	1
230	0,17	50	33	2
230	0,18	50	35	2
230	0,2	50	45	3
230	0,3	50	55	2
230	0,37	50	65	2
230	0,35	50	55	3
230	0,28	50	55	4
230	0,4	50	80	4
230	0,4	50	85	4
230	0,5	50	85	6
230	0,9	50	120	6
230	0,95	50	170	10

Auxiliary Fans

All frame sizes can be supplied with cooling system IC 416 (forced ventilation) on request.
In the following table shown the increases of the dimension L when a forced ventilation is mounted.

TYPE	MS SERIES (mm)	TA SERIES (mm)	TC SERIES (mm)
63	92	92	-
71	92	105	-
80	98	110	-
90	97	110	-
100	103	120	-
112	93	125	-
132	109	120	120
160	-	145	130
180	-	-	130
200	-	-	140
225	-	-	160
250	-	-	167
280	-	-	175
315	-	-	205
355	-	-	205

L standard motor+measure indicated in the table

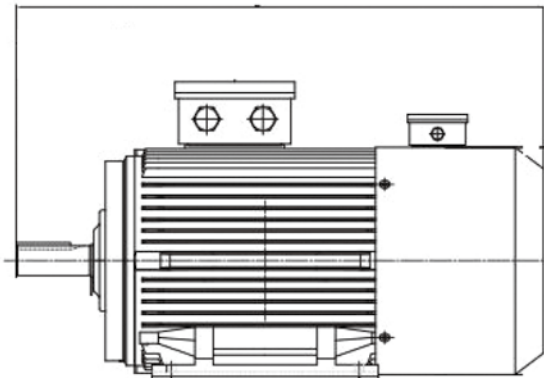

Permissible Load On The Bearings

The theoretical basic fatigue life for bearings is calculated according to the provisions of the ISO R 281-1 Standard. Life is calculated assuming that motors are running under normal ambient conditions, without abnormal vibrations, without axial or radial loads beyond the ones mentioned in the following tables and with operating temperatures of the bearings ranging between - 30 and +85 C'.

Life calculated this way is called basic life (L_{10h}) expressed in hours of operation.

50% of bearings reaches a life equal to five times the basic life resulting from the calculation.

In table 13 are mentioned the maximum permitted axial and radial loads for a basic life (L_{10h}), calculated according to the provisions of the ISO Standards, equal to 20000 and 40000 hours of operation.

Values of the radial loads are given both for loads applied to the shaft extension (X_{max}) and in correspondence of the face on the shaft hub (X_0).

Radial loads that can be applied linearly, change with the change of the application point, therefore for loads placed at a distance X from the shaft face (X_0), the maximum load that can be applied is given by the following expression:

$$F_{rX} = \frac{C_{X_0} - C_{X_{max}}}{X_{max}} \times X + C_{X_{max}}$$

Where:

F_{rX} = permitted radial load at point X

C_{X_0} = permitted radial load at point X_0

$C_{X_{max}}$ = permitted radial load at point X_{max}

X_{max} = shaft extension

X = distance from the application point of the radial load to the shaft face

To verify that the belt pull does not exceed the maximum value allowed the following formula can be used:

$$F = \frac{19100 \times P \times K}{n \times D}$$

F= radial force in Nm

P= power transmitted in KW

n= numbers of revs. per minute

D= pulley diameter in meters

K= constant

Constant values K:

2	for flat pulley with tension roller
2,25	for sheaves with V belt
2,5-3	for flat belts without tension roller, or for heavy duty with any type of pulley

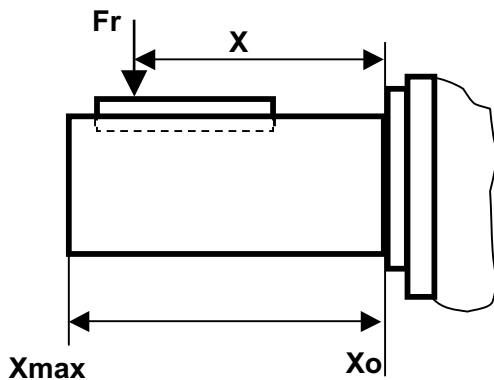

The maximum allowable radial forces, at the shaft X_{max} and at the shaft collar X_0 , reported in the following pages are for motors having the following characteristic: standard construction, horizontal mounting IMB3 or IMB35 only, operating frequency 50Hz, bearing life of 20000 or 40000 hours according to ISO 281:1990, bearing operating temperature between -20°C to +70°C, NO external axial forces, motor installed on a rigid foundation with negligible structural vibrations.

The maximum allowable axial forces, reported in the following pages are, for motors having the following characteristic:

standard construction, horizontal mounting IMB3 or IMB35 only, operating frequency 50Hz, bearing life of 20.000 or 40.000 hours according to ISO281:1990, bearing operating temperature between -20°C to +70°C, NO external radial forces, motor installed on a rigid foundation with negligible structural vibrations.

MS series permissible radial forces (N) & permissible axial forces (deep groove ball bearings)

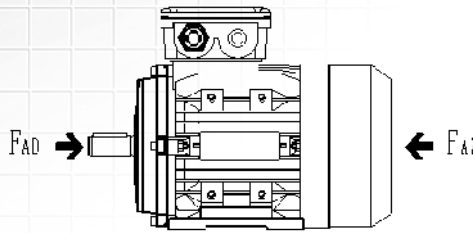
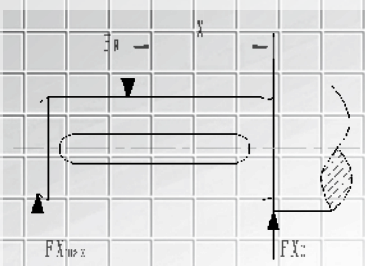

IM B3

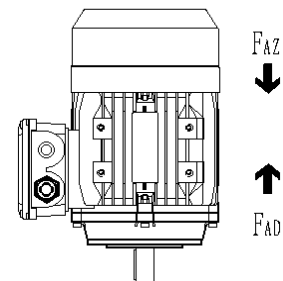

IM V1

Motor size	Poles	Shaft length (mm)	Ball bearings				Mounting IM B3				Mounting IM V1			
			Max.radial forces		Max.radial forces		Max.axial forces		Max.axial forces		Max.axial forces		Max.axial forces	
			L10=20000 hours		L10=40000 hours		L10h=20000 hours		L10h=40000 hours		L10h=20000 hours		L10h=40000 hours	
			F_{X_0}	$F_{X_{max}}$	F_{X_0}	$F_{X_{max}}$	$F_{AD}(N)$	$F_{AZ}(N)$	$F_{AD}(N)$	$F_{AZ}(N)$	$F_{AD}(N)$	$F_{AZ}(N)$	$F_{AD}(N)$	$F_{AZ}(N)$
MS56	2	20	353.8	305.7	280.2	242.1	261.0	261.0	192.6	192.6	269.3	255.9	200.8	187.5
	4	20	445.5	384.8	352.7	304.7	354.7	354.7	260.4	260.4	366.3	347.9	271.8	253.4
MS63	2	23	352.0	302.9	278.5	239.7	260.3	260.3	192.0	192.0	272.1	253.1	203.6	184.6
	4	23	442.5	380.8	349.9	301.1	353.4	353.4	259.2	259.2	371.3	343.0	276.7	248.5
	6	23	506.7	436.1	400.7	344.9	423.5	423.5	310.0	310.0	443.5	411.9	329.7	298.2
MS71	2	30	397.6	334.0	314.4	264.1	283.3	283.3	208.7	208.7	299.2	273.4	224.5	198.6
	4	30	500.2	420.2	395.3	332.1	384.6	384.6	282.0	282.0	407.3	371.1	304.4	268.2
	6	30	571.8	480.3	451.8	379.5	460.8	460.8	337.8	337.8	489.1	444.4	365.7	320.9
	8	30	631.7	530.6	499.6	419.6	520.1	520.1	384.3	384.3	544.3	505.3	408.7	369.7
MS71 (L.H.)*	2	30	400.3	340.7	316.2	269.1	282.5	282.5	208.0	208.0	302.4	270.2	227.6	195.4
	4	30	502.9	428.0	397.0	337.9	383.3	383.3	280.8	280.8	412.6	365.8	309.7	262.9
	6	30	575.1	489.4	453.8	386.2	459.2	459.2	336.3	336.3	494.9	438.6	371.5	315.1
	8	30	636.2	541.4	502.7	427.9	518.6	518.6	383.2	383.2	548.6	501.0	413.1	365.4
MS80	2	40	663.9	545.9	524.2	431.0	464.7	464.7	339.6	339.6	498.5	438.7	375.9	316.1
	4	40	836.1	687.5	660.1	542.7	629.0	629.0	462.9	462.9	677.0	600.2	507.0	430.2
	6	40	957.4	787.2	755.9	621.5	752.0	752.0	551.1	551.1	806.7	720.1	604.8	518.1
	8	40	1052.8	865.6	831.0	683.3	854.8	854.8	626.2	626.2	918.1	818.4	688.5	588.7
MS90S	2	50	726.9	574.8	574.2	454.0	495.4	495.4	362.4	362.4	532.6	472.0	398.9	338.3
	4	50	919.1	726.8	726.6	574.6	671.9	671.9	495.3	495.3	710.3	648.4	533.2	471.4
	6	50	1048.8	829.4	828.5	655.2	801.5	801.5	587.5	587.5	855.0	769.7	640.2	554.9
	8	50	1156.3	914.4	913.8	722.7	912.8	912.8	669.1	669.1	966.7	881.4	722.0	636.7
MS90L	2	50	732.6	593.9	577.7	468.3	493.1	493.1	360.3	360.3	542.7	461.8	409.0	328.1
	4	50	925.9	750.5	730.7	592.3	668.6	668.6	492.1	492.1	724.2	634.6	547.1	457.5
	6	50	1057.4	857.1	834.0	676.0	798.0	798.0	584.3	584.3	869.0	755.6	654.2	540.9
	8	50	1166.4	945.5	920.5	746.1	909.1	909.1	665.8	665.8	980.7	867.3	736.0	622.7
MS90L(L.H.)*	2	50	737.5	612.1	580.6	481.9	490.8	490.8	358.2	358.2	552.9	451.7	419.2	318.0
	4	50	935.5	776.4	737.8	612.3	667.4	667.4	490.9	490.9	729.4	629.3	552.3	452.3
	6	50	1064.3	883.3	837.9	695.4	794.2	794.2	580.7	580.7	884.0	740.6	669.3	525.8
	8	50	1181.6	980.6	932.5	773.9	909.1	909.1	665.8	665.8	980.7	867.3	736.0	622.7
MS100L	2	60	1012.5	805.5	797.4	634.4	673.3	673.3	492.5	492.5	755.6	621.2	573.1	438.7
	4	60	1276.1	1015.2	1005.0	799.6	912.3	912.3	669.6	669.6	1015.9	848.3	772.2	604.6
	6	60	1458.0	1159.9	1147.7	913.1	1091.3	1091.3	801.1	801.1	1216.7	1012.5	921.6	717.3
	8	60	1621.6	1290.1	1280.1	1018.4	1247.1	1247.1	914.4	914.4	1341.3	1191.6	1007.0	857.2

Motor size	Poles	Shaft length (mm)	Ball bearings				Mounting IM B3				Mounting IM V1			
			Max.radial forces		Max.radial forces		Max.axial forces		Max.axial forces		Max.axial forces		Max.axial forces	
			L10=20000 hours		L10=40000 hours		L10h=20000 hours		L10h=40000 hours		L10h=20000 hours		L10h=40000 hours	
			FX ₀	FX _{max}	FX ₀	FX _{max}	F _{AD} (N)	F _{AZ} (N)	F _{AD} (N)	F _{AZ} (N)	F _{AD} (N)	F _{AZ} (N)	F _{AD} (N)	F _{AZ} (N)
MS100(L.H.)*	2	60	1020.4	823.9	803.6	648.8	673.3	673.3	492.5	492.5	755.6	621.2	573.1	438.7
	4	60	1276.1	1030.3	1002.9	809.7	907.1	907.1	664.8	664.8	1037.8	826.3	794.1	582.6
	6	60	1469.4	1186.3	1156.7	933.9	1091.3	1091.3	801.1	801.1	1216.7	1012.5	921.6	717.3
	8	60	1634.3	1319.5	1290.1	1041.6	1247.1	1247.1	914.4	914.4	1341.3	1191.6	1007.0	857.2
MS112M	2	60	1401.5	1131.5	1104.6	891.8	669.6	949.5	489.1	693.5	772.5	884.6	590.0	626.8
	4	60	1767.0	1426.7	1392.9	1124.6	907.8	1285.4	665.3	945.2	1035.2	1207.0	791.5	865.5
	6	60	2018.7	1629.8	1590.4	1284.1	1085.1	1534.4	795.6	1122.6	1241.7	1439.5	946.5	1025.3
	8	60	2241.4	1809.7	1770.1	1429.1	1241.5	1756.6	909.4	1287.0	1362.7	1685.7	1028.4	1213.9
MS112(L.E.S.)*	2	60	1407.5	1144.8	1109.3	902.3	669.6	949.5	489.1	693.5	772.5	884.6	590.0	626.8
	4	60	1764.4	1435.1	1388.7	1129.5	901.5	1279.9	660.3	940.1	1058.0	1184.3	814.3	842.8
	6	60	2027.4	1649.0	1597.3	1299.2	1085.1	1534.4	795.6	1122.6	1241.7	1439.5	946.5	1025.3
	8	60	2251.1	1831.0	1777.7	1446.0	1241.5	1756.6	909.4	1287.0	1362.7	1685.7	1028.4	1213.9
MS132S	2	80	2092.6	1597.3	1650.4	1259.8	1003.8	1415.8	756.4	1036.3	1144.1	1326.7	872.5	944.5
	4	80	2635.5	2011.7	2078.3	1586.4	1358.2	1917.0	996.7	1408.6	1540.2	1804.6	1176.4	1294.4
	6	80	3025.7	2309.6	2388.0	1822.8	1633.5	2301.5	1199.9	1681.9	1818.7	2184.5	1382.5	1567.5
	8	80	3340.3	2549.7	2638.3	2013.9	1857.8	2615.6	1359.7	1918.5	2034.5	2511.3	1533.8	1811.0
MS132M	2	80	2110.4	1661.4	1660.8	1307.5	995.5	1407.4	749.0	1028.8	1181.7	1289.0	910.1	906.9
	4	80	2658.4	2092.8	2092.1	1646.9	1347.4	1906.2	986.6	1398.3	1586.2	1758.6	1222.4	1248.3
	6	80	3036.1	2390.1	2387.8	1879.7	1610.0	2279.5	1179.8	1672.2	1907.1	2096.1	1470.9	1479.1
	8	80	3377.4	2658.8	2663.8	2097.0	1847.5	2605.1	1350.2	1909.0	2075.0	2470.8	1574.3	1770.5
MS132L	2	80	2108.4	1688.8	1654.8	1325.5	985.4	1397.2	739.8	1019.6	1227.7	1243.1	956.1	860.9
	4	80	2650.8	2123.3	2079.4	1665.6	1331.3	1888.0	971.5	1383.0	1655.3	1689.6	1291.4	1179.3
	6	80	3038.6	2433.9	2384.4	1909.9	1596.8	2266.0	1167.4	1660.2	1961.5	2041.7	1525.3	1424.8
	8	80	3407.6	2729.5	2687.6	2152.8	1847.5	2605.1	1350.2	1909.0	2075.0	2470.8	1574.3	1770.5
MS160M	2	110	2737.7	2156.9	2150.9	1694.6	1798.2	1798.2	1314.3	1314.3	2085.7	1615.1	1596.5	1125.9
	4	110	3458.5	2724.8	2719.1	2142.3	2438.7	2438.7	1789.1	1789.1	2783.1	2230.5	2126.7	1574.1
	6	110	3970.1	3127.8	3123.7	2461.0	2930.2	2930.2	2151.2	2151.2	3294.4	2710.9	2509.3	1925.8
	8	110	4383.0	3453.2	3451.5	2719.2	3329.7	3329.7	2435.1	2435.1	3696.2	3112.8	2798.5	2215.1
MS160L	2	110	2715.9	2139.7	2129.1	1677.4	1787.6	1787.6	1304.6	1304.6	2133.8	1567.0	1644.6	1077.8
	4	110	3382.3	2664.8	2643.0	2082.3	2399.2	2399.2	1752.2	1752.2	2950.8	2062.9	2294.3	1406.4
	6	110	3871.2	3049.9	3024.8	2383.1	2876.2	2876.2	2101.4	2101.4	3512.3	2493.0	2727.2	1707.9
	8	110	4338.0	3417.7	3406.5	2683.8	3304.4	3304.4	2411.7	2411.7	3795.2	3013.8	2897.6	2116.1
MS180M	2	110	3745.1	3052.2	2939.7	2395.7	1383.0	2396.2	1035.7	1805.5	1801.5	2125.8	1451.9	1529.8
	4	110	4720.0	3846.7	3705.2	3019.6	1885.8	3245.3	1365.1	2377.4	2417.5	2913.3	1888.3	2039.0
	6	110	5372.4	4378.3	4210.7	3431.6	2227.6	3871.9	1620.1	2836.4	2924.8	3445.7	2307.0	2402.7
	8	110	5932.4	4834.7	4653.8	3792.7	2542.5	4403.8	1853.0	3212.0	3262.8	3972.2	2561.3	2769.5
MS200L	2	110	4212.9	3448.1	3295.6	2697.4	1496.9	2706.9	1114.8	2035.2	2112.3	2307.8	1727.2	1629.6
	4	110	5323.9	4357.5	4168.2	3411.6	2046.6	3674.0	1477.0	2686.0	2792.1	3207.3	2209.8	2210.3
	6	110	6061.6	4961.3	4738.6	3878.5	2418.4	4384.8	1751.9	3205.1	3368.4	3802.7	2687.3	2612.9
	8	110	6653.3	5445.6	5197.1	4253.8	2740.7	4977.3	1984.1	3632.2	3840.8	4301.7	3068.8	2930.7

Note:
FR=FX₀-X/E(FX₀-FX_{max})
When the motor is running at 60Hz, the permissible force will reduce 10%.
(L.H.)* = Long housing
(L.E.S.)* = Long End Shield

TA series permissible radial forces (N) & permissible axial forces (deep groove ball bearings)

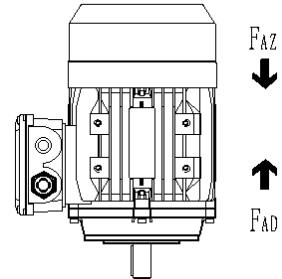
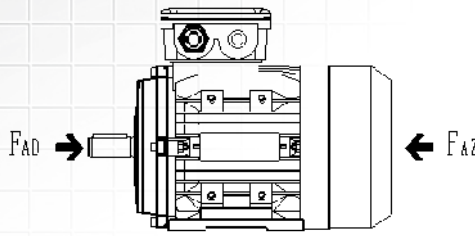
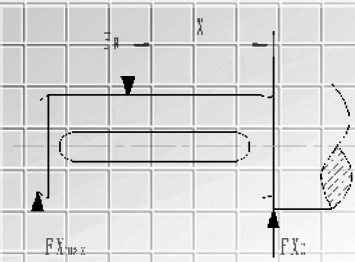

IM B3

IM V1

Motor size	Poles	Shaft length (mm)	Ball bearings				Mounting IM B3				Mounting IM V1			
			Max.radial forces		Max.radial forces		Max.axial forces		Max.axial forces		Max.axial forces		Max.axial forces	
			L10=20000 hours		L10=40000 hours		L10h=20000 hours		L10h=40000 hours		L10h=20000 hours		(L10h=40000 hours)	
			F_{Rx}	F_{Rmax}	F_{Rx}	F_{Rmax}	$F_{AD}(N)$	$F_{AZ}(N)$	$F_{AD}(N)$	$F_{AZ}(N)$	$F_{AD}(N)$	$F_{AZ}(N)$	$F_{AD}(N)$	$F_{AZ}(N)$
TA56	2	20	351.1	303.6	278.0	240.5	261.0	261.0	192.6	192.6	269.3	255.9	200.8	187.5
	4	20	442.0	382.2	350.0	302.7	354.7	354.7	260.4	260.4	366.3	347.9	271.8	253.4
TA63	2	23	352.6	304.1	279.0	240.6	260.3	260.3	192.0	192.0	272.1	253.1	203.6	184.6
	4	23	443.3	382.3	350.6	302.3	353.4	353.4	259.2	259.2	371.3	343.0	276.7	248.5
TA71	6	23	507.6	437.7	401.5	346.2	423.5	423.5	310.0	310.0	443.5	411.9	329.7	298.2
	2	30	391.9	330.5	309.6	261.1	282.5	282.5	208.0	208.0	302.4	270.2	227.6	195.4
	4	30	492.4	415.3	388.7	327.8	383.3	383.3	280.8	280.8	412.6	365.8	309.7	282.9
	6	30	563.1	474.9	444.4	374.7	459.2	459.2	336.3	336.3	494.9	438.6	371.5	315.1
	8	30	622.9	525.3	492.2	415.1	518.6	518.6	383.2	383.2	548.6	501.0	413.1	365.4
	2	40	657.9	538.3	519.6	425.1	464.9	464.9	339.8	339.8	497.6	439.6	375.0	317.0
TA80	4	40	828.8	678.1	654.5	535.5	629.5	629.5	463.1	463.1	675.3	601.9	505.3	431.9
	6	40	949.3	776.7	749.7	613.4	752.7	752.7	551.7	551.7	804.2	722.6	602.3	520.6
	8	40	1048.8	858.1	829.2	678.4	858.6	858.6	629.6	629.6	904.1	832.3	674.5	602.7
TA90S	2	50	720.1	571.0	568.4	450.7	494.6	494.6	361.6	361.6	536.2	468.3	402.5	334.6
	4	50	910.2	721.8	719.1	570.3	670.7	670.7	494.1	494.1	715.3	643.4	538.3	466.3
	6	50	1041.0	825.5	822.3	652.0	801.3	801.3	587.4	587.4	855.6	769.0	640.8	554.3
TA90L	8	50	1147.7	910.1	907.0	719.2	912.6	912.6	669.0	669.0	967.3	880.7	722.7	636.1
	2	50	721.7	586.3	567.8	461.3	490.0	490.0	357.5	357.5	556.5	448.1	422.8	314.4
	4	50	911.0	740.1	717.1	582.6	663.9	663.9	487.6	487.6	743.9	614.8	566.8	437.7
	6	50	1042.8	847.2	820.8	666.8	793.6	793.6	580.2	580.2	866.3	738.4	671.5	523.6
TA100L	8	50	1154.9	938.2	910.5	739.7	906.7	906.7	663.6	663.6	989.6	858.4	745.0	613.8
	2	60	1007.5	808.7	791.9	635.6	669.7	669.7	489.2	489.2	772.1	604.7	589.6	422.3
	4	60	1266.7	1016.7	995.0	798.6	904.9	904.9	663.5	663.5	1043.5	820.7	799.8	577.0
TA112M	6	60	1464.8	1175.7	1153.8	926.0	1093.1	1093.1	802.8	802.8	1209.5	1019.8	914.3	724.6
	8	60	1613.1	1294.7	1270.8	1020.0	1239.9	1239.9	907.9	907.9	1368.9	1164.0	1034.5	829.7
	2	60	1396.9	1130.8	1098.8	889.5	664.7	944.6	484.8	689.1	794.3	862.7	611.8	604.9
TA132S	4	60	1760.2	1425.0	1384.8	1121.0	899.8	1278.3	658.8	938.5	1064.8	1177.4	821.1	835.9
	6	60	2030.7	1643.9	1600.9	1296.0	1087.6	1536.9	797.9	1124.9	1231.6	1449.5	936.4	1035.4
	8	60	2251.7	1822.8	1778.6	1439.8	1242.6	1757.7	910.4	1288.0	1358.5	1689.9	1024.2	1218.1
TA132M	2	80	2129.9	1668.2	1679.9	1315.7	1003.9	1415.9	756.5	1036.4	1143.8	1327.0	872.2	944.8
	4	80	2684.1	2102.2	2117.0	1658.1	1359.2	1918.0	997.6	1409.5	1536.2	1808.6	1172.4	1298.4
	6	80	3085.2	2416.3	2436.1	1907.9	1636.6	2304.7	1202.8	1684.8	1806.1	2197.1	1369.9	1580.2
TA160M	8	80	3398.6	2661.7	2684.1	2102.2	1857.2	2615.0	1359.2	1918.0	2036.8	2509.1	1536.1	1808.8
	2	80	2112.4	1697.2	1656.6	1331.0	982.4	1394.1	737.0	1016.9	1241.5	1229.2	969.9	847.1
	4	80	2665.1	2141.3	2090.9	1679.9	1331.9	1888.7	972.1	1383.6	1652.5	1692.3	1288.7	1182.1
TA160L	6	80	3061.3	2459.6	2404.0	1931.4	1601.0	2270.3	1171.3	1664.2	1944.3	2058.9	1508.1	1442.0
	8	80	3425.1	2751.9	2701.6	2170.6	1847.9	2605.6	1350.6	1909.4	2073.2	2472.6	1572.5	1772.3
	2	110	2687.3	2088.3	2111.1	1640.6	1024.2	1797.7	768.2	1313.9	1312.2	1613.1	1054.0	1123.9
	4	110	3403.7	2645.0	2677.7	2080.8	1405.7	2442.8	1019.6	1792.9	1714.6	2247.9	1333.9	1591.4
TA180M	6	110	3914.5	3042.0	3083.5	2396.2	1683.1	2939.2	1231.5	2159.5	1999.6	2747.2	1544.7	1962.1
	8	110	4320.0	3357.1	3405.3	2646.2	1920.2	3338.9	1406.5	2443.6	2239.3	3149.0	1711.1	2251.4
	2	110	2682.8	2133.7	2099.3	1669.7	1006.3	1779.1	751.0	1335.9	1396.8	1528.5	1138.5	1039.4
	4	110	3349.3	2663.9	2614.3	2079.2	1356.6	2392.2	974.6	1745.8	1929.2	2033.3	1548.5	1376.8
TA200L	6	110	3925.0	3121.7	3083.5	2452.5	1662.9	2918.1	1212.4	2140.0	2084.7	2662.0	1629.8	1877.0
	8	110	4340.3	3452.0	3414.1	2715.4	1901.7	3319.9	1389.4	2426.0	2313.8	3074.5	1785.7	2176.8
	2	110	3745.1	3052.2	2939.7	2395.7	1383.0	2396.2	1035.7	1805.5	1801.5	2125.8	1451.9	1529.8
TA200L	4	110	4720.0	3846.7	3705.2	3019.6	1885.8	3245.3	1365.1	2377.4	2417.5	2913.3	1888.3	2039.0
	6	110	5372.4	4378.3	4210.7	3431.6	2227.6	3871.9	1620.1	2836.4	2924.8	3445.7	2307.0	2402.7
	8	110	5932.4	4834.7	4653.8	3792.7	2542.5	4403.8	1853.0	3212.0	3262.8	3972.2	2561.3	2769.5
	2	110	4212.9	3448.1	3295.6	2697.4	1496.9	2706.9	1114.8	2035.2	2112.3	2307.8	1727.2	1629.6
TA200L	4	110	5323.9	4357.5	4168.2	3411.6	2046.6	3674.0	1477.0	2686.0	2792.1	3207.3	2209.8	2210.3
	6	110	6061.6	4961.3	4738.6	3878.5	2418.4	4384.8	1751.9	3205.1	3368.4	3802.7	2687.3	2612.9
	8	110	6653.3	5445.6	5197.1	4253.8	2740.7	4977.3	1984.1	3632.2	3840.8	4301.7	3068.8	2930.7

TC series permissible radial forces (N)

Motor size	Poles	Shaft length mm	Ball bearings				Roller bearings			
			L10=20000 hours		L10=40000 hours		L10=20000 hours		L10=40000 hours	
			X_0	X_{max}	X_0	X_{max}	X_0	X_{max}	X_0	X_{max}
80	2	40	660	540	520	420				
	4		830	680	650	630				
	6		950	760	750	610				
	8		1050	860	830	680				
90	2	50	720	570	570	450				
	4		910	720	720	570				
	6		1040	820	820	650				
	8		1050	910	900	710				
100	2	60	100	800	790	630				
	4		1200	1000	990	800				
	6		1460	1180	1150	930				
	8		1600	1300	1270	1020				
112	2	60	1400	1130	1100	890				
	4		1760	1420	1380	1120				
	6		2030	1640	1600	1300				
	8		2250	1820	1800	1440				
132	2	80	2130	1660	1600	1300				
	4		2600	2100	2100	1660				
	6		3080	2400	2400	1900				
	8		3400	2600	2680	2100				
160	2	110	2680	2130	2100	1670	5900	4200	4800	4200
	4		3350	2660	2610	2080	6800	4200	5800	4200
	6		3900	3100	3050	2450	8200	4200	6800	4200
	8		4300	3360	3400	2650	8600	4200	7500	4200
180	2	110	3800	3050	3100	2400	7700	5300	6700	5300
	4		4100	3380	3450	2820	8500	5300	7200	5300
	6		4300	3450	3500	2880	8800	5300	7400	5300
	8		4500	3600	3650	2950	9200	5300	8200	5300
200	2	110	5000	4180	4200	3500	10200	8600	8900	7300
	4		5400	4500	4430	3680	11600	9500	9800	8200
	6		5800	4880	4750	4000	12500	9500	10600	8800
	8		6300	5200	5240	4370	13000	9500	11000	9300
225S	2	110	6410	5400	5400	4500	13300	10700	11500	9700
	4	140	7300	5900	6100	4900	15300	10200	13200	10200
	6		7600	6200	6300	5100	16400	10200	14000	10200
	8		8500	6800	7100	5700	17800	10200	15200	10200

TC series permissible radial forces (N)

Motor size	Poles	Shaft length mm	Ball bearings				Roller bearings			
			L10=20000 hours		L10=40000 hours		L10=20000 hours		L10=40000 hours	
			X_0	X_{max}	X_0	X_{max}	X_0	X_{max}	X_0	X_{max}
225M	2	110	6100	5100	5100	4300	13000	10600	11200	9500
	4	140	7000	5700	5800	4700	15100	10200	12800	10200
	6		7100	5750	5850	4700	16000	10200	13400	10200
	8		8000	6400	6600	5300	17300	10200	14600	10200
250M	2	140	6800	5500	5600	4600	16300	10800	14000	10800
	4		7400	6000	6000	4900	18000	13800	15300	12000
	6		8200	6600	6600	5400	20200	13800	17200	13800
	8		9500	7700	7800	6300	22600	13800	19200	13800
280S	2	140	7200	5800	5800	4700	16000	10200	13400	10200
	4		8000	6500	6600	5400	22000	14000	15400	13200
	6		10000	8500	8600	7300	27000	14400	23000	14000
	8		10500	8800	8800	7600	29000	14400	23000	14000
280M	2	140	7000	5600	5600	4500	15800	10000	13200	10000
	4		7800	6300	6400	5300	21500	14000	15200	13200
	6		9800	8300	8400	7200	26500	14400	22800	14000
	8		10300	8600	8600	7300	28600	14400	23000	14000
315S	2	140	7500	6100	6000	5000	20500	13600	15000	13000
	4	170	9000	7000	7100	5700	29000	15000	23000	15000
	6		11000	9200	9300	8000	34000	15000	25000	15000
	8		13000	10500	10600	9200	37000	15000	26000	15000
315M/L	2	140	7400	6000	6000	4900	20300	13600	14800	13000
	4	170	8900	6900	7000	5600	28600	15000	22800	15000
	6		10500	9100	9200	7900	33800	15000	24700	15000
	8		12800	10200	10300	9000	36800	15000	25800	15000
355M	2	140	7600	6100	6200	5100	23000	13600	18000	13600
	4	210	12300	9300	9400	8300	46000	23000	36000	23000
	6		14600	11000	11100	10000	52000	23000	42000	23000
	8		16400	12000	12200	11000	56000	23000	46000	23000
355L	2	140	7300	6100	6200	5100	23000	13600	18000	13600
	4	210	12000	9100	9200	8200	45500	23000	35500	23000
	6		14100	10800	10900	9900	51300	23000	41200	23000
	8		16000	11600	11800	10800	56000	23000	46000	23000

TC series permissible axial forces(deep groove ball bearings)

Motor size	Poles	Shaft length (mm)	Mounting IM B3				Mounting IM V1			
			L10h=20000 hours		L10h=40000 hours		L10h=20000 hours		L10h=40000 hours	
			F _{AD} (N)	F _{AZ} (N)	F _{AD} (N)	F _{AZ} (N)	F _{AD} (N)	F _{AZ} (N)	F _{AD} (N)	F _{AZ} (N)
80	2	40	260	420	190	305	270	400	200	288
	4		350	560	250	400	360	530	270	380
	6		450	700	330	500	460	670	345	480
	8		550	830	400	600	560	800	420	570
90	2	50	370	430	270	310	380	400	285	280
	4		510	590	370	430	530	550	400	395
	6		630	710	460	510	640	670	460	480
	8		760	860	555	620	780	820	580	590
100	2	60	370	590	270	430	380	550	280	400
	4		500	810	365	590	520	750	390	540
	6		650	1020	475	450	680	950	510	680
	8		780	1190	570	860	810	1120	600	800
112	2	60	540	1140	395	830	560	1080	420	770
	4		730	1550	530	1130	760	1470	570	1000
	6		960	1940	700	1400	990	1860	740	1300
	8		1070	2150	780	1500	1100	2050	820	1400
132	2	80	720	1320	520	960	760	1210	570	870
	4		990	1810	720	1300	1030	1660	770	1200
	6		1220	2200	890	1600	1270	2050	950	1500
	8		1370	2450	1000	1780	1440	2250	1000	1600
160	2	110	2600	2600	2100	2100	2900	2392	2300	1900
	4		3200	3200	2600	2600	3500	2900	2800	2300
	6		3500	3500	2800	2800	3800	3200	3000	2500
	8		4000	4000	3200	3200	4400	3700	3500	3000
180	2	110	3200	3200	2560	2560	3500	3000	2800	2400
	4		3600	3600	2880	2880	4000	3300	3200	2600
	6		4100	4100	3280	3280	4500	3700	3600	3000
	8		4200	4200	3360	3360	4600	3800	3650	3000
200	2	110	3600	3600	2880	2880	4000	3300	3200	2600
	4		4400	4400	3520	3520	4800	4000	3800	3200
	6		5000	5000	4000	4000	5500	4600	4400	3600
	8		6000	6000	4800	4800	6600	5500	5300	4400
225S	2	110	4000	4000	3200	3200	4400	3700	3500	3000
	4	140	5000	5000	4000	4000	5500	4600	4400	3700
	6		5500	5500	4400	4400	6000	5000	4800	4000
	8		6200	6200	4960	4960	6800	5700	5400	4500
225M	2	110	3900	3900	3120	3120	4300	3600	3400	2900
	4	140	4900	4900	3920	3920	5400	4500	4300	3600
	6		5300	5300	4240	4240	5800	4900	4600	3900
	8		6000	6000	4800	4800	6600	5500	5300	4400
250M	2	140	4300	4300	3400	3400	4800	4000	3800	3200
	4		5500	5500	4400	4400	6000	5000	4800	4000
	6		6000	6000	4800	4800	6600	5500	5200	4400
	8		6900	6900	5500	5500	8600	6300	6800	5000

TC series permissible axial forces(deep groove ball bearings)

Motor size	Poles	Shaft length (mm)	Mounting IM B3				Mounting IM V1			
			L10h=20000 hours		L10h=40000 hours		L10h=20000 hours		L10h=40000 hours	
			$F_{AD}(N)$	$F_{AZ}(N)$	$F_{AD}(N)$	$F_{AZ}(N)$	$F_{AD}(N)$	$F_{AZ}(N)$	$F_{AD}(N)$	$F_{AZ}(N)$
280S	2	140	4200	4200	3350	3350	4600	3800	3700	3000
	4		6000	6000	4800	4800	6600	5500	5300	4400
	6		7200	7200	5700	5700	7900	6600	6300	5300
	8		8000	8000	6400	6400	8800	7300	7000	5800
280M	2	140	4100	4100	3200	3200	4500	3700	3600	3000
	4		5900	5900	4700	4700	6500	5400	5200	4300
	6		7050	7050	5600	5600	7700	6400	6200	5100
	8		7800	7800	6200	6200	8500	7200	6800	5700
315S	2	140	6100	4200	4800	2850	7900	2600	6600	1300
	4	170	8400	6400	6400	4500	10400	4800	8400	2900
	6		9800	7800	7500	5500	12200	5650	9800	3300
	8		11000	9000	8400	6300	14000	7200	11300	4500
315M/L	2	140	6000	4100	4700	2800	7800	2500	6400	1200
	4	170	8200	6200	6200	4400	10200	4700	8200	2800
	6		9400	7400	7100	5100	12200	5500	9600	3200
	8		10400	8500	7900	5600	13600	7000	11000	4400
355M	2	140	4100	3200	2200	2500	9600	5000	7700	3100
	4	210	7700	6800	6000	4800	10200	6600	8100	4500
	6		9400	7800	6300	5500	11600	6700	9000	4400
	8		11000	8600	6600	6000	11900	7700	9600	5500
355L	2	140	3900	3000	2100	2400	9500	4900	7600	3000
	4	210	7500	6600	5900	4700	10100	6500	8000	4400
	6		9200	7700	6200	5400	11500	6600	8900	4300
	8		10800	8500	6500	5900	11800	7600	9500	5400

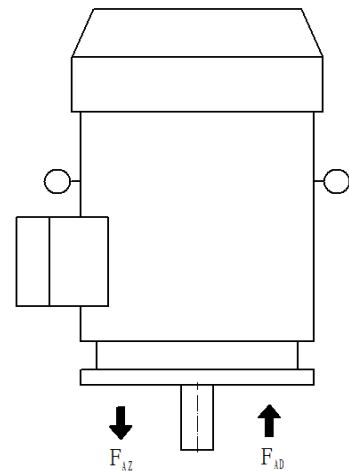
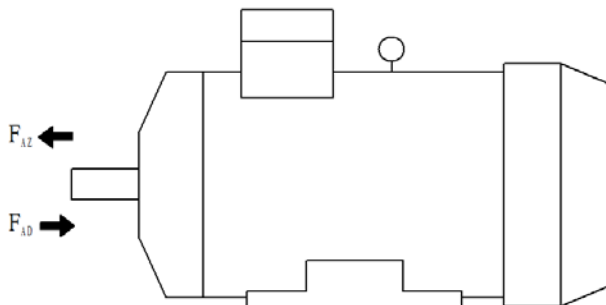

Motor Spare Part List "Exploded Drawing"

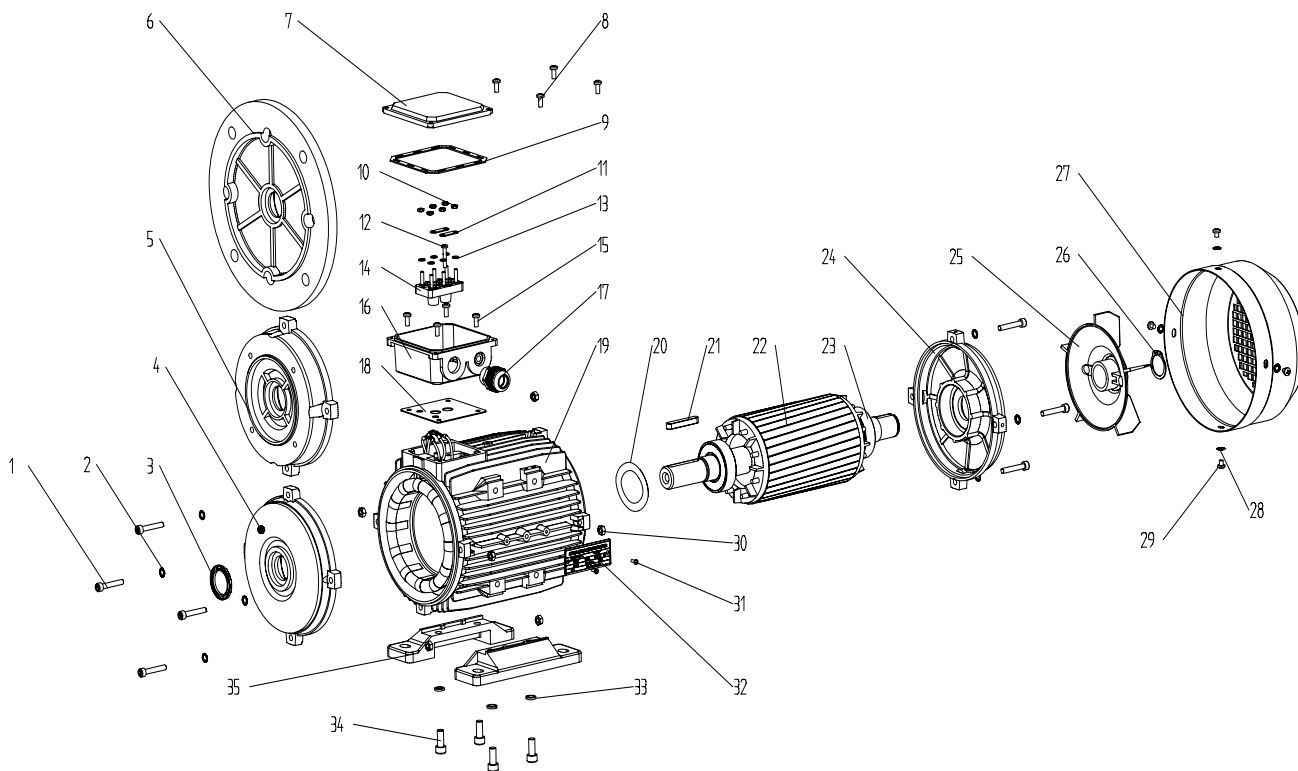

This catalogue is only a reference for users.
The concrete data be changed please contact with us before ordering.

- | | | |
|-------------------------------|----------------------|-----------------------------|
| 1. Screw | 13. Terminal shim | 25. Cooling fan |
| 2. Gasket | 14. Terminal board | 26. Fan circlip |
| 3. Oil seal | 15. TB fixing screws | 27. Fan cover |
| 4. Front endshield | 16. TB base | 28. Fan cover fixing shim |
| 5. B14 flange | 17. Cable gland | 29. Fan cover fixing screws |
| 6. B5 flange | 18. TB bottomgasket | 30. Endshield fixing nut |
| 7. TB cover | 19. Frame | 31. Rivet |
| 8. TB fixing screws | 20. Preload washer | 32. Nameplate |
| 9. TB upper gasket | 21. Key | 33. Foot fixing nut |
| 10. Terminal board fixing nut | 22. Rotor | 34. Foot fixing screws |
| 11. Terminal bridge | 23. Bearing | 35. Foot |
| 12. Terminal pin | 24. NDE endshield | |

MS/MSD Series Dimensional Drawings

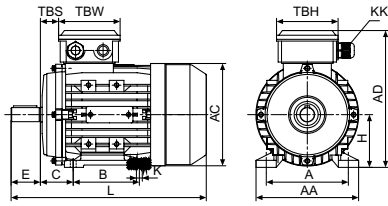

56-160 IM B3

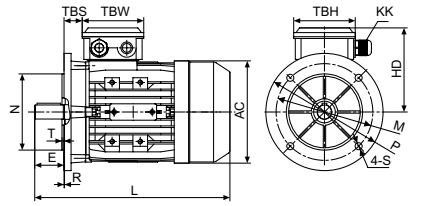

56-160 IM B5

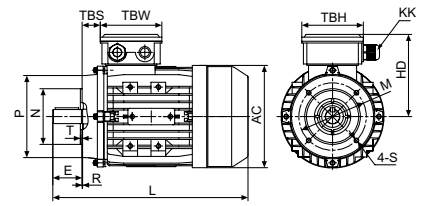

56-160 IM B14

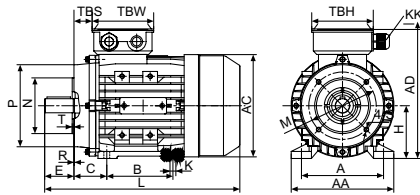

56-160 IM B34

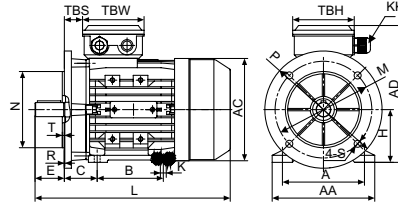

56-160 IM B35

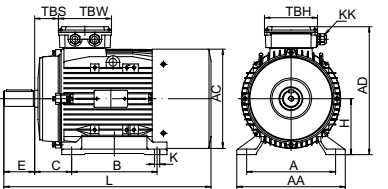
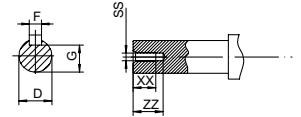

180-200 IM B3

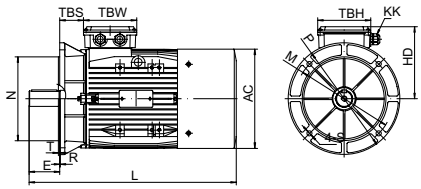

180-200 IM B5

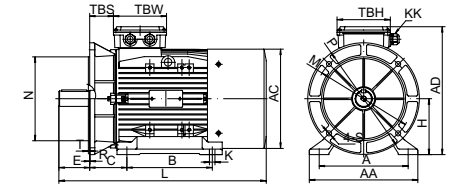

180-200 IM B35

Overall & Installation Dimensions

FRAME	Foot Mounting					Shaft							General							
	H	A	B	C	D	E	F	G	K	SS	XX	ZZ	AA	AD	HD	AC	L	TBS	TBW	TBH
56	56	90	71	36	Φ9	20	3	7.2	5.8*8.8	M4	10	14	110	152	96	Φ110	196	14	88	88
63	63	100	80	40	Φ11	23	4	8.5	7*10	M4	10	14	120	169	106	Φ121	220	14	94	94
71 ^{**}	71	112	90	45	Φ14	30	5	11	7*10	M5	12	17	132	184	113	Φ139	241(255)	20	94	94
80	80	125	100	50	Φ19	40	6	15.5	10*13	M6	16	21	160	211	131	Φ156	290	27	105	105
90S	90	140	100	56	Φ24	50	8	20	10*13	M8	19	25	175	228	138	Φ175	312	30	105	105
90L1/L2	90	140	125	56	Φ24	50	8	20	10*13	M8	19	25	175	228	138	Φ175	337/367	30	105	105
100 ^{**}	100	160	140	63	Φ28	60	8	24	12*15	M10	22	30	198	248	148	Φ196	368(386)	26	105	105
112	112	190	140	70	Φ28	60	8	24	12*15	M10	22	30	220	278	166	Φ221	397	32	112	112
132S	132	216	140	89	Φ38	80	10	33	12*15	M12	28	37	252	316	184	Φ256	437	38	112	112
132M/L	132	216	178	89	Φ38	80	10	33	12*15	M12	28	37	252	316	184	Φ256	475/501	38	112	112
160M/L	160	254	210/254	108	Φ42	110	12	37	15*19	M16	36	45	290	382	222	Φ313	641	64	143	143
180M/L	180	279	241/279	121	Φ48	110	14	42.5	15*25	M16	36	45	340	440	260	Φ355	730	73	190	190
200L	200	318	305	133	Φ55	110	16	49	19*29	M20	42	53	390	460	260	Φ355	745	85	190	190

FRAME	KK	B5						B14						B5R						B14B						
		N	M	P	S	T	R	N	M	P	S	T	R	N	M	P	T	S	R	N	M	P	T	S	R	
56	1-M16*1.5	Φ80	Φ100	Φ120	Φ7	3	0	Φ50	Φ65	Φ80	M5	2.5	0													
63	1-M16*1.5	Φ95	Φ115	Φ140	Φ10	3	0	Φ60	Φ75	Φ90	M5	2.5	0													
71	1-M20*1.5	Φ110	Φ130	Φ160	Φ10	3.5	0	Φ70	Φ85	Φ105	M6	2.5	0	Φ95	Φ115	Φ140	3	Φ10	0	Φ95	Φ115	Φ140	3	M8	0	
80	1-M20*1.5	Φ130	Φ165	Φ200	Φ12	3.5	0	Φ80	Φ100	Φ120	M6	3	0	Φ110	Φ130	Φ160	3.5	Φ10	0	Φ110	Φ130	Φ160	3.5	M8	0	
90	1-M20*1.5	Φ130	Φ165	Φ200	Φ12	3.5	0	Φ95	Φ115	Φ140	M8	3	0	Φ110	Φ130	Φ160	3.5	Φ10	0	Φ110	Φ130	Φ160	3.5	M8	0	
100	2-M20*1.5	Φ180	Φ215	Φ250	Φ15	4	0	Φ110	Φ130	Φ160	M8	3.5	0	Φ130	Φ165	Φ200	3.5	Φ12	0	Φ130	Φ165	Φ200	3.5	M10	0	
112	2-M25*1.5	Φ180	Φ215	Φ250	Φ15	4	0	Φ110	Φ130	Φ160	M8	3.5	0	Φ130	Φ165	Φ200	3.5	Φ12	0	Φ130	Φ165	Φ200	3.5	M10	0	
132	2-M25*1.5	Φ230	Φ265	Φ300	Φ15	4	0	Φ130	Φ165	Φ200	M10	3.5	0	Φ180	Φ215	Φ250	4	Φ15	0	Φ180	Φ215	Φ250	4	M12	0	
160	2-M32*1.5	Φ250	Φ300	Φ350	Φ19	5	0	Φ180	Φ215	Φ250	M12	4	0													
180	2-M32*1.5	Φ250	Φ300	Φ350	Φ19	5	0																			
200	2-M40*1.5	Φ300	Φ350	Φ400	Φ19	5	0																			

** This frame size has two housing sizes, the rated output is for normal "L" size, and increased output is for the bigger "L" size (refer to the figures in the bracket "()")