



METALLUX

Swiss technology at your service

ME75x/MEP75x datasheet

MONOLITHIC PIEZORESISTIVE CERAMIC PRESSURE TRANSDUCER

Metallux ME75x and MEP75x are monolithic pressure sensors made with ceramic cell and work following the piezoresistive principle. The Wheatstone bridge is screen printed directly on one side of the ceramic diaphragm by means of Thick-Film technology and signal conditioning electronics are added to generate 0.5...4.5 V ratiometric output (ME750), current loop 4...20 mA (ME751) or 0...10 V non ratiometric output (ME752). Also available in customized version I²C output.

Pressure and temperature calibration are done electronically with the on-board ASIC and can be performed in bar (ME75x) or in psi (MEP75x). Electronics provide offset and span correction when temperature changes. Aging detection is constantly performed. This new method guarantees good precision and long-term stability.

The Metallux ME75x family meets EMC requirements. The ASIC stores production lot specific data for sensor traceability and allows custom calibration.

Due to the excellent chemical immunity of the the Al₂O₃ ceramic, the ME75x sensors are suitable for nearly all aggressive media.

FEATURES

Excellent resistance to corrosion and abrasion

Signal conditioning

EMC compliant

Thermally compensated

Zero stress mounting software

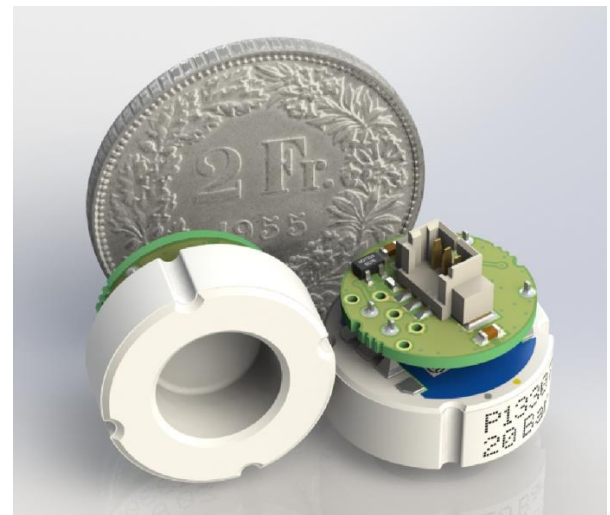
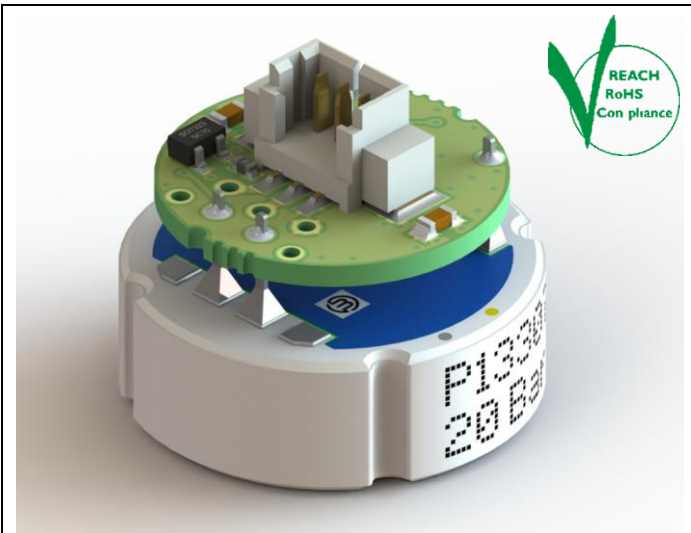

Pressure sensors family tree

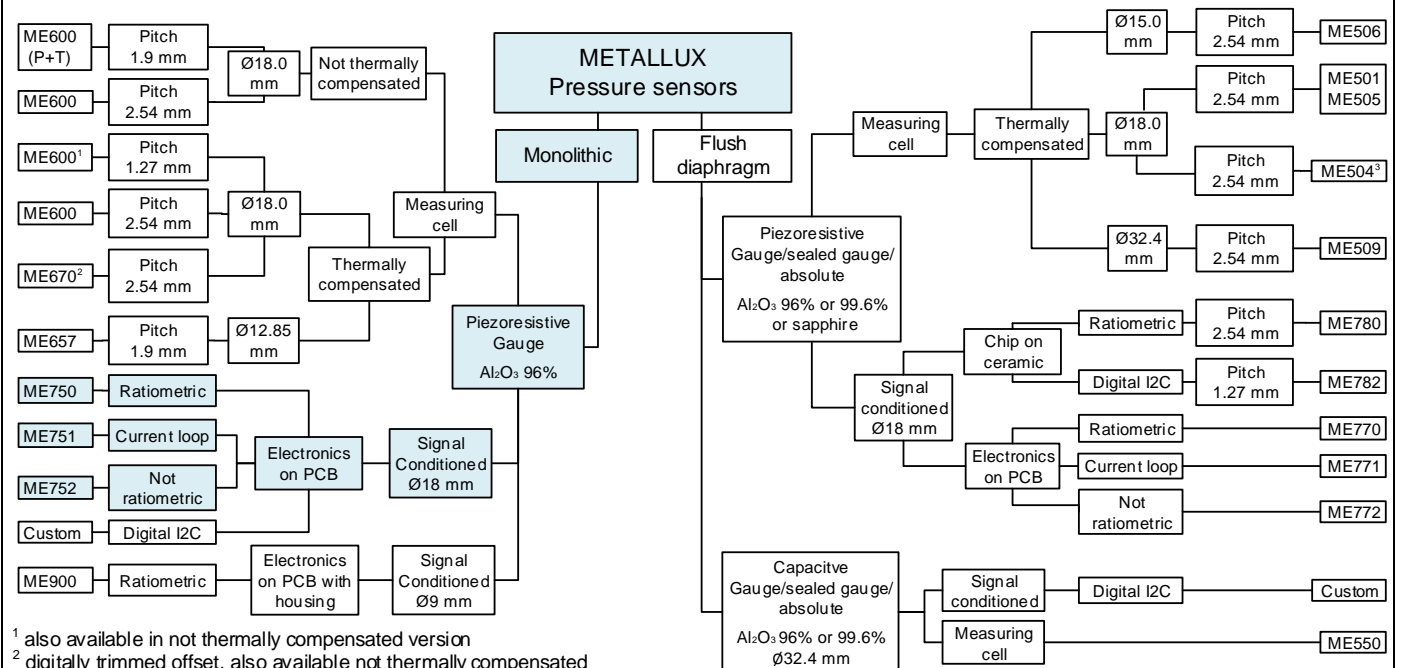

Technical characteristics

Parameters	Units	ME750 / MEP750	ME751 / MEP751	ME752 / MEP752
Output	-	Ratiometric	Current loop	Non ratiometric
Output range	-	0.5...4.5 [V]	4...20 [mA]	0...10 [V]
Sensor type	-	Monolithic, gauge		
Technology	-	Piezoresistive with electronic signal conditioning		
Material	-	Ceramic Al ₂ O ₃ 96%		
Weight	g	≤ 8 (with standard wires)		
Response time	ms	≤ 5		
Supply voltage	VDC	4.5...5.5	9...35	12...35
Max current ¹	mA	6 (R _{LOAD} ≥ 2 kΩ)	4...20	8 (R _{LOAD} ≥ 2 kΩ)
Operating temp.	°C	-25...+125 (-13 °F...+257 °F)		
Storage temp.	°C	-40...+135 (-40 °F...+275 °F)		
Compliant with	-	REACH, RoHS, Conflict Minerals free		
EMC / ESD compliance ²	-	IEC/EN 61000-4-2 ESD immunity IEC/EN 61000-4-3 Rad. EM field imm. IEC/EN 61000-4-4 EFT / Burst ³ imm. IEC/EN 61000-4-5 → Not applicable IEC/EN 61000-4-6 Conducted RF imm.	IEC/EN 61000-4-2 ESD immunity IEC/EN 61000-4-3 Rad. EM field imm. IEC/EN 61000-4-4 EFT / Burst imm. IEC/EN 61000-4-5 Surge immunity IEC/EN 61000-4-6 Conducted RF imm.	IEC/EN 61000-4-2 ESD immunity IEC/EN 61000-4-3 Rad. EM field imm. IEC/EN 61000-4-4 EFT / Burst ³ imm. IEC/EN 61000-4-5 → Not applicable IEC/EN 61000-4-6 Conducted RF imm.

Pressure range			ME75x / MEP75x															
Nominal	ME	bar	1.6	2	2.5	4	5	6	10	16	20	25	40	50	100	200	250	400
Pressure ⁴	MEP	psi ⁵	20	30	50	60	100	115	150	300	400	500	750	1000	1500	3000	4000	5000
Overload pressure		bar	4	4	10	10	10	10	20	40	40	40	100	100	200	300	375	500
		psi	58	58	145	145	145	145	290	580	580	580	1450	1450	2175	4350	5440	7250
Burst pressure		bar	8	8	20	20	20	20	35	60	60	60	140	140	300	400	500	650
		psi	116	116	290	290	290	290	507	870	870	870	2030	2030	4350	5800	7250	9425
Vacuum capability		bar	-0.8	-0.8	-0.9	-0.9	-0.9	-0.9	-1	-1	-1	-1	-1	-1	-1	-1	-1	-1
		psi	-11.6	-11.6	-13.1	-13.1	-13.1	-13.1	-13.1	-14.5	-14.5	-14.5	-14.5	-14.5	-14.5	-14.5	-14.5	-14.5

Accuracy ⁶ [%FS]	Calibration with high accuracy																
25°C (77 °F)	1.5	1.0														1.5	
A) 0...85°C (32...185 °F)	1.5			1.4			1.6			1.8			2.4			2.4	
B)-10...105°C (14...221 °F)	1.8			1.7			1.8			2.2			2.6			2.6	
C)-25...125°C (-13...257°F)	2.2			2			2.2			2.5			3.5			3.5	
Accuracy ⁶ [%FS]	Calibration with standard accuracy																
25°C (77 °F)	1.5	1.0														1.5	
A) 0...85°C (32...185 °F)	2.5			2.4			2.6			2.8			3.4			3.4	
B)-10...105°C (14...221 °F)	3.8			3.7			3.8			4.2			4.6			4.6	
C)-25...125°C (-13...257°F)	4.2			4.0			4.2			5.5			5.5			5.5	
Accuracy ⁶ [%FS]	Calibration without thermal compensation																
25°C (77 °F)	1.5	1.0														1.5	
-25...125 °C (-13...257°F)	Max ± 0.08 %FS/K (Ceramic cell thermal offset shift + thermal span shift) + Accuracy at 25°C																

Unless indicated, all data are based on a reference temperature of 25°C.

1. During calibration or auto-zero, current consumption is < 30 mA.
2. All EMC/ESD tests are performed in Metallux metallic housing grounded.
3. EFT/Burst level is according to EN 61326-1:2013
4. Pressure ranges not shown specifically in the technical chart have performance of the nearest listed pressure range.
5. Psi values are not the exact conversion of bar value. Psi ranges are defined to cover different standard values.
6. Accuracy includes room temperature error of non-linearity, hysteresis and non-repeatability, offset and span deviation PLUS thermal span shift and thermal offset shift. Accuracy calculation is performed in Metallux housings; accuracy excludes temperature hysteresis which primarily depends on mechanical conditions (housing, o-ring, etc) of actual application.

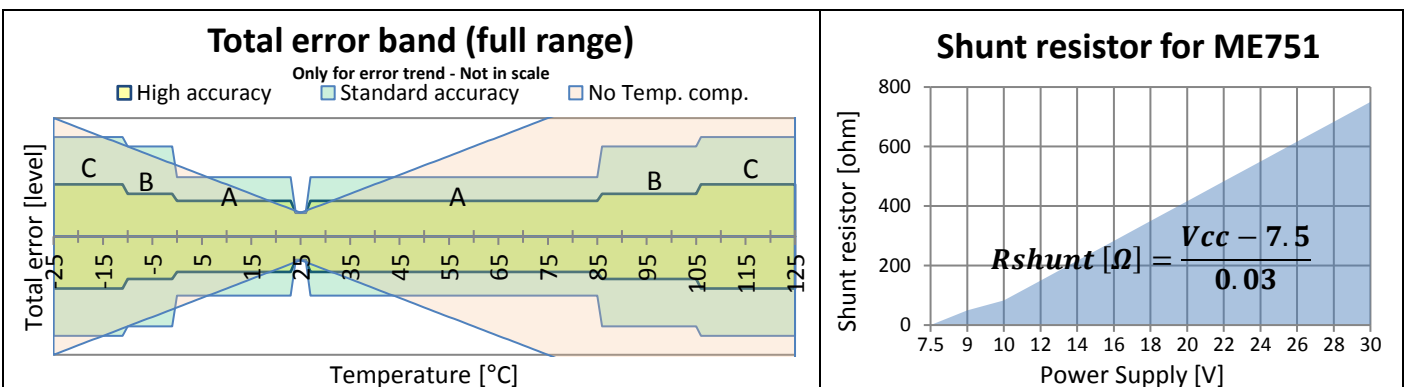

Mechanical drawings

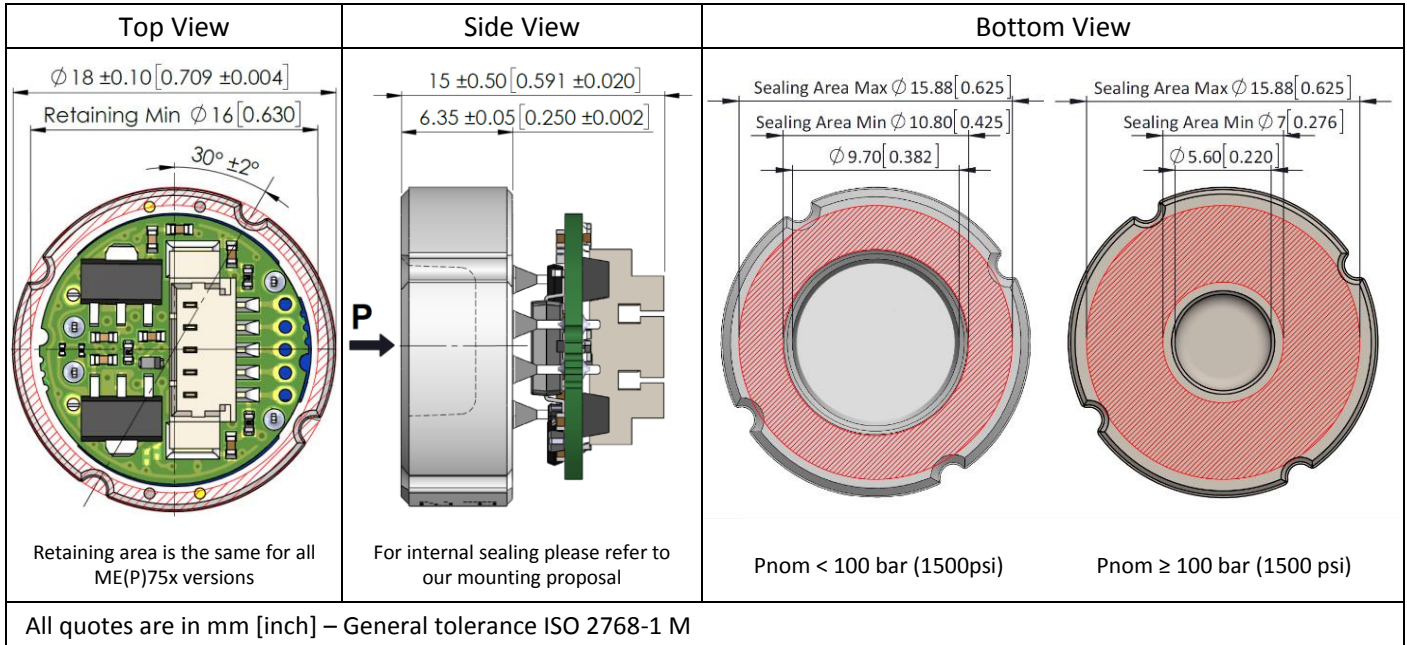

Electrical terminations

ME750 Example: type 0, Connector plus 52 mm cable

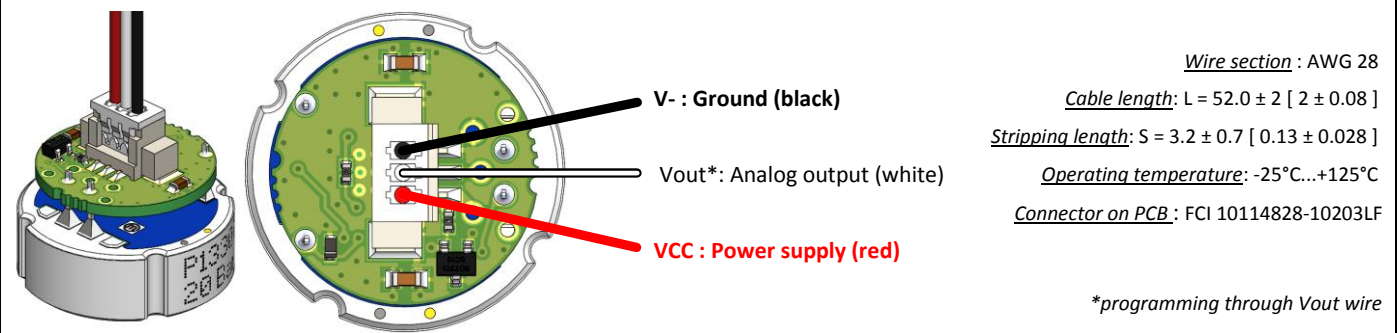

ME751 Example: type 2, Connector plus 52 mm cable with programming wires

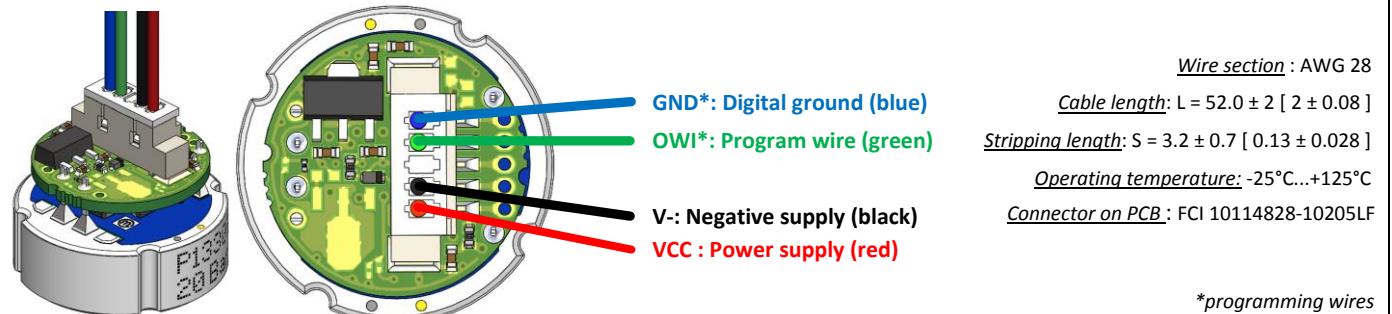

ME752 Example: type 2, Connector plus 52 mm cable with programming wires

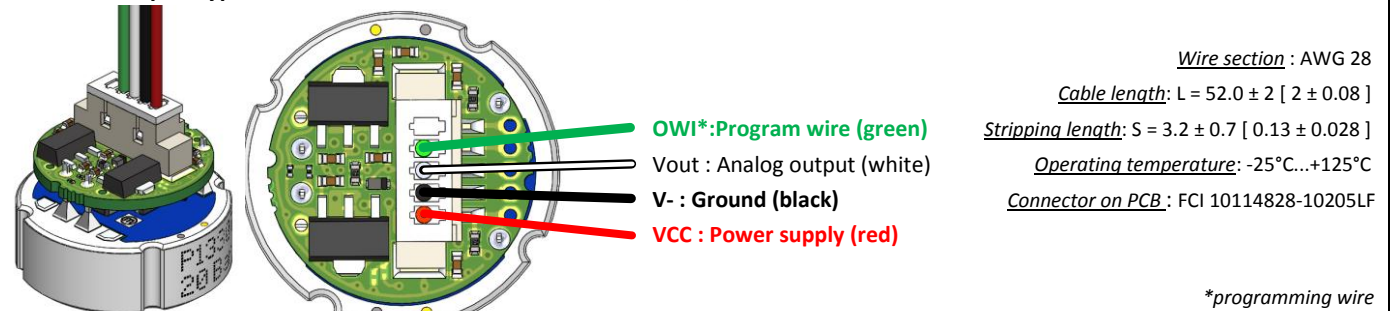

All quotes are in mm [inch] – General tolerance ISO 2768-1 M

Ordering code

	ME	-	75	-	---	-	-	-
Pressure unit	bar							
	psi	blank	P					
Output signal	Ratiometric	0.5...4.5 [V]		0				
	Current loop	4...20 [mA]		1				
	Non ratiometric	0...10 [V]		2				
Pressure range	ME		MEP		ME – MEP			
	0...1.6 bar	or	0...20 psi		1p6 – 020			
	0...2 bar	or	0...30 psi		002 – 030			
	0...2.5 bar	or	0...50 psi		2p5 – 050			
	0...4 bar	or	0...60 psi		004 – 060			
	0...5 bar	or	0...100 psi		005 – 100			
	0...6 bar	or	0...115 psi		006 – 115			
	0...10 bar	or	0...150 psi		010 – 150			
	0...16 bar	or	0...300 psi		016 – 300			
	0...20 bar	or	0...400 psi		020 – 400			
	0...25 bar	or	0...500 psi		025 – 500			
	0...40 bar	or	0...750 psi		040 – 750			
	0...50 bar	or	0...1000 psi		050 – 1k0			
	0...100 bar	or	0...1500 psi		100 – 1k5			
	0...200 bar	or	0...3000 psi		200 – 3k0			
0...250 bar	or	0...4000 psi		250 – 4k0				
0...400 bar	or	0...5000 psi		400 – 5k0				
Others on request (please specify)				999 – 999				
Calibration	High accuracy					0		
	Standard accuracy					1		
	No temperature compensation (calibration done at room temperature)					2		
	Not calibrated, not compensated (electrical test only)					3		
	Others on request (please specify)					9		
Termination type	Connector plus 52 mm cable						0	
	Only connector						1	
	Connector plus 52 mm cable with programming wires (only for current loop and non ratiometric)						2	
	Others on request (please specify)						9	
	Additional coating							
Without							0	
Others on request (please specify)							9	

Conversion tools

