

PRODUCT SPECIFICATIONS

MODEL NO.	MOTOR	RPM		AMPS		HP	kW	NET WT.		CAPACITOR	
		60HZ	50HZ	60HZ	50HZ			lbs.	kg	mfd.	VOLT
86R130-VS101-N270X	100-120/200-240 (60Hz) 100-120/200-240 (50Hz)	1725	1425	1.8/1.0	3.1/1.5	1/4	0.19	14.9	6.8	30	370

SOUND LEVEL LESS THAN 50 db(A)

NORMAL AMBIENT +5 °C - +40 °C

RELATIVE HUMIDITY 20% - 80%

ENVIRONMENT CLEAN DUST FREE

NOTES:

1. TECHNICAL DATA SUBJECT TO CHANGE WITHOUT NOTICE.
2. THIS PUMP MUST BE INSTALLED IN AN ENCLOSURE.
3. ALL DIMENSIONS ARE FOR REFERENCE ONLY.
4. KIT P/N: K961.
5. THIS UNIT INCORPORATES SOUND SHIELD (SSV-01).

PRODUCT PERFORMANCE: 50Hz CURVES BASED ON 230V.
 60Hz CURVES BASED ON 115V.

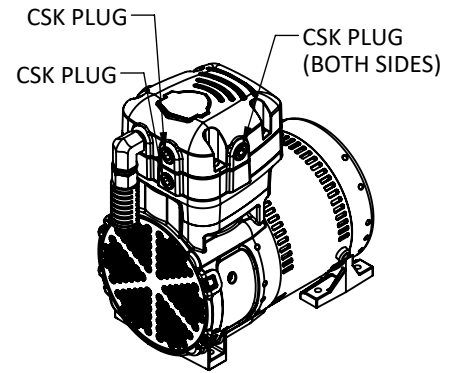
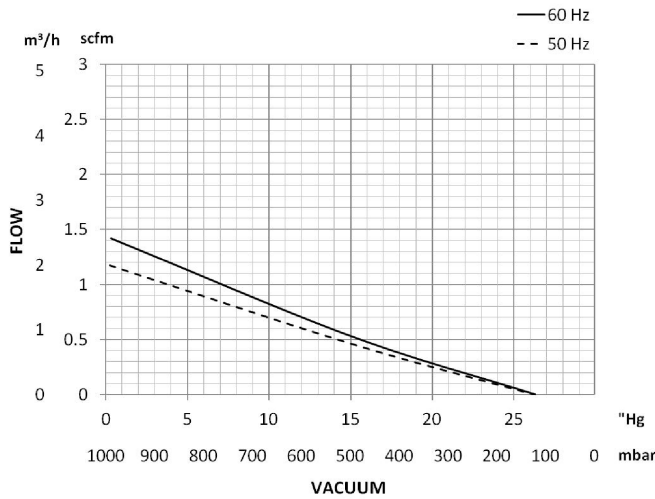

PRODUCT DIMENSIONS:

WIRING DIAGRAM

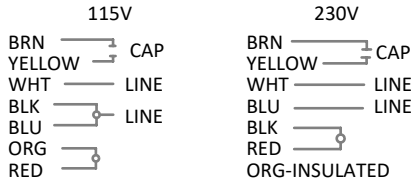

CAPACITOR MOUNTING KIT TO BE SHIPPED UNATTACHED.

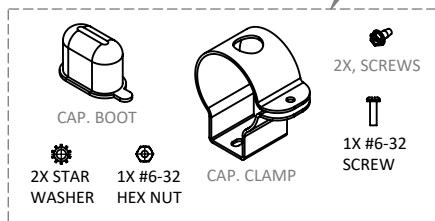

CAPACITOR TO BE SHIPPED UNATTACHED

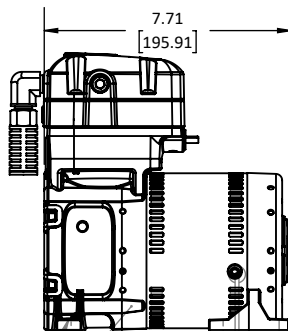
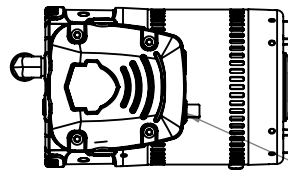

1/4 NPT (INLET)

5X, MOTOR LEADS #18 AWG. 29.0 ±1.0 LG., STRIPPED .374 ±.06.

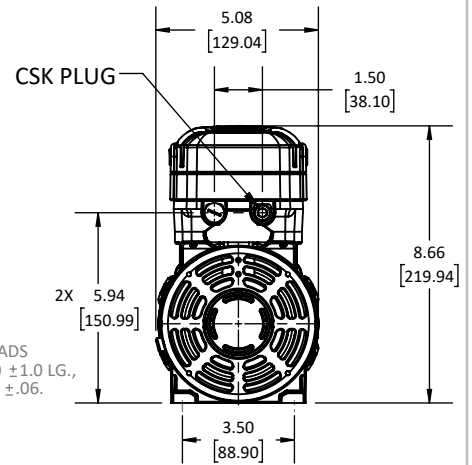

CSK PLUG

2X, MOTOR LEADS #18 AWG. 29.0 ±1.0 LG, .032 x .250 FEMALE TERMINALS BRN & YEL LEADS (TO CAPACITOR)

GROUND SCREW (OPPOSITE SIDE)

2X 4.75 [120.68]

2X, 1.75