





PRODUCT SPECIFICATION

GAST

A UNIT OF **DEX** CORPORATION
BENTON HARBOR, MI U.S.A.

					PART NUMBER: RTD789 SHEET 1 OF 2	REV. A
3000	<70 dB(A)	°C	20% - 80%	12.75 LBS. 5.80 kg.		
V	HP	kW	Hz	A	MODEL NO. DOA-P501-KH	
12 DC	1/6	.12	---	20.0		

NOTES:



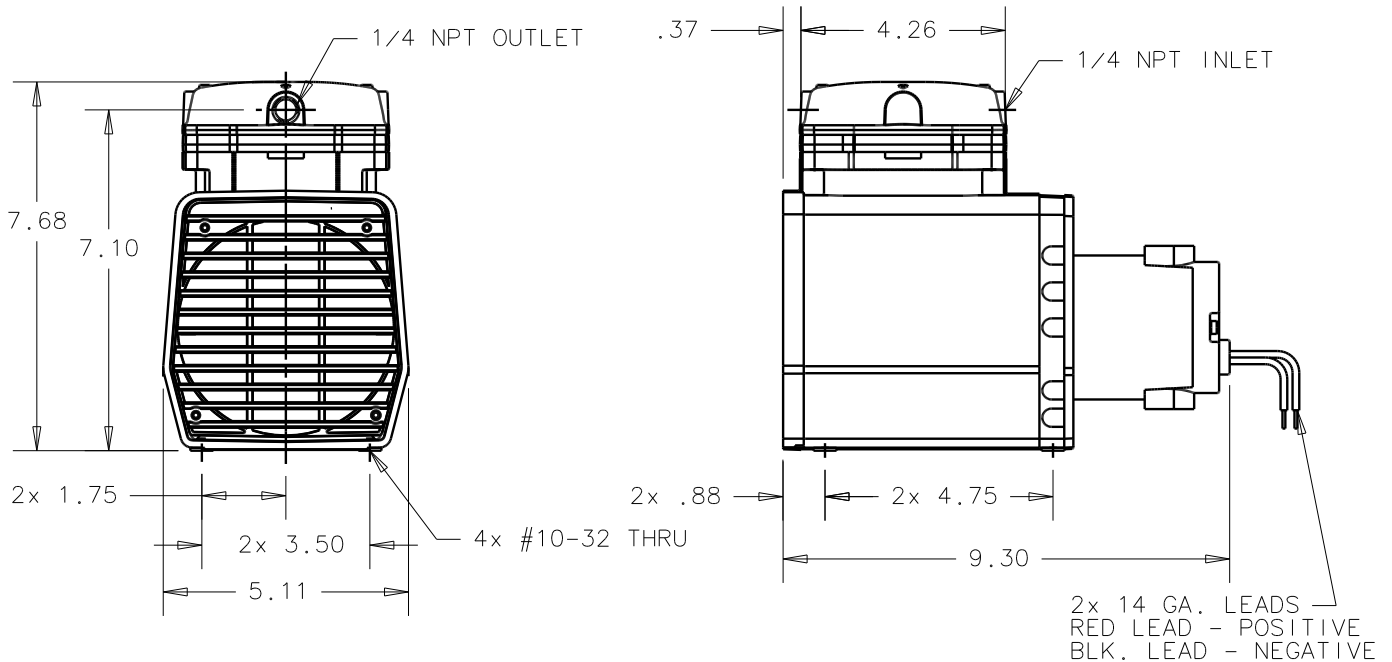
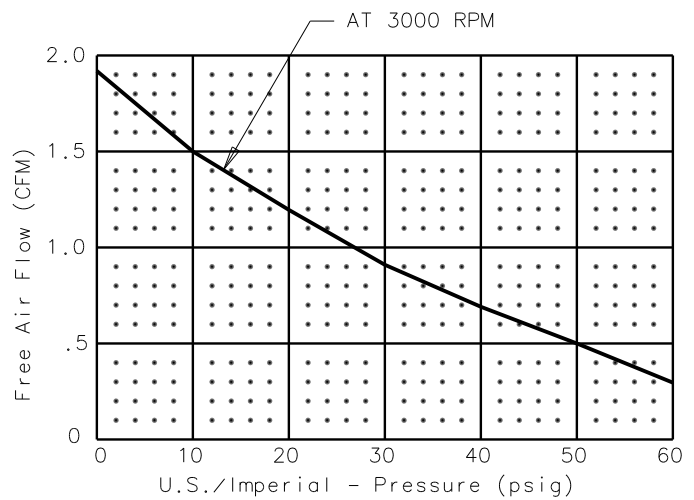
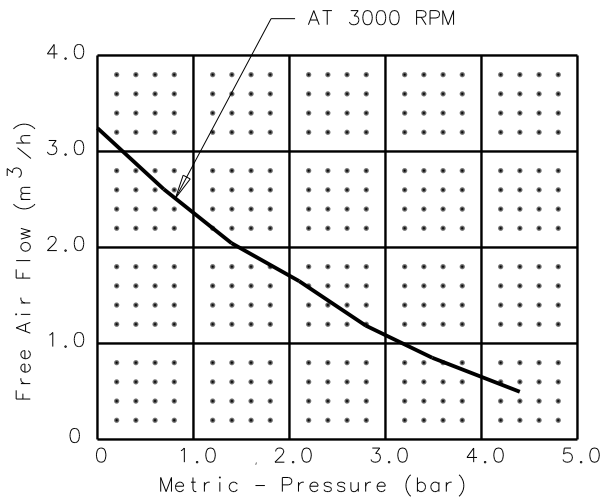

1. PRODUCT DIMENSIONS: ALL DIMENSIONS ARE REFERENCE ONLY.
2. PRODUCT DIMENSIONS: U.S. IMPERIAL (inches).
3. TECHNICAL DATA SUBJECT TO CHANGE WITHOUT NOTICE.
4. ENVIRONMENT: CLEAN DUST FREE.
5. THIS MODEL REQUIRES ADDITIONAL CAPACITANCE TO BE APPLIED TO ELECTRICAL INPUT ON ORDER TO COMPLY WITH THE CE EMC DIRECTIVE.



PRODUCT SPECIFICATION

GAST

A UNIT OF **LGX** CORPORATION
BENTON HARBOR, MI U.S.A.

		 +40 +5		
3000	<70 dB(A)	°C	20% - 80%	12.75 LBS. 5.80 kg.
V	HP	kW	Hz	A
12 DC	1/6	.12	---	20.0

PART NUMBER:	RTD789	REV. A
	SHEET 2 OF 2	
MODEL NO.	DOA-P501-KH	

