

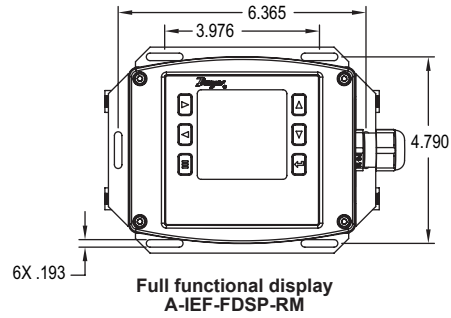

Series A-IEF Remote Display

Specifications - Installation and Operating Instructions

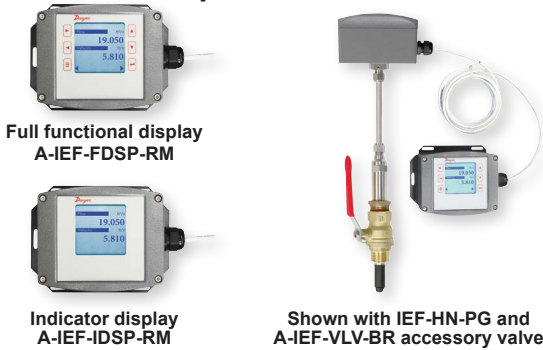

The **Series A-IEF Remote Display** can be installed almost anywhere near a Series IEF flow transmitter or IEFB thermal energy meter. Both the indicator display (A-IEF-IDSP-RM) and the full functional display (A-IEF-FDSP-RM) have a maximum display cable length of 100 ft (30 m) to permit easy viewing of flow readings. The full functional display allows for convenient adjustment of configuration settings and allows the user to save the IEF or IEFB configuration settings to a computer for printing.

FEATURES/BENEFITS

- Full functional display can be used to set up the IEF/IEFB and adjust the settings if it is installed in a hard-to-reach location.
- Indicator display makes it convenient to read process values if the meter is inaccessible.
- Varying cable lengths of up to 100 ft (30 m) allows for flexible installation on a wall or pipe mount.
- Easy to install and wire in the field.

APPLICATIONS

- Mechanical rooms with a small footprint
- Hard-to-reach piping
- Boilers and chillers
- Chilled water
- Condenser water
- Make-up water
- Heating water
- Boiler feed water
- Steam condensate

MODEL CHART	
Model	Description
A-IEF-FDSP-RM	A-IEF-DSP-RM full functional remote display (CE)
A-IEF-IDSP-RM	A-IEF-DSP-RM indicator remote display

ACCESSORIES	
Model	Description
A-IEF-CBL-50	Plenum rated cable 50 ft (15.2 m)

SELLABLE PARTS	
Model	Description
A-IEF-LID	IEF blank replacement lid assembly

INCLUDED WITH THE REMOTE DISPLAY

Carefully unpack the shipping container of the remote display and remove the following items:

- (1) Remote display with mounting bracket
- (1) 3 hole grommet (not shown)
- (2) Pipe clamps
- (1) 3 mm allen wrench (not shown)
- (1) 1/2" NPT conduit fitting (not shown)
- (1) Adapter PCBA board, screw and stand-off (not shown)

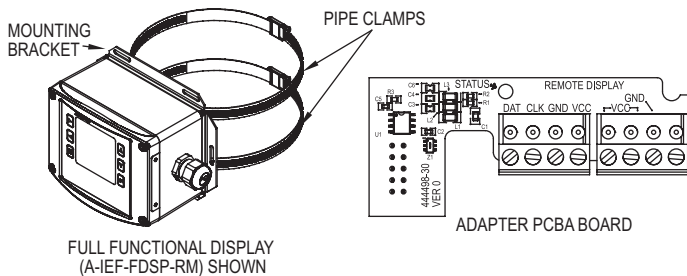

Figure 1: Included items

RECOMMENDED INSTALLATION TOOLS

- Philips #2 screwdriver
- 1/8" slotted screwdriver
- Appropriate fasteners for wall mounting (wall mount installations)
- 5/16" nut driver or 1/4" slotted screwdriver (pipe mount installations)
- 1/4" nut driver (for standoff installation)

SPECIFICATIONS

Temperature Limits: Ambient: -4 to 158°F (-20 to 70°C); Storage: -40 to 185°F (-40 to 85°C).
Display: 3.3" diagonal graphic LCD. Backlight (full display only).
Enclosure Material Housing: Powder coated die cast aluminum.
Enclosure Rating: NEMA 4X (IP66).
Electrical Connection: Removable terminal blocks, #22 AWG (100 ft (30 m) max).
Mounting: Wall or pipe mount.
Mounting Orientation: Any orientation.
Weight: 2.46 lbs (1.12kg).

INSTALLATION

The Series IEF/IEFB can support one display. If the IEF/IEFB has the local LCD display option (-LCD), the display will need to be replaced by a blank cover (blank cover offered separately, part number A-IEF-LID). The remote display must be connected to the IEF/IEFB flowmeter with an eight conductor shielded cable (maximum length of 100 ft (30 m)). The provided adapter PCBA board will need to be installed in the IEF/IEFB flowmeter to connect to the remote display cable. For installations where the remote display is attached to a pipe, the included pipe clamps should be used.

Note: The power to the IEF/IEFB must be turned off before installation of the remote display.

Mounting the Remote Display

Locate an appropriate location that allows for visibility of the remote display. The remote display is suitable for mounting on a flat surface or mounted to a pipe in any orientation; clamps are supplied for pipe sizes 3" to 12" (76.2 to 304.8 mm).

Surface/Wall Mount

To mount the remote display to a flat surface such as a wall, hold the remote display in the desired location, mark hole locations on the flat surface using the attached bracket as a template, drill holes and mount the remote display with screws suitable for surface and bracket slot dimensions.

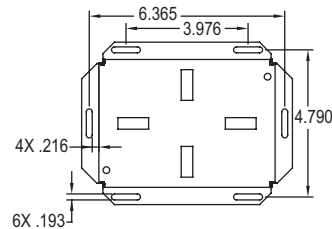

Figure 2: Surface mount template (reverse view, not to scale)

Pipe Mount

To mount the remote display to a pipe, thread the pipe clamp through the appropriate slots on the mounting bracket as shown below in Figure 3.

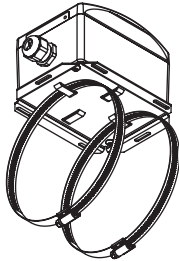

Figure 3: Pipe clamps

Once the pipe clamps are in place, the remote display may be mounted in any orientation. See Figure 4 below for recommended orientations.

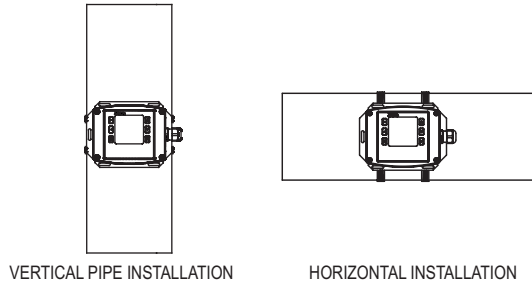

Figure 4: Pipe installation

WIRING

Remote Display Cable Installation and Wiring

The cable connecting the remote display to the Series IEF or IEFB will wire into two removable terminal blocks located on the back of the remote display lid.

The cable will need to have a sufficient service loop inside the remote display for easy access [9" (22 cm) is recommended]. Similar to the IEF/IEFB, the cable wires should be stripped approximately 0.22 in (5.59 mm). A 1/8" slotted screwdriver can be used to tighten the terminal block screws. For Dwyer Instruments plenum cable A-IEF-CBL-X, the recommended colors codes are:

Remote Display Terminal	Wire Color	Remote Display Terminal	Wire Color
DAT	Black	VCC	Yellow
CLK	Brown	VCC	Green
GND	Red	GND	Blue
VCC	Orange	GND	Violet
SHIELD*	Metal		

*Connect the shield/drain wire on CE units.

Note: Refer to Figure 5 wiring diagram for proper wiring of remote display to IEF/IEFB.

*Connect the shield/drain wire on CE units.

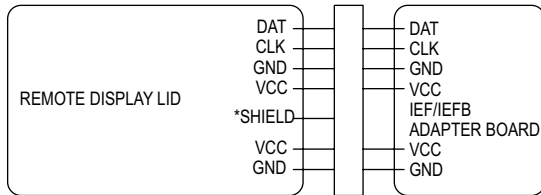

Figure 5: Wiring diagram

Note: Use the USB connector near the terminal blocks to connect the display to a computer in order to print out the configuration values for the IEF/IEFB (supported on the full functional display only). See the IEF/IEFB manual F-IEF-F or F-IEFB-F for details.

Note: For full functioning display A-IEF-FDSP-RM if the display lock out feature is desired the switch is located on the back of the display as shown below:

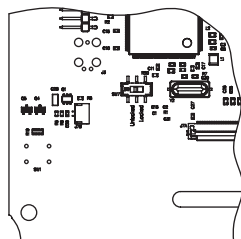

Figure 6

In order for the remote display to operate an adapter PCBA board, shown below, must be installed in the display port of the Series IEF or IEFB.

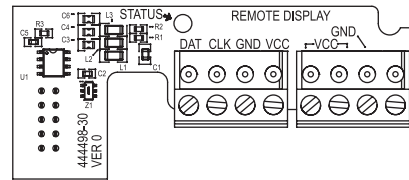

Figure 7: Adapter PCBA board

The terminal block wire entries face the center of the cover. After connecting the cable to the remote display, use a 3 mm Allen wrench to remove the tether-mounting screw from the IEF/IEFB and install the remote display cover to the housing (The cover has four screws).

Using the supplied 3mm Allen wrench, begin by unscrewing the (4) captured screws of the Series IEF or Series IEFB to remove the lid from the enclosure.

Note: The lid is tethered to the IEF/IEFB enclosure to allow for convenient wiring. The lid is only tethered in the base unit.

Mount the adapter board and affix to the Series IEF or IEFB by screwing in supplied screw to the stand off as pictured below.

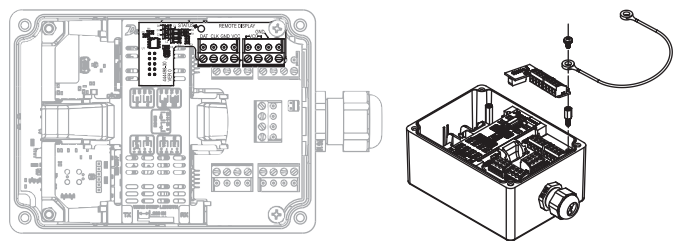

Figure 8: Installed IEF/IEFB adapter PCBA board with tether

Feed the remote display wiring cable into the Series IEF/IEFB housing through the grommet, as shown below. Connect to the removable terminal blocks located on the adapter board.

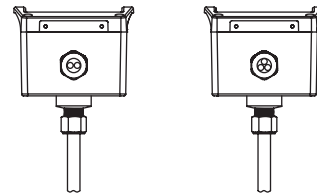

Figure 9: IEF/IEFB grommet two and three hole grommet

IEF/IEFB Cable Installation (cable gland option):

If the IEF/IEFB has a cable gland option with a 2 hole grommet, insert the included 3 hole insert. First, disconnect the A and B cables from the IEF/IEFB terminal blocks. Fully loosen the cable gland nut onto the A and B cables. Remove the cables from the IEF/IEFB. Remove the two hole cable gland insert and install the included 3 hole cable gland insert. This will allow each cable to be installed in the IEF/IEFB. For easier installation, insert the remote display cable, the A cable, and the B cable at the same time. Connect the A and B cables to the IEF/IEFB terminal blocks (See the IEF/IEFB manual F-IEF-F or F-IEFB-F for details.) After connecting the A and B cables, the IEF/IEFB PCBA adapter board can be installed.

Once the wiring of the remote display is complete, install a blank cover on the IEF unit (not a LCD cover). Use a 3 mm hex key to tighten the four cover screws.

MAINTENANCE/REPAIR

Upon final installation of the Series IEF Remote Display, no routine maintenance is required. The display is not field serviceable and it is not possible to repair the unit. Field repair should not be attempted and may void warranty.

Power must be supplied to the IEF/IEFB prior to this unit being operational. For further instruction on display use refer to bulletin F-IEF-F or F-IEFB-F

WARRANTY/RETURN

Refer to "Terms and Conditions of Sale" in our catalog and on our website. Contact customer service to receive a Return Goods Authorization number before shipping the product back for repair. Be sure to include a brief description of the problem plus any additional application notes.