

Beck.

The adjustable pressure switches Prescal[®] in Ex zones



Pressure switch 901..Ex Prescal®

with adjustable pressure setting
for Ex zones 1, 2 and 21, 22



Application

Adjustable pressure switch monitoring overpressure, vacuum or differential pressure of liquid and gaseous – also aggressive – media

The switching pressure can be adjusted without a pressure gauge using a scaled adjustment knob.

Temperature range

Ambient and media temperature from -20°C to $+85^{\circ}\text{C}$

Diaphragm material

Depending on media NBR, Silicone, FKM, EPDM
For 901.8xEx Silicone, others upon request

Electrical rating

max. 100 mA / 24 VAC, 30 mA / 24 VDC

Electrical connection

Tab terminal 6.3 mm x 0.8 mm in accordance with DIN 46244
or push-on screw terminals

Cable conduit

M16x1.5 with integrated cable strain relief

Life

Mechanically more than 10^6 cycles

Weight

30 to 300 g (depending on housing material)

Damping

Restrictors alternatively with 0.3/0.5/0.8 mm diameter

Protection

IP54 / IP65 depending on the used protection cap

Protection class

Protection class II is only met by using a protection cap from our accessories program.

Warning

Read instructions before use. This regulating and control unit must be installed in compliance with the applicable regulations.

Accessories

Various mounting brackets and protection caps with IP 54 and IP 65

ATEX

EC type examination Device category	BVS 06 ATEX E 141 X II 2G and II 2D
Ignition protection type	Ex ia IIC T4 Gb and Ex ia IIIB T135°C Db
Conformity	EU ATEX Directive EU RoHS Directive
Other approvals	type examination by TUV Südwest and DVGW

Ex i-circuits

This pressure switch can be used in potentially explosive zones for gas in zones 1 & 2 and for dust in zones 21 & 22. In the safe area, an associated isolating means (separating barrier, switching amplifier) must be connected before. The entire isolating circuit must then be proved to keep inherent safety. For this purpose, the power specifications (P, I, U) of the barrier must be lower and the characteristics (L, C) higher than those of the pressure switch and of the connection line (blue colour).

Characteristics:

Gas for IIC: 30 VDC / 60 mA; 24 VDC / 100 mA
Dust for IIIB: 30 VDC / 60 mA / 0,6 W
Capacitance - Ci 0 μF
Inductance - Li 0 mH

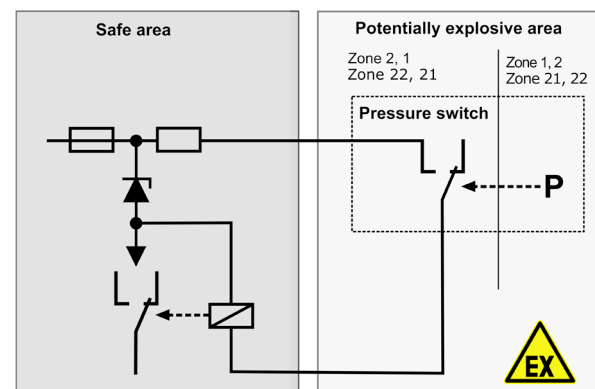

Arrangement of contacts

for 901.6xEx, 901.8xEx, 901.9xEx only for 901.7xEx



Pressure connection

Type	Tube connection			Threaded connection			
	5.0 mm	6.5 mm	10.0 mm	M10x1	G1/8	G1/4	G1/2
901.61 - 65Ex	PA	PA, PPS	PA, PPS	PA, PVDF CuZn40, V ₂ A	PA, PVDF CuZn40, V ₂ A	CuZn40, V ₂ A	CuZn40
901.66 - 68Ex				CuZn40, V ₂ A	CuZn40, V ₂ A	CuZn40, V ₂ A	CuZn40
901.71 - 76Ex	PA	PA, PPS	PA, PPS	PA, PVDF CuZn40, V ₂ A	PA, PVDF CuZn40, V ₂ A	CuZn40, V ₂ A	
901.77 - 78Ex				CuZn40, V ₂ A	CuZn40, V ₂ A	CuZn40, V ₂ A	CuZn40
901.8xEx		PA					
901.91 - 93Ex				CuZn40	CuZn40, V ₂ A	CuZn40, V ₂ A	

PA = polyamide, PVDF = polyvinylidene fluoride, PPS = polyphenylsulfide, CuZn40 = brass, V₂A = stainless steel

For temperature above 85° C metal or PPS pressure connection is required. Upon request pressure connections of other sizes, other plastics or brass nickel-plated are available.

Prescal® is a registered trademark of Beck Sensortechnik GmbH

Overpressure range

Type	Adjustment range for trip pressure		Switching differential	Maximum positive working pressure standard/extended	Maximum negative working pressure standard/extended
	from	to			
901.61Ex	5 mbar	20 mbar	3 mbar	0.5 / 4 bar	- / - 1 bar
901.62Ex	10 mbar	50 mbar	5 mbar	0.5 / 4 bar	- / - 1 bar
901.63Ex	25 mbar	100 mbar	10 mbar	0.5 / 4 bar	- / - 1 bar
901.64Ex	50 mbar	250 mbar	20 mbar	1 / 4 bar	- / - 1 bar
901.65Ex	100 mbar	500 mbar	50 mbar	1 / 4 bar	- / - 1 bar
901.66Ex	250 mbar	1,000 mbar	150 mbar	10 bar	- 1 bar
901.67Ex	500 mbar	1,500 mbar	250 mbar	10 bar	- 1 bar
901.68Ex	1,000 mbar	3,000 mbar	500 mbar	10 bar	- 1 bar
901.91Ex	1.0 bar	6.0 bar	0.5 – 2.0 bar	25 bar	- 1 bar
901.92Ex	4.0 bar	9.0 bar	0.5 – 2.0 bar	25 bar	- 1 bar
901.93Ex	7.0 bar	12.0 bar	0.5 – 2.0 bar	25 bar	- 1 bar

Vacuum range

901.71Ex	-5 mbar	- 20 mbar	3 mbar	0.5 / 4 bar	- 1 bar
901.72Ex	-10 mbar	- 50 mbar	5 mbar	0.5 / 4 bar	- 1 bar
901.73Ex	-25 mbar	-100 mbar	10 mbar	0.5 / 4 bar	- 1 bar
901.74Ex	-50 mbar	-125 mbar	20 mbar	0.5 / 4 bar	- 1 bar
901.75Ex	-75 mbar	-200 mbar	25 mbar	1 / 4 bar	- 1 bar
901.76Ex	-100 mbar	-300 mbar	30 mbar	1 / 4 bar	- 1 bar
901.77Ex	-200 mbar	-500 mbar	75 mbar	1 / 4 bar	- 1 bar
901.78Ex	-300 mbar	-700 mbar	75 mbar	1 / 4 bar	- 1 bar

Differential pressure range

901.81Ex	5 mbar	20 mbar	3 mbar	100 mbar	-100 mbar
901.82Ex	10 mbar	50 mbar	5 mbar	100 mbar	-100 mbar

Dimensional Drawings

901.6xEx/7xEx

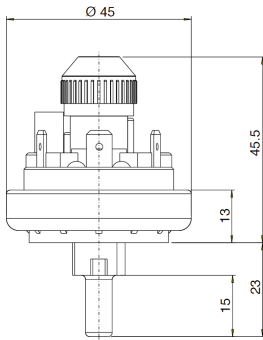

901.8xEx

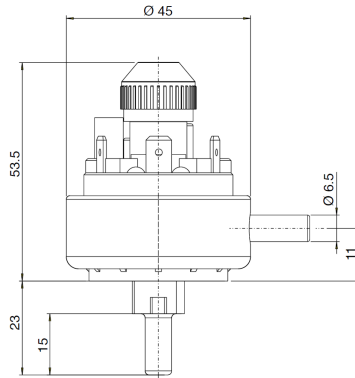

901.6xEx/7xEx/41Ex

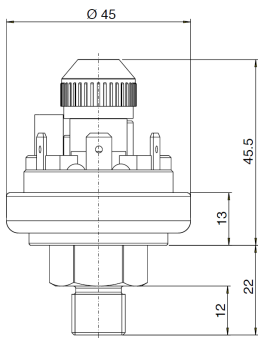

901.9xEx

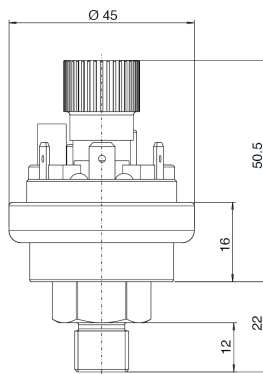

Protection caps

6371 IP54 / 6372 IP65

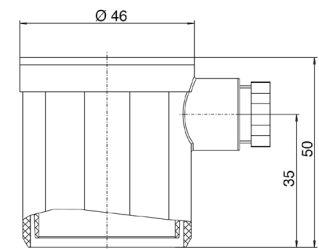

Mounting brackets

6403

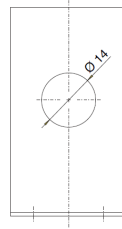

6404

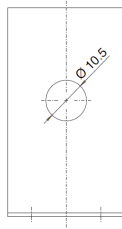

6405

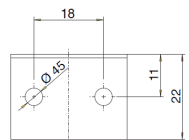
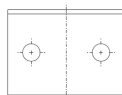
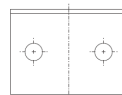
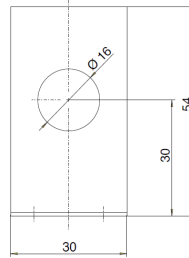

6374 IP54 / 6375 IP65

