



SPHERA GROUP

LABORATORY REFRIGERATOR

LR 1160 W xPRO (White finishing)

LR 1160 S xPRO (Stainless steel finishing)

- **Structure:** upright type, realized in sheet steel with special anti-bacterial epoxy coating white colour both in- and outside or in stainless steel 18/10 AISI 304 both in- and outside. All the internal corners are rounded to make easy any cleaning operations and the internal bottom is tray type to contain spills
- **Insulation:** high density (40 Kg/m³) foamed-in-place polyurethane, with a thickness of 75 mm. CFC-free
- **Feet:** Nr 4 made in stainless steel 18/10 AISI 304, adjustable in height for levelling
- **Insulated doors:** Nr 2, hinged, side-by-side, made with the same material and insulation as the rest of the structure (sheet steel with special anti-bacterial epoxy coating white colour or stainless steel 18/10 AISI 304 always both in- and outside). The doors are provided with a removable magnetic rubber gaskets in order to grant a perfect hermetic closing. The handles are flush-fitting type so do not increase the size of the refrigerator. The doors are also fitted with a spring loaded automatic closing devices for openings inferior 90° and special door switches that stop the internal ventilation at the door opening (to limit the air cold loss) and light the internal lighting at every opening
- **Internal equipment:** Nr 6 (3 for each door) storage open wire shelves realized in sheet steel with a strong plastic coating (rust-proof material). The shelves are mounted on special anti-tilt stainless steel slides that allows the shelf extraction and they can be easily removed and adjusted in height without the use of any tool. The special internal racking-system allows a great flexibility of the internal fitting with the possibility of interchange and combine both shelves and drawers (drawers optionally available)
 - Shelf dimensions (W x D cm): 53 x 55
 - Shelf loading capability (Kg): 35 (with uniformly stored material)
- **Internal lighting:** Nr 2 LED lamps, mounted in the bottom part of the control panel (1 above each door), with automatic activation at every door opening through a special switch
- **Control panel "xPRO":** located in the top part of the structure (above the door), microprocessor operating, with capacitive touch-buttons and colour display. The controller supervises all the appliance functions through the EEN (EVERmed Easy Navigation) interface, with icons and written messages, allowing a very intuitive interactivity between the appliance and the user, for an easy setting of all appliance functionalities according to needs and the control of the workings status. The control panel is battery operating in order to grant the functioning of the display and alarms even in case of power failure. The main functions panel are:
 - High resolution 3,5" TFT colour display, LED backlit, showing the appliance working status (actual temperature, compressor functioning, defrosting, alarm running, etc.) and allowing the surfing through the various controller menu for setting and checking purposes
 - Digital temperature displaying and adjusting with an accuracy of 0,1°C
 - Keyboard touch-buttons with automatic block safety protection, to avoid tampering from unauthorized persons
 - Dual-level safety access, with PIN code protections, on both ON/OFF switch and keyboard touch-buttons. Re-programmable PIN codes for increased security from access to the unauthorized personnel
 - Back-up battery, with automatic recharging, granting till 48 hours autonomy for the control panel functioning in case of power failure. The charging status is continuously shown on the display for immediate checking
 - Visual and acoustic alarm signalling (with automatic resetting) for:
 - high and low temperature, with limits programmable from the user through a dedicated menu

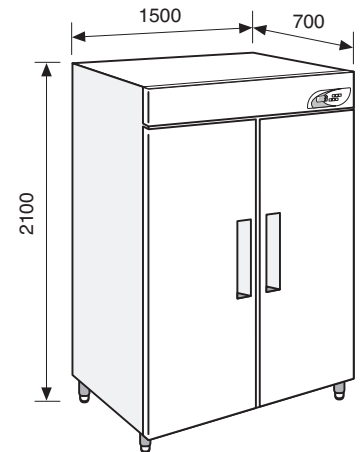









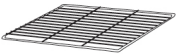

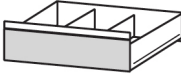

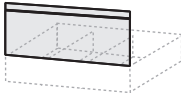



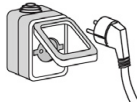
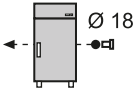
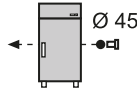

LABORATORY REFRIGERATOR

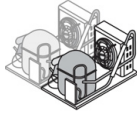
- door ajar, delayed of 2 minutes to allow the standard operations. Programmable alarm delay through a dedicated menu
- power failure
- battery discharged
- condenser dirty
- anti-freezing evaporator
- sensors failure
- Muting facilities for the acoustic alarms, with continuous warning indication on the display and automatic ring-back if the alarm situation persists. Programmable ring-back delay through a dedicated menu
- Test facilities for both control panel functioning, battery charging status and alarm limits
- Alarms log history for the latest 30 alarm conditions (not deletable), with the possibility of verify on the display, the alarm condition and all the related informations (starting time, ending time, highest/lowest peak of temperature reached where applicable)
- Door openings history for the latest 30 days (not deletable), with the possibility of verify on the display, the number of door openings, how many giving alarms and the total time that the door is kept open day-by-day
- Defrosts history for the latest 30 days (not deletable), with the possibility of verify on the type of defrost, starting time and the duration
- Internal ventilation setting facilities, in order to optimize the air-circulation according to the appliance using conditions and needs
- Real-time temperature chart, with surfing possibilities of the previous 52 hours of operations and zooming facilities for a better control of a period of interest
- Written indications on the display selectable from 3 languages (Italian, English and French)
- Pt1000 sensors for a better accuracy of the temperature control
- NO contact to remote the alarm signals
- Software upgrading facilities
- **Cooling unit:** top mounted, with the condensing unit compounded by Nr 1 hermetic compressors and Nr 1 finned condenser, air cooled through a fan. Also, in the ceiling of the storage chamber, is mounted the finned evaporator with copper pipes, that is housed into a stainless steel cover that incorporate the fan. All the mounted components are industrial grade to grant the maximum reliability
- **Refrigerant:** R452A CFC-free
- **Refrigeration:** forced-air, through a fan, granting the maximum temperature uniformity and stability inside of the cabinet
- **Defrosting:** completely automatic, thermostat controlled. The condensate water is automatically channelled into an heated tray, located in the cabinet backside, for the automatic evaporation of the condensate water
- **Temperature range:** infinitely adjustable between 0°C / +15°C
- **Voltage (V/ph/Hz):** 220-230/1/50
- **Plug:** Schuko type (type F+E)
- **Breakers:** Nr 2 glass cartridge fuses with a rating of 10A, at protection of the appliance
- **Noise level (dB(A)):** ≤ 52
- **Gross capacity (litres):** 1295 (45.71 cu.ft.)
- **Net capacity (litres):** 1160 (40.95 cu.ft.)
- **Dimensions (W x D x H cm):** 150 x 70 x 210
- **Net weight (Kg):** 220
- **Packed dimensions (W x D x H cm):** 158 x 98 x 224 (3,47 m³)
- **Gross weight (Kg):** 250

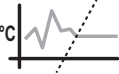
LABORATORY REFRIGERATOR

ACCESSORIES AVAILABLE

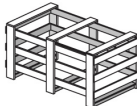
	Extra wire shelf		Extra stainless steel wire shelf
	Wire basket		Stainless steel drawer
	Plastic partitions for drawers		Front top for drawers
	Kit of castors		Safety door lock with key
	Temperature chart recorder		Data logger function with USB port
	Ballasted sensor for simulation of product temperature alarm		Internal electrical socket
	Cable port with cover Ø 18 mm		Cable port with cover Ø 45 mm
	Internal spark-proofing		Back-up cooling unit
	Air sterilization lamp		Safety anti-freezing thermostat
	Temperature uniformity and stability kit		Natural refrigerant R290
	GSM/GPRS telephone dialer		230V / 60 Hz Different voltage
	115V / 60 Hz Different voltage		Wooden crate packing



ISO 9001:2015



EN ISO 13485:2016



VERS. 04.20

* The declared performances are referred at +35°C ambient temperature, relative humidity of 70% and without any internal thermal mass (empty cabinet).

* Should it be necessary or useful without undermining any model essential features, technical and stylistic characteristics are subject to be changed without manufacturer's previous notice.

SPHERA GROUP s.r.o.

info@spha-group.cz

Tel: +420 226 886 248

Průmyslová 7 Business Park

102 00 Praha, Czech Republic



SPHERA GROUP