

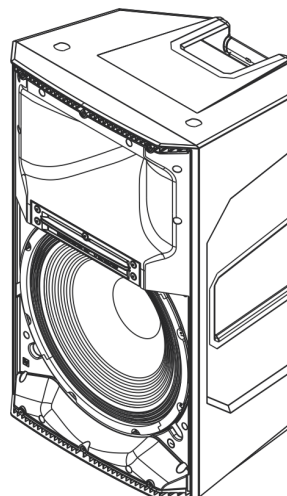

ELX200-15P 15" 2-Way Powered Speaker

- EV Quick**Smart** Mobile application: quickly and wirelessly configure, control and monitor up to six ELX200 loudspeakers simultaneously, and receive immediate notification during critical performance conditions. *Bluetooth® is available in select countries.*
- Quick**Smart**DSP features best-in-class processing. Easy setup via four presets, sub/top system-match, three-band EQ, five user-programmable presets, visual monitoring of limiter status, input level control and meters, and master volume control to optimize gain structure, all via LCD.
- High-efficiency 1200 W Class-D power amplifier delivers up to 132 dB peak SPL utilizing transducers designed and engineered by EV.
- EV-patented Signal Synchronized Transducers (SST) waveguide design provides precise and consistent coverage, minimal distortion, and maximized acoustical loading.
- Professional-grade hardware: three M10 threaded mounting points for forged eyebolts, integrated pole-mounts and the proven ZLX three-handle design for easy lifting.



ELX200-15P features high-efficiency Class-D power amplifiers (up to 1200 W) with integrated Quick**Smart**DSP, and delivers up to 132 dB SPL utilizing transducers designed and engineered by EV (15-inch EVS-15M woofer coupled with a DH-1C 1-inch titanium compression driver). Powered full-range models allow easy setup via four presets (Music, Live, Speech, Club), sub/top system-match crossovers, three-band EQ, five user-programmable presets (Store and Recall settings), visual monitoring of limiter status, input level control and meters, and master volume control to ensure optimal gain structure. ELX200 powered models are ideal for portable and

installed applications, with lightweight and durable polypropylene enclosures, three M10 threaded mounting points and the proven ZLX handle design for easy lifting.

The new Quick**Smart** Mobile wireless control and monitoring application, using Bluetooth® Low Energy (BTLE) technology, allows intuitive system control, configuration and monitoring of up to six powered ELX200 loudspeakers simultaneously. Receive alerts when your system is being overdriven, and control your system while *in front* of your speakers, not behind. *Bluetooth® is available in select countries.*

Technical specifications

Frequency response (-3 dB) ¹ :	55 Hz - 16 kHz
Frequency range (-10 dB) ¹ :	48 Hz - 19 kHz
Maximum SPL ² :	132 dB
Coverage (H x V):	90° x 60°
Power rating:	1200 W
LF transducer:	EVS-15M 381 mm (15 in)
HF transducer:	DH-1C 1-inch titanium compression driver
Crossover frequency:	1600 Hz
Connectors:	(1) Stereo RCA Input, (2) XLR/TRS combo jack, and (1) XLR
Enclosure:	Polypropylene
Grille:	18 AWG steel with powdercoat
Suspension:	(3) M10 suspension points
Color:	Black or white
Dimensions (H x W x D):	710 mm x 423 mm x 384 mm (28.0 in x 16.7 in x 15.2 in)
Net weight:	18.9 kg (41.7 lb)
Shipping weight:	21.8 kg (48.1 lb)
Power consumption ³ :	100 - 240 V~, 50 - 60 Hz, 1.8A

¹Full-space measurement using music DSP preset.

²Maximum SPL is measured at 1 m using broadband pink noise at maximum output.

³Current rating is 1/8 power.

Frequency response:

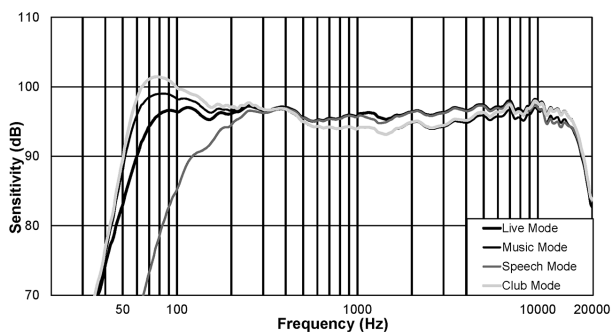

System overview

Full-Range loudspeaker amplifier panel:

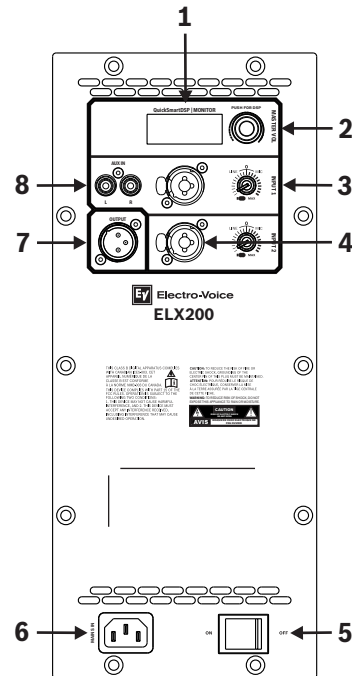

- LCD** - DSP control and monitoring interface.
- MASTER VOL** - Adjusts the sound level.
DSP - Scroll through the menu and select the available choices. Push the MASTER VOL knob to enter the DSP menu.
- INPUT LEVEL** - Level control for adjusting the individual inputs' level. The 12 o'clock position is unity gain (no gain or attenuation), the range to the left of zero (0) is for adjusting line level sources, and the range to the right of zero (0) is for adjusting microphone levels. LINE and MIC input level control is available for both INPUT 1 and INPUT 2.
- INPUT** - Balanced input for the connection of signal sources like mixing consoles, instruments, or microphones. Connections can be established using ¼ inch TRS or XLR connectors.
- POWER** - AC switch for switching the power ON or OFF. The LCD screen lights up when the power is turned ON, after approximately 3 seconds.
- MAINS IN** - AC connection is established via an IEC-connector.
- OUTPUT** - XLR output sends the mix of both input signals to another loudspeaker or subwoofer. INPUT LEVEL controls the signal level to OUTPUT. The MASTER VOL or DSP control settings do not affect OUTPUT.
- AUX INPUT** - Stereo unbalanced RCA inputs for connecting external audio media devices, such as MP3 players. Both RCA inputs are summed and can be controlled with INPUT 1 level. The inputs can be used simultaneously with XLR/TRS INPUT 1.

For more information, see ELX200 Powered Loudspeakers Installation manual (F.01U.326.891).

Dimensions:

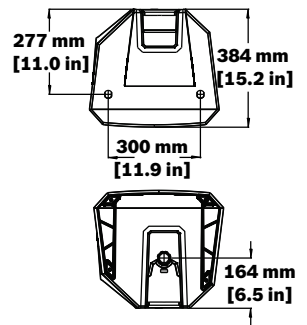
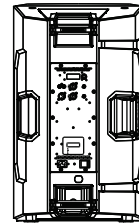
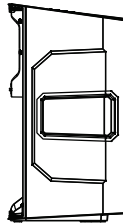
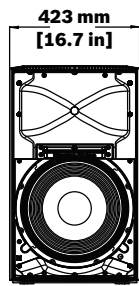
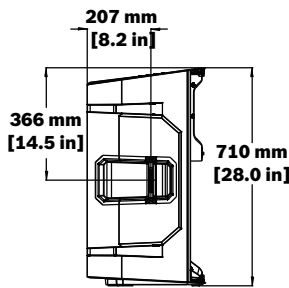

Caution!

Electro-Voice loudspeakers and rigging accessories should be suspended overhead only in accordance with the procedures and limitations specified in the user documentation and installation manual. Electro-Voice products should be suspended with certified rigging hardware by an authorized rigging professional and in complete compliance with local, state, and federal overhead suspension ordinances.



ELX200-15P-W 15" 2-way powered speaker, white
 15" 2-way powered speaker, white
 Order number **ELX200-15P-W**

Accessories

EBK1-M10-3PACK Forged M10 3Pack Short Shank Eyebolt Kit
 Forged M10 short shank eyebolt kit for ELX10/10P, ELX 12/12P, and ELX 15/15P, 3-pack, silver
 Order number **EBK1-M10-3PACK**

ELX200-15-CVR Padded cover for ELX200-15, 15P
 Padded cover for ELX200-15/15P, black
 Order number **ELX200-15-CVR**

ELX200-BRKT Wall mount bracket, ELX200 2-way models
 Wall mount bracket for all ELX200 full-range models, black
 Order number **ELX200-BRKT**

ELX200-BRKT-W Wall mount bracket, ELX200 2-way, white
 Wall mount bracket for all ELX200 full-range models, white
 Order number **ELX200-BRKT-W**

Ordering information

ELX200-15P-US 15" 2-Way powered speaker, US cord
 Powered 15 inch 2-way loudspeaker US cord, black
 Order number **ELX200-15P-US**

ELX200-15P-EU 15" 2-Way powered speaker, EU cord
 Powered 15-inch 2-way loudspeaker EU cord, black
 Order number **ELX200-15P-EU**

ELX200-15P-AP 15" 2-Way powered speaker, AP
 Powered 15-inch 2-way loudspeaker Asia-Pacific regions, black
 Order number **ELX200-15P-AP**

ELX200-15P-GL 15" 2-way powered speaker, Global, No BT
 Powered 15 inch 2-way loudspeaker, two cords, No Bluetooth®, black
 Order number **ELX200-15P-GL**

Represented by:

Germany:
 Bosch Sicherheitssysteme GmbH
 Robert-Bosch-Ring 5
 85630 Grasbrunn
 Germany

Bosch Security Systems, Inc.
 12000 Portland Avenue South
 Burnsville MN 55337
 USA

www.electrovoice.com