

TTL 33-A II

ACTIVE THREE-WAY LINE ARRAY MODULE

DESCRIPTION

The TTL33-A is a compact, wide dispersion, 3 way active line array module that offers the highest performance from a small size line array.

The incredible high output and dynamics, the extreme accuracy and high frequency extension plus the compact size makes the TTL33-A the ideal tool for outdoor sound reinforcement, live performances and events as well as fixed installations in theatres, concert halls or auditoriums.

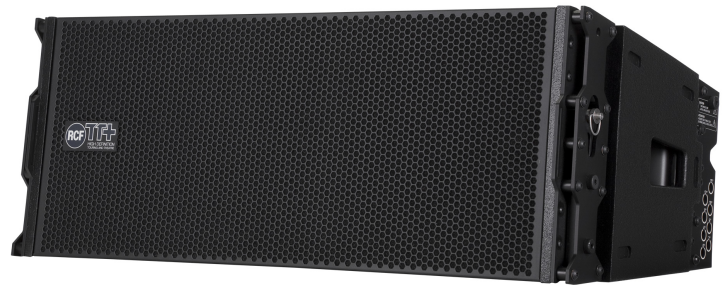

FEATURES

- 1250 W switching amplifiers
- wide, constant directivity, coverage angle
- 6 high power neodymium transducers
- High quality analog input board
- 96 kHz, 32 bit DSP processing
- Soft limiter and RMS protection
- Maximum output per size available on the market
- RDNet on board

TECHNICAL SPECIFICATIONS

Acoustical specifications	Frequency Response:	60 Hz ÷ 20000 Hz
	Max SPL @ 1m:	135 dB
	Horizontal coverage angle:	100°
	Vertical coverage angle:	15°
Transducers	Compression Driver:	3 x 1.0" neo, 1.5" v.c
	Midrange:	8" neo, 2.0" v.c
	Woofers:	2 x 8" neo, 2.5" v.c
Input/Output section	Input signal:	bal/unbal
	Input connectors:	XLR, RDNet Ethercon
	Output connectors:	XLR, RDNet Ethercon
	Input sensitivity:	-2 dBu/+4 dBu
Processor section	Crossover Frequencies:	400 Hz - 1800 Hz
	Protections:	Thermal, HF
	Limiter:	Fast Limiter
	Controls:	HF Correction, cluster size, HPF
	RDNet:	Yes
Power section	Total Power:	2500 W Peak, 1250 W RMS
	High frequencies:	500 W Peak, 250 W RMS
	Mid frequencies:	1000 W Peak, 500 W RMS
	Low frequencies:	1000 W Peak, 500 W RMS
	Cooling:	Convection/Forced
	Connections:	Powercon IN/OUT
Standard compliance	CE marking:	Yes
Physical specifications	Cabinet/Case Material:	Baltic birch plywood
	Hardware:	Array side fittings
	Handles:	2 on side
	Grille:	Steel
	Color:	Black
Size	Height:	290 mm / 11.42 inches
	Width:	760 mm / 29.92 inches
	Depth:	441 mm / 17.36 inches
	Weight:	33 kg / 72.75 lbs
Shipping informations	Package Height:	395 mm / 15.55 inches
	Package Width:	875 mm / 34.45 inches
	Package Depth:	545 mm / 21.46 inches
	Package Weight:	37 kg / 81.57 lbs



PART NUMBER

• **13000361**

TTL 33-A II

115V

EAN 8024530009748

• **13000360**

TTL 33-A II

220-240V

EAN 8024530009731

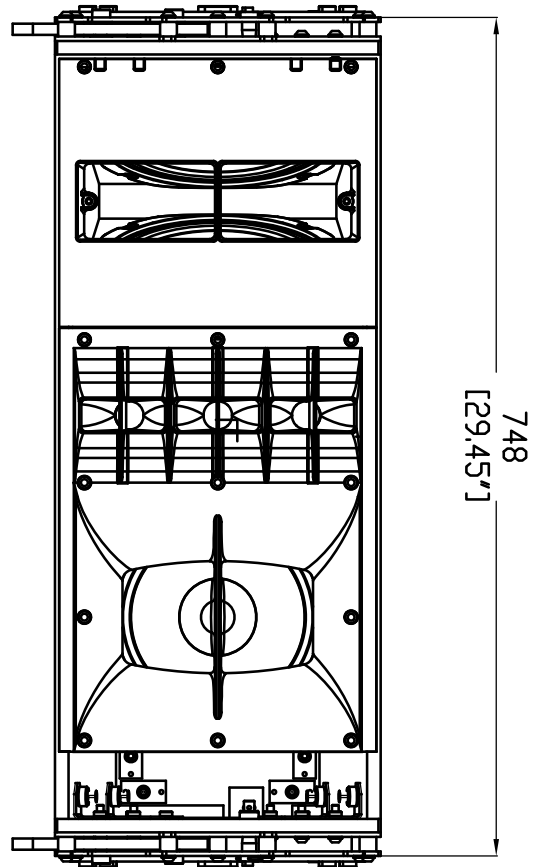
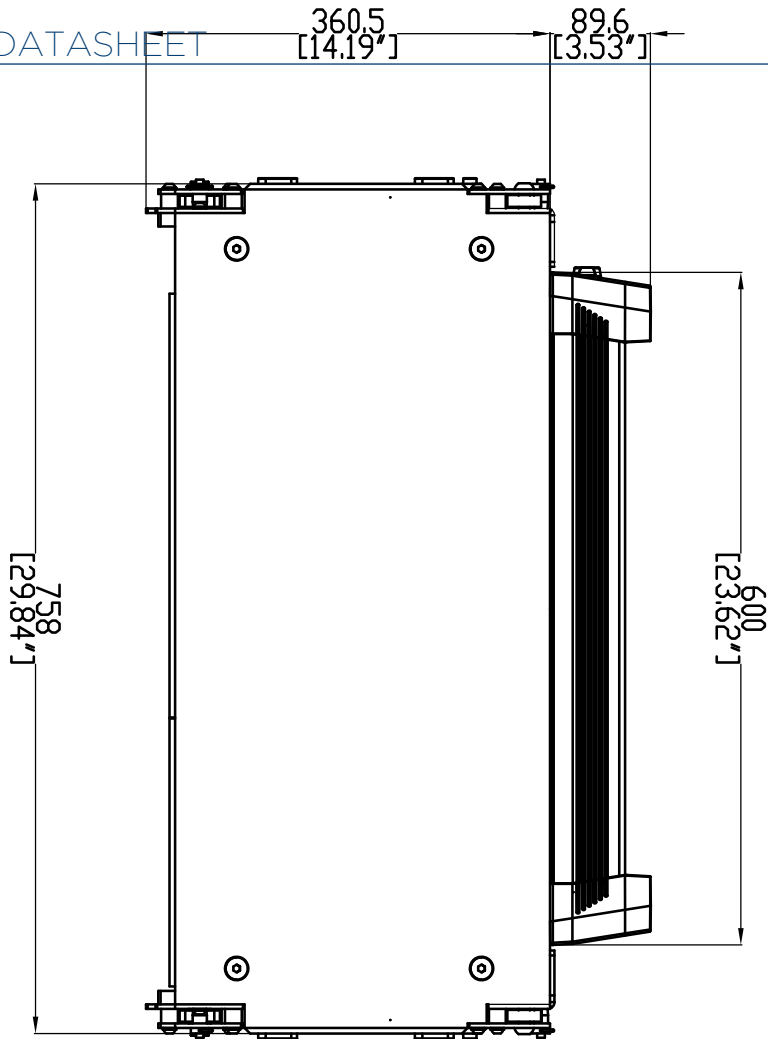

TT33-A

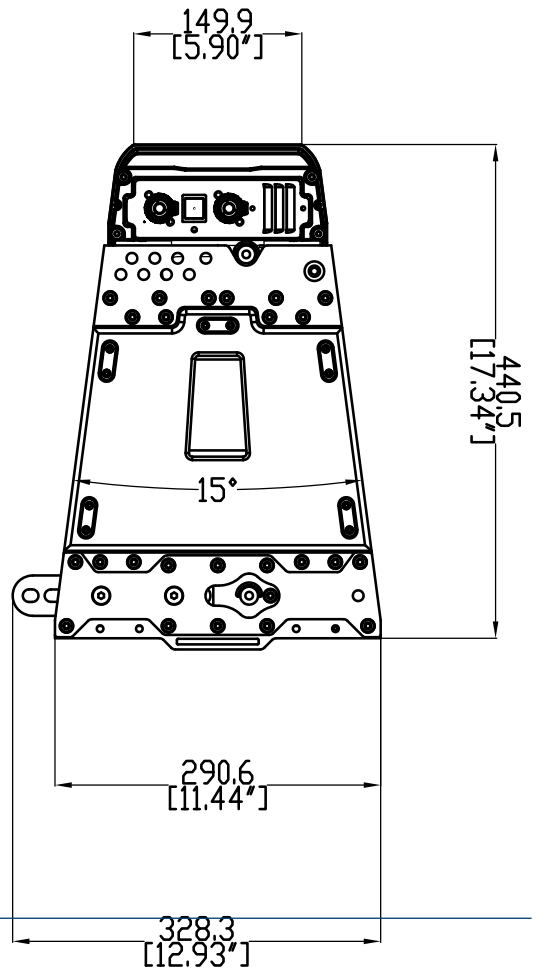

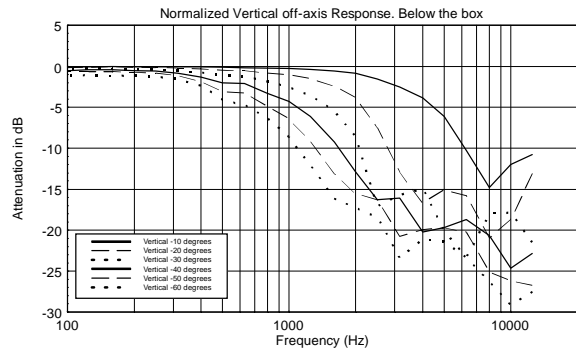
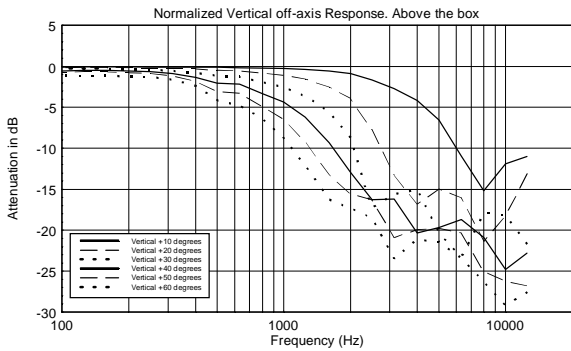
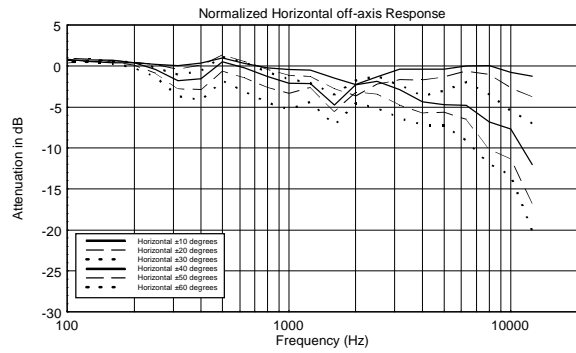
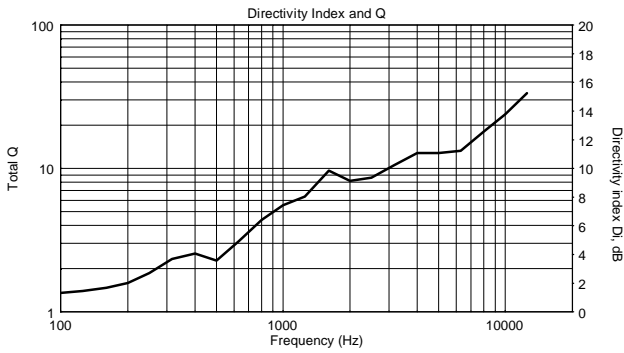
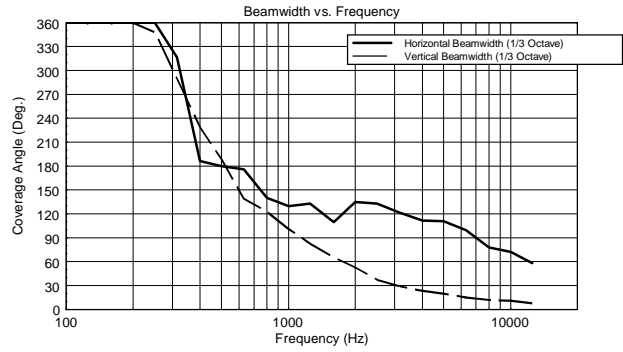
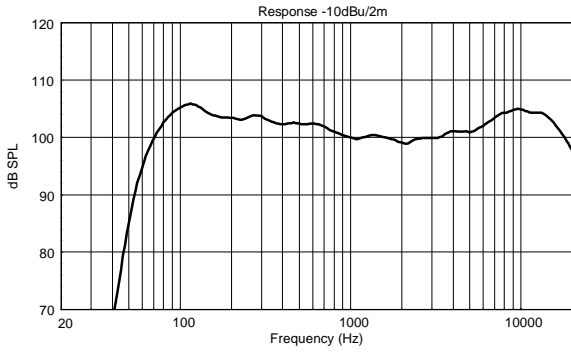

Horizontal 1/3 Octave Polars

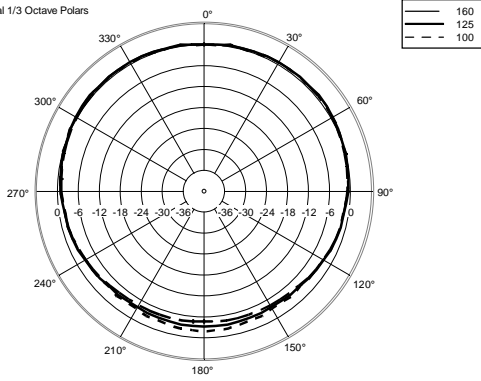

Horizontal 1/3 Octave Polars

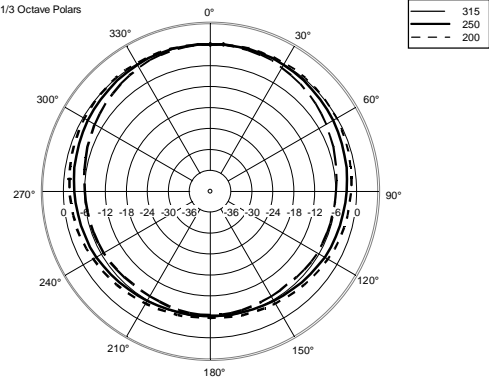

Horizontal 1/3 Octave Polars

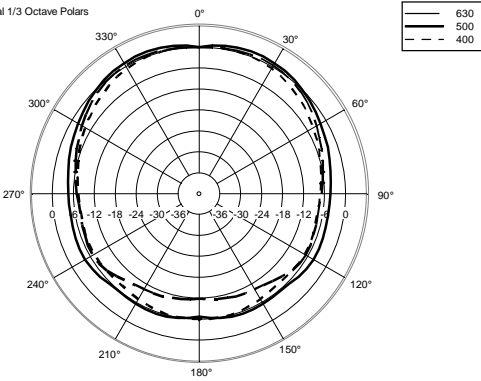

Horizontal 1/3 Octave Polars

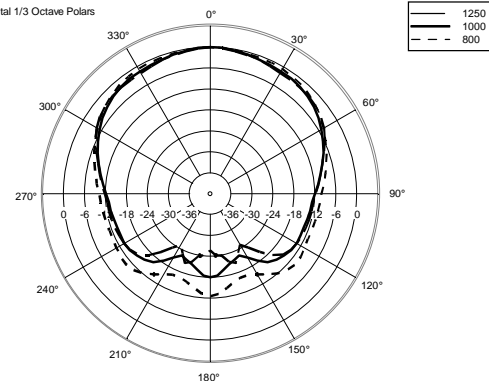

Horizontal 1/3 Octave Polars

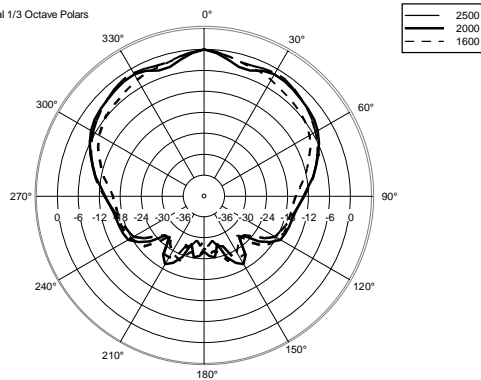

Horizontal 1/3 Octave Polars

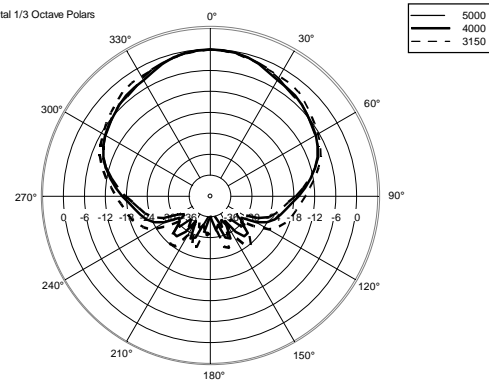

Horizontal 1/3 Octave Polars

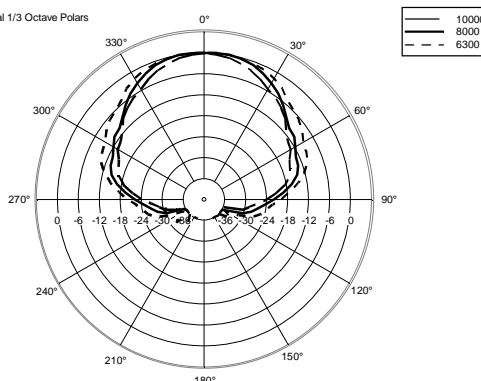

Horizontal One Octave Polars

