

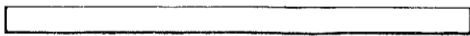

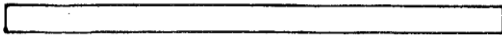

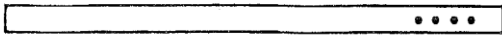



DELLISTE OG OPSTILLINGSVEJLENDNING TIL HN NR. 8330

Antal		
10	A 	Spær ø38mm
12	B 	Forbindelsesstang ø38mm
10	C 	Ben ø38mm
6		3 vejs kryds
9		4 vejs kryds
10		Bundplade til ben
52		Pløk
60		Kuglestrop
4		Bardun
1		Tag
2		Sidevæg
2		Gavlvæg
10		Møtrik og bolt

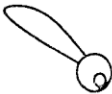
- Mål: 4 x 8 m.
- Farve: Hvid.
- Materiale stel: Stål.
- Materiale tag/sider: Polypropylene.
- Tag: PA 190g/m².
- Sider: PA 170g/m².
- Højde til kip: 3,15 m.
- Højde på side: 2 m.
- Rør: Ø. 38 mm x 1 mm.
- Vægt: 84,5 kg.

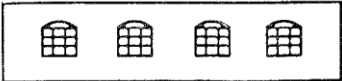
Kassestørrelser:

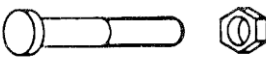
- 1 karton : 2,16 m x 17 cm x 17 cm.
- 1 karton : 1,98 m x 17 cm x 17 cm.
- 1 karton : 57 cm x 18 cm x 46 cm.
- 1 karton : 57 cm x 48 cm x 33 cm.

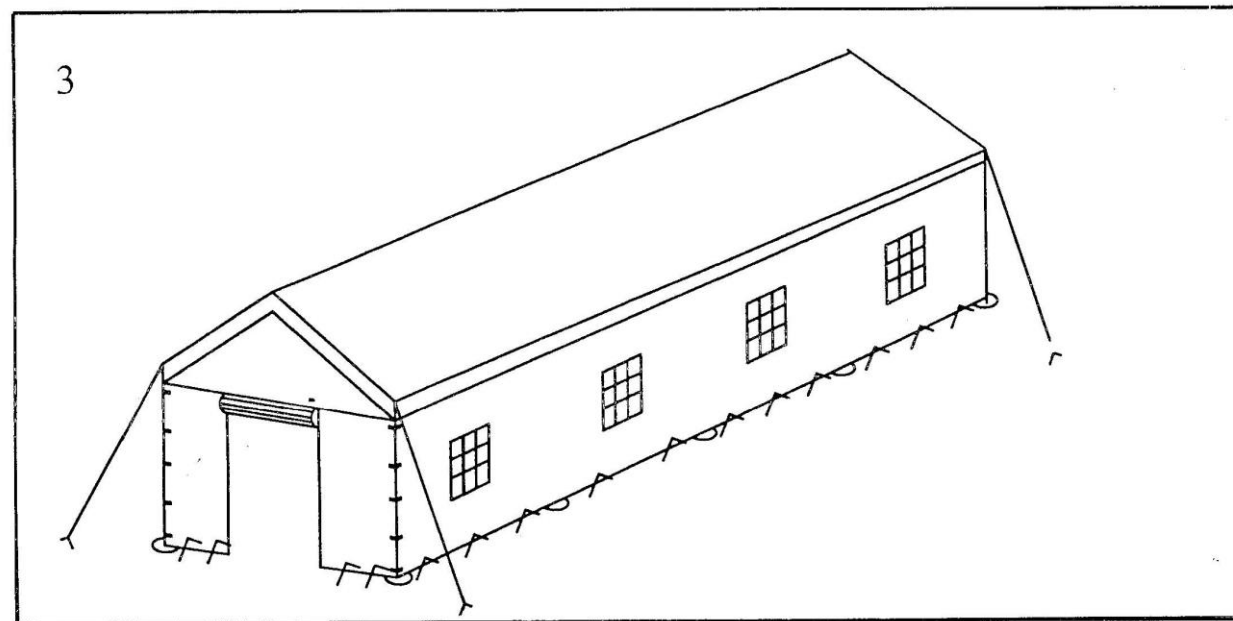
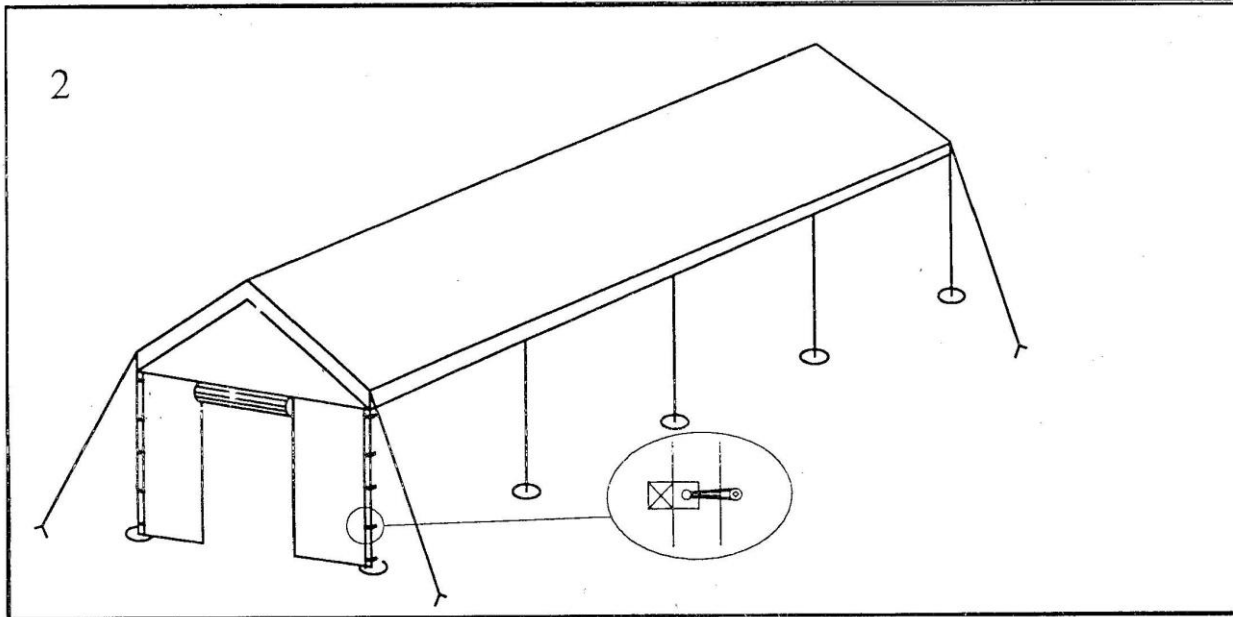
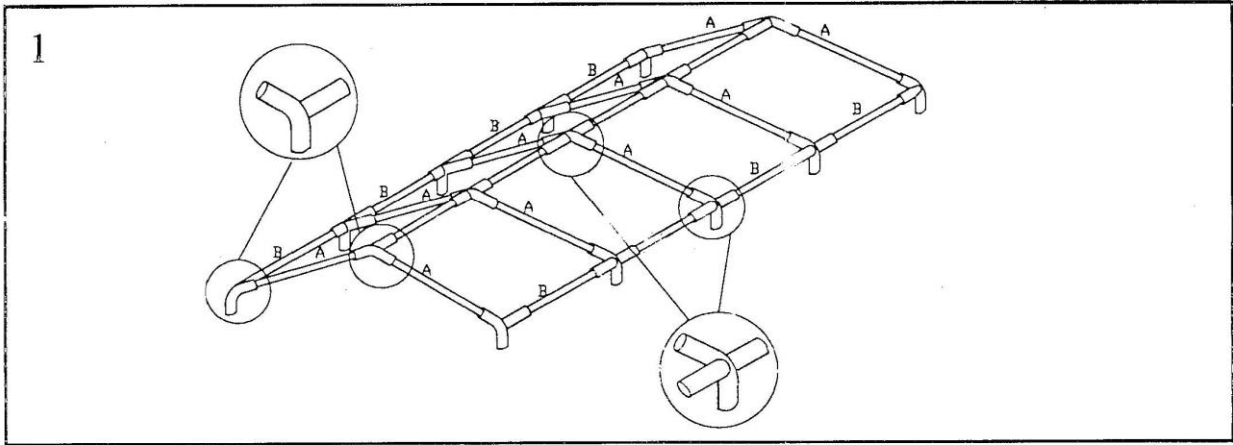

4 X 8 M

I

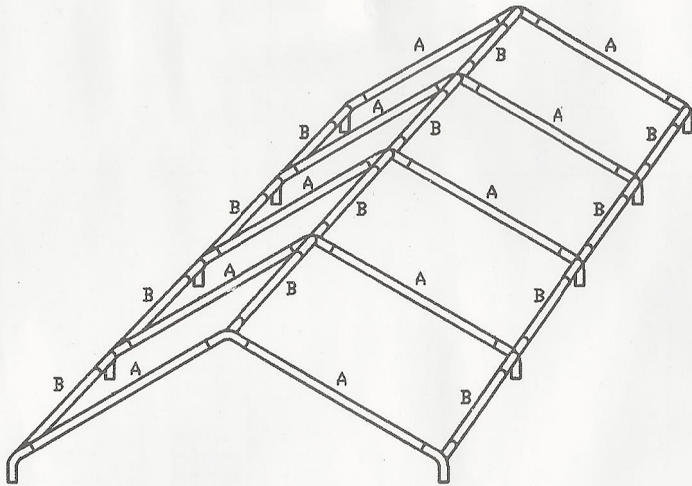

II

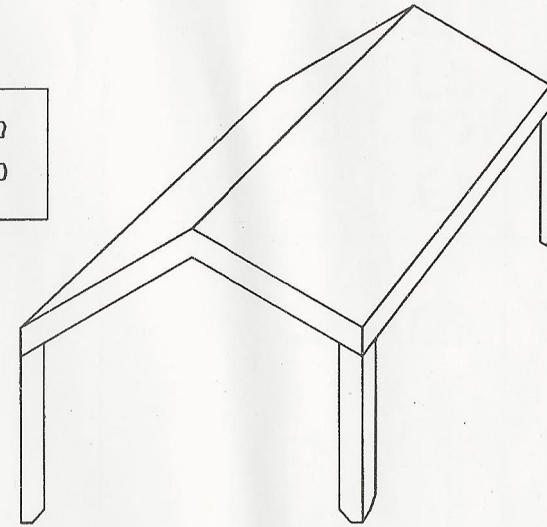
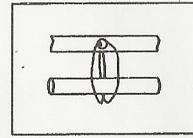

III

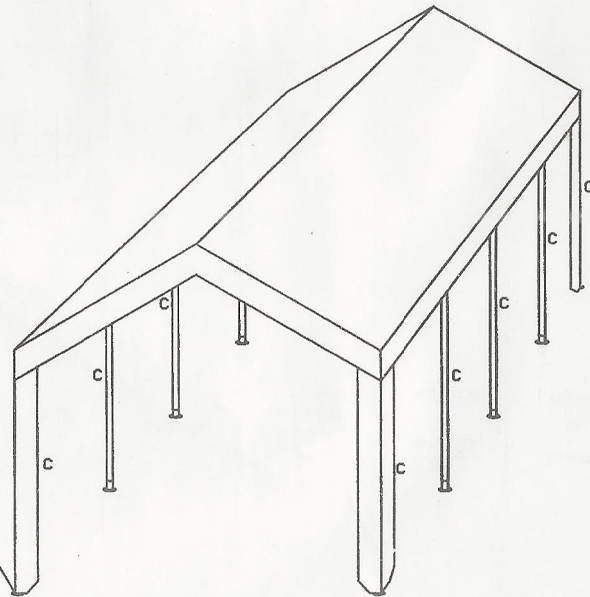
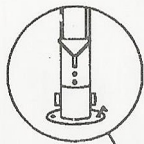



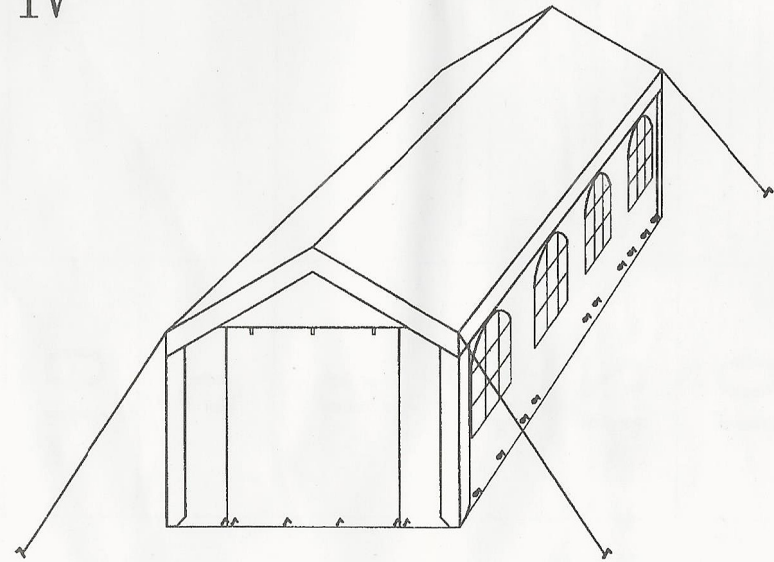





IV

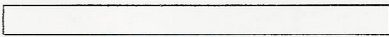
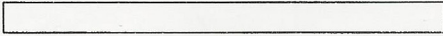
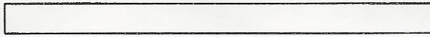

ADVARSEL !!
Efterlad ikke pavillonen opstillet i dårligt vejr. Efterlad den ikke uden opsyn. Anvend ikke unødvendige kræfter for at montere eller demontere den. Tænd ikke bål eller grill under den. Forvis dem altid om, at den er forsvarlig forandret.

HN8330

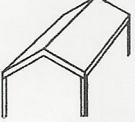
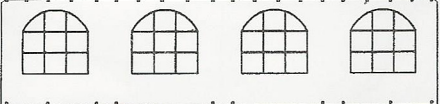
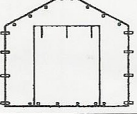
4 X 8 M

10		A	∅ 38mm
12		B	∅ 38mm
10		C	∅ 38mm
6			
9			
10			
14			
44			
4			
1			
2			
2			
60			

ADVARSEL !!

Efterlad ikke pavillonen opslået i dårligt vejr. Efterlad den ikke uden opsyn. Anvend ikke unødvendige kræfter for at montere eller demontere den. Tænd ikke bål eller grill under den. Forvis dem altid om, at den er forsvarlig forandret.