



# Heliga Trefaldighets kyrka i Gävle – Ombyggnad och restaurering

Resultat och konsekvenser i kyrkorum av lokalförsörjningsplaner

Robert Krantz och Jakob Wiklander







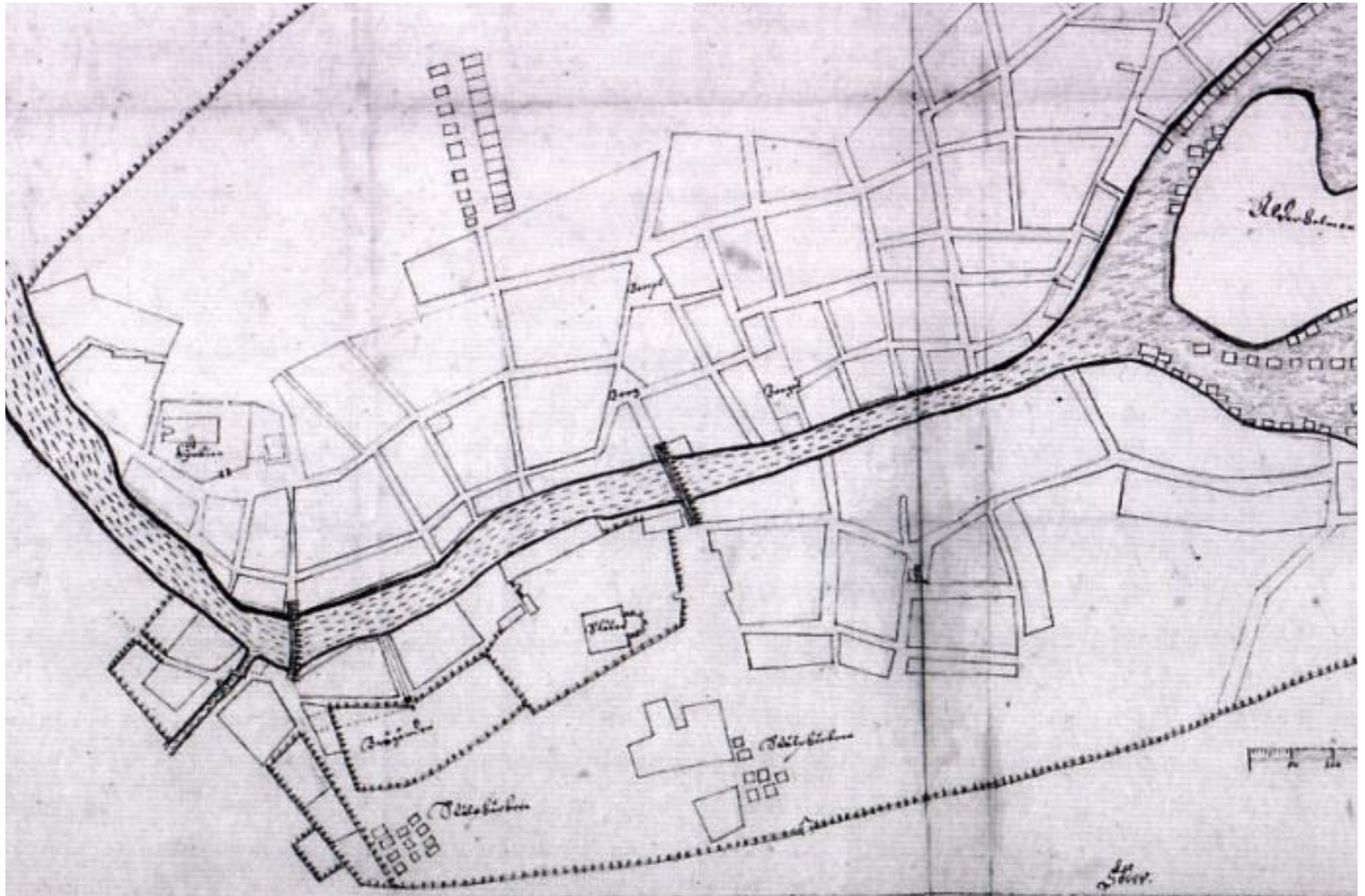

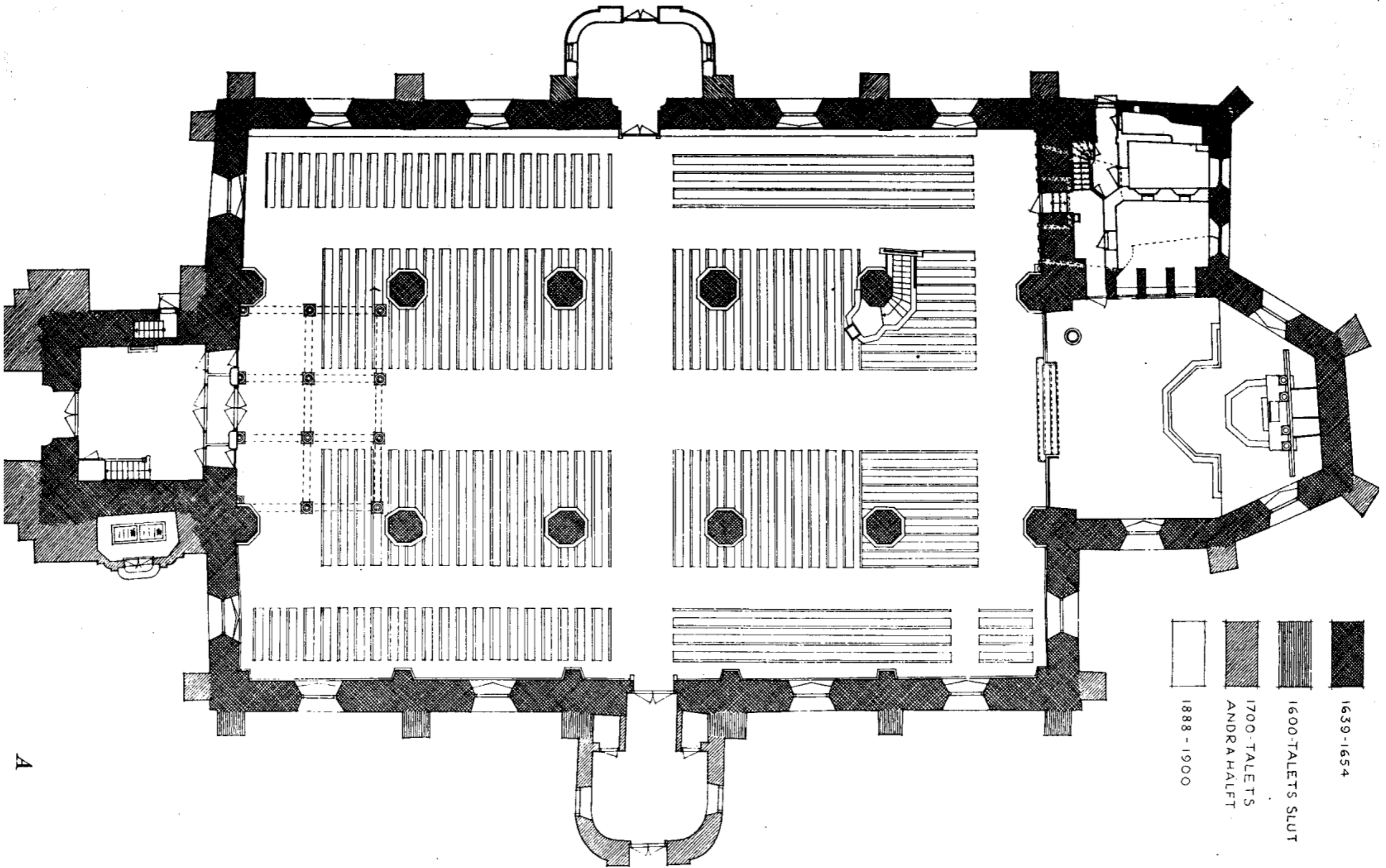

A

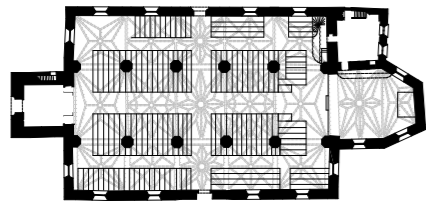

1654

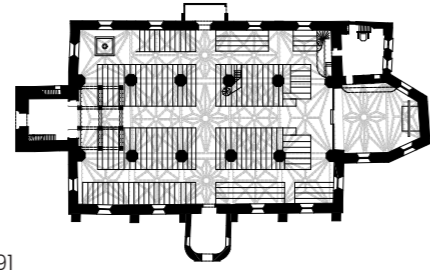

1691

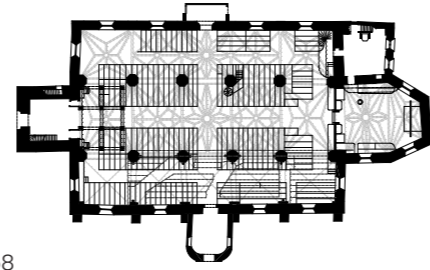

1758

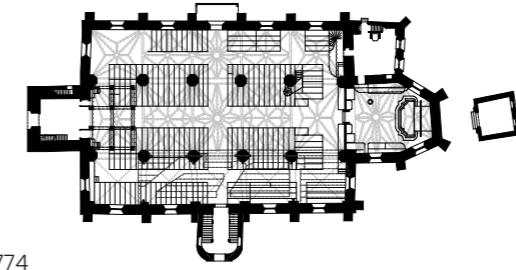

1774

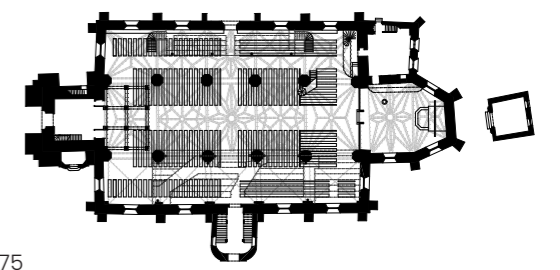

1875

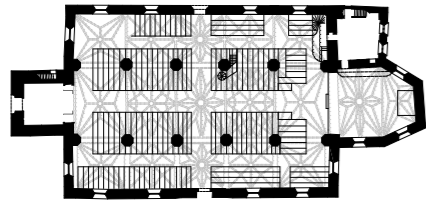

1657

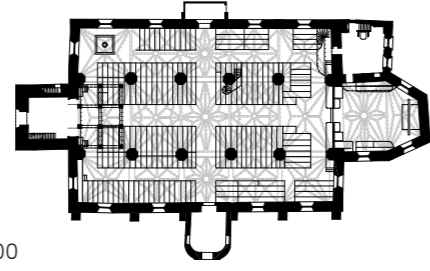

1700

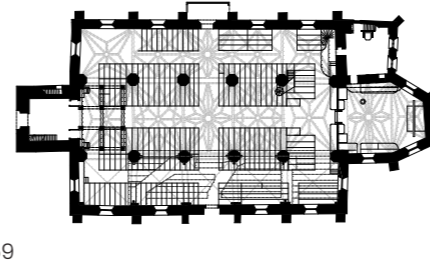

1759

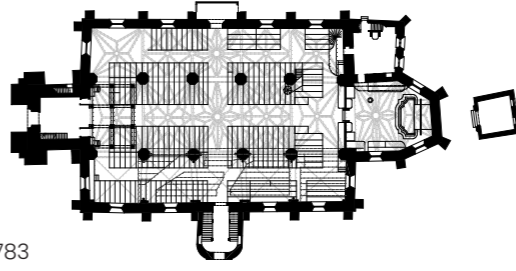

1783

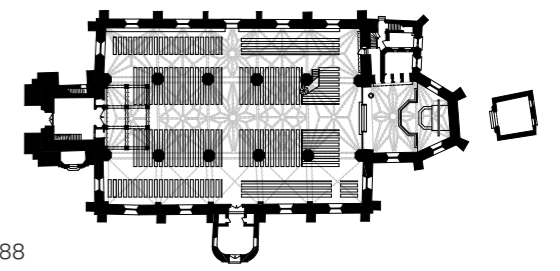

1888

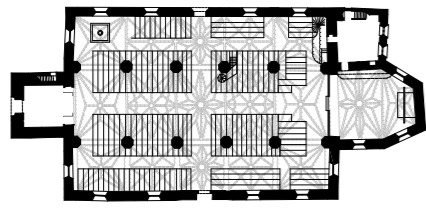

1660

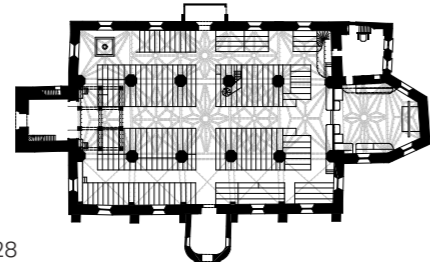

1728

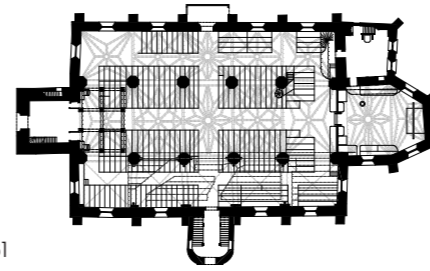

1761

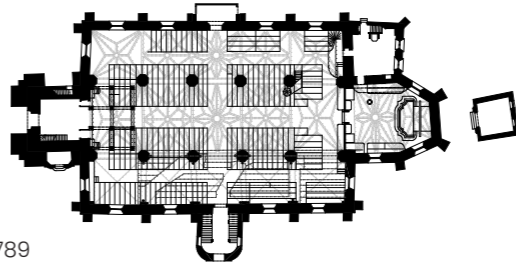

1789

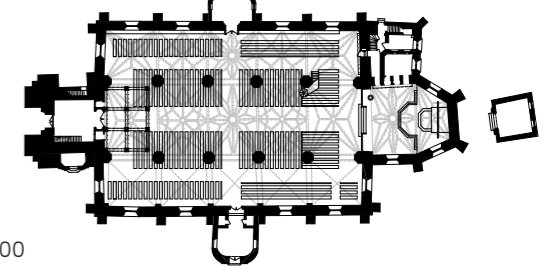

1900

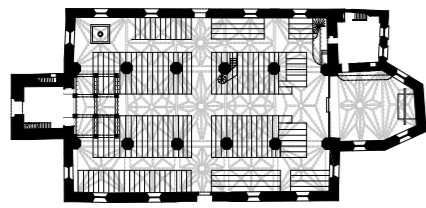

1671

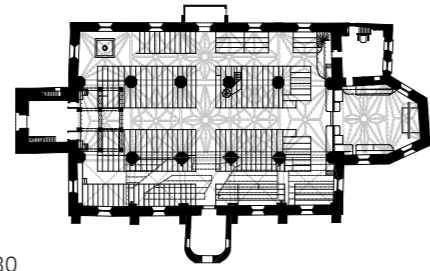

1730

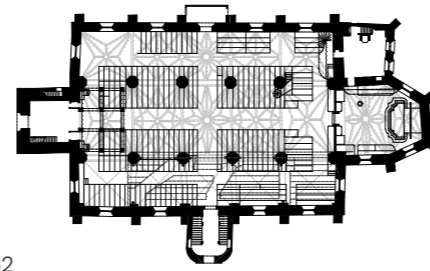

1762

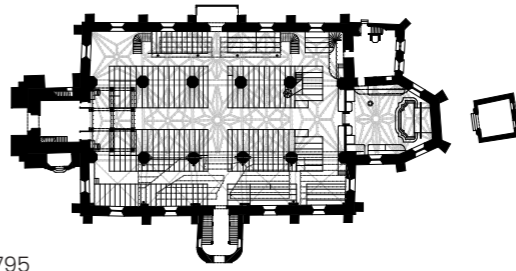

1795

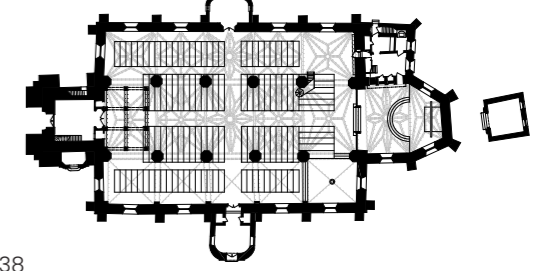

1938

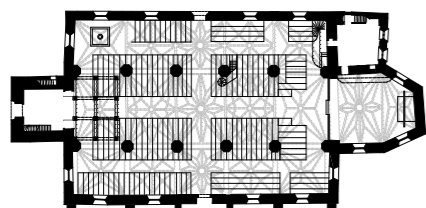

1682

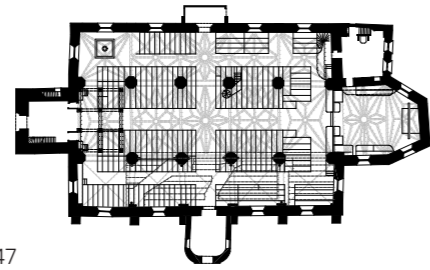

1747

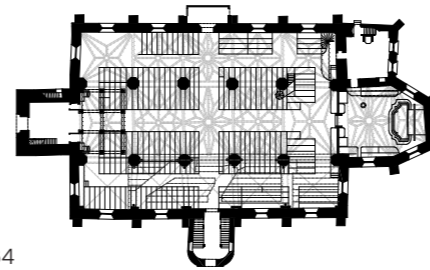

1764

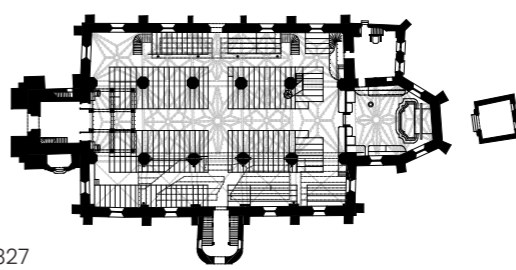

1827

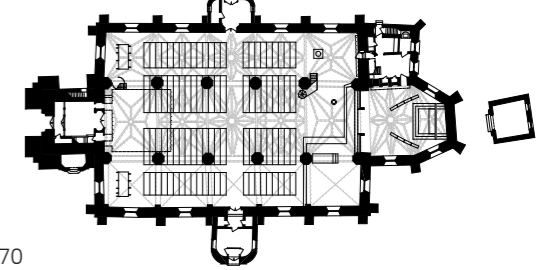

1970

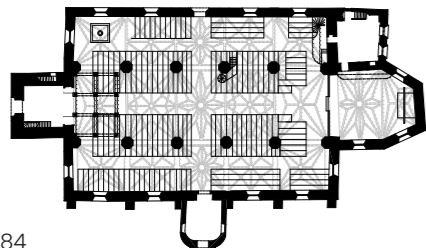

1684

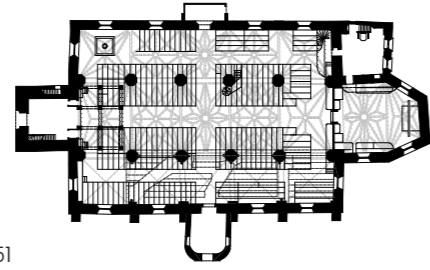

1751

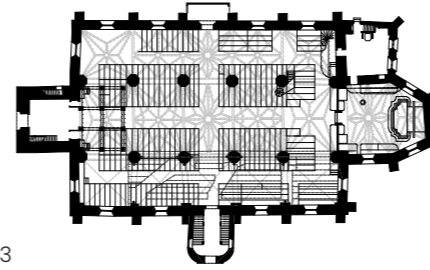

1773

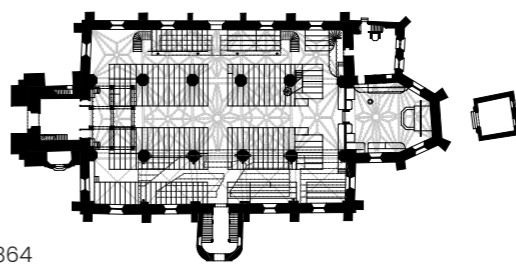

1864

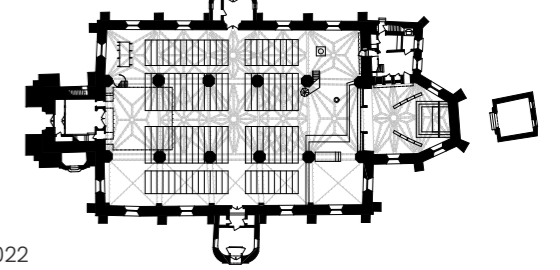

2022

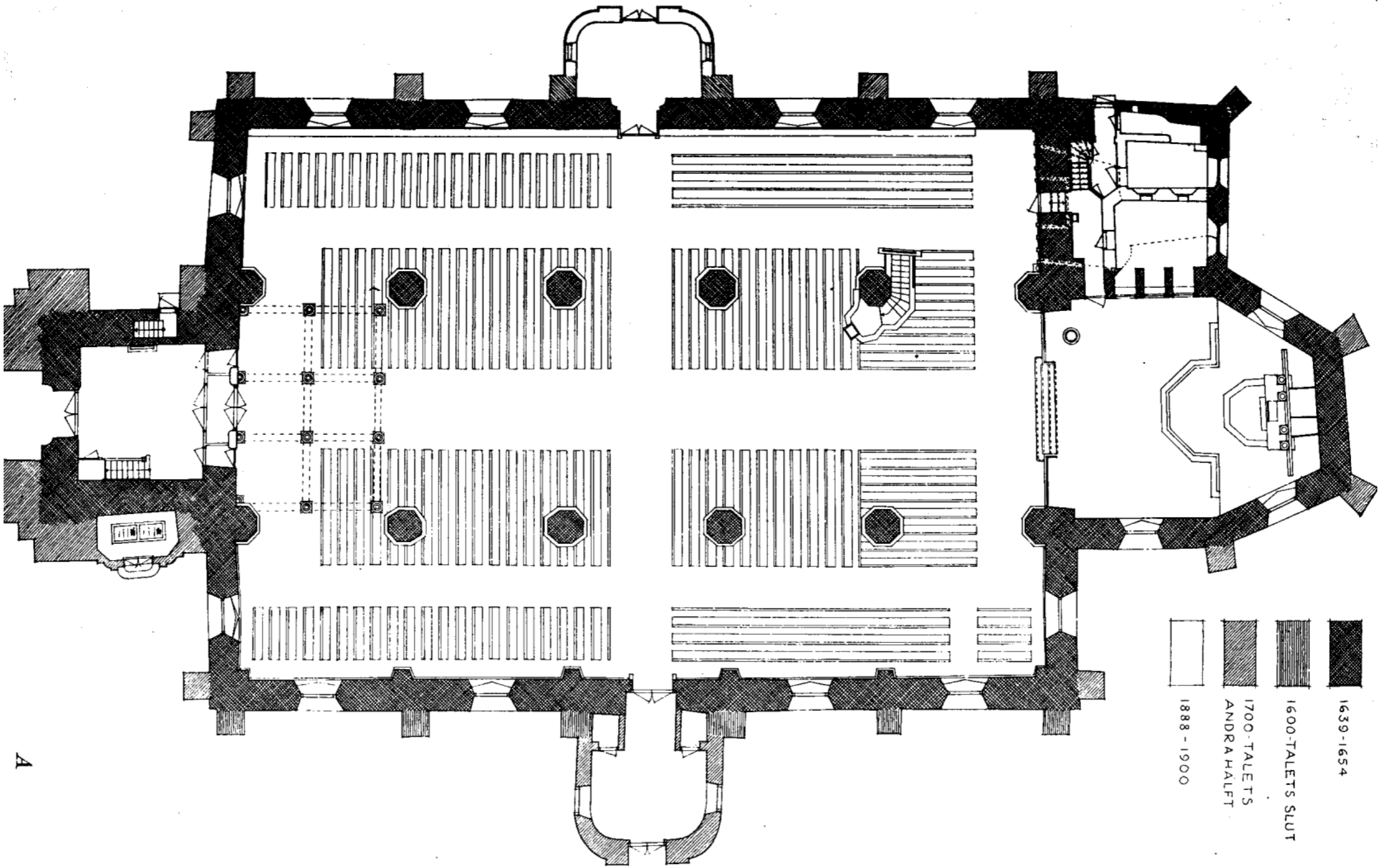

A



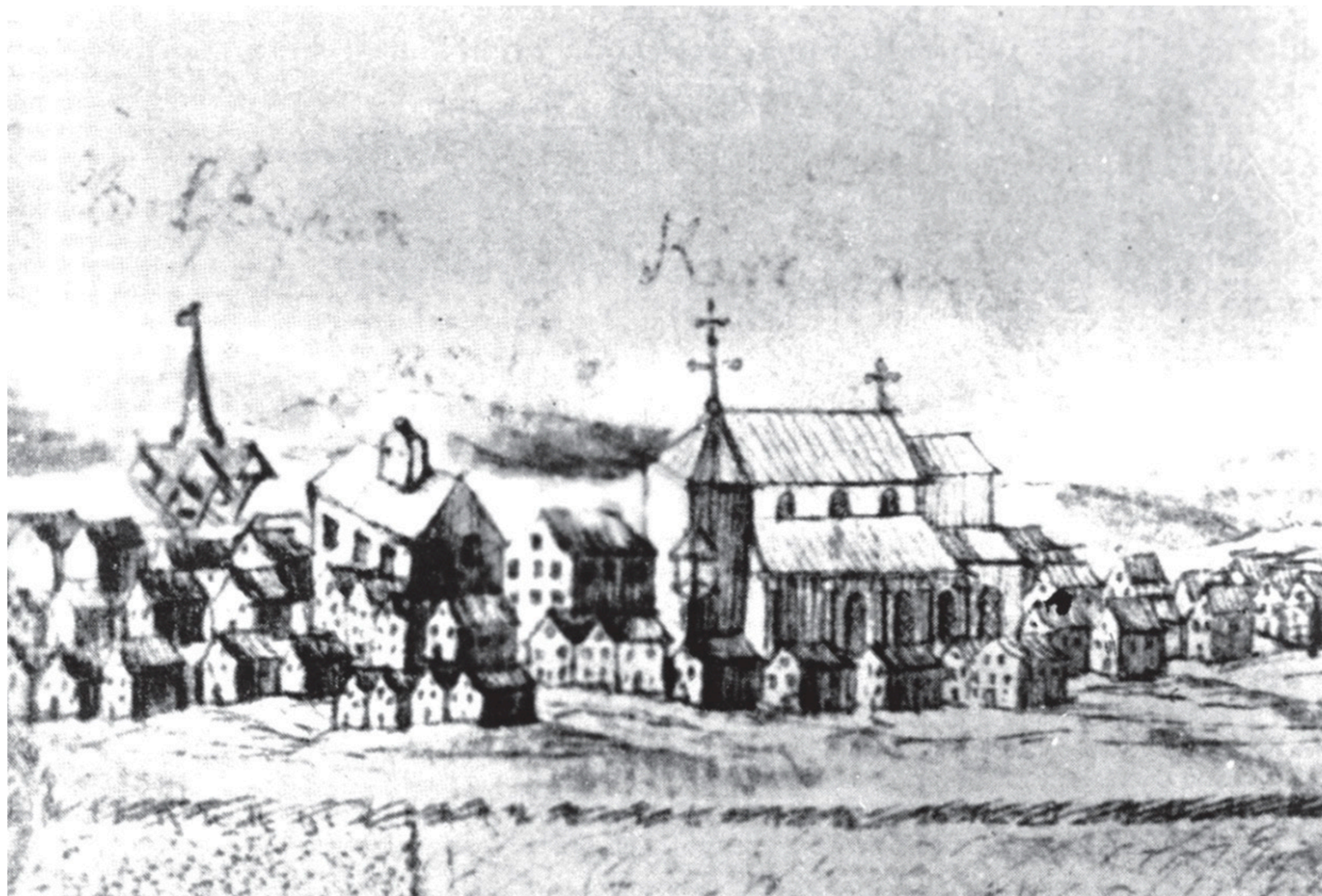

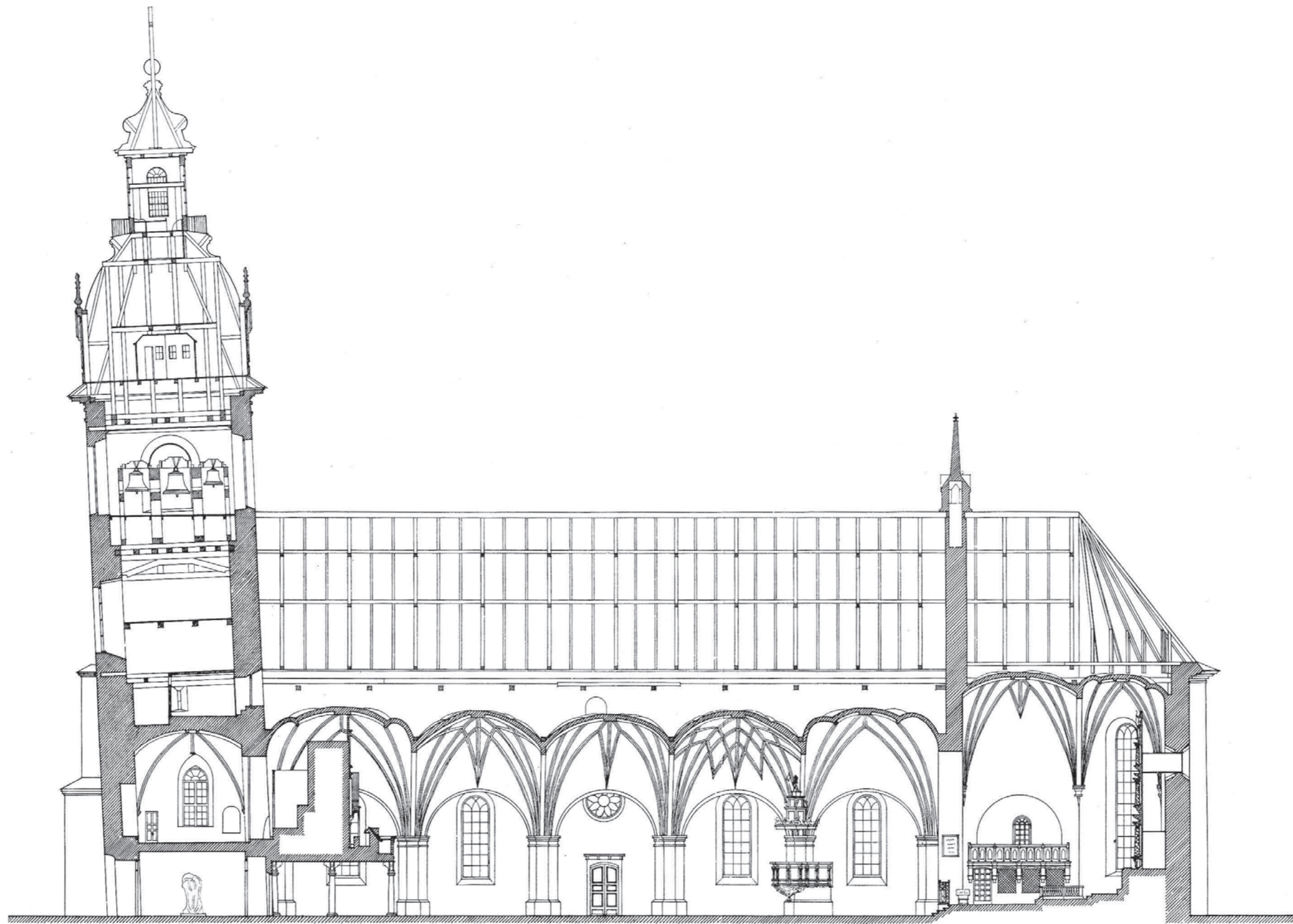

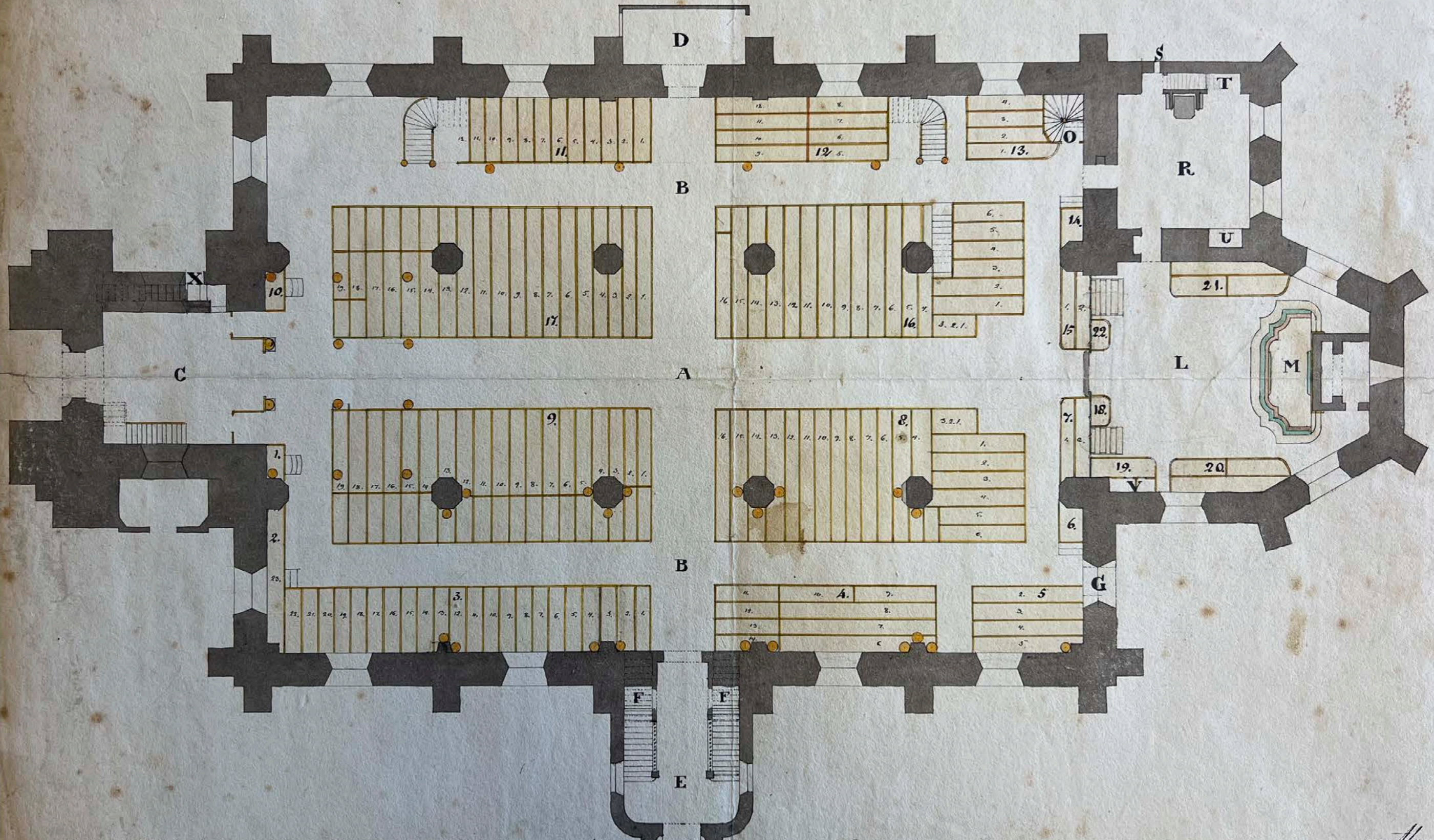

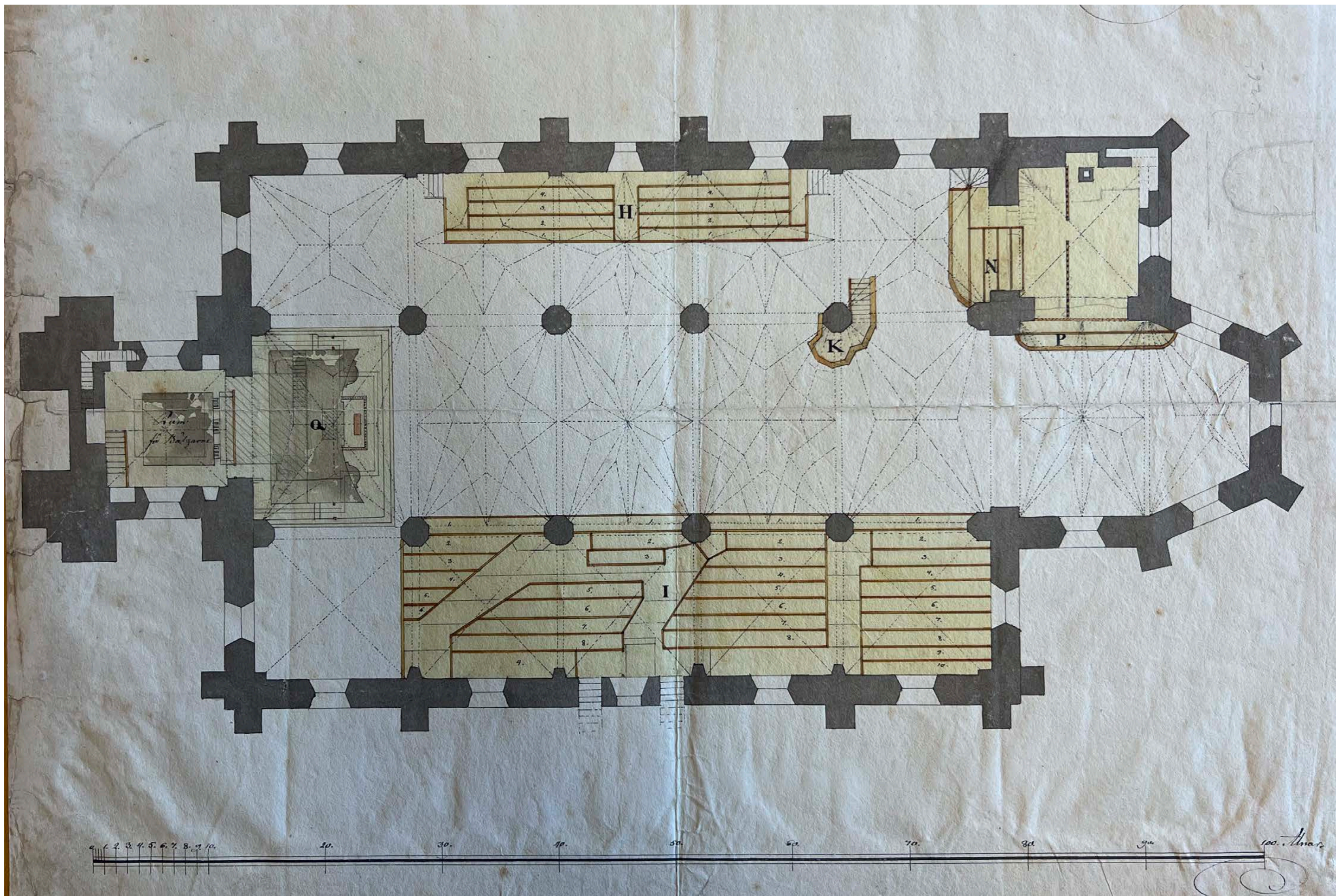

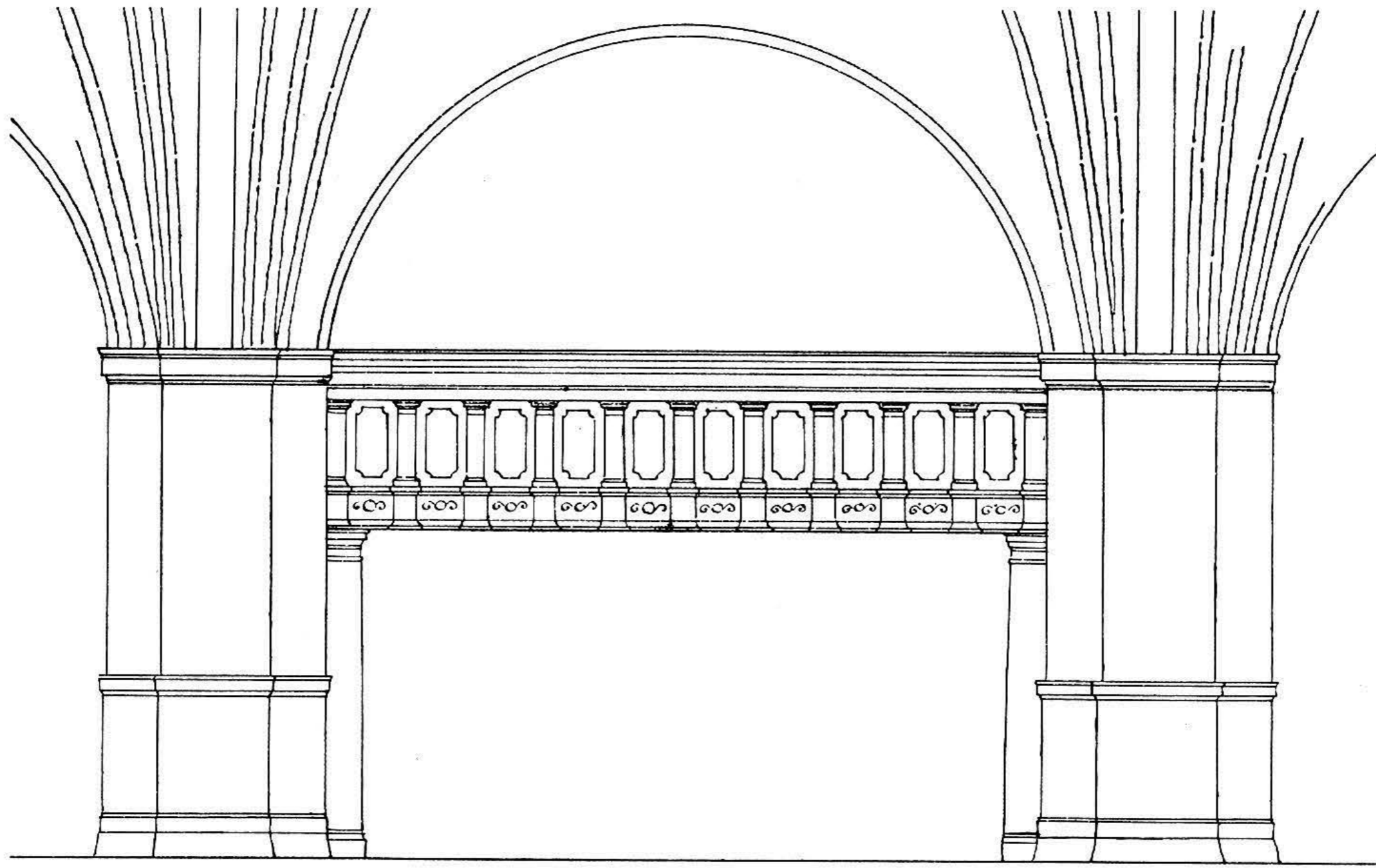









Sjeliga Trefaldighetskyrkan  
i Gefle.

Bil. Litt. D. 14

Tvärsektion visande grundens  
förstärkande och delvis  
nybyggnad.

SÖDRA LÅNGVÄGGEN OMBYGGES FULLSTÄNDIGT. (OBS! TÄTARE STRECKNING.)  
(DEN PRICK-STRECKADE LINIEN VISAR VÄGGENS NUVARANDE UTSEENDE.)

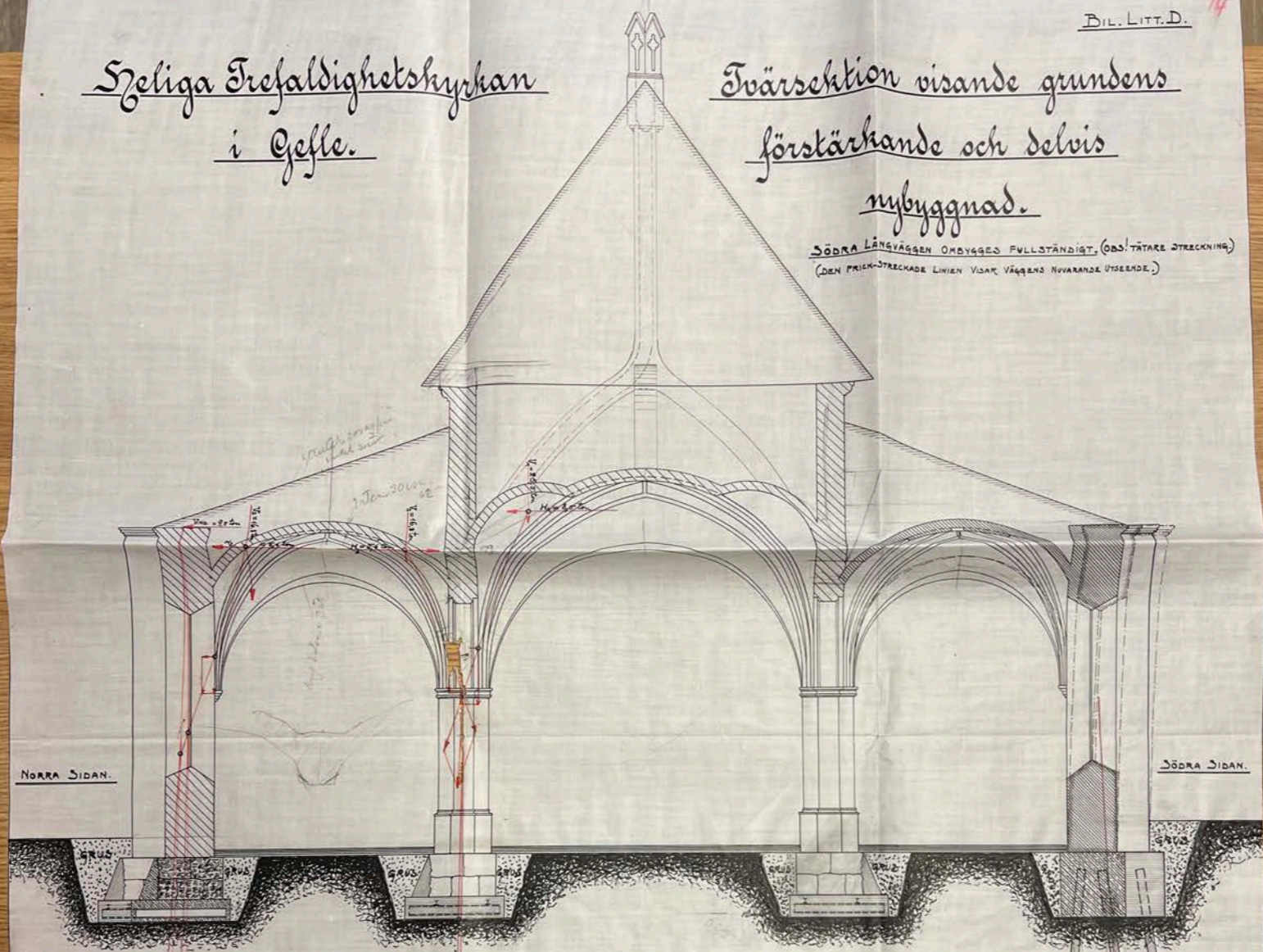

DIMENSIONER Å BETONGULER OCH BALKINLÄGG  
FINNAS ANGIFNA Å EN DÄRSKILD PLANRITNING ÖVER HELA KYRKAN.

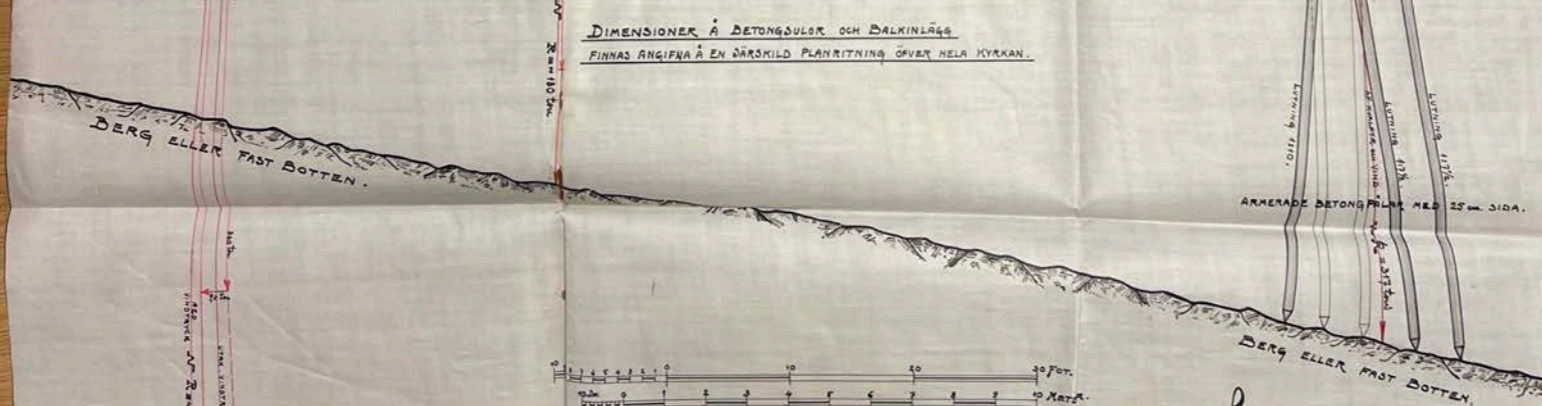

Stockholm i Jan. 1906  
P. Petrusson

OBS! BYGGNADSTOMMEN KOPIERAD ÅTER EN AF STADSARKITEKTEN HEDIN ÅR 1888 TILL  
KUNGL. ÖVERINTENDENTÄMBETET INLÄMNAD RITNING.











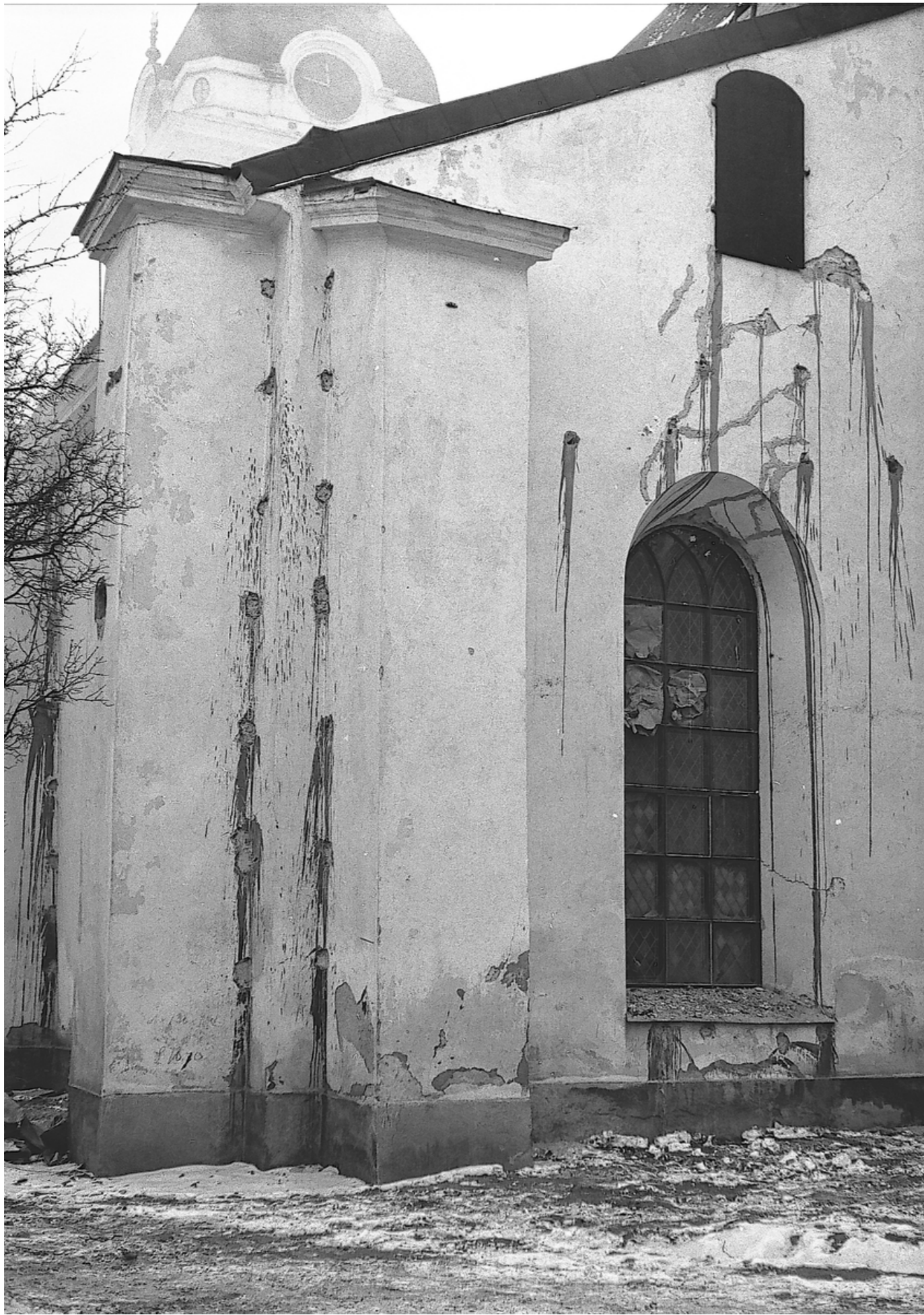









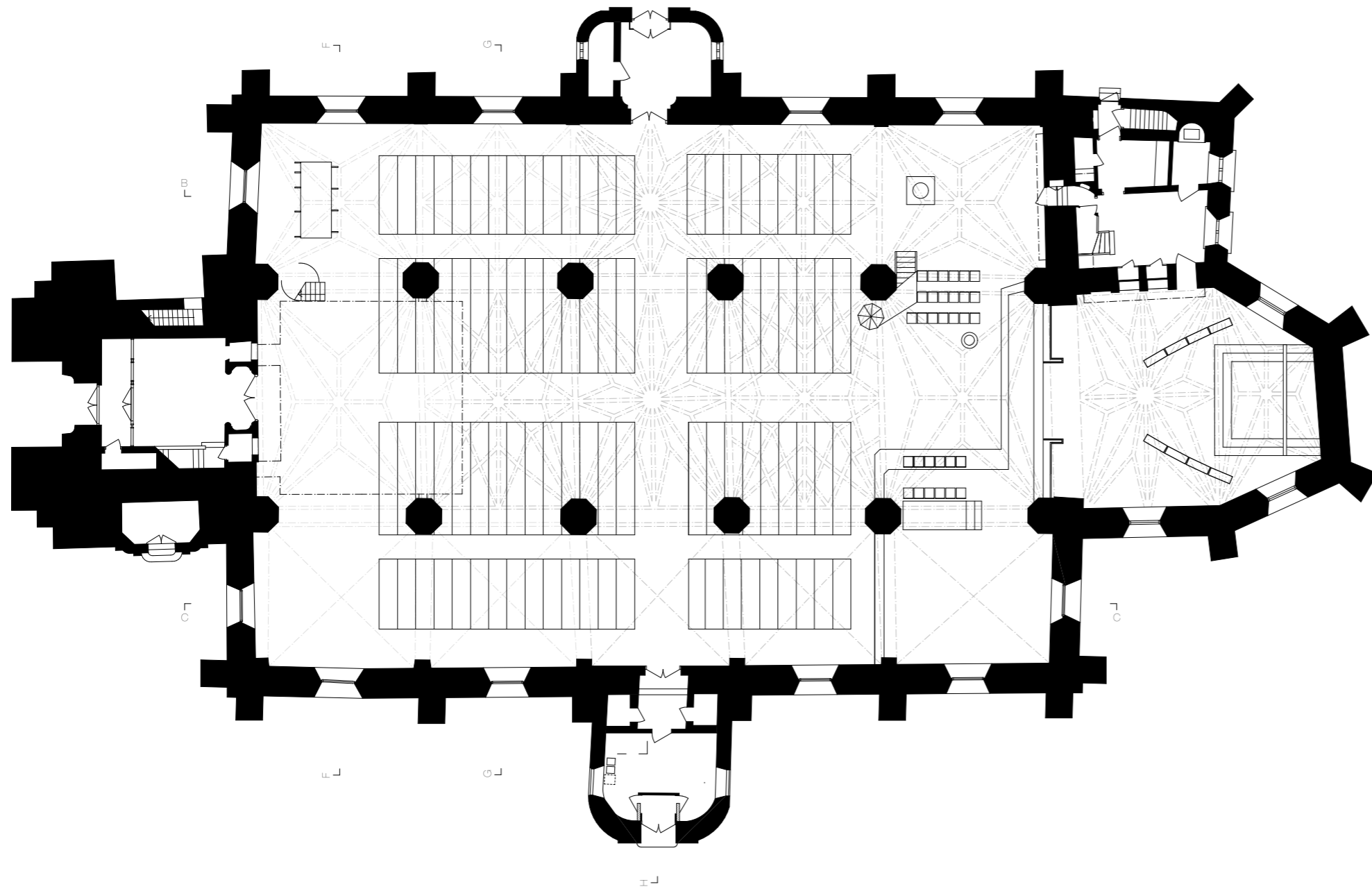

- Parallella verksamheter
- Barn och ungdomar
- Arbetsplatser i kyrkan
- Mötesplats i staden
- Kulturhistoriska inventarier
- Förvaring
- Toaletter
- Belysning och ljudsystem
- Bevara akustiken
- Bevara värdebärare
- Tillgänglighet till koret

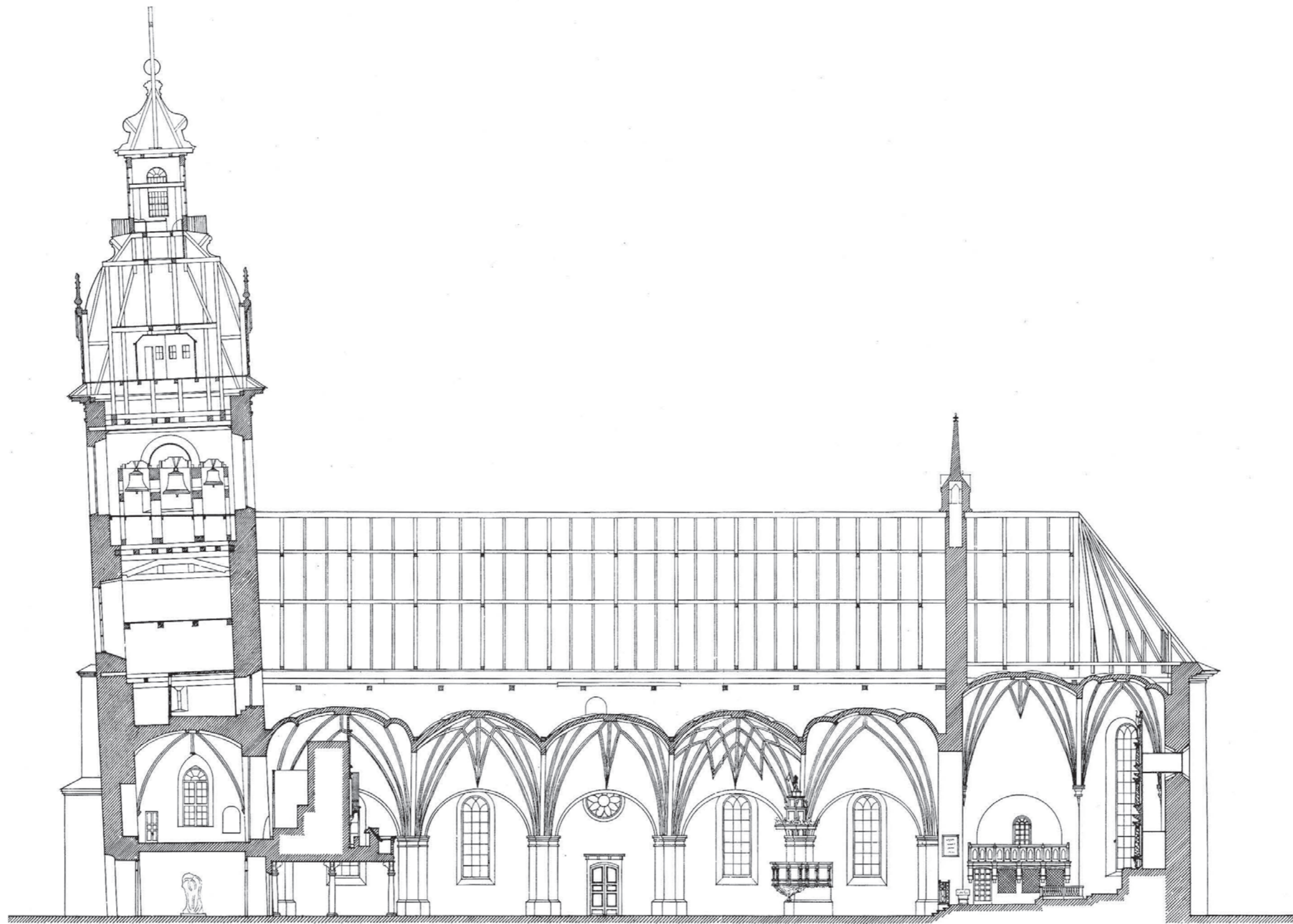





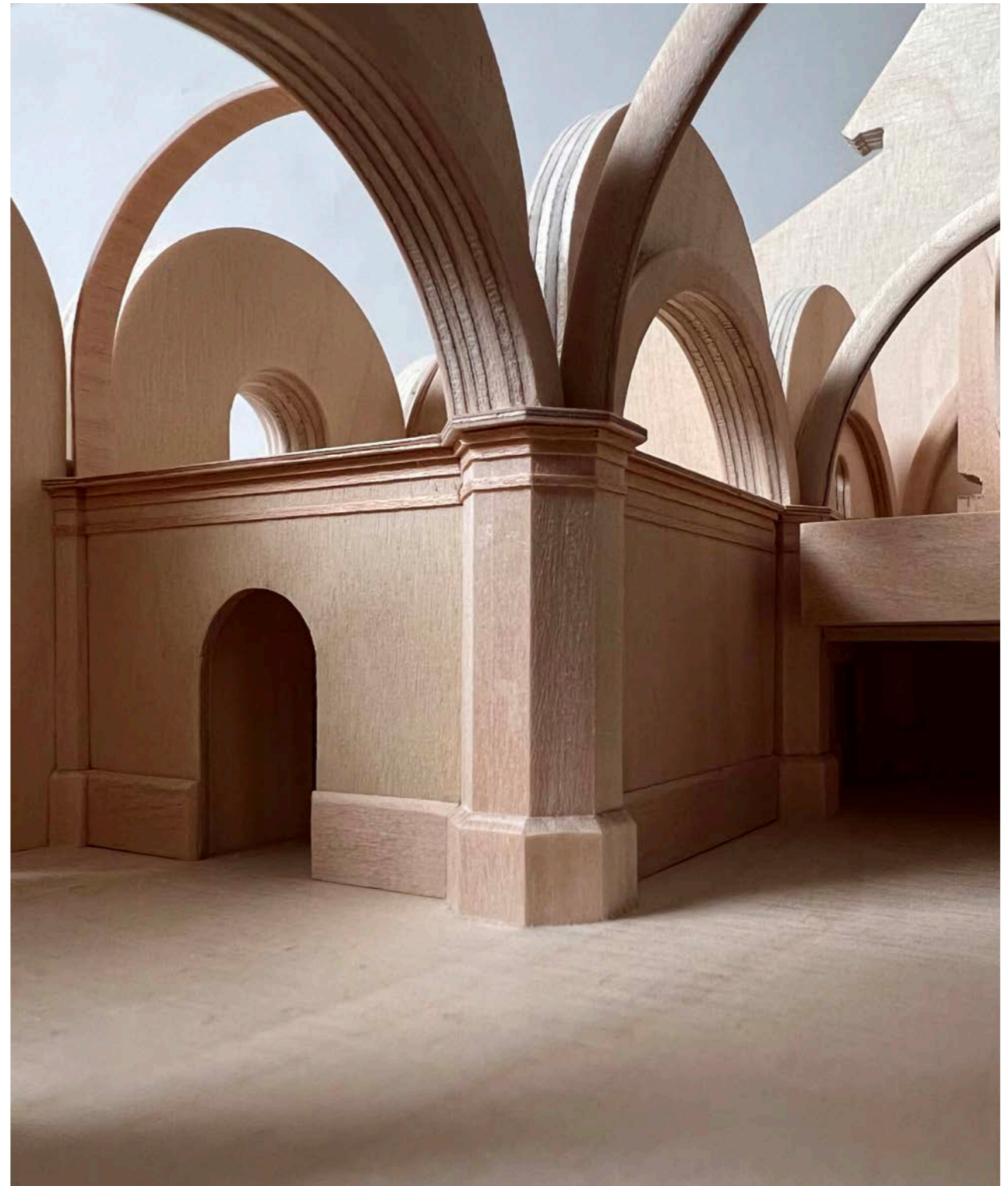
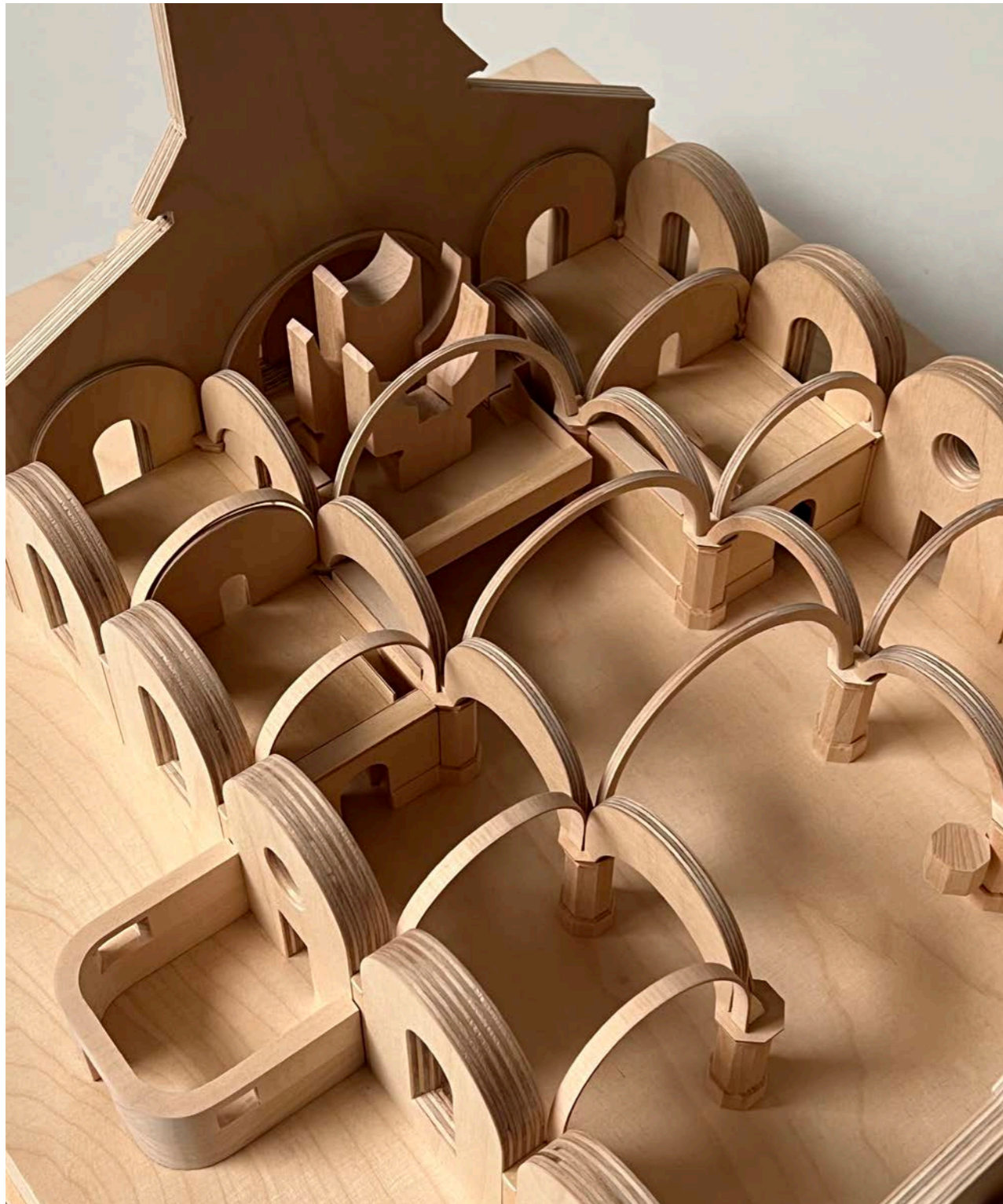

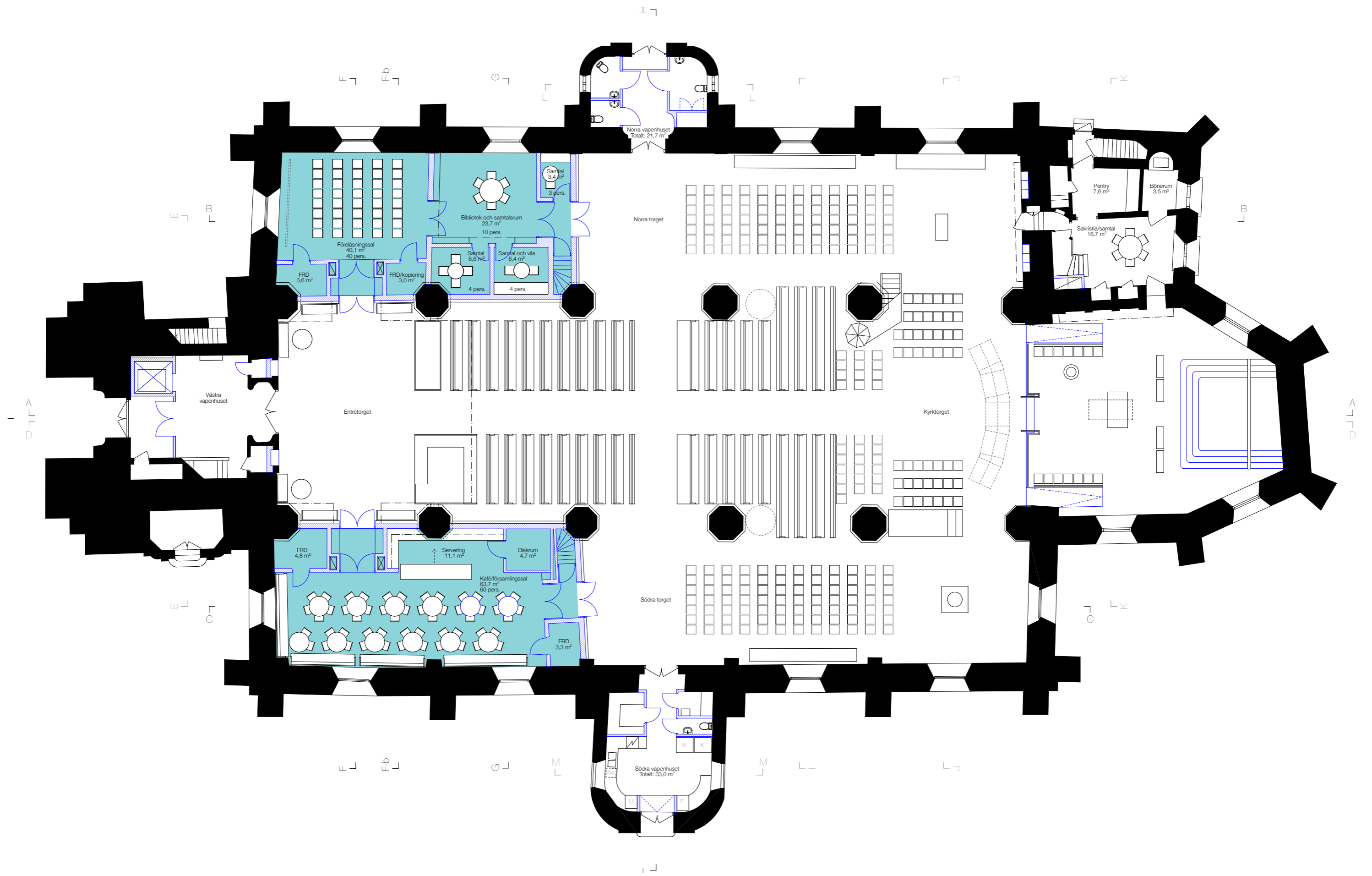



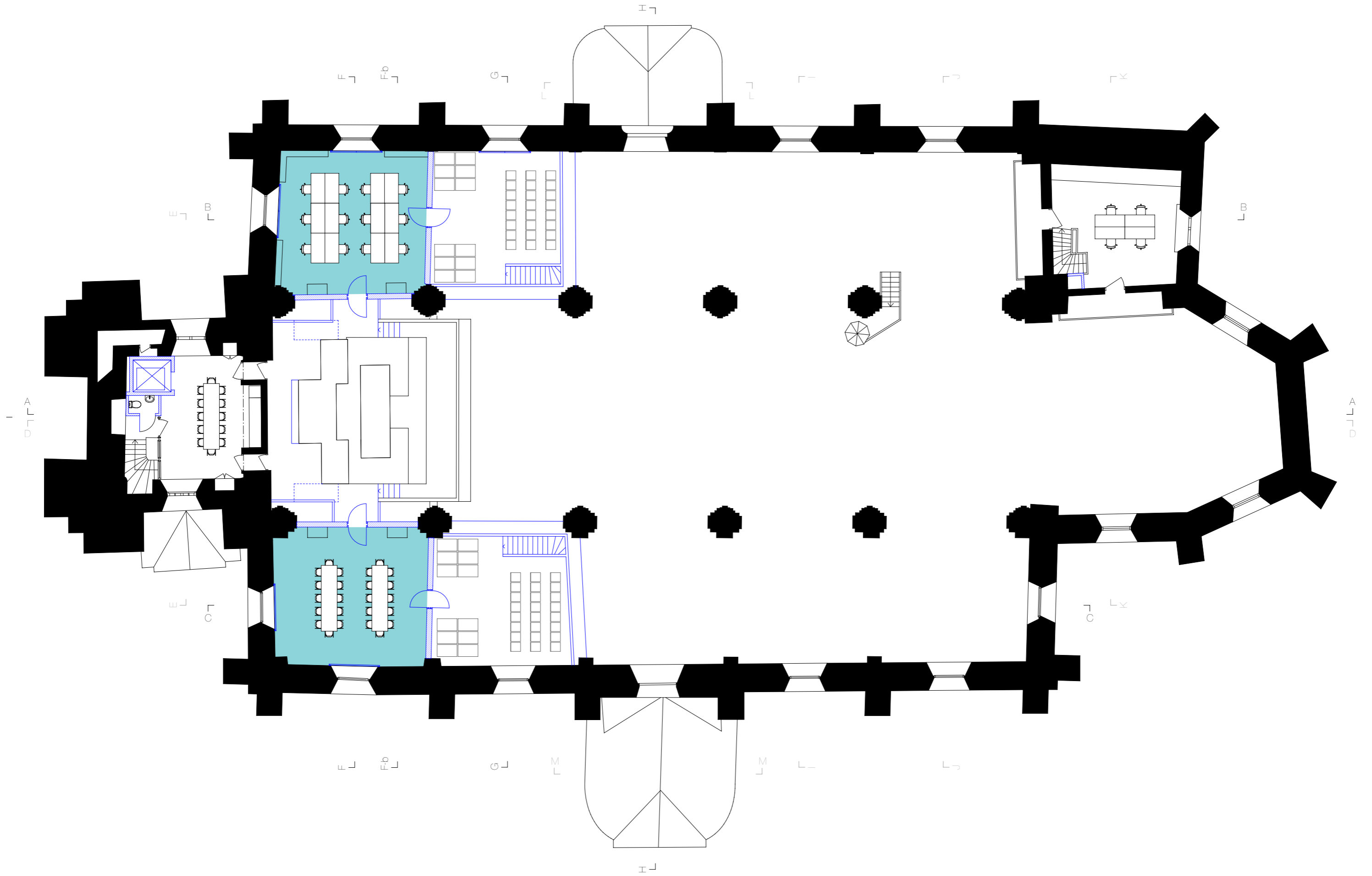

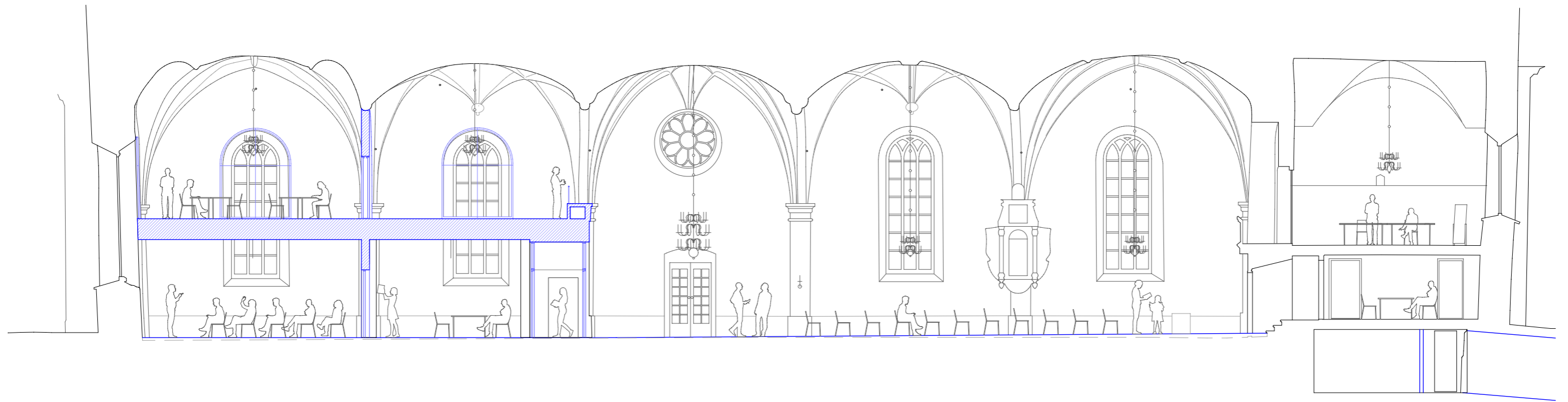

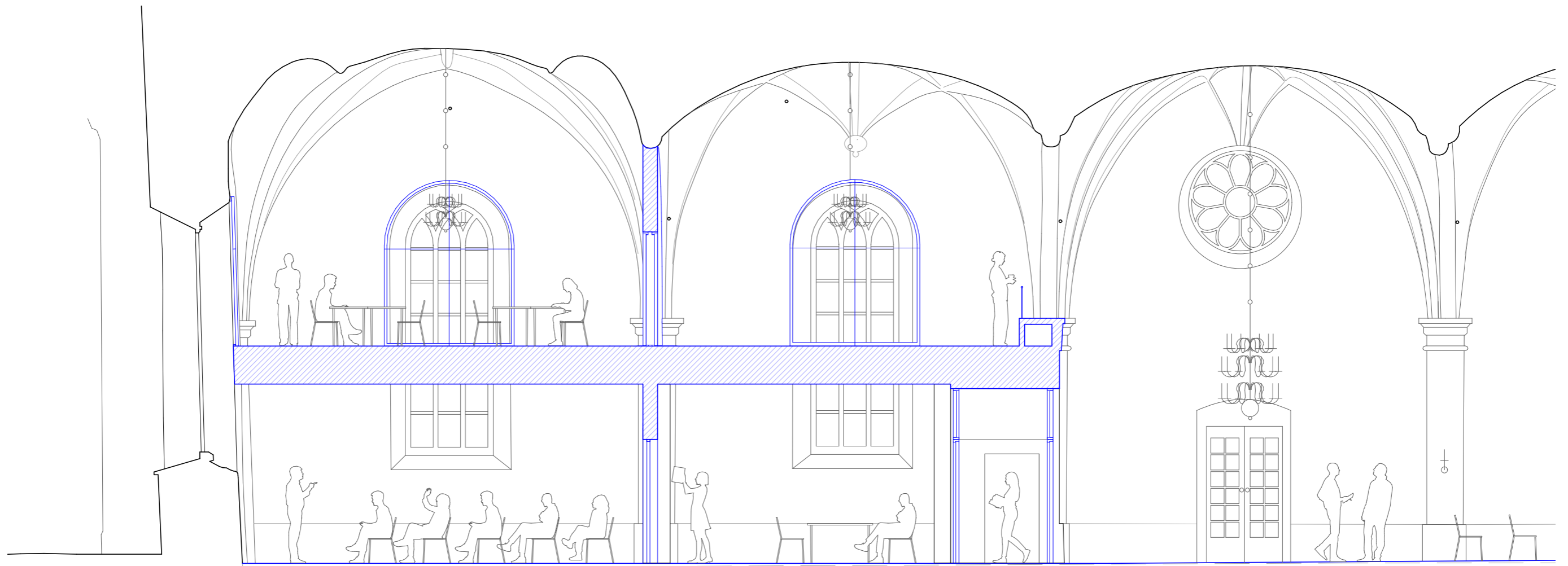

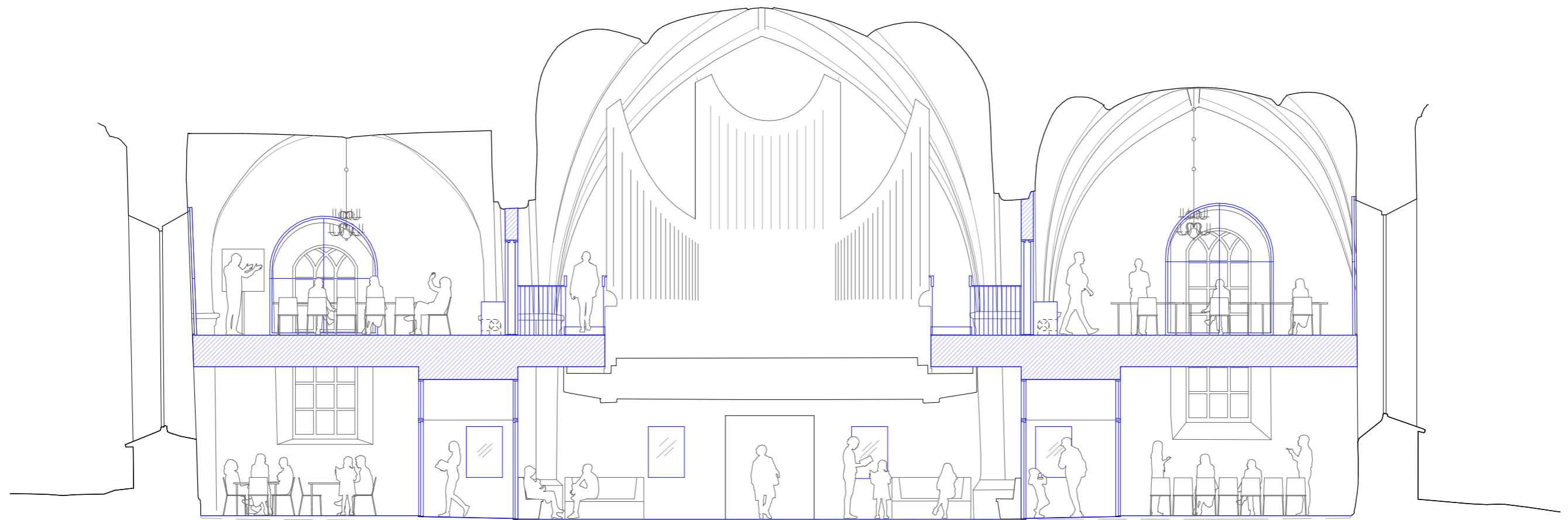

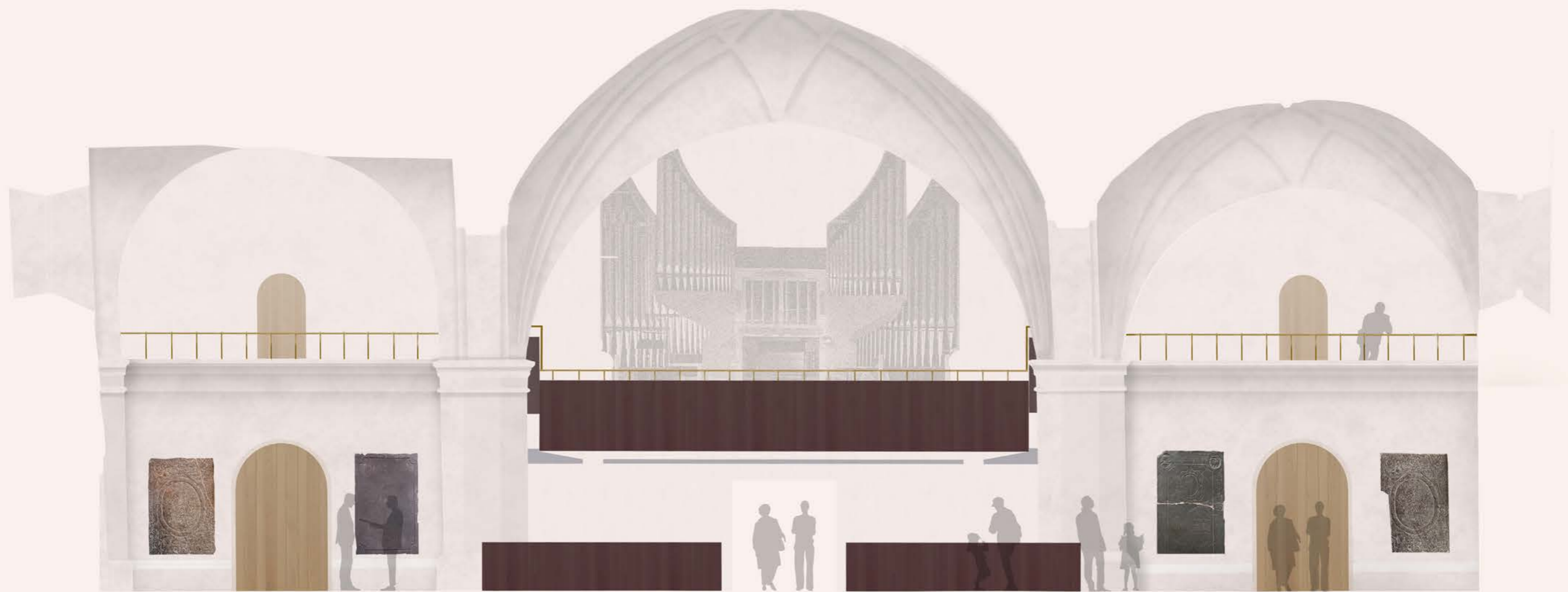

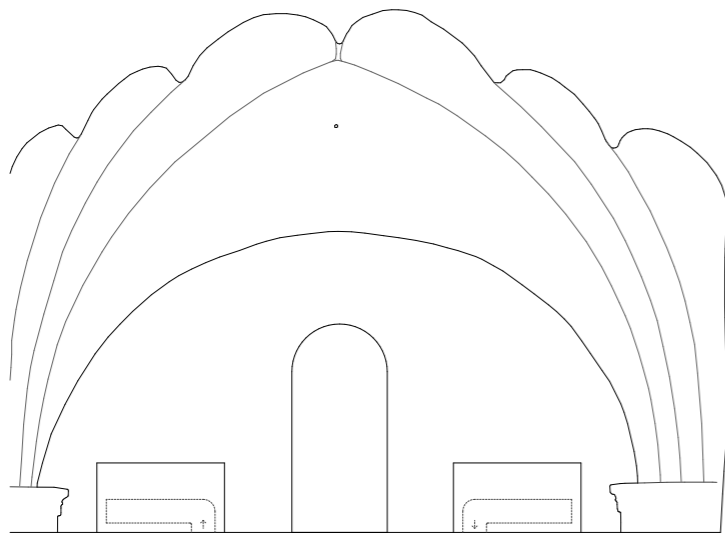

Elevationsdetalj ED201  
Vägg V201, läktarplan  
Skala 1:20

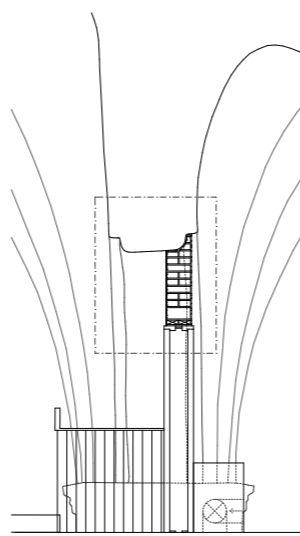

Sektionsdetalj SD201  
Vägg V201, läktarplan  
Skala 1:20

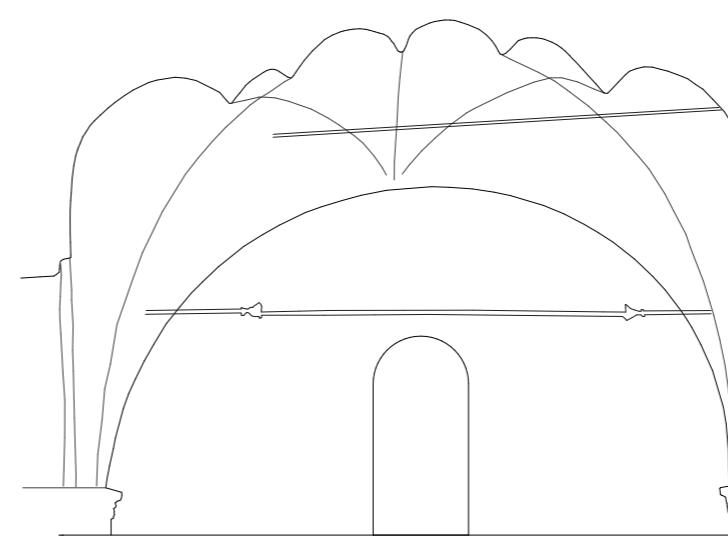

Elevationsdetalj ED202  
Vägg V202, läktarplan  
Skala 1:20

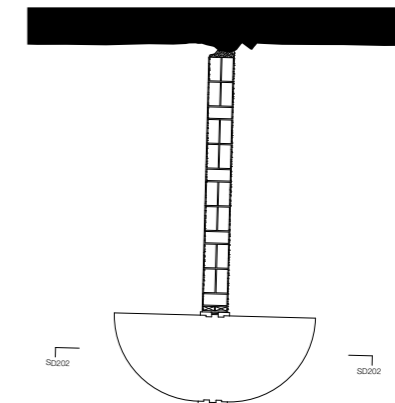

Planfigur för vägg V202, läktarplan  
Skala 1:20

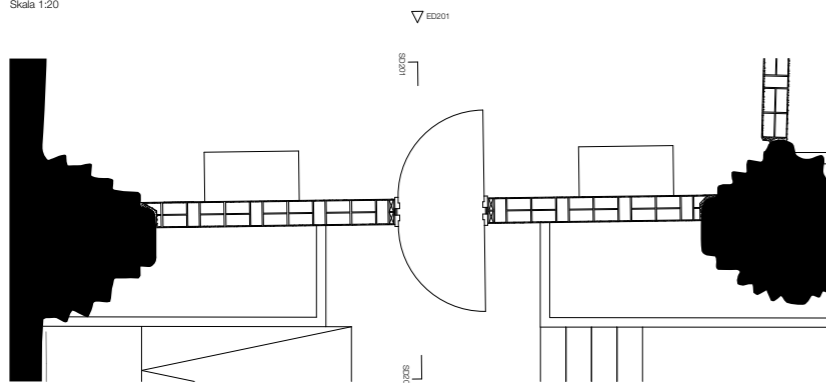

Planfigur för vägg V201, läktarplan  
Skala 1:20

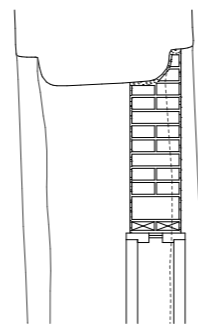

Detalj ur SD201 ovan  
Skala 1:10

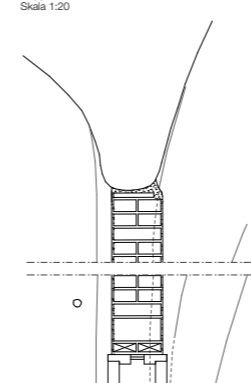

Detalj ur SD201  
Skala 1:10

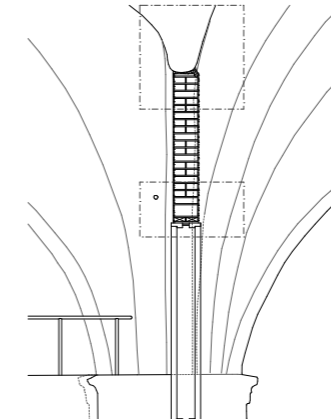

Sektionsdetalj SD202  
Vägg V201, läktarplan  
Skala 1:20

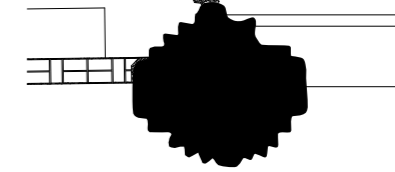

Planfigur för vägg V202, läktarplan  
Skala 1:20

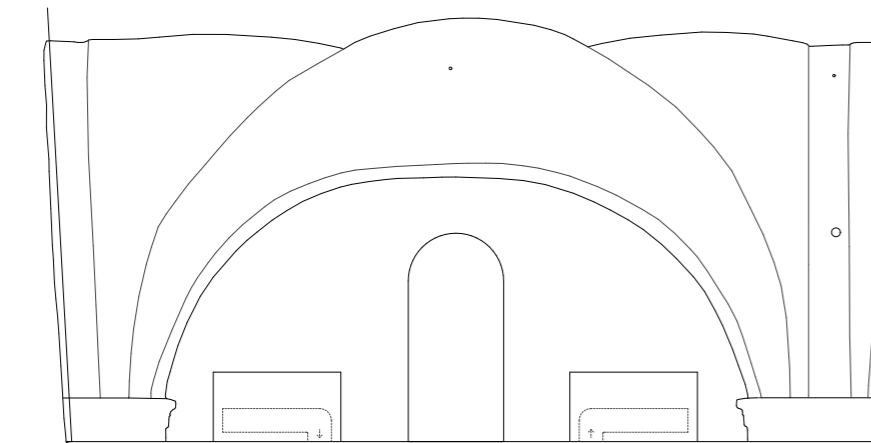

Elevationsdetalj ED203  
Vägg V201, läktarplan  
Skala 1:20

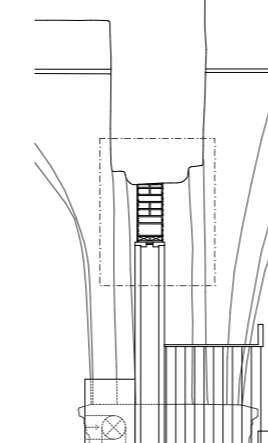

Sektionsdetalj SD203  
Vägg V201, läktarplan  
Skala 1:20

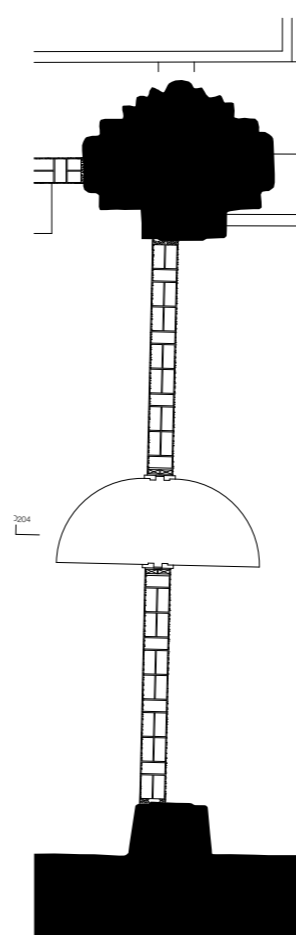

Planfigur för vägg V204, läktarplan  
Skala 1:20

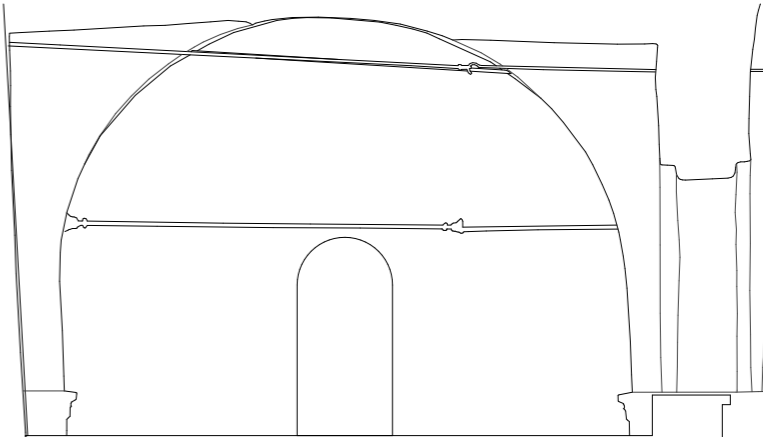

Elevationsdetalj ED204  
Vägg V204, läktarplan  
Skala 1:20

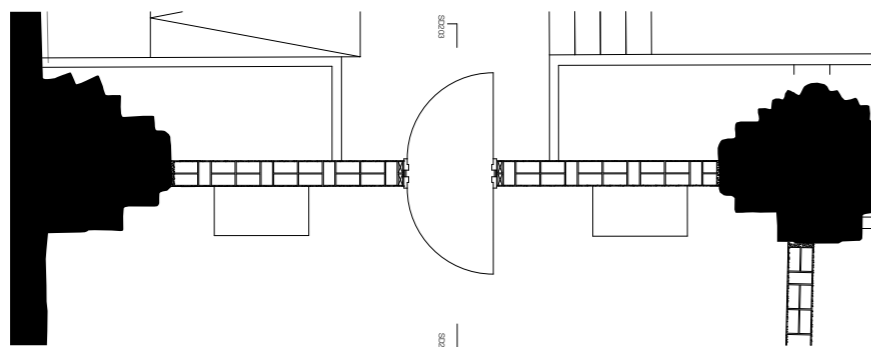

Planfigur för vägg V203, läktarplan  
Skala 1:20

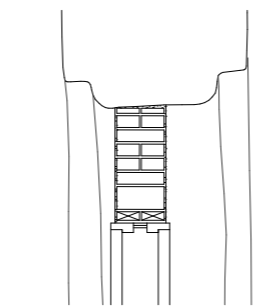

Detalj ur SD203  
Skala 1:10

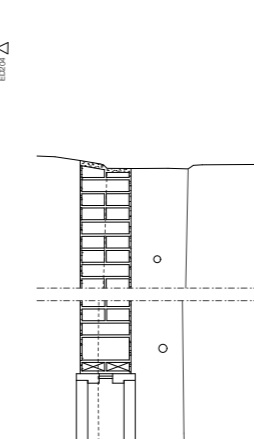

Detalj ur SD204 ovan  
Skala 1:10

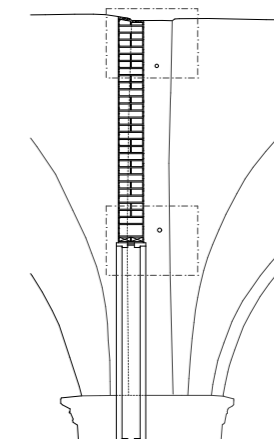

Sektionsdetalj SD204  
Vägg V201, läktarplan  
Skala 1:20















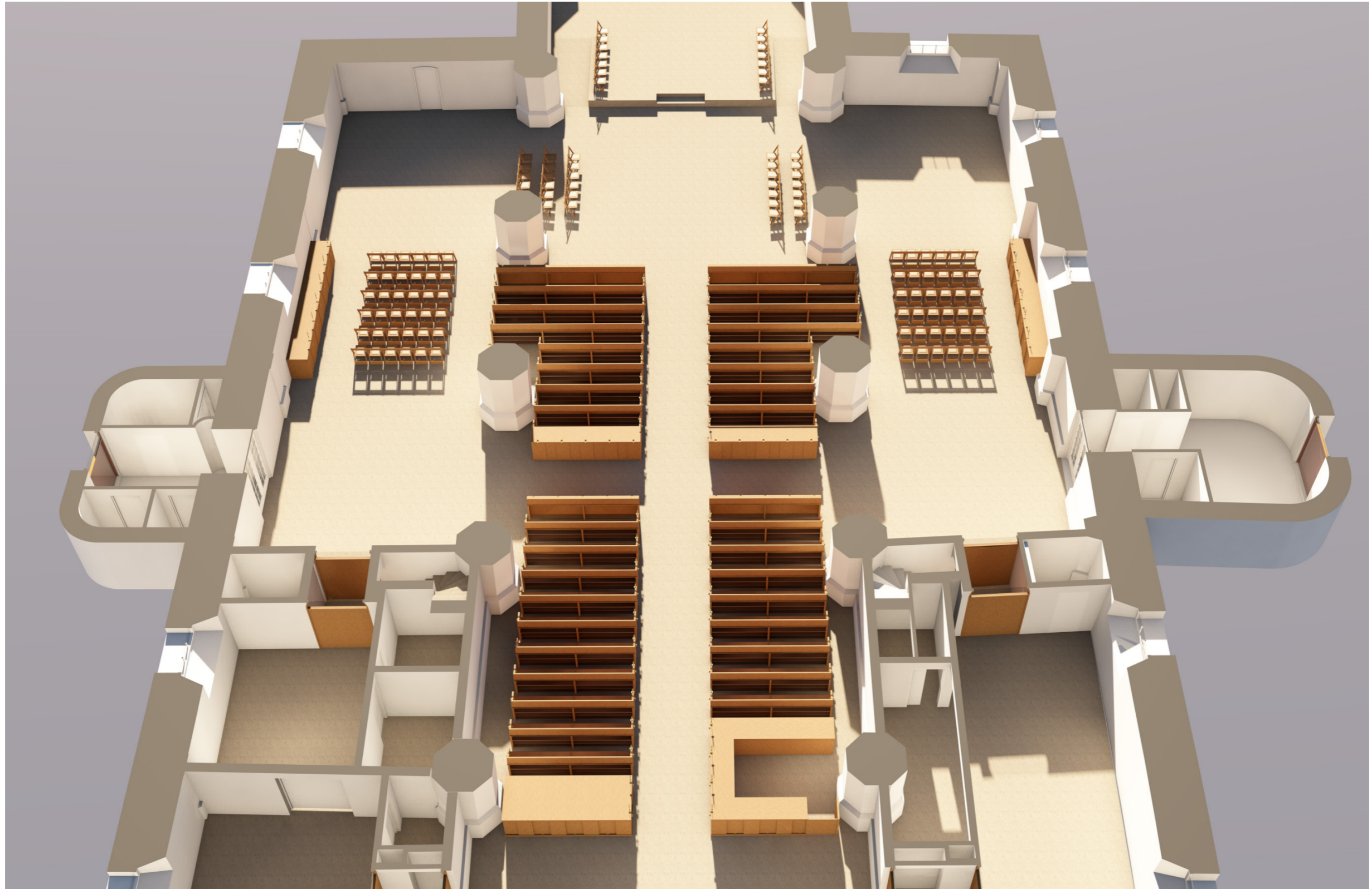

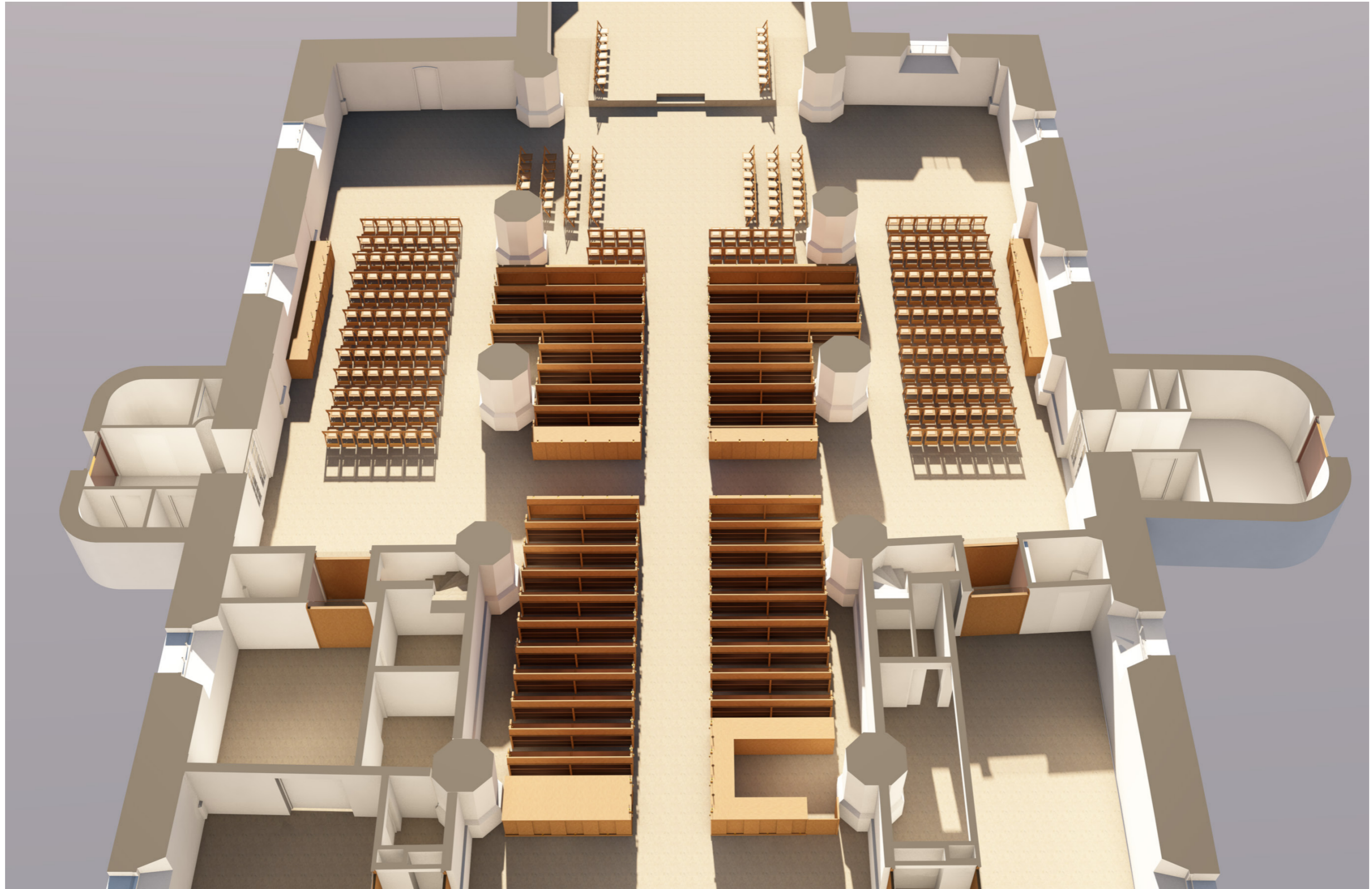

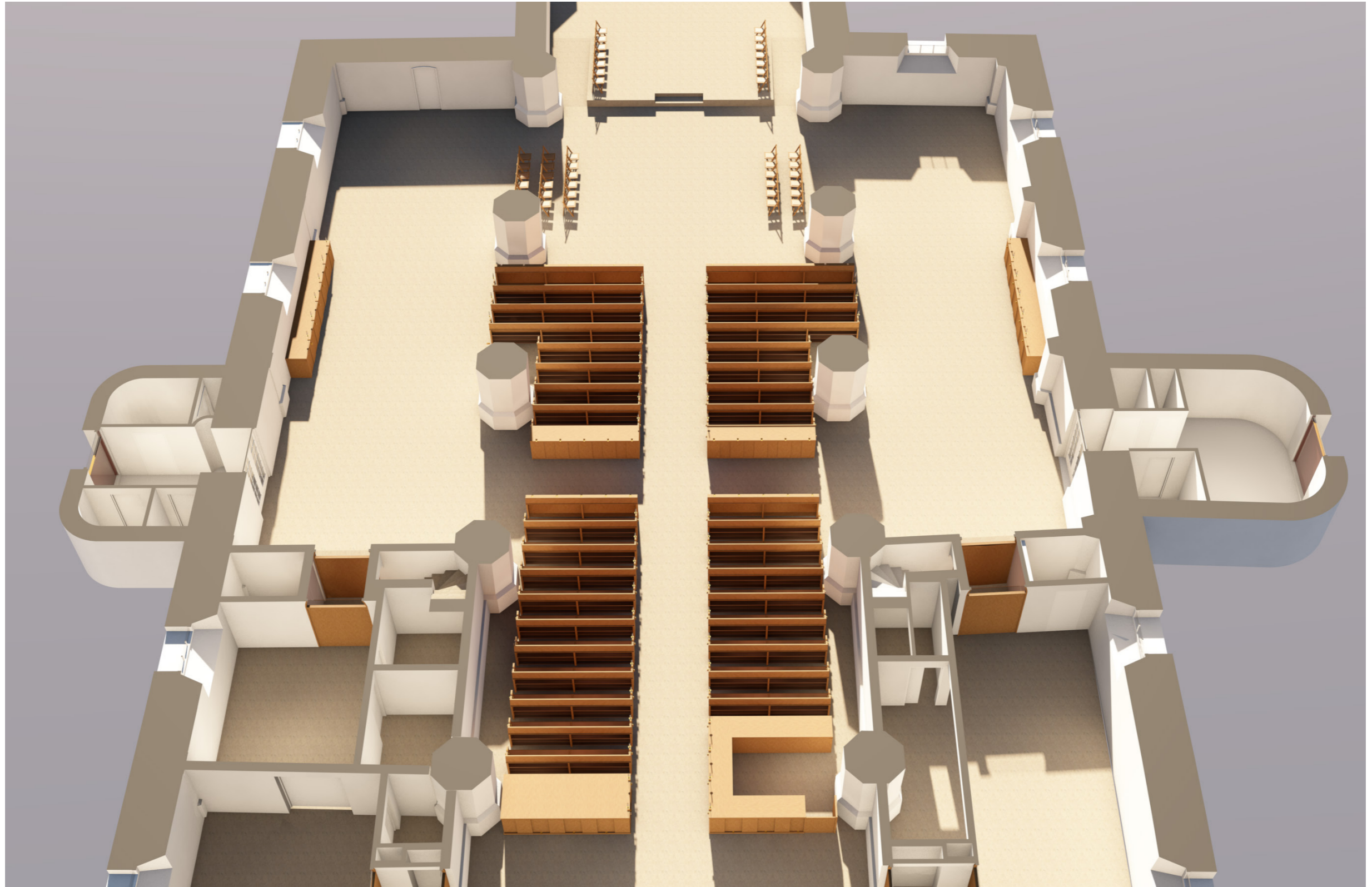

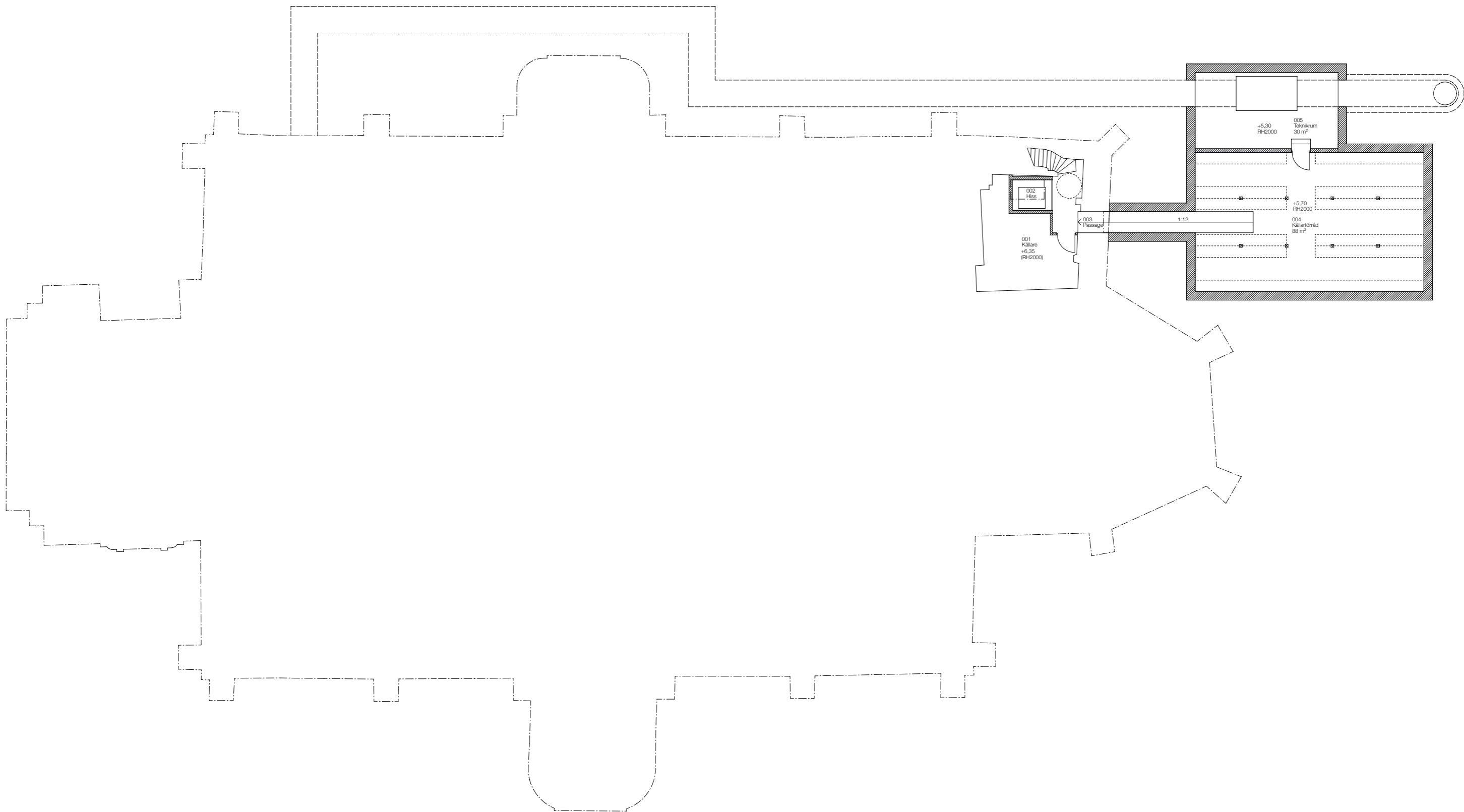



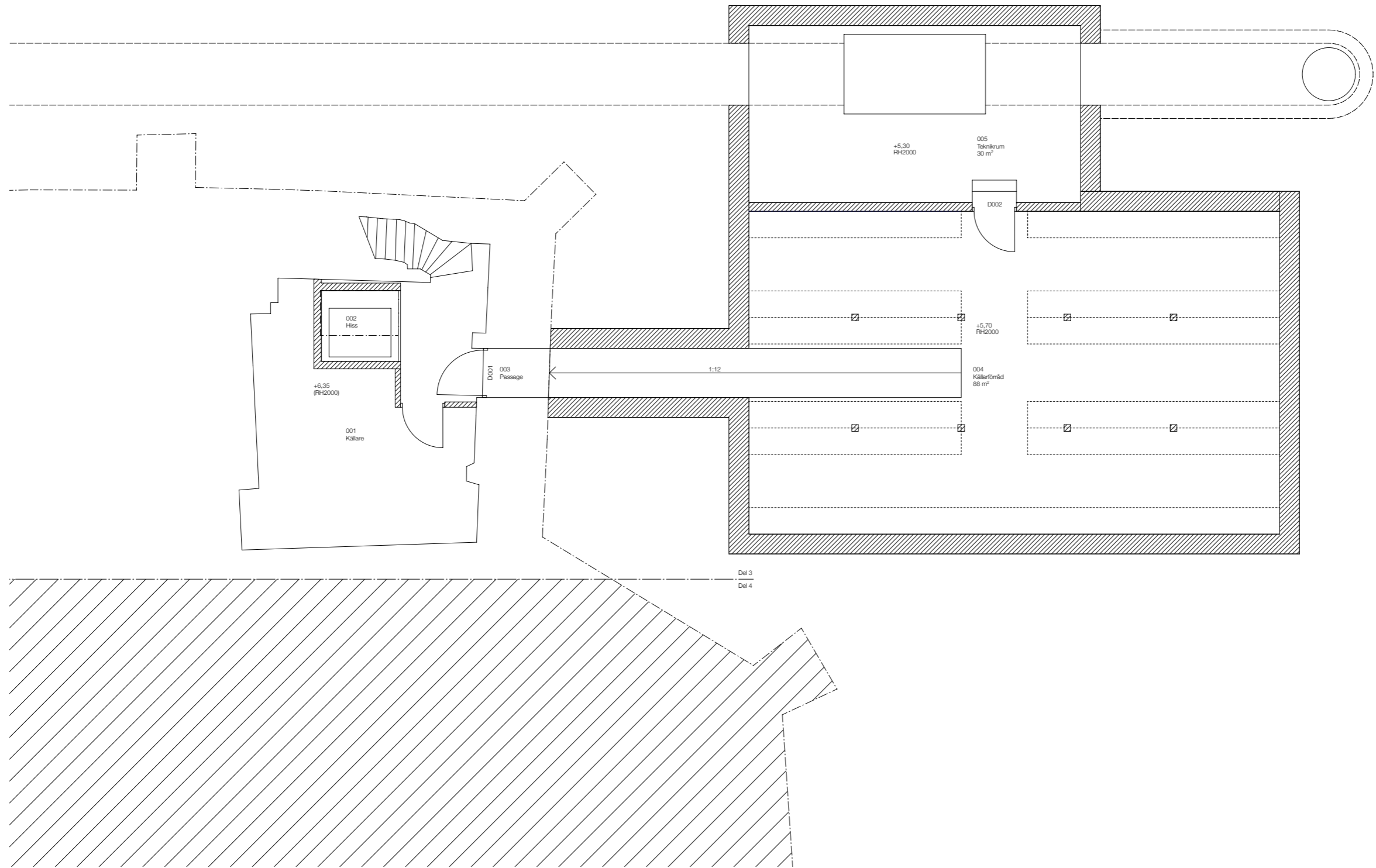

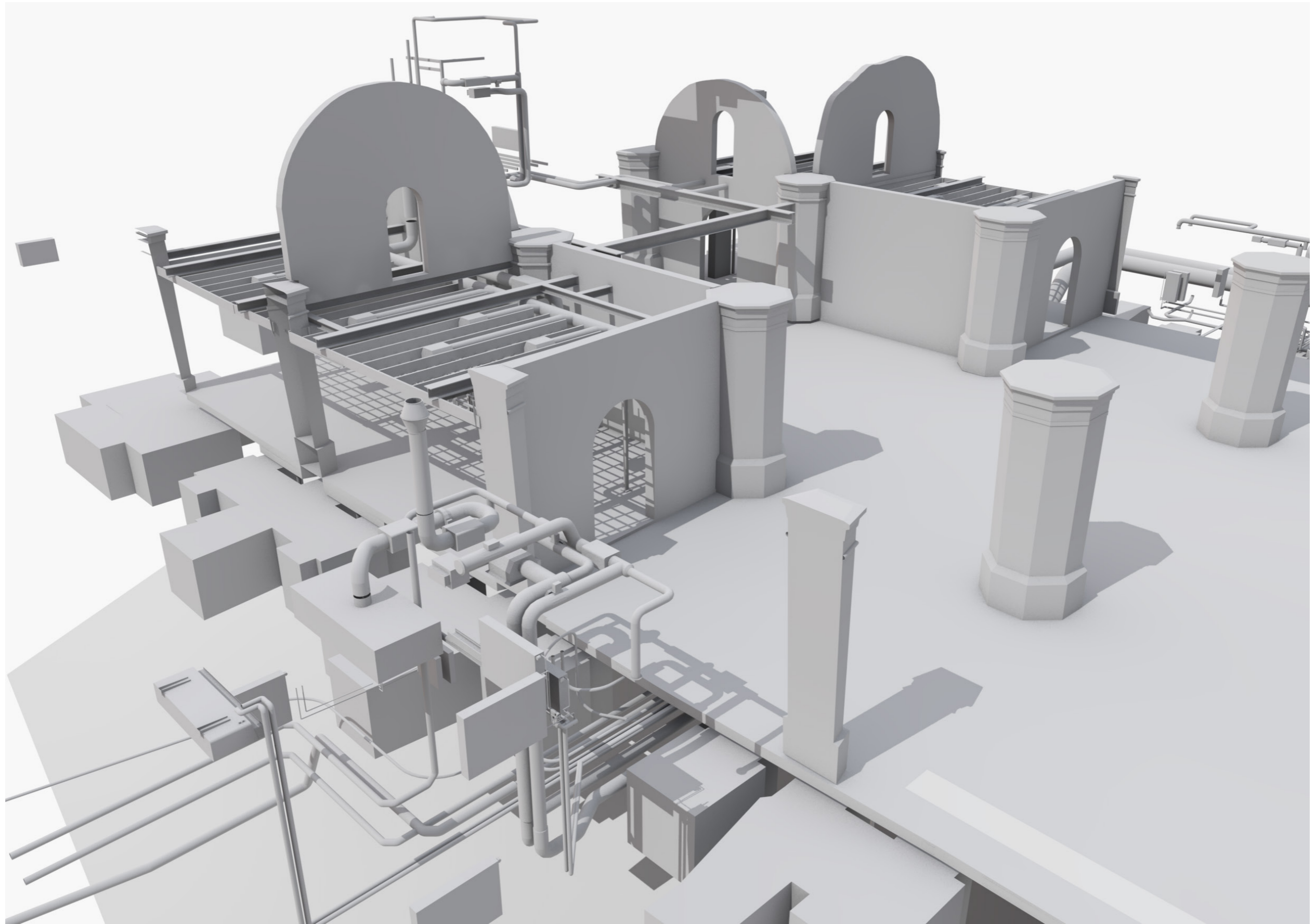

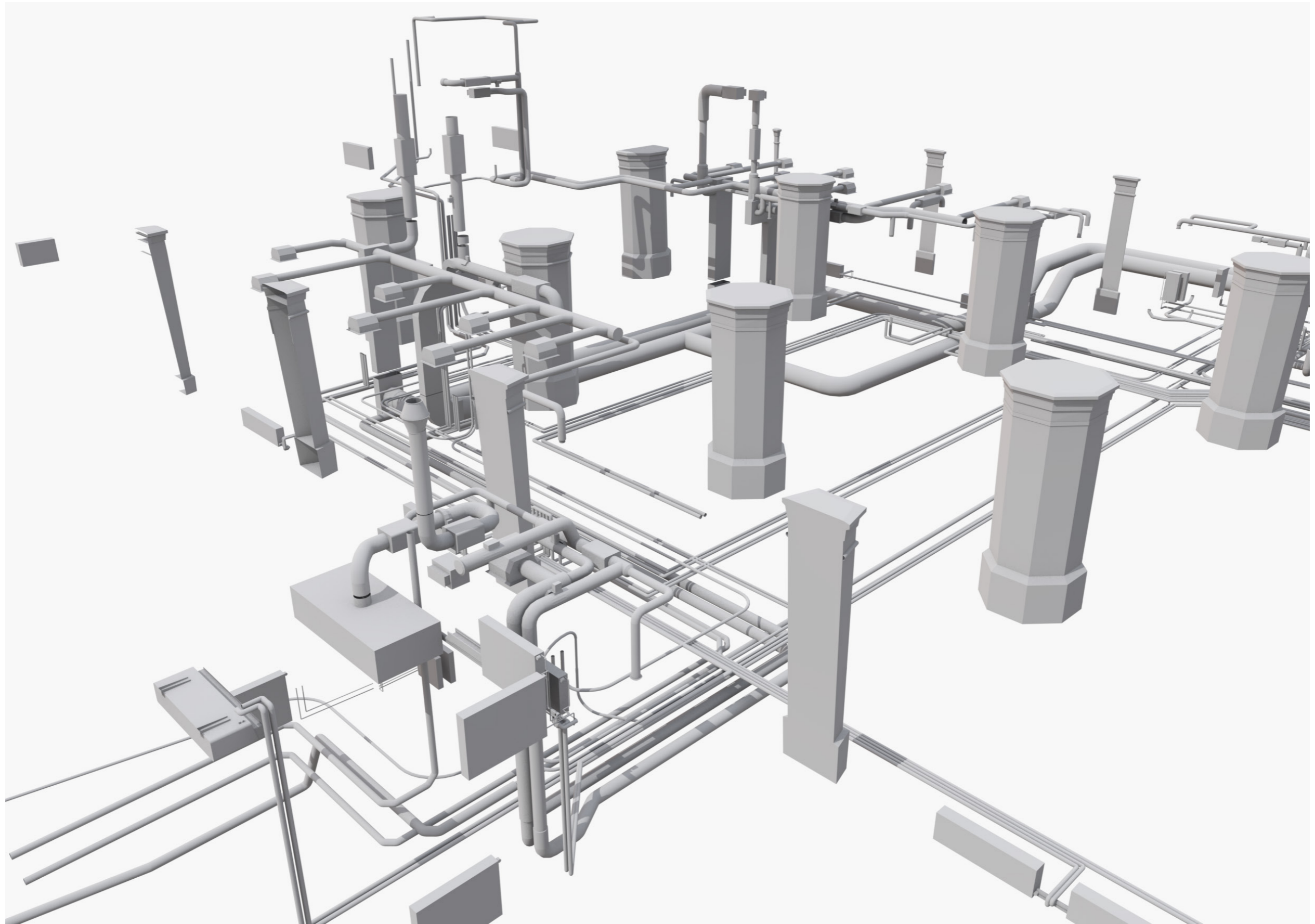



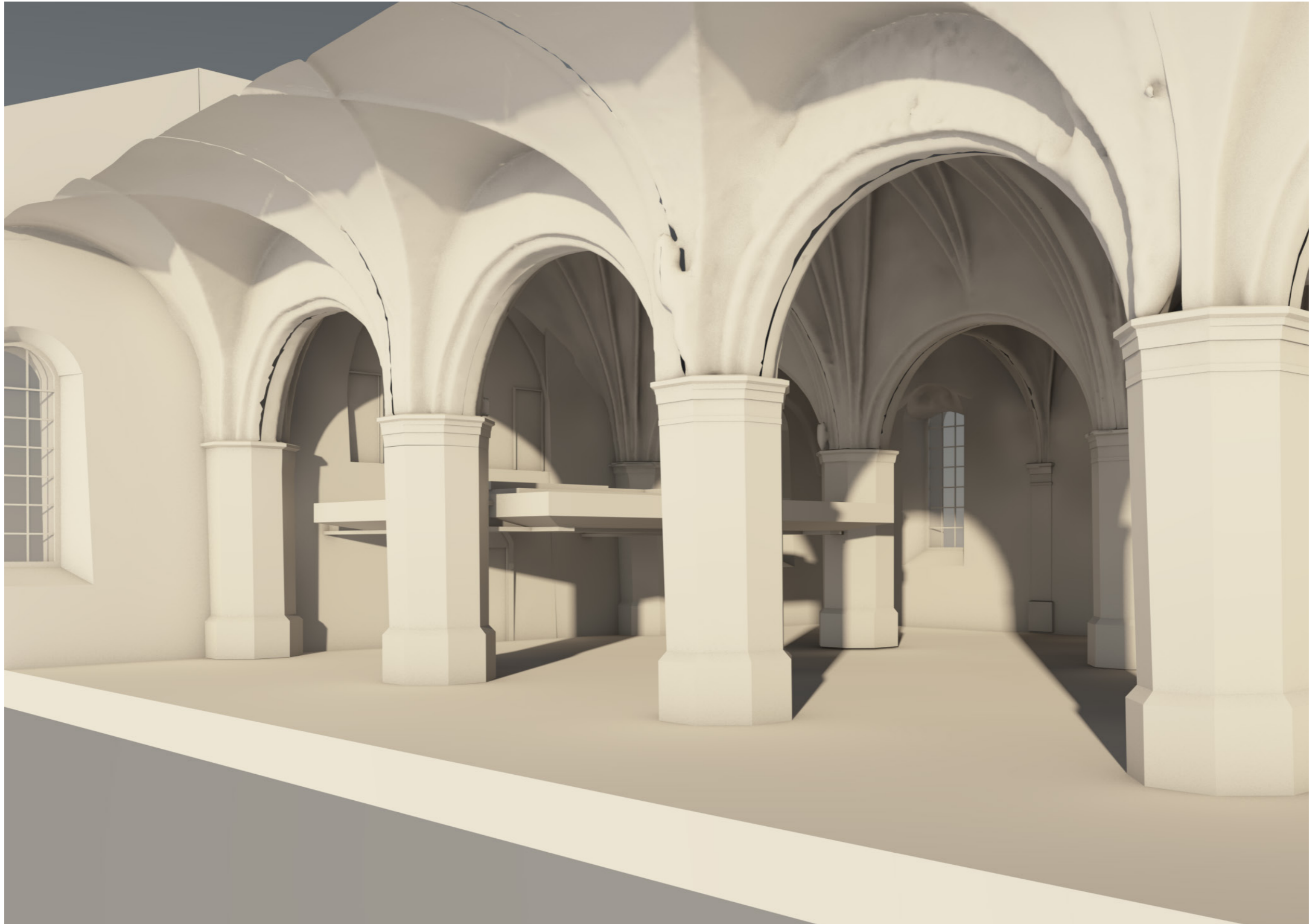

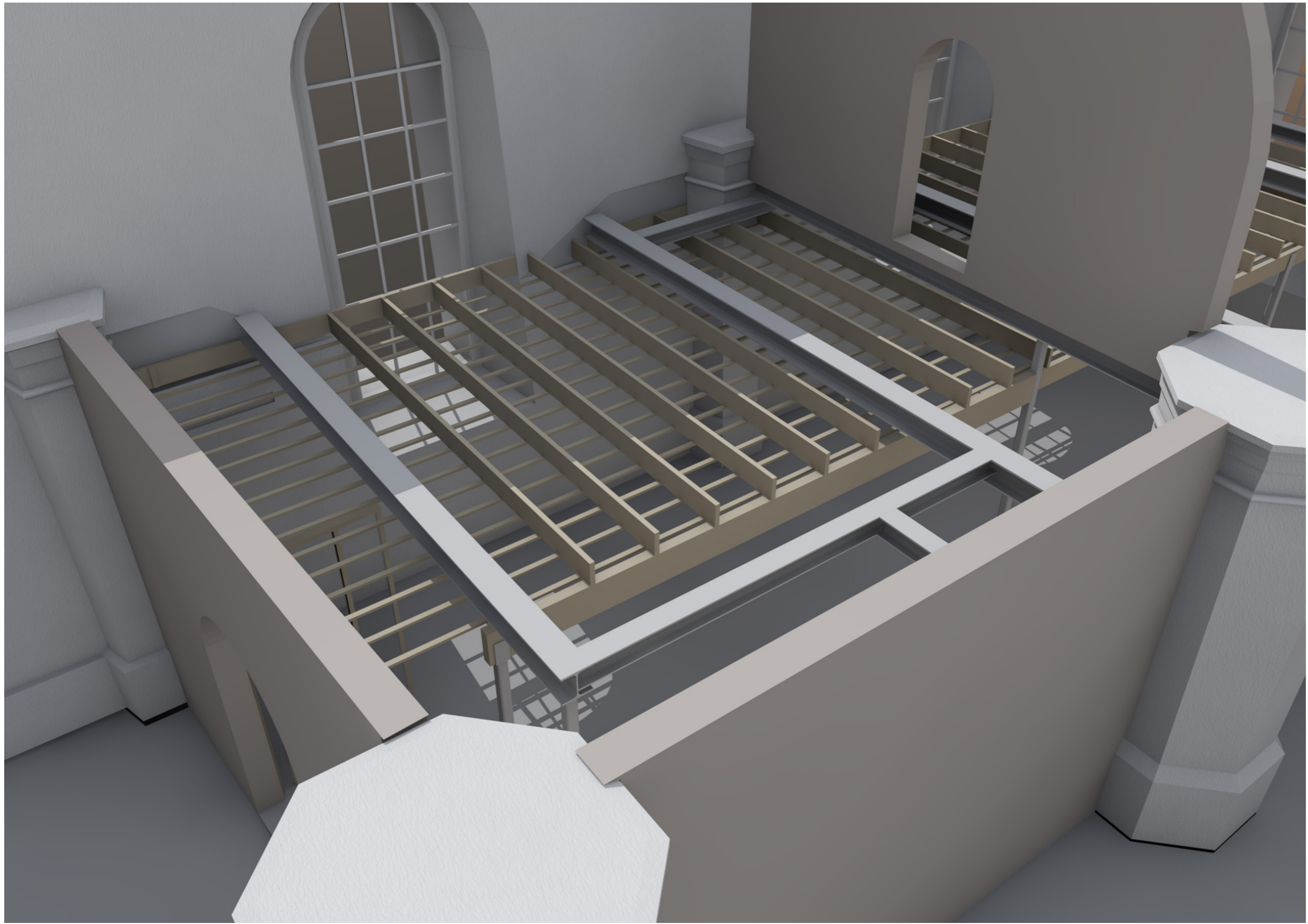

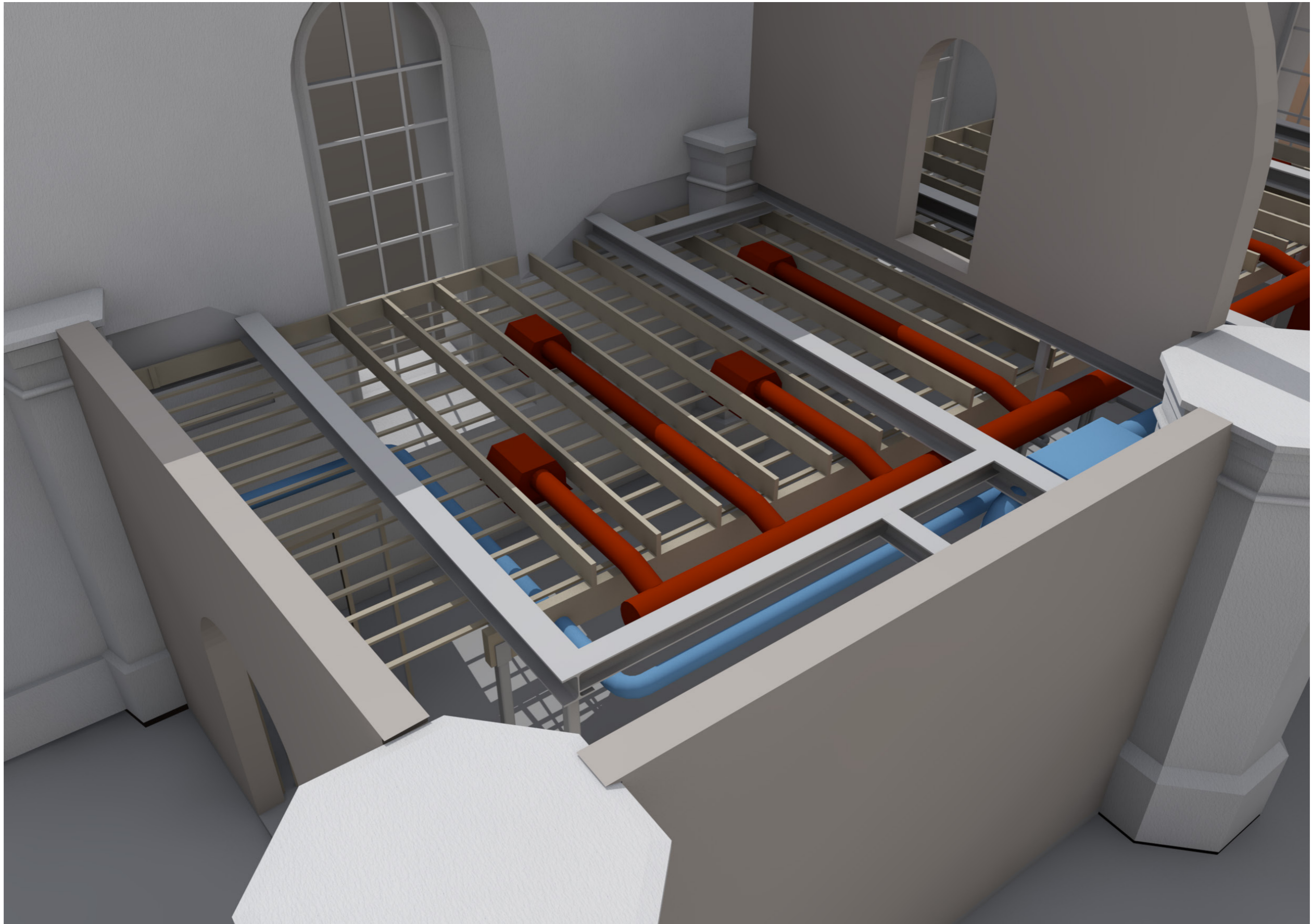













## SAMMANFATTNING

- Ljudavskiljda miljöer
- Flöden
- Flexibilitet
- Lättåtkomlig förvaring
- Tekniska installationer
- Helhetsperspektiv
- 100-årsperspektiv
- Tillståndsprocessen



## SAMMANFATTNING

- Ljudavskiljda miljöer
- Flöden
- Flexibilitet
- Lättåtkomlig förvaring
- Tekniska installationer
- Helhetsperspektiv
- 100-årsperspektiv
- Tillståndsprocessen

TACK!