

User Manual

Battery Pack-MOON10-W



CHISAGE ESS

www.chisage.com

Change History

Version 1.2 (2024.04.22):

Update **1.4 Nameplate**

Update **2.1 Battery Specification**

Update **4.1.4 Open the Package and Inspection**

Update **4.2.3 Connection Diagram**

Version 1.1 (2024.2.25):

Update **1.4 Nameplate**

Update **3.3 Interface Definition**

Update **3.7 Dip Switch**

Update **4.1.4 Open the Package and Inspection**

Version 1.0 (2023.10.07):

First released.

Content

Change History	1
Cautions	1
Declaration	1
Abbreviation	2
Definition	2
1. General Introduction	4
1.1 Scope and Purpose	4
1.2 Brief Introduction.....	4
1.3 Product Properties	4
1.4 Nameplate.....	5
2. Technical Specification	6
2.1 Battery Specification.....	6
3. Product Overview.....	7
3.1 Mechanical Structure.....	7
3.2 Dimension	7
3.3 Interface Definition.....	8
3.4 State LED Indicate.....	9
3.5 Capacity LED Indicate	10
3.7 Dip Switch	11
4. Installation and Configuration	14
4.1 Preparations for installation	14
4.2 Installation.....	16
5. Transportation and Storage	20
5.1 Transportation	20
5.2 Storage	20
6. Operation and Maintenance	21
6.1 Accident Handling	21
6.2 Maintenance	22



Cautions

Customers must abide by the operating specifications, and any installation, maintenance, and use of this product must strictly abide by the relevant safety regulations:

- It is forbidden to store or use at high temperatures, and it must be kept from heat sources. These environments above the safe temperature range will significantly decrease this product's performance and life and even cause serious consequences such as burning and explosion.
- It is forbidden to store and use in an environment with high static electricity or electromagnetic radiation. Otherwise, the electronic components in this product will be damaged, which may cause safety hazards
- Do not get wet or even immerse in water. Otherwise, it may cause an internal short circuit, function loss, or abnormal chemical reaction of the product and cause fire, smoke, explosion, etc.
- Suppose you find smoke, heat, discoloration or deformation, or any abnormal phenomenon during use, storage, transportation, and service. In that case, you should immediately contact the professional department to observe further and control the risk.
- Do not dispose of discarded products in fires or hot stoves. Waste batteries should be recovered and recycled by professional institutions or organizations.
- Professional technicians must operate the installation and maintenance of the battery system, and the user must strictly abide by the relevant safety regulations. It is strictly forbidden for non-professionals to install or repair the battery system and abuse it beyond the range.

Declaration

Before you use this product, make sure you have read and fully accept the following information:

- Zhejiang Chisage New Energy Technology Co., Ltd. will not be liable for the loss of personnel and property caused by the violation of the product specifications, conditions of use, scope of work, precautions and other provisions in this document.
- There are potential risks and hazards in the process of installation, storage, transportation, use, maintenance and repair of this product. Please perform operations according to the corresponding requirements.
- In the use, service and maintenance of products, users should establish correct rules, Zhejiang Chisage New Energy Technology Co., Ltd. will give necessary technical support.
- Zhejiang Chisage New Energy Technology Co., Ltd. reserves the right of final interpretation of all problems of this product. If you have any question or objection to the product, please contact the professional department of Zhejiang Chisage New Energy

Technology Co., Ltd.

- During the storage process, the storage temperature and humidity do not exceed the above requirements and must be protected from rain.
- It is strictly prohibited to disassemble PACK without the permission of Zhejiang Chisage New Energy Technology Co., Ltd. is not responsible for the problems arising therefrom.

Abbreviation

BMS	Battery Management System
BOL	Begin of Life
CAN	Controller Area Network
EOL	End of Life
HV	High Voltage
LV	Low Voltage
OCV	Open Circuit Voltage
SOC	State of Charge

Definition

Battery Cell	The minimum energy storage unit, a basic electrochemical energy storage device, consists of a positive electrode, a negative electrode, an electrolyte, a separator, and a casing, also known as a battery cell.
Battery Module (Battery PACK)	A power supply system composed of several battery modules, circuit equipment (protection circuit, cell management system, electrical and communication interfaces), thermal management devices, etc., is used to provide energy for electrical devices.
Nominal Voltage	Indicates or identifies the appropriate voltage approximation for the cell or pack.
Capacity	The amount of electricity that can be provided by a battery cell that is fully charged under specified conditions. Usually expressed in Ah.
Energy Capacity	The energy can be provided by a fully charged battery cell or pack under specified conditions. Usually expressed in Wh or kWh.
Nominal Capacity	At the beginning of life (BOL), the minimum capacity that a fully charged cell can be provided under specified conditions is when it is discharged at a rate of 1C (C-rate).

Unit	"V" (Volt): Electrical current unit; "A" (Ampere): Electrical current unit; "Ah" (Ampere-Hour): Electrical charge unit; "Wh" (Watt-Hour): Electrical energy unit; "Ω" (Ohm): Resistance unit; "°C" (Celsius degree): Temperature unit; "mm"(millimeter): Length unit; "s" (second): Time unit; "kg" (kilogram): Weight unit; "Hz" (Hertz): Frequency unit.
------	---

1. General Introduction

1.1 Scope and Purpose

This product user manual only applies to the rechargeable lithium-ion battery products MOON10-W designed by Zhejiang Chisage New Energy Technology Co., Ltd.

The user manual aims to introduce the MOON10-W product information and installation, operation, and maintenance guidelines. Include the battery pack and BMS specification, internal and external structure, LED indication, battery set, battery system diagram, and other cautions. The manual cannot include complete information about the BESS system.

The interpretation right of this specification belongs to Zhejiang Chisage New Energy Technology Co., Ltd.

1.2 Brief Introduction

MOON10-W is designed according to market requirements to meet the client's wall mounted application requirement. In operation with the hybrid or off-grid inverter, you can charge the battery when PV or grid is available and discharge the battery when you need the backup power supply.

The battery can be paralleled to build a high-capacity hybrid system to satisfy the long-time energy storage demand.

1.3 Product Properties

MOON10-W product's anode materials are lithium iron phosphate, and battery cells are managed effectively by BMS with better performance, the systems features as below:

- Anode materials are lithium iron phosphate (LiFePO₄), safer with a longer life span.
- Flexible configurations allow parallel multi-battery for longer standby time.
- Self-ventilation with lower system noise.
- With a wide range of temperatures for the working environment, 0°C~+50°C, circulation span, and discharging performance are well under high temperatures.
- Carries battery management system with better performance and possesses protection functions like over-discharge, over-charge, over-current, and abnormal temperature.
- Self-management on charging and discharging, single core balancing function.
- Support the most mainstream CAN and RS485 protocol

1.4 Nameplate



Model: MOON10-W		
Description:	Battery Pack	
Total Energy:	10.24kWh	
Nominal Capacity:	200Ah	
Voltage Range:	40~58.4Vdc	
Nominal Voltage:	51.2Vdc	
Max. Charge Voltage:	58.4±0.5Vdc	
Constant Current:	150A	
Operation Temperature:	-20°C~55°C	
Ingress Protection:	IP21	
Weight:	92.5±5kg	
Dimension:	W600xH822xD187.5mm	
Company: Zhejiang Chisage New Energy Technology Co., Ltd.		
Address: No.1828 Fuqing South RD., Panhuo ST., Yinzhou, Ningbo, Zhejiang, 315100 China.		
Tel: +86 150 5749 1826		Email: info@chisagess.com
Website: www.chisagess.com		
SN: 		
Made in China		

Fig. 1-1 MOON10-W nameplate

2. Technical Specification

2.1 Battery Specification

No.	Item	Specification	Remark
1	Battery Cell Model	LFP200Ah	Lithium Iron Phosphate
2	Battery Module Model	2P16S-100Ah	
3	Nominal Capacity	200Ah	
4	Nominal Voltage	51.2V	Singe cell: 3.2V
5	Operation Voltage Range	40V~58.4V	
6	Nominal Energy	10.24kWh	
7	Operation Voltage	Charge Temperature: 0°C~55°C; Discharge Temperature: -20°C~55°C.	
8	Storage Temperature	-20°C~50°C	25°C is necessary for more than three-month of storage
9	Working Humidity	20~85%RH	
10	Standard Charge Current	100A	
11	Maximum Continuous Charge Current	150A	
12	Standard Discharge Current	100A	
13	Maximum Continuous Discharge Current	150A	
14	PACK Weight	About 92.5Kg	
15	Dimension	Width: 600 (±2) mm Height: 822 (±2) mm Depth: 187.5 (±2) mm	

3. Product Overview

3.1 Mechanical Structure

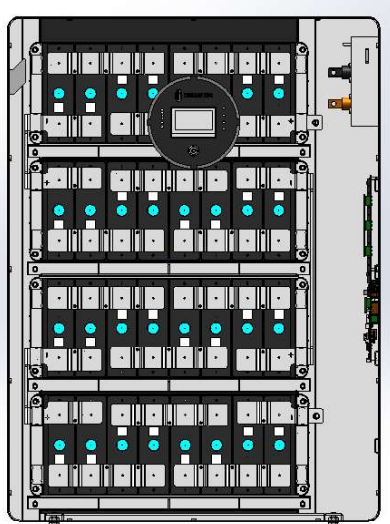

Fig. 3-1 MOON10-W PACK mechanical structure 1

3.2 Dimension

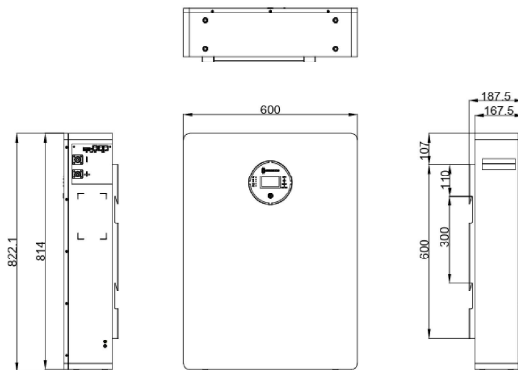

Fig. 3-2 MOON10-W PACK dimension drawing

3.3 Interface Definition

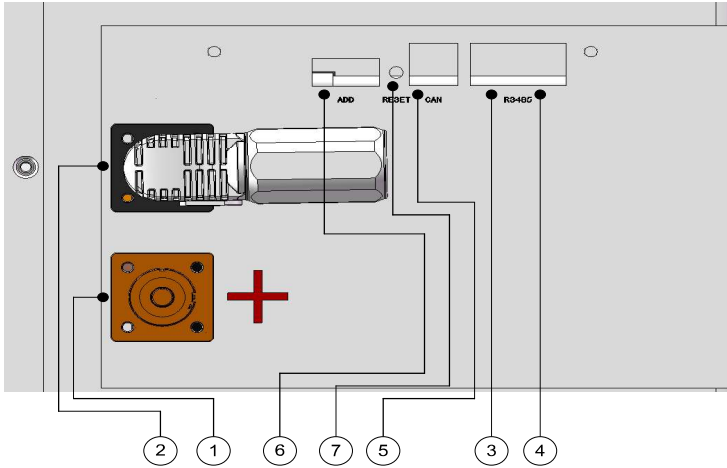

Fig. 3-3 MOON10-W PACK interface

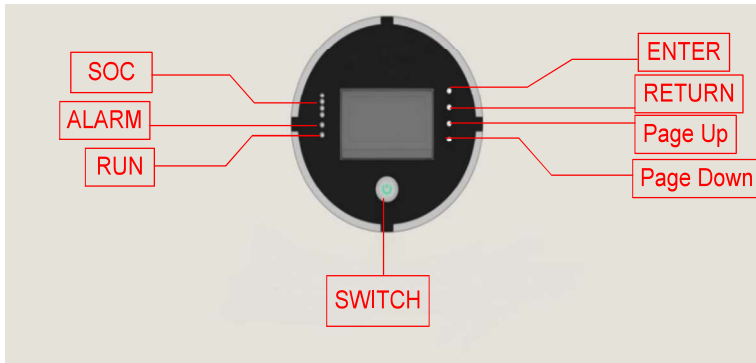

Fig. 3-4 MOON10-W PACK Interface

No.	Interface	Connector	Description	Remark
1	Battery power +	150A	Positive Pole	
2	Battery power -	150A	Negative Pole	

3	Host computer /Parallel port	RJ45	RS485-A PIN 1, 8: 485-B PIN 2, 7: 485-A PIN 3, 6: GND PIN4 ,5: NC	The network cable adopts Category 5 double-shielded twisted pair cable, shielded crystal head RJ45 (8P8C), and the actual product shall prevail.
4	Parallel port	RJ45	RS485-B PIN 1, 8: 485-B PIN 2, 7: 485-A PIN 3, 6: GND PIN4 ,5: NC	The network cable adopts Category 5 double-shielded twisted pair cable, shielded crystal head RJ45 (8P8C), and the actual product shall prevail.
5	BMS communication port	RJ45	CAN & RS485 PIN 1, 8: 485-B PIN 2, 7: 485-A PIN 4: CANH PIN4 ,5: CANL PIN 3, 6: GND	The network cable adopts Category 5 double-shielded twisted pair cable, shielded crystal head RJ45 (8P8C), and the actual product shall prevail.
6	Reset button	/	After the battery reaches the limit protection, it needs to be restarted by the Reset button.	
7	Dipswitch	/	Please check clause 3.8	Setting the battery address and BMS communication protocols.

Note: The RS485A Parallel port also can be used for host computer software monitoring and protection parameter setting.

3.4 State LED Indicate

BMS has 1 run light, 1 warning light, 4 capacity indicators

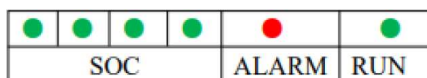

System State	Running State	RUN	ALM	Capacity LED				Remark
		●	●	●	●	●	●	

Battery Off	Sleep	OFF	OFF	All OFF	
Battery Standby	Normal	Flash 1	OFF	Check Capacity LED	
Charge	Normal	ON	OFF	Check Capacity LED	Maximum LED flash2
	Alarm	ON	Flash 2	Check Capacity LED	Maximum LED flash 2
	Voltage Protection	Flash 1	OFF	All OFF	
	Temperature, overcurrent, short circuit, fail protection	Flash 1	Flash 1	All OFF	
Discharge	Normal	Flash 3	OFF	Check Capacity LED	
	Alarm	Flash 3	Flash 3	Check Capacity LED	
	Voltage Protection	Flash 2	OFF	All OFF	
	Temperature, overcurrent, short circuit, fail protection	OFF	ON	All OFF	
	undervoltage protection	All OFF			

3.5 Capacity LED Indicate

State	Charge				Discharge			
	L4●	L3●	L2●	L1●	L4●	L3●	L2●	L1●
0~25%	OFF	OFF	OFF	Flash	OFF	OFF	OFF	ON
25%~50%	OFF	OFF	Flash	ON	OFF	OFF	ON	ON
50%~75%	OFF	Flash	ON	ON	OFF	ON	ON	ON

75%~100%	Flash	ON	ON	ON	ON	ON	ON	ON
Operation LED ●	ON				Flash			

3.6 LED Flash Mode

Mode	ON	OFF
Flash 1	0.25S	3.75S
Flash 2	0.5S	0.5S
Flash 3	0.5S	1.5S

3.7 Dip Switch

Bit1 to bit4 are used to set the address, bit5 to bit8 are used for the number of slaves battery.

Master battery setting:

Bit1 to bit4 are 0, the address of master is fixed to 0. bit5 to bit8 are set according to the number of slaves connected in parallel.





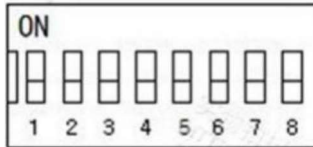





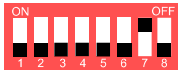

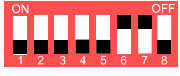
Slave battery setting:

Bit1 to bit4 are set according to the device order, the slave address range is 1 to 15. bit5 to bit8 are fixed to 0.

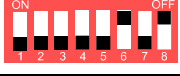











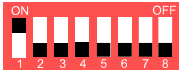
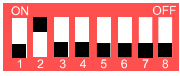
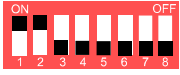

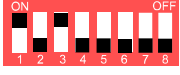
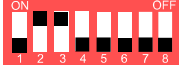
Master battery setting table:

Parallel Quantity	Dip Switch Setting					Remark
	K1-K4	K5	K6	K7	K8	
0 (Single battery operation)	OFF	OFF	OFF	OFF	OFF	
1	OFF	ON	OFF	OFF	OFF	
2	OFF	OFF	ON	OFF	OFF	

3	OFF	ON	ON	OFF	OFF	
4	OFF	OFF	OFF	ON	OFF	
5	OFF	ON	OFF	ON	OFF	
6	OFF	OFF	ON	ON	OFF	
7	OFF	ON	ON	ON	OFF	
8	OFF	OFF	OFF	OFF	ON	
9	OFF	ON	OFF	OFF	ON	
10	OFF	OFF	ON	OFF	ON	
11	OFF	ON	ON	OFF	ON	
12	OFF	OFF	OFF	ON	ON	
13	OFF	ON	OFF	ON	ON	
14	OFF	OFF	ON	ON	ON	
15	OFF	ON	ON	ON	ON	

Slave Battery Settings:

Address	Dip Switch Setting				
	K1	K2	K3	K4	K5-K8

1	ON	OFF	OFF	OFF	OFF	
2	OFF	ON	OFF	OFF	OFF	
3	ON	ON	OFF	OFF	OFF	
4	OFF	OFF	ON	OFF	OFF	
5	ON	OFF	ON	OFF	OFF	
6	OFF	ON	ON	OFF	OFF	
7	ON	ON	ON	OFF	OFF	
8	OFF	OFF	OFF	ON	OFF	
9	ON	OFF	OFF	ON	OFF	
10	OFF	ON	OFF	ON	OFF	
11	ON	ON	OFF	ON	OFF	
12	OFF	OFF	ON	ON	OFF	
13	ON	OFF	ON	ON	OFF	
14	OFF	ON	ON	ON	OFF	
15	ON	ON	ON	ON	OFF	

4. Installation and Configuration

4.1 Preparations for installation

This system can only install by personnel who have been trained in the power supply system and have sufficient knowledge of the power system.

The local safety regulations listed below should always be followed during the installation.

- All circuits connected to this power system with an external voltage of less than 48V must meet the SELV requirements defined in the IEC60950 standard.
- If operating within the power system cabinet, make sure the power system is not charged. Battery devices should also be switched off.
- Distribution cable wiring should be reasonable and has protective measures to avoid touching these cables during the operation of power equipment.
- When installing the battery system, must wear the protective items below:



The isolation gloves



Safety goggles



Safety shoes

4.1.1 Environmental requirements

- Working temperature: $-20^{\circ}\text{C} \sim +55^{\circ}\text{C}$
 - 1) Charging temperature range is $0^{\circ}\text{C} \sim +50^{\circ}\text{C}$;
 - 2) Discharging temperature range is $-20^{\circ}\text{C} \sim +55^{\circ}\text{C}$;
- Relative humidity: 20% ~ 80%RH (No condensed water);
- Operating environment: Indoor installation, sites avoid the sun and no wind, no conductive dust and corrosive gas. And the following conditions are met:
 - 1) Installation location should be away from the sea to avoid brine and high humidity environment;
 - 2) The ground is flat and level;
 - 3) There is no flammable explosive near to the installation places. The optimal ambient temperature is $15^{\circ}\text{C} \sim 30^{\circ}\text{C}$;
 - 4) Keep away from dust and messy zones.

4.1.2 Tools

The following tools and meters that may be used for installation



Screwdriver (word, cross)



Inclined pliers



Wrench



Needle nose pliers



Wire stripper



Clamp meter



Insulating tape



Multimeters









4.1.3 Technical Preparation

Devices connected directly to the battery can be user equipment, power supplies, or other power supplies.

- Confirm whether the user equipment, the PV equipment or other power supply equipment has the DC standby interface, and measure whether the output voltage of the standby interface meets the requirements of the voltage range;
- Verify that the maximum discharge current capacity of the user equipment, the PV equipment or other power supplies, the DC standby interface, and the maximum discharge current shall be greater than the maximum charging current of the products;
- If the user equipment DC prepared interface maximum discharge capacity is less than the maximum charging current product, the user interface should have the power equipment of DC limiting function, prioritizing the normal work of user equipment.
- Firefighting equipment, such as portable dry powder fire extinguishers, should be provided near the equipment.
- An automatic fire fighting system shall be provided for the case where necessary. No flammable, explosive or other dangerous articles are placed beside the battery.

4.1.4 Open the Package and Inspection

- When the equipment arrives at the installation site, loading and unloading should be carried out according to the rules and regulations, so as to prevent from being exposed to sun and rain.
- Before unpacking, the total number of packages shall be indicated according to the shipping list attached to each package, and the case shall be checked for good condition
- In the process of unpacking, handle with care and protect the surface coating of the object.
- Open the package, the professional installation person should read the technical documents, verify the list, according to the configuration table and packing list, and ensure objects are complete and intact. If the internal packaging is damaged, it must be inspected and recorded in detail.

 Battery x 1 pcs	 User Manual x 1 pcs	 Test report x 1 pcs	 Battery cable x 1 pair
 M6*50 expansion bolt x 8 pcs	 Wall mounted bracket x 1 pcs	 Floor mounted feet (Optional)	 Warranty Terms and Conditions x 1 pcs
 Certificate x 1 pcs			

4.2 Installation

4.2.1 Pack Installation Requirement

PACK has two interfaces: positive and negative power terminals and communication interfaces. Since the system works under high voltage and high current conditions, the high and low voltage interfaces must be connected in a safe and reliable way:

- The connecting cable/busbar shall meet the requirements of the maximum continuous charging and discharging current;
- Each joint must be safe and reliable to ensure that there will be no loose, virtual contact problems, close to zero contact resistance, joint must have corrosion resistance, wear resistance, vibration resistance;
- All kinds of connections must meet the requirements of relevant national standards, strictly prevent all forms of arc discharge;
- Strictly prevent any form of short circuit in the process of connection;
- All the power connections in the battery pack must be adequately insulated to ensure that the positive and negative terminals of the battery will not contact the outer box and cause leakage or short circuit under any circumstances. At any time, it must be absolutely guaranteed that the positive and negative terminals of the battery system will not directly short circuit, otherwise it may cause major safety and electric shock accidents.
- It is strictly prohibited to operate with bare hands without wearing protective equipment.
- All connections must be made under clear guidance, and any form of conjecture and fuzzy attempt are strictly prohibited;

- The key points of connection are as follows: Ensure that the connection is correct, reliable (not loose), good contact, and no short circuit in the whole process;
- After the connection is completed, it must be measured and confirmed point by point;
- All connection points must ensure that no contact with the outer box or other parts, short circuit;
- If there are other uncertain factors, it is necessary to consult professionals to confirm before implementation.

4.2.2 Installation Step

- **Step 1:** Draw the screw hole positions on the wall;
- **Step 2:** Fixing the expansion bolt M6 into the hole on the wall, and fix the support bracket and battery wall back bracket on the wall with M6 bolts;
- **Step 3:** Fixing the battery back bracket on the battery by M8 screw;
- **Step 4:** Connect the battery power cable to the inverter;
- **Step 5:** Carry of hoist the battery to the installed battery on wall mounted bracket
- **Step 6:** Connect the communication cable to the inverter;
- **Step 7:** Set the dipswitch for protocol and battery address;
- **Step 8:** Inverter parameter setting;
- **Step 9:** Close the battery breaker;
- **Step 10:** Turn on the battery and check the battery condition;

4.2.3 Connection Diagram

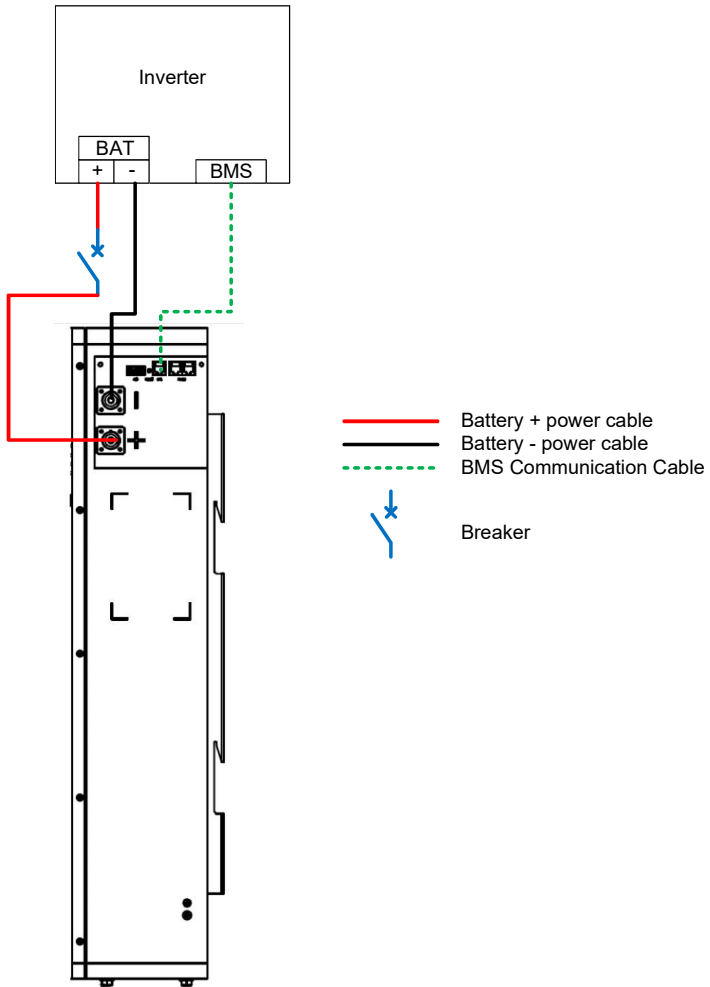

Fig. 4-1 Single MOON10-W PACK + single inverter diagram

Notes:

1. The breaker is recommended between the battery power output and inverter battery input terminal.

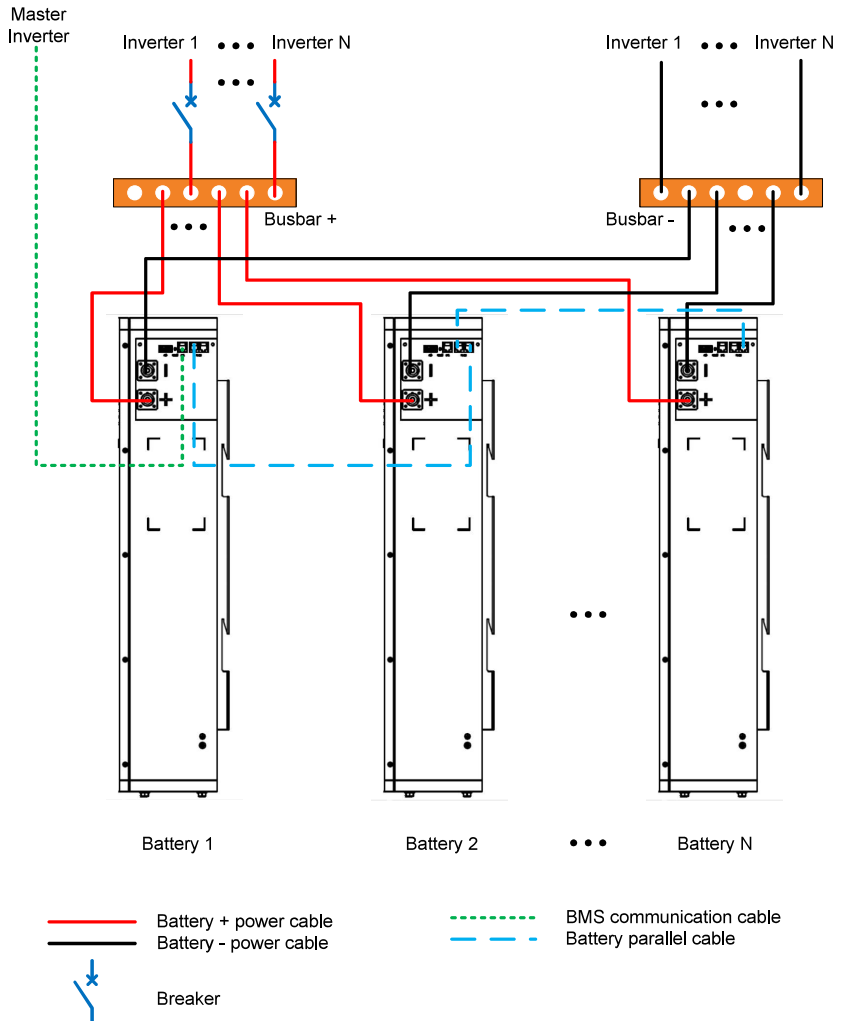

Fig. 4-2 Multi MOON10-W PACK + multi inverter diagram

Notes:

1. The breaker is recommended between the battery power output and inverter battery input terminal.

5. Transportation and Storage

5.1 Transportation

During transportation, it should be protected from violent vibration, shock, sun exposure, and rain and must not be inverted to ensure that no short circuit occurs. In the process of loading and unloading, it should be handled with care to prevent falling, rolling, heavy pressure, and inversion.

5.2 Storage

Product storage requirements are as follows:

- When the battery PACK is long time stored, the battery should be charged to 60% SOC.
- Electrical box products should be stored in a dry and ventilated environment with a temperature not exceeding 50°C and relative humidity less than 80%. For inflammable and explosive items, avoid places with a lot of dust and metal powder, and avoid contact with acid or other corrosive gases;
- The storage location of electric box products should be protected from rain, moisture, and sun protection.
- Storage temperature: The storage temperature range is -10°C~35°C. If it is expected to be stored for more than 1 month and not more than 6 months, you should do a charge and discharge in advance and adjust the SOC to 20% to 50%. Zhejiang Chisage New Energy Technology Co., Ltd. will not be responsible for the loss of capacity or other losses if the storage SOC exceeds the range of 20-50% or the storage for more than 6 months without charge and discharge maintenance.

6. Operation and Maintenance

6.1 Accident Handling

When an exception or accident occurs to the battery set, take proper and effective measures in time to prevent further damage and loss.

Overheat:

Under normal circumstances, when the battery overheats and cannot be cooled to the target temperature within the specified time or the temperature of the battery exceeds the safe use limit, the management system should give a warning and require the battery to stop use immediately. In this case, the battery should be stopped immediately and the relevant technical personnel should be informed to carry out a comprehensive inspection and troubleshoot before continuing to use.

Electric Leakage:

In the process of use, if the battery leakage phenomenon is found, the surrounding personnel must be evacuated immediately, and immediately notify the relevant technical personnel on site to deal with the problem, before continuing to use, it is forbidden to work with the battery disease, forced to continue to use.

Overdischarge:

When the battery pack is used up, the overall voltage is too low or the voltage of some batteries is lower than the normal operating voltage range, the management system should give a warning and require the battery to stop using immediately. In this case, the discharge of the battery should be stopped immediately and the battery should be charged. Do not discharge the battery forcibly at this time. It will damage the performance of the battery. In serious cases, the battery may be permanently damaged and cannot be used any longer.

Short Circuit:

In the case of battery short circuit caused by various reasons, the surrounding personnel must be evacuated immediately, the relevant power supply and electrical equipment should be cut off (if possible), the connection between the battery and the system should be disconnected immediately, and the relevant technical personnel should be informed immediately on site to repair and troubleshoot the fault. The battery that has been seriously short-circuited cannot be used again and must be comprehensively tested by the manufacturer. Before deciding whether part of the maintenance can be continued.

Combustion:

In case of battery set burning accident caused by various reasons, the surrounding personnel must be evacuated immediately. Meanwhile, no irrelevant personnel shall be allowed near the accident site within the safety range (due to the possibility of explosion). After extinguishing the fire, the personnel wearing necessary protective equipment shall first cut off the power connection line. Only when the resistance of the battery pack is fully discharged (the voltage

reaches zero volts), remove the battery pack for subsequent analysis.

Battery Collision:

If the battery is collided, deformed or impaled by foreign matter due to various reasons, disconnect the power cable of the battery immediately and notify professional technicians to handle it on site. If the battery needs to be removed, the personnel wearing necessary protective equipment should discharge the battery fully before removing the battery.

Other Accidents:

When the battery system needs to be repaired or removed due to other accidents, disconnect the battery circuit first to ensure that the battery will not be short-circuited, and remove the battery pack to ensure that the battery pack will not be damaged by collision, fall, upside down, etc. If such a situation occurs, please refer to the above provisions for handling.

If necessary, you can consult the after-sales service staff of Zhejiang Chisage New Energy Technology Co., Ltd.

6.2 Maintenance

The customer is obligated to prepare a reasonable maintenance plan, such as monthly dust removal, battery performance check, software adjustment, etc., to ensure the normal use of the product.

- PACK maintenance cycle: 3 months/time is recommended (maintenance record form is required)
- PACK maintenance method: Charge with charging and discharging equipment to ensure that the battery power is maintained at 10%SOC~90%SOC.
- Notes for charging: 1) Special charging/discharging equipment must be used 2) equipment precision voltage < 0.15%, current < 0.35% 3) Operation must be strictly in accordance with the charging process.
- As for discarded products, they should be immediately recovered by the designated qualified manufacturers. It is strictly prohibited to discard them at will, which may lead to safety accidents or serious environmental pollution.

Zhejiang Chisage New Energy Technology Co., Ltd.

 Tel: +86 150 5749 1826

 Email: info@chisagess.com

 Web: www.chisagess.com

 Add: No.1828, Fuqing South Road, Panhuo Street, Yinzhou District, Ningbo City,
Zhejiang Province, China 315000
