



Influence of oxygen and humidity on quality and mechanical properties of AlSiMg parts processed by Laser-PBF

LeadIng.



THE LINDE GROUP

Juergen Scholz, Linde AG Linde Gases
Division

Anders Astrom, AGA Gas AB

1 Introduction - Motivation

2 Parameters in AM – The way to reproducibility

3 Results of AlSiMg

4 Conclusion & Outlook

Gases Division

THE LINDE GROUP

Linde



Global Development Center Additive Manufacturing created in 2015:
Develops new solutions for the Additive Manufacturing industry along the value chain (Powder production/storage, Selective Laser Melting, Laser Metal Deposition, Wire Arc AM, post-treatments)

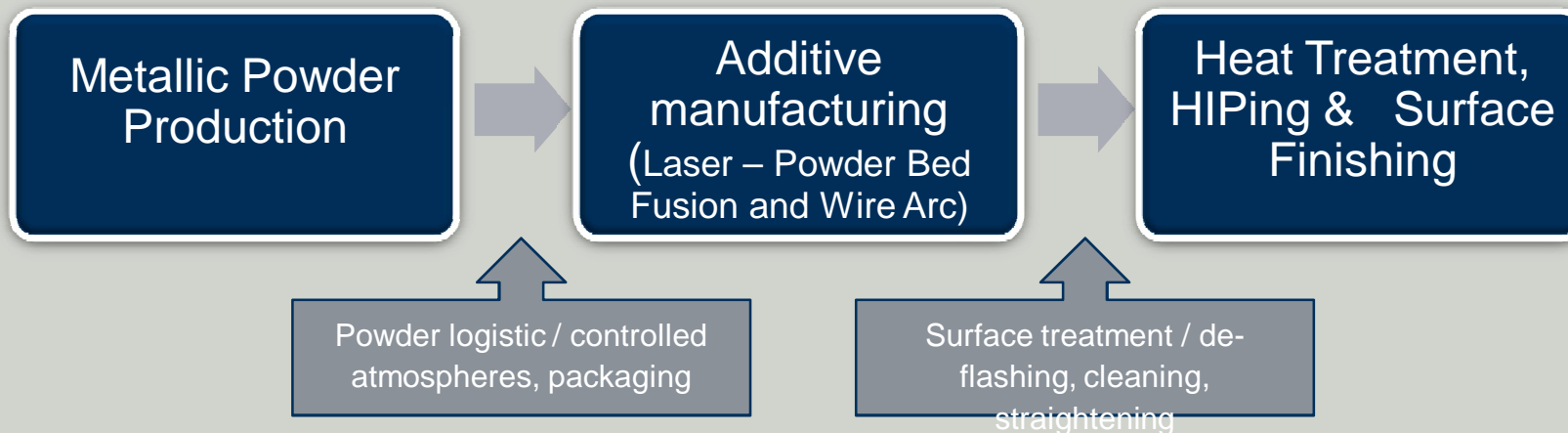

Critical capabilities:
metallurgy, chemistry and physics of gas-to-metal interfaces, gases safety and engineering

GDC Additive Manufacturing

AM Lab Uheim – Capabilities

EOS



Purpose:

In-house process development
Part production

Features:

- Build surface 250*250*350mm
- 400W Laser

Powder handling

- Powder storage
- Powder commissioning
- Post Processing
- Surface Finish

Clean Room / Analytics

- Powder characterisation (SEM, Revolution, CAMSIZER X2)
- Testing, Metallography
- *Chemical Analysis*
- Gas Analytic

Trumpf TruPrint 1000



Purpose:

Process development & Demo and internal training

Features:

- Build surface \varnothing 100mm
- 200W Laser



RAP, Source: Mercury Scientific

Additive Manufacturing for Linde technologies

Example Hydropox burner (glass surface treatment)

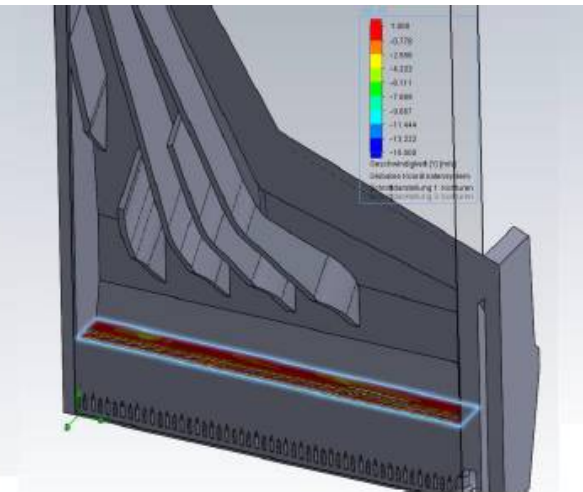
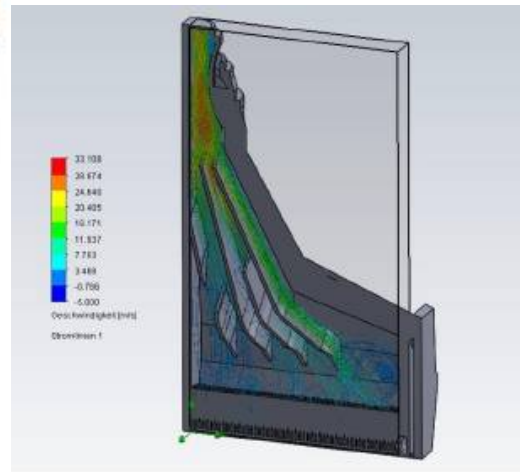
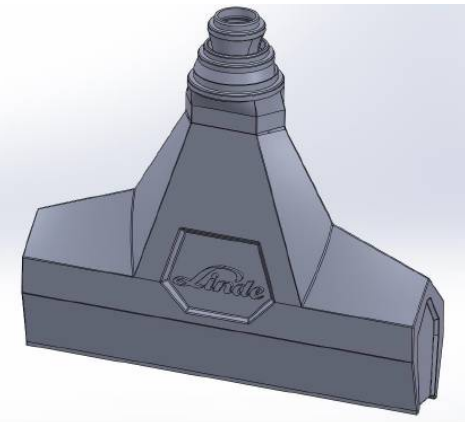

During L-PBF, material experiences a unique thermal profile

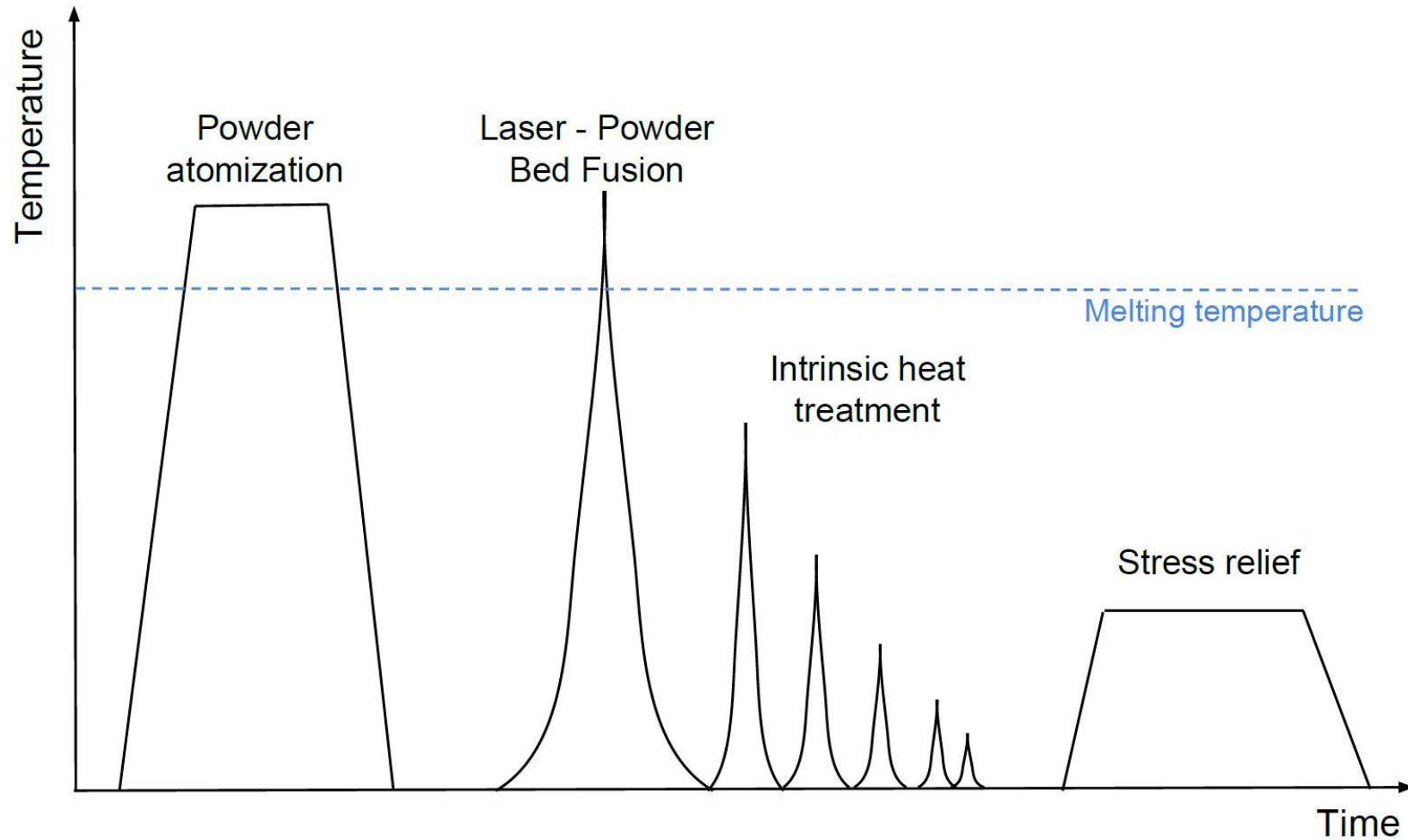

Evolution of grain structure during laser additive manufacturing

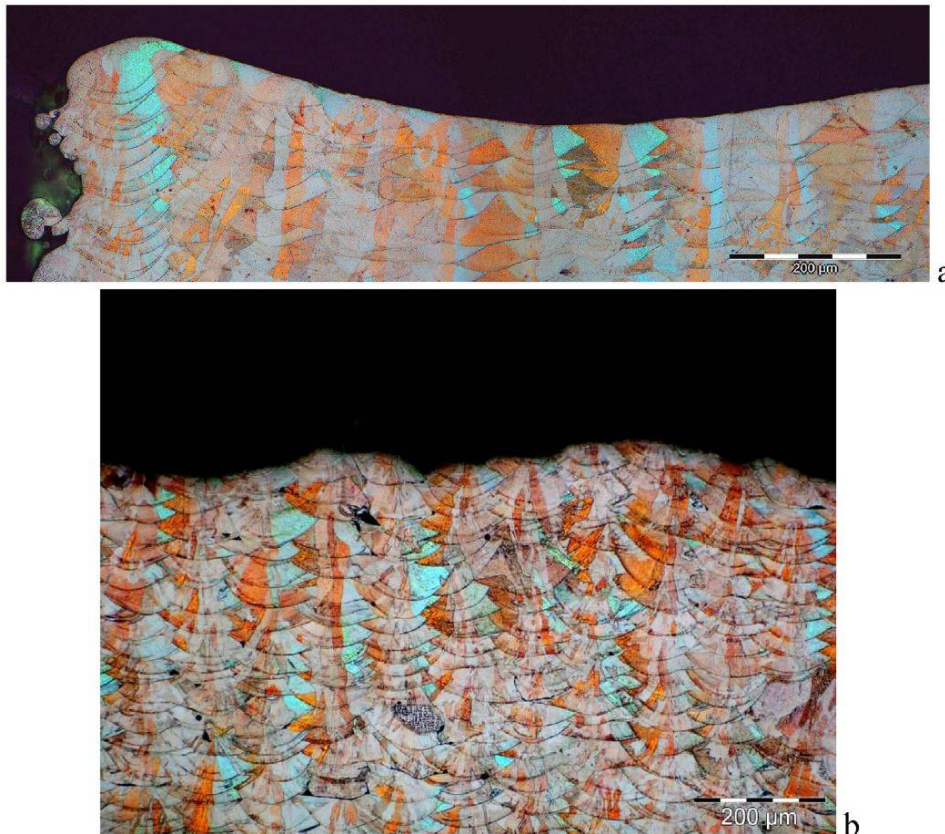

- Fine microstructure: rapid solidification => enhanced strength, properties comparable and/or surpassing conventional material
- Columnar microstructure with texture along the building direction
- Anisotropy : lower strength along the building direction due to superposition of layer

Fig. 8. Experimental grain structures of 316 L steel subjected to the SLM process. Experiments were performed in Neue Materialien Bayreuth GmbH.

1 Introduction - Motivation

2 Parameters in AM – The way to reproducibility

3 Results of AlSiMg

4 Conclusion & Outlook

Challenges for aerospace materials and processes:

- Low mass
- Small production series
- Very high reliability
- Very high performances

Why AM?

- AM addresses majority of above challenges

BUT quality and reproducibility are key



Additive Manufacturing sounds easy ...



+



+



=

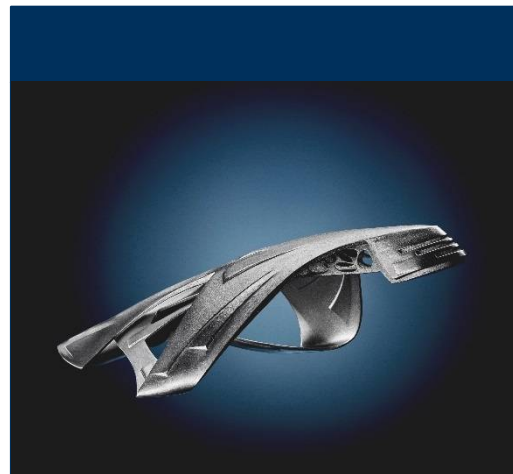

Which parameters influence the end product quality

Powder

Flowability, Particle size distribution, satellites, chemical composition, fine particles, morphology, topology, humidity...

Parameters

Laser power, laser speed, scanning speed, build strategy, hatching distance, layer thickness ...

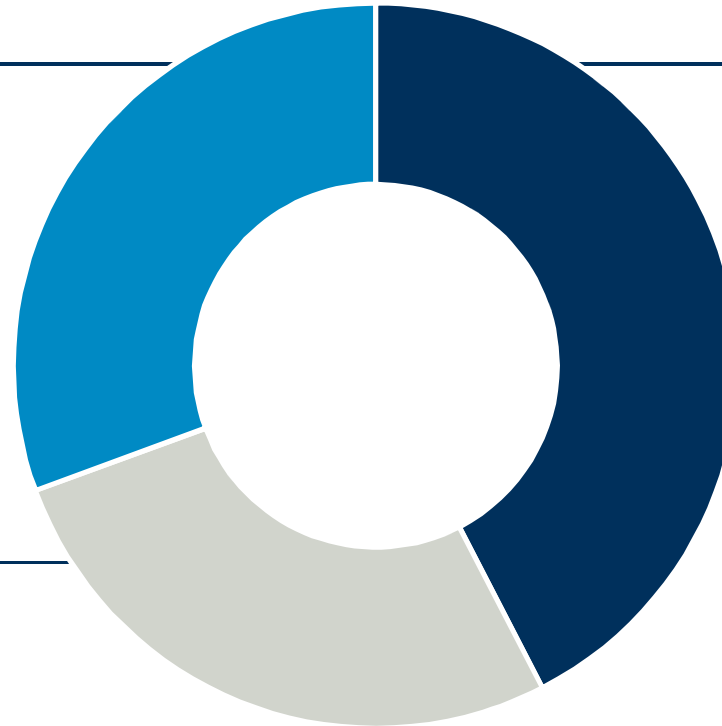

Machine

Laser, scan, software, gas flow, chamber size, recoating strategy ...

Which parameters influence the end product quality

Powder

Machine

Parameters

Atmosphere

Gas type, gas purity,
humidity, atm.
composition, flow speed,
temperature

Atmosphere composition inside the chamber



THE LINDE GROUP

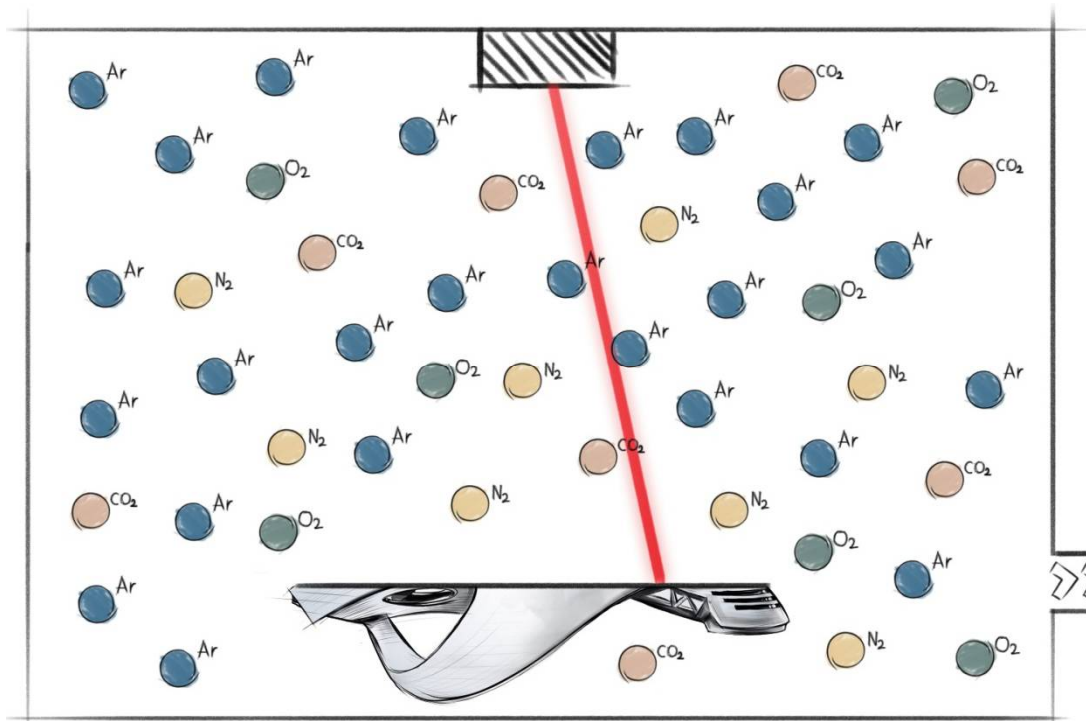

Atmosphere composition:

- Argon or Nitrogen
- Oxygen

And much more:

- H₂O
- Hydrogen
- CO
- CO₂
- Nitrogen
- ...

Atmosphere composition inside the chamber

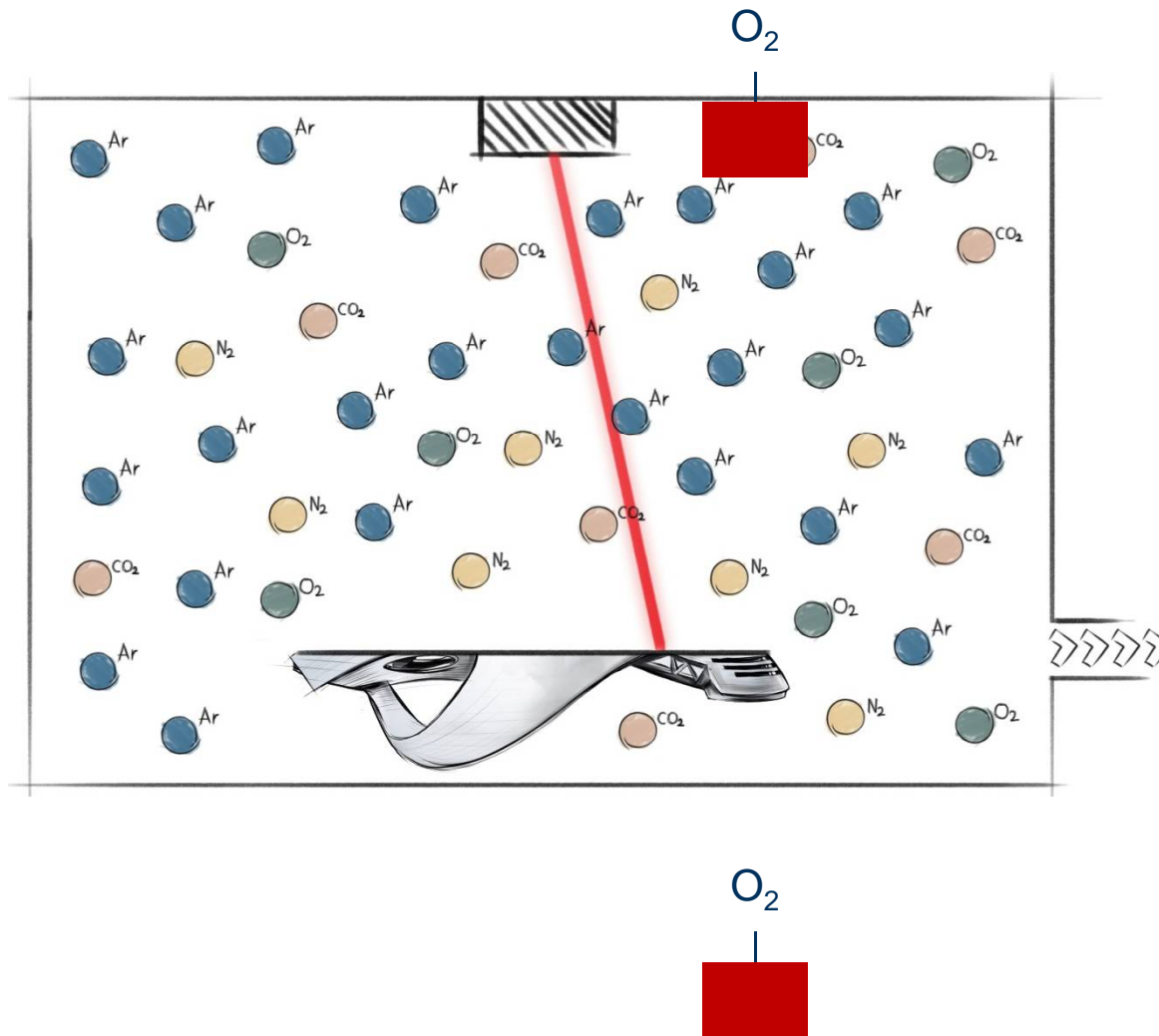

Atmosphere composition:

- Argon or Nitrogen
- Oxygen

And much more:

- H₂O
- Hydrogen
- CO
- CO₂
- Nitrogen
- ...

What is the right amount of oxygen?



In welding 0,005% (50ppm)

In AM 0,1% to 1,5%

1 Introduction - Motivation

2 Parameters in AM – The way to reproducibility

3 Results of AlSiMg

4 Conclusion & Outlook

- 1) Investigate the impact of different **powders** on the final mechanical properties
- 2) Investigate the impact of **oxygen** in the chamber on the final mechanical properties

3 powders from 3 different suppliers

- AlSi10Mg
- Same particle size distribution 20 – 63um

3 oxygen concentration

- 30ppm
- 500ppm
- >1000ppm

Powder

ALU_1



10 µm Hochsp. = 15.00 kV Signal A = SE2
Arbeitsabstand = 8.7 mm Photo Nr. = 20421 Vergrößerung = 100 KX AIRBUS GROUP

ALU_2

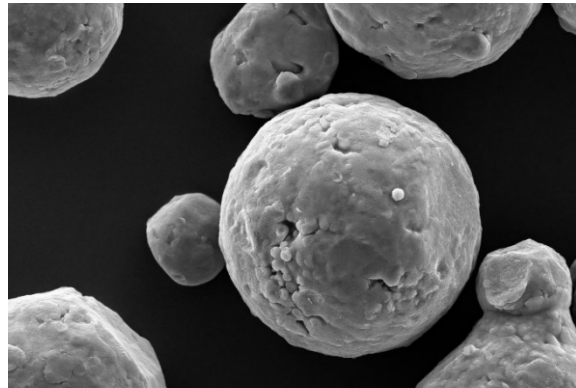

10 µm Hochsp. = 15.00 kV Signal A = SE2
Arbeitsabstand = 8.8 mm Photo Nr. = 20023 Vergrößerung = 100 KX AIRBUS GROUP

ALU_3

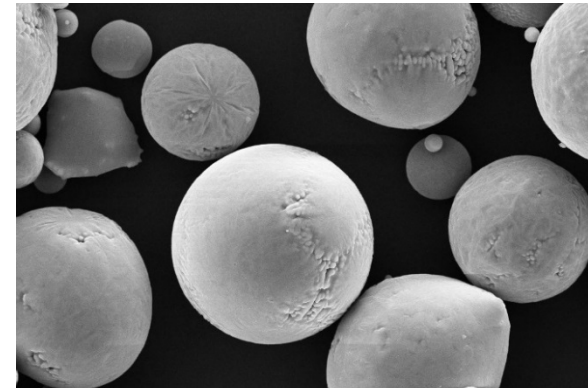

10 µm Hochsp. = 15.00 kV Signal A = SE2
Arbeitsabstand = 8.7 mm Photo Nr. = 34282 Vergrößerung = 100 KX AIRBUS GROUP

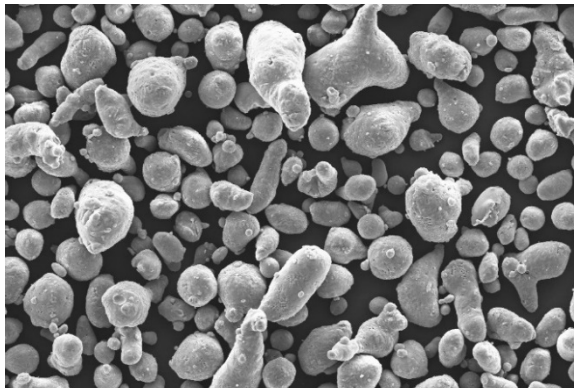

20 µm Hochsp. = 15.00 kV Signal A = SE2
Arbeitsabstand = 8.7 mm Photo Nr. = 20419 Vergrößerung = 250 X AIRBUS GROUP

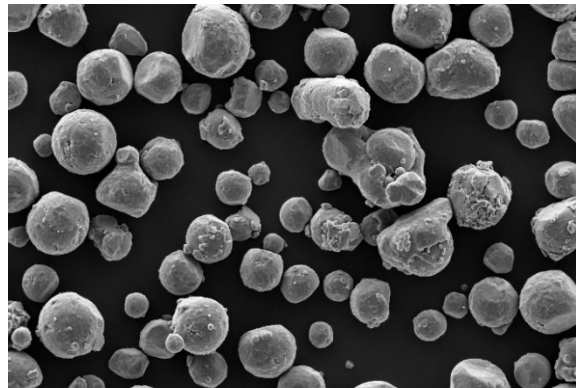

20 µm Hochsp. = 15.00 kV Signal A = SE2
Arbeitsabstand = 8.8 mm Photo Nr. = 20021 Vergrößerung = 250 X AIRBUS GROUP

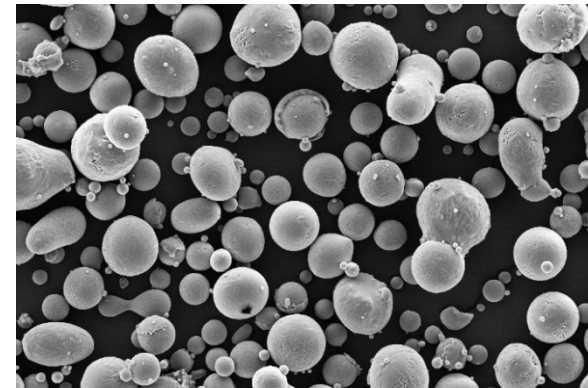

20 µm Hochsp. = 15.00 kV Signal A = SE2
Arbeitsabstand = 8.7 mm Photo Nr. = 34280 Vergrößerung = 250 X AIRBUS GROUP

Chemical composition

Particle shapes



	Rest [%]	Non-Spherical [%]	Spherical [%]
ALU1	3	87	10
ALU 2	1	59	40
ALU 3 <small>Malvern, Morpholgi G3</small>	-	-	High

	Oxygen concentration
ALU1	950
ALU 2	270
ALU 3	230

LECO, TCH600, 5% measurement uncertainty

	Avalanche Angle [°]
ALU1	47.7
ALU 2	48.1
ALU 3	50.9

Revolution analyzer, 600 avalanches per powder

How to compare two powders?

- Chemical composition
- Flowability
- Particle size distribution
- Morphology
- Influence of hole particles
- ...

→ Reproducibility is key!



SLM 125HL

SLM Solutions, Lübeck, Germany
Major SLM machine supplier

Parameters:

- Build volume of 125*125*125mm³
- Single 400W IPG fiber laser
- Build rate up to 25cm³/h
- Layer thickness 20μm – 75μm
- Max. scan speed 10m/s

State of the art use of Argon:

- Purging phase until O₂ content decreases to 0,1%
- Control of chamber overpressure and addition of Argon if the pressure is below 12mbar

Current machines do not monitor/ control accurately the oxygen content

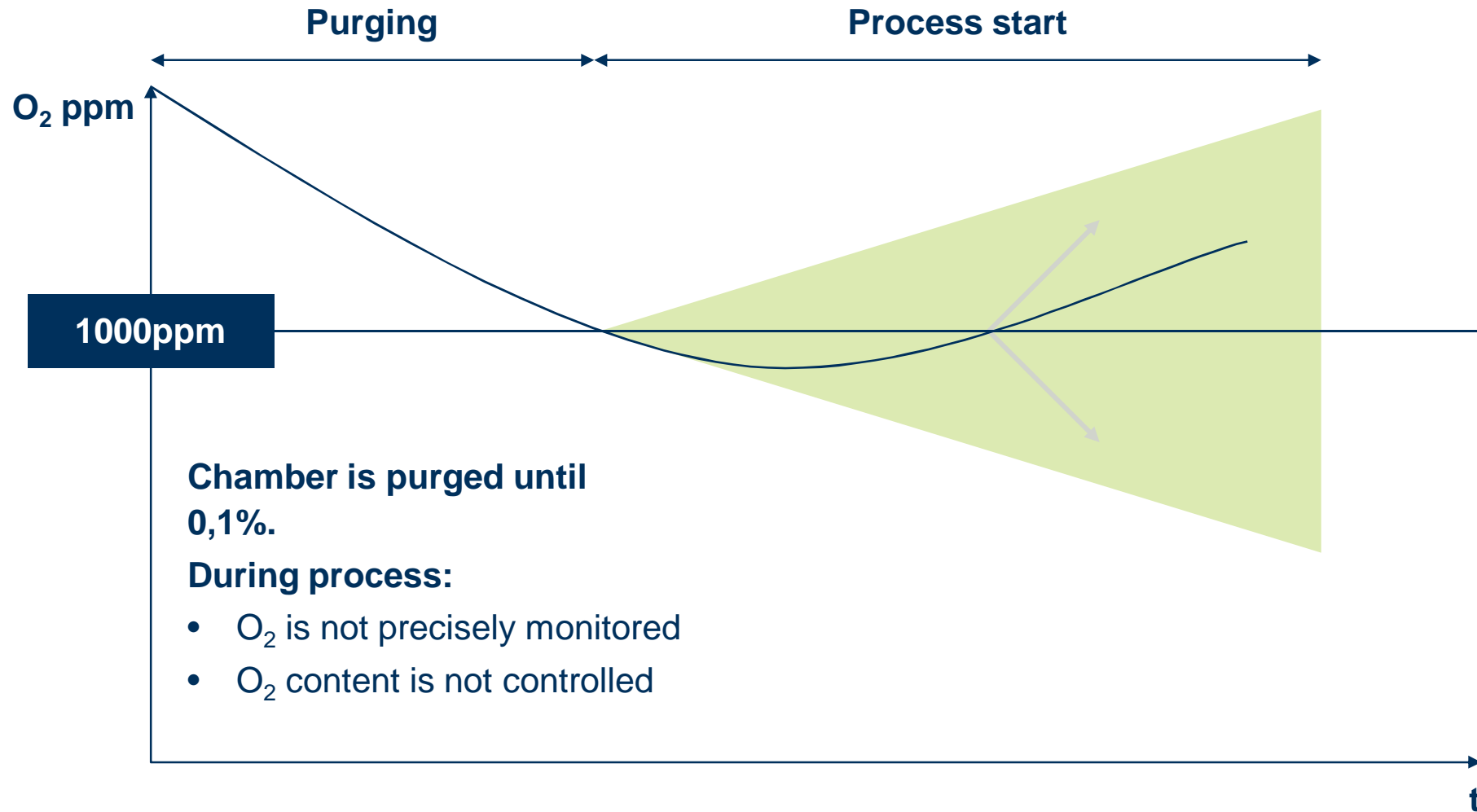

Influence of O₂ in Additive Manufacturing

Oxygen and humidity monitoring and control

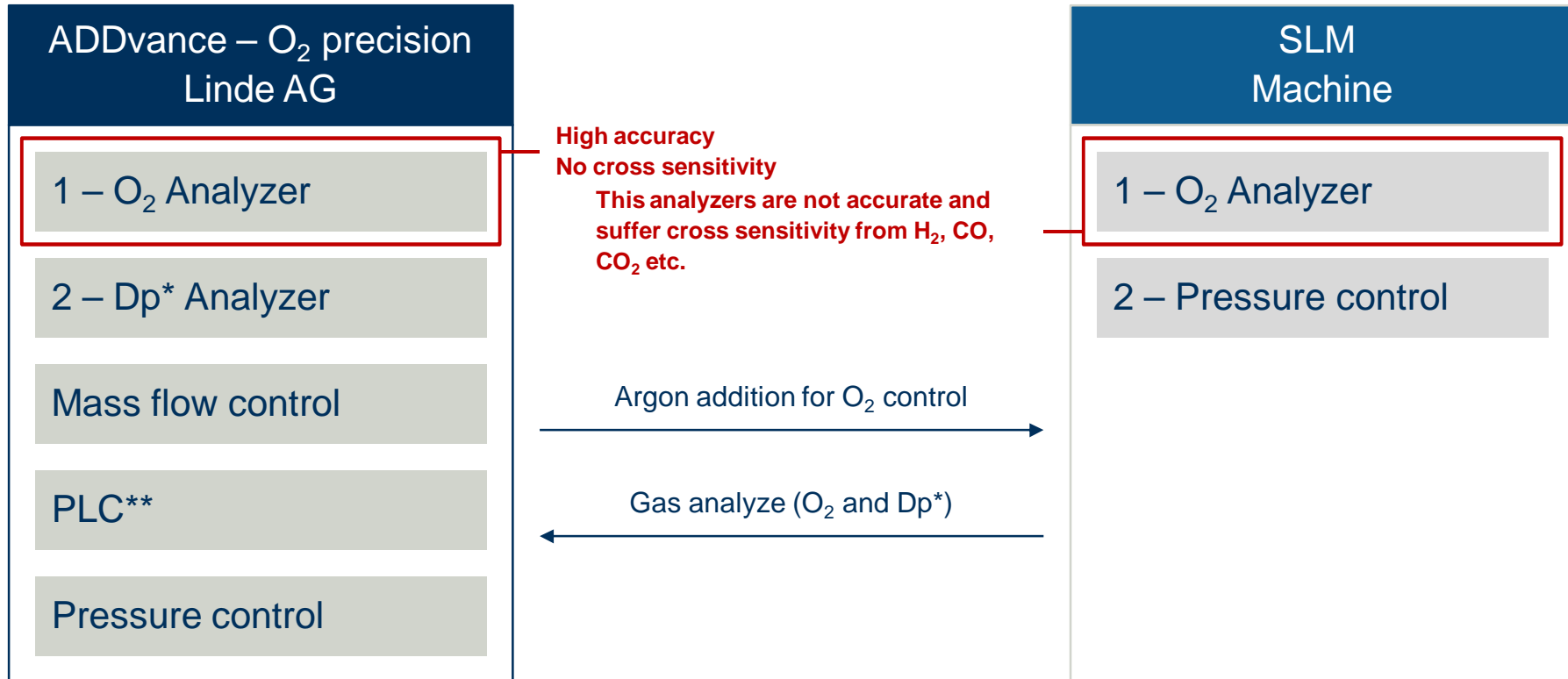

*Dp Dew point | **PLC Programmable Logic Controller

ADDvance O2 precision

Example installation EOS M290



ADDvance – O₂ precision developed by Linde AG

Example of O₂ variation during start

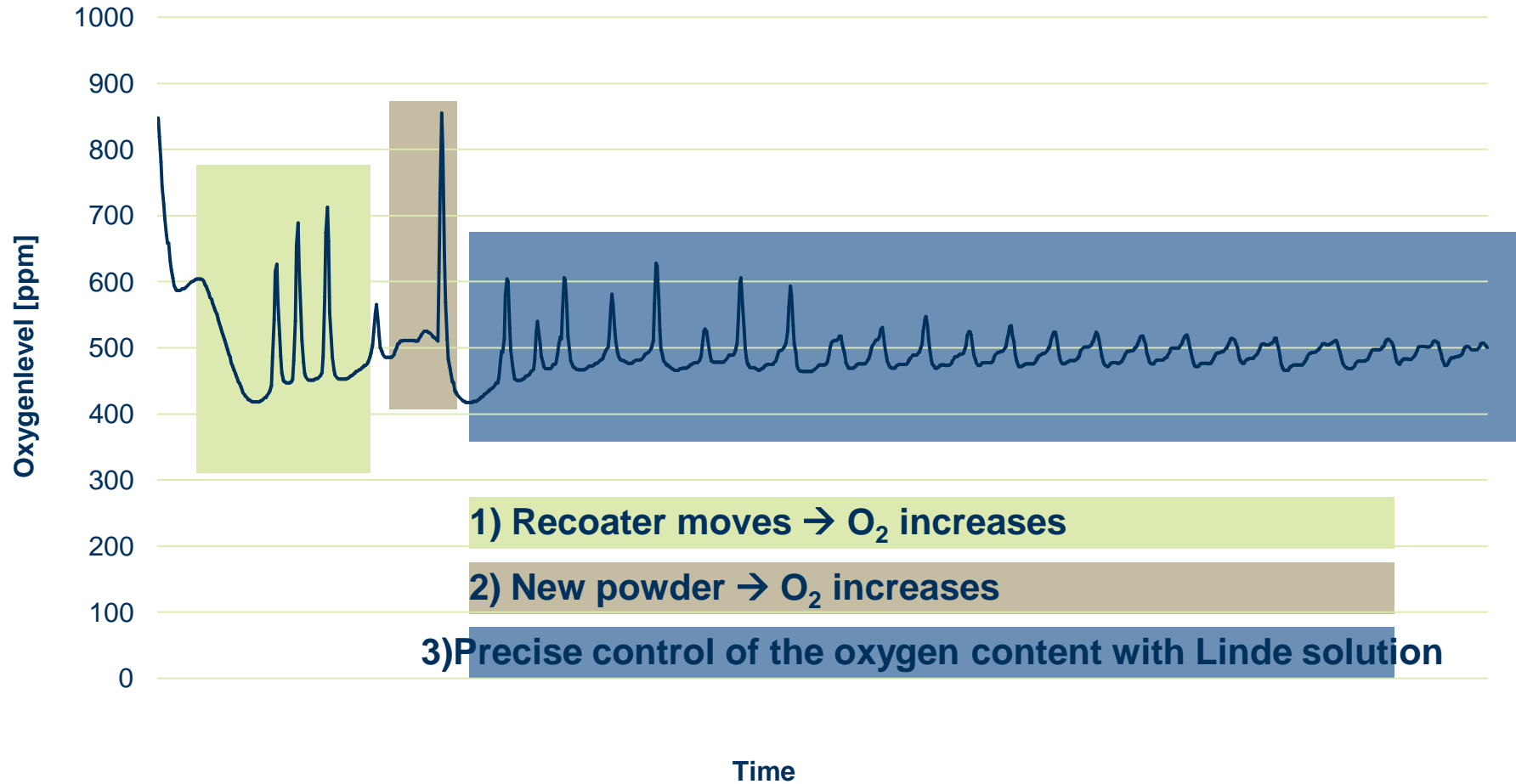

Influence of Oxygen on AlSi10Mg – Surface

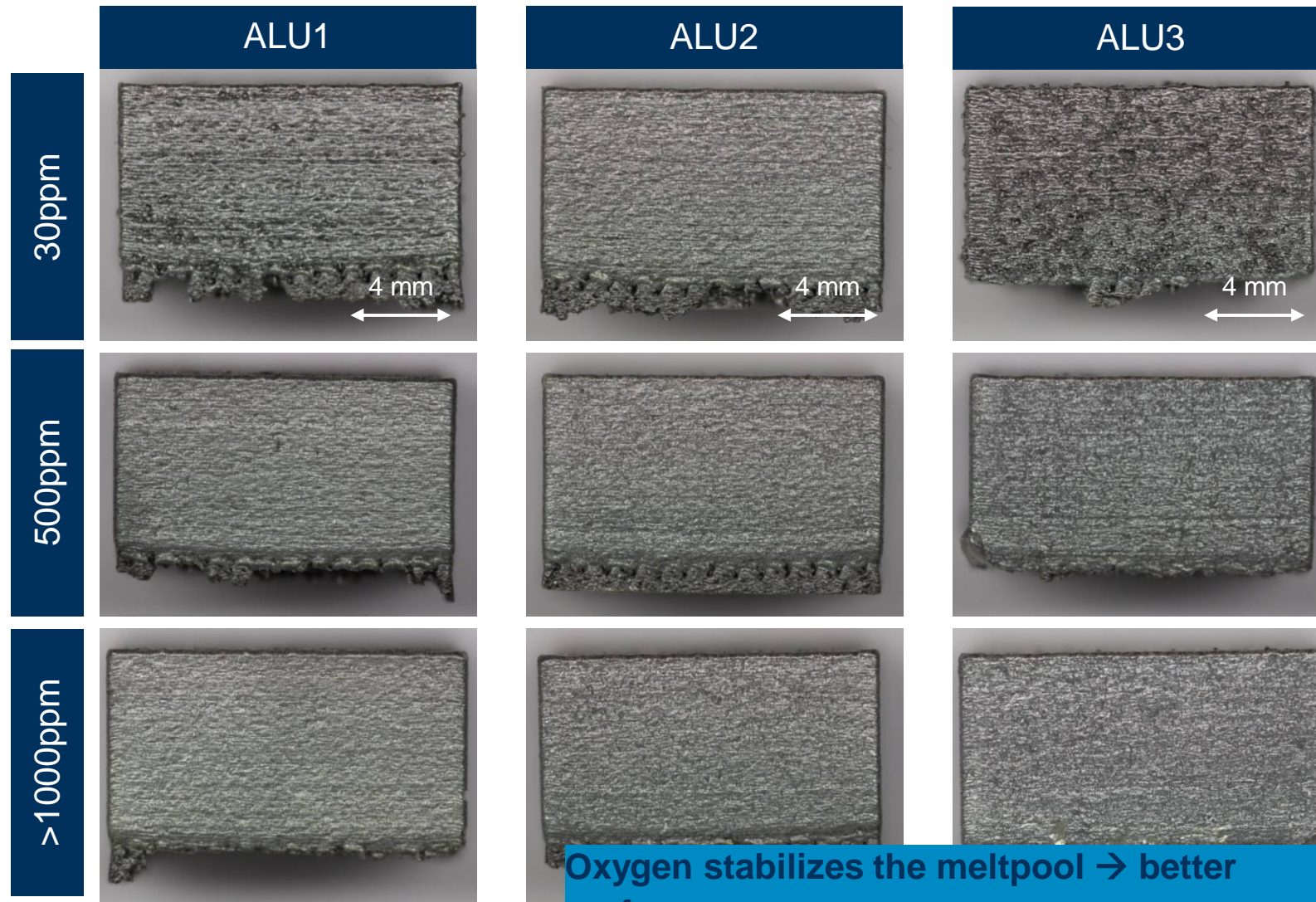

Oxygen stabilizes the meltpool → better surface

Mechanical properties – Rp0,2 and Rm

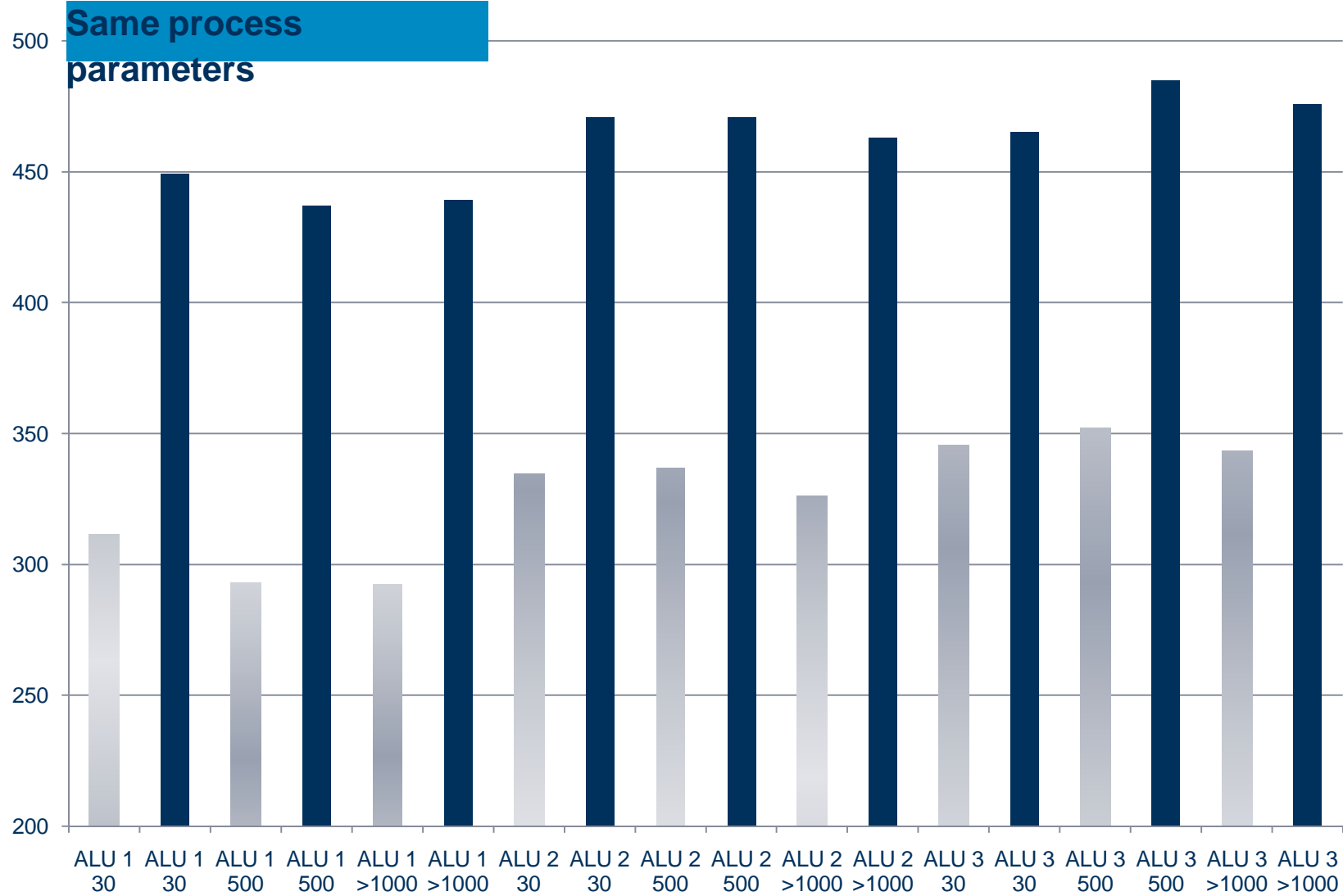

Mechanical properties – Rp0,2 and Rm

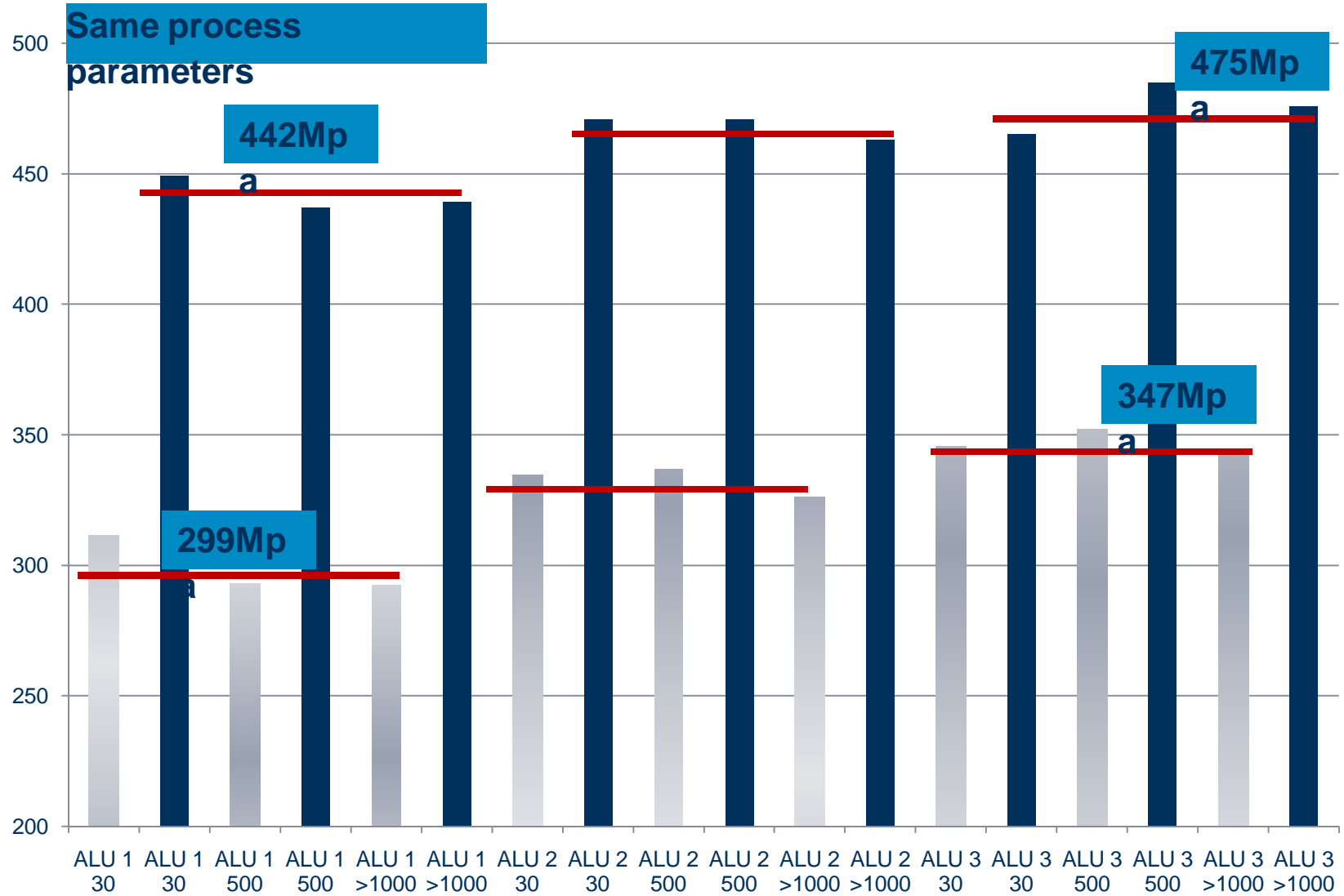

Influence of Oxygen on AlSi10Mg – Density

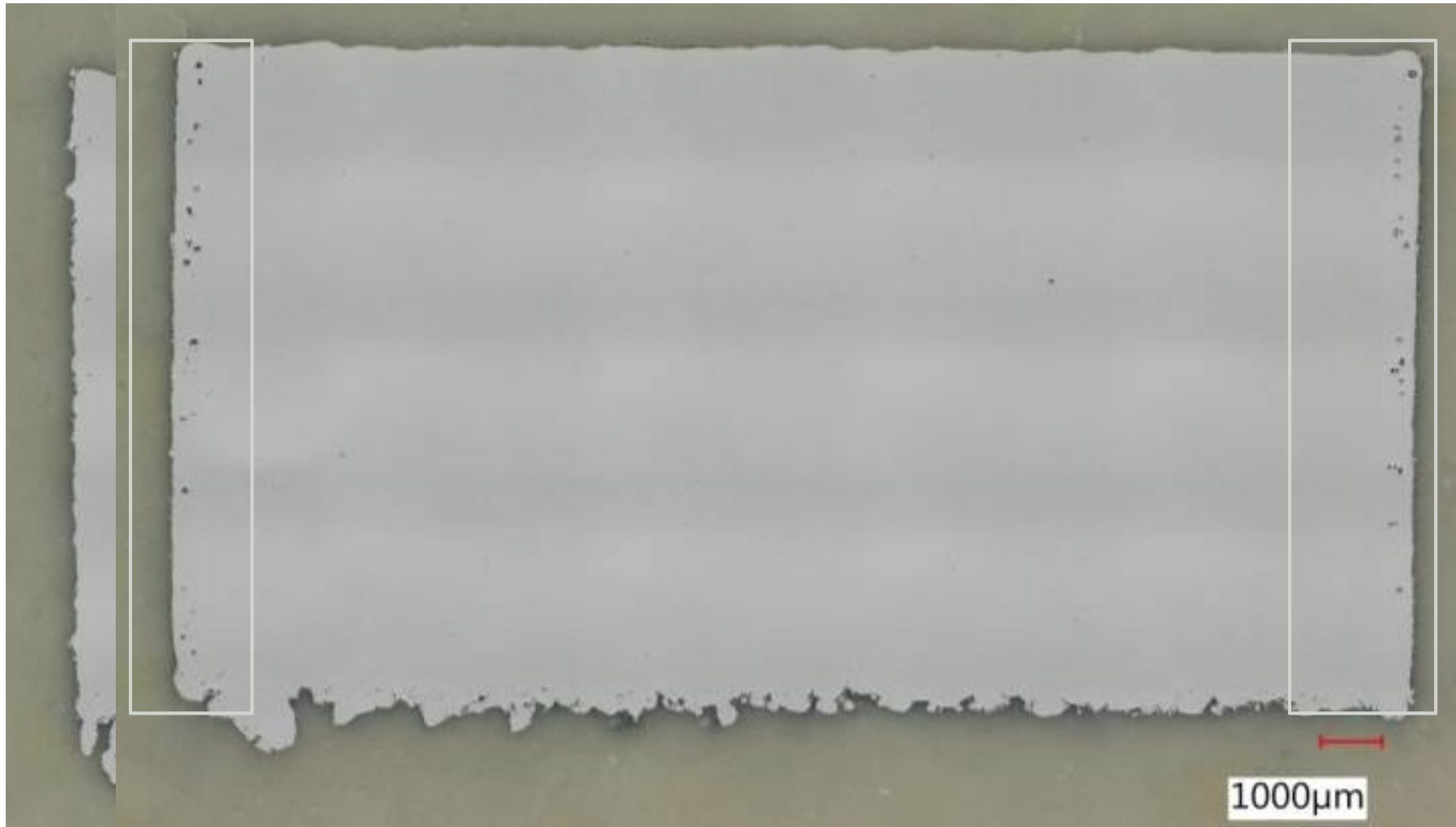

Influence of Oxygen on AlSi10Mg – Fracture analysis ALU_2

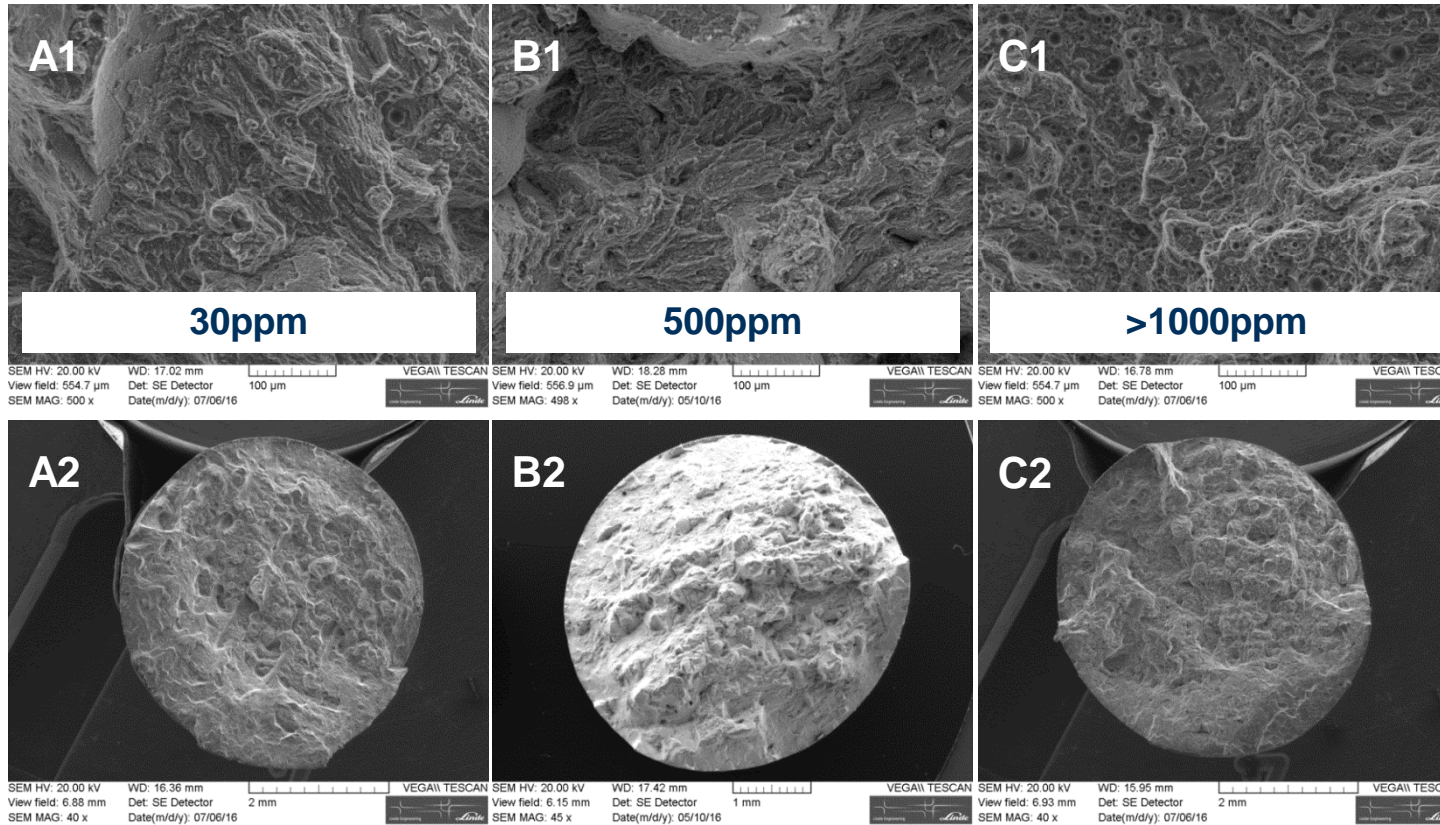

SEM images of the breakage of the tensile strength specimen of [ALU_2]

→ The more oxygen the more gas pores

Influence of Oxygen on AlSi10Mg – Fracture analysis ALU_2 >1000ppm

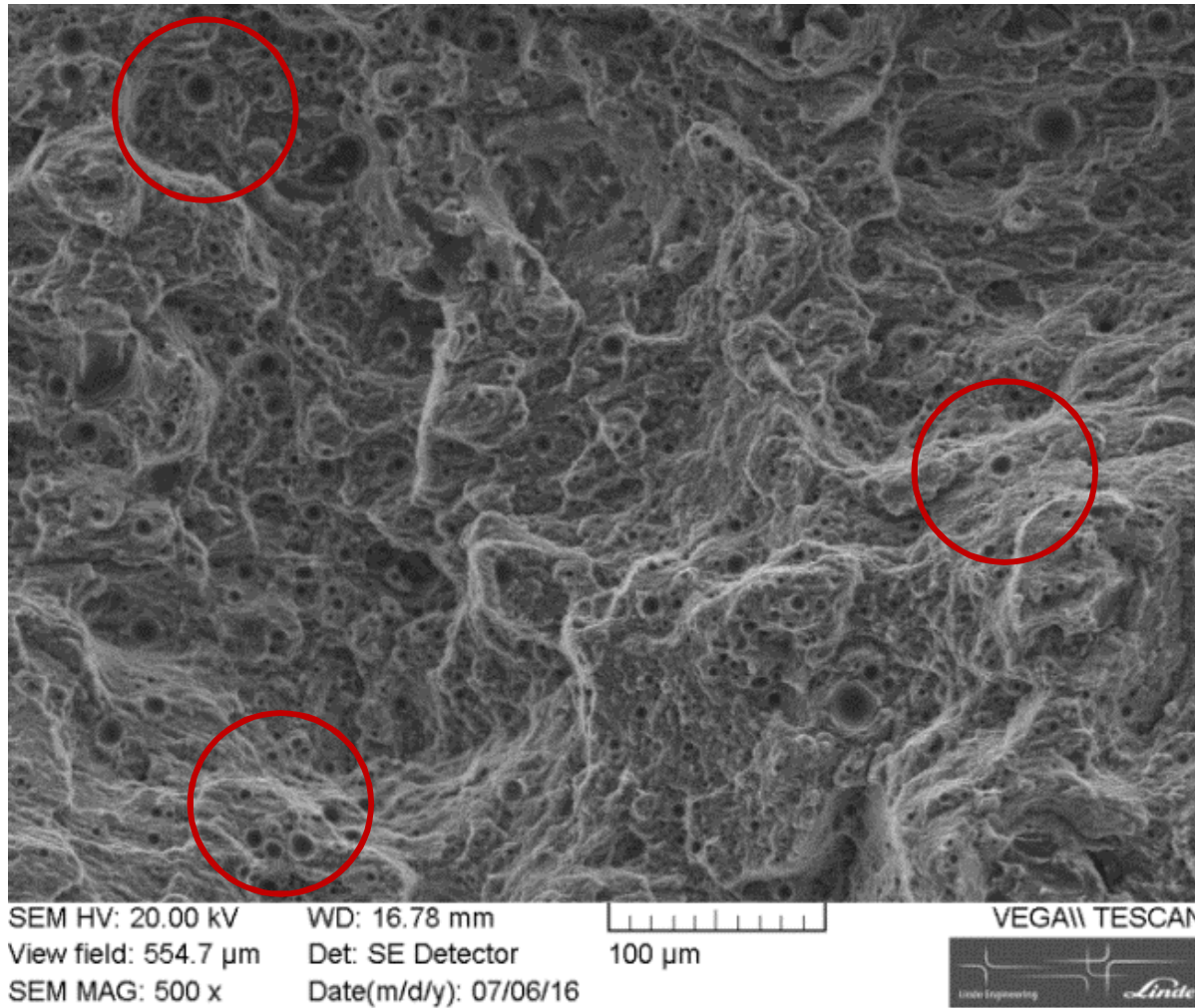

Fatigue test performed by Airbus on AlSi7Mg parts produced with and without our technology

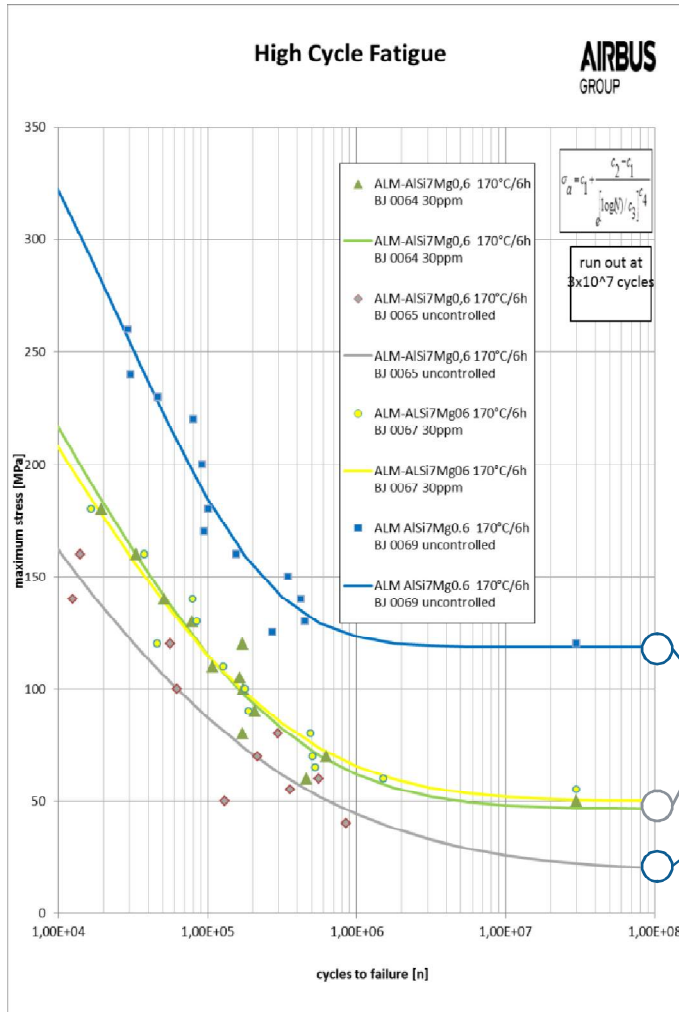

- Reproducible results need an accurate oxygen control
- Process parameters with 30ppm can be optimized to improve fatigue resistance

Yellow and green curves from parts produced with ADDvance™ O₂ precision at 30ppm oxygen 

Blue and grey curves from parts produced without oxygen control 

GDC Additive Manufacturing
Public funded project

THE LINDE GROUP

BADGE B, Germany
Investigate influence of parameters (GAS!) on operational strength
3 years, Total: €4.5m

AIRBUS



BOSCH

Heraeus



The experiments show that:

- AlSiMg parts manufactured by AM for aerospace requires accurate process control to ensure very high product reliability
- the oxygen level inside the chamber plays a significant role on the fatigue mechanical properties of the final part
- the powder characteristics have a clear impact on the final product

Future work will focus on:

- investigating the correlation between oxygen and fatigue resistance of AlSiMg alloys
- optimizing the processing parameters for low O₂ levels with assistance of Addvance™ O₂ Precision.



**Thank you for your
attention.**

LeadIng.

L
THE LINDE GROUP

Juergen Scholz