



BRANNTTEKNISK OPPGRADERING AV GAMLE TREDØRER

SFPE årsmøte 01.03.2023

Anne-Marit Haukø

Brannteknisk oppgradering av gamle tredører



Foto: NIKU

FRIC

FIRE RESEARCH & INNOVATION CENTRE

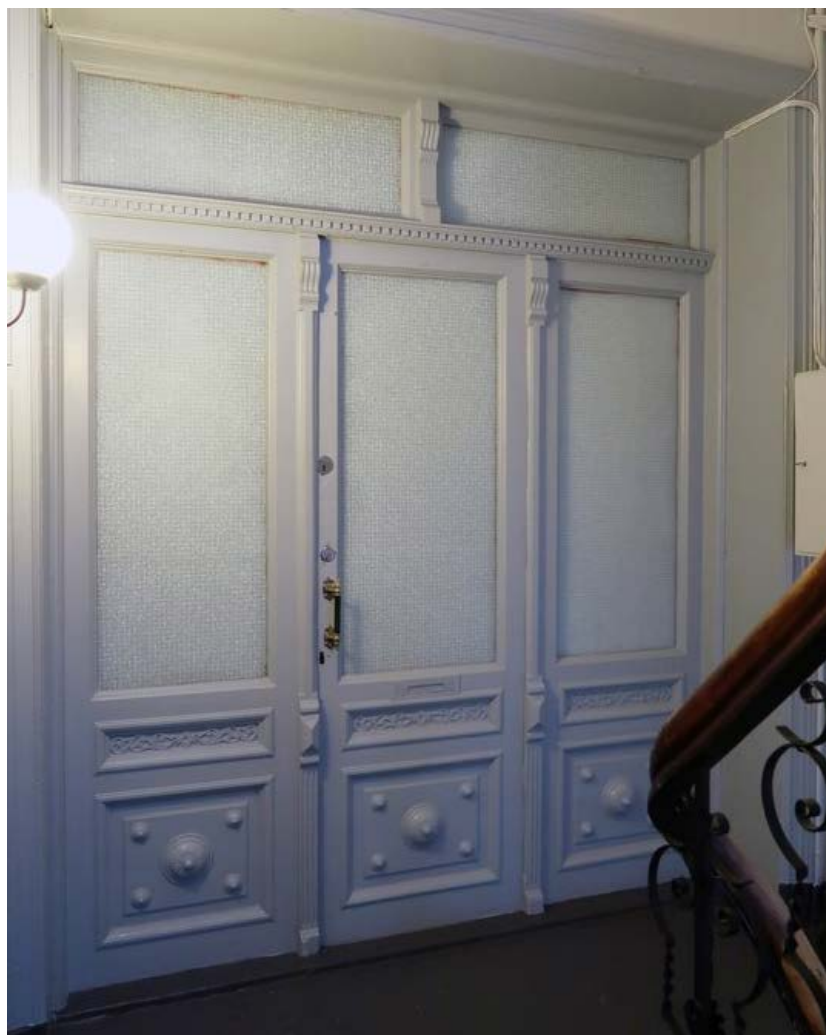

NIKU

Norsk institutt for
kulturminneforskning

RI SE



Branntesting



Guideline

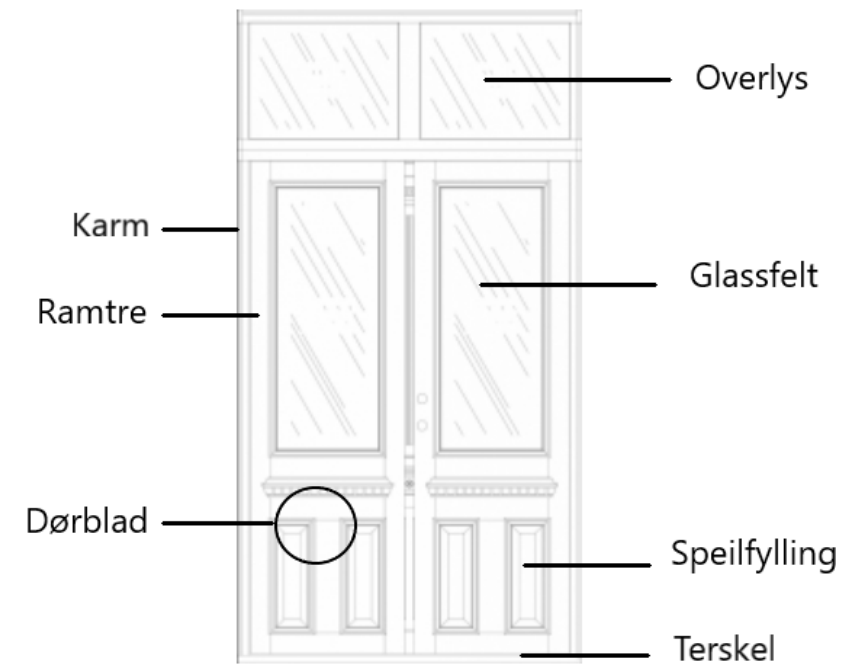

Illustrasjon:
Jømna
Brug/SINTEF

Forutsetninger

- Minste tykkelse 40 mm
- Oppnår brannmotstand på ca. 30 minutter, men ikke sertifisert som EI
- Brannsikkerheten i bygget må vurderes som en helhet, kompensierende tiltak må vurderes

Guideline

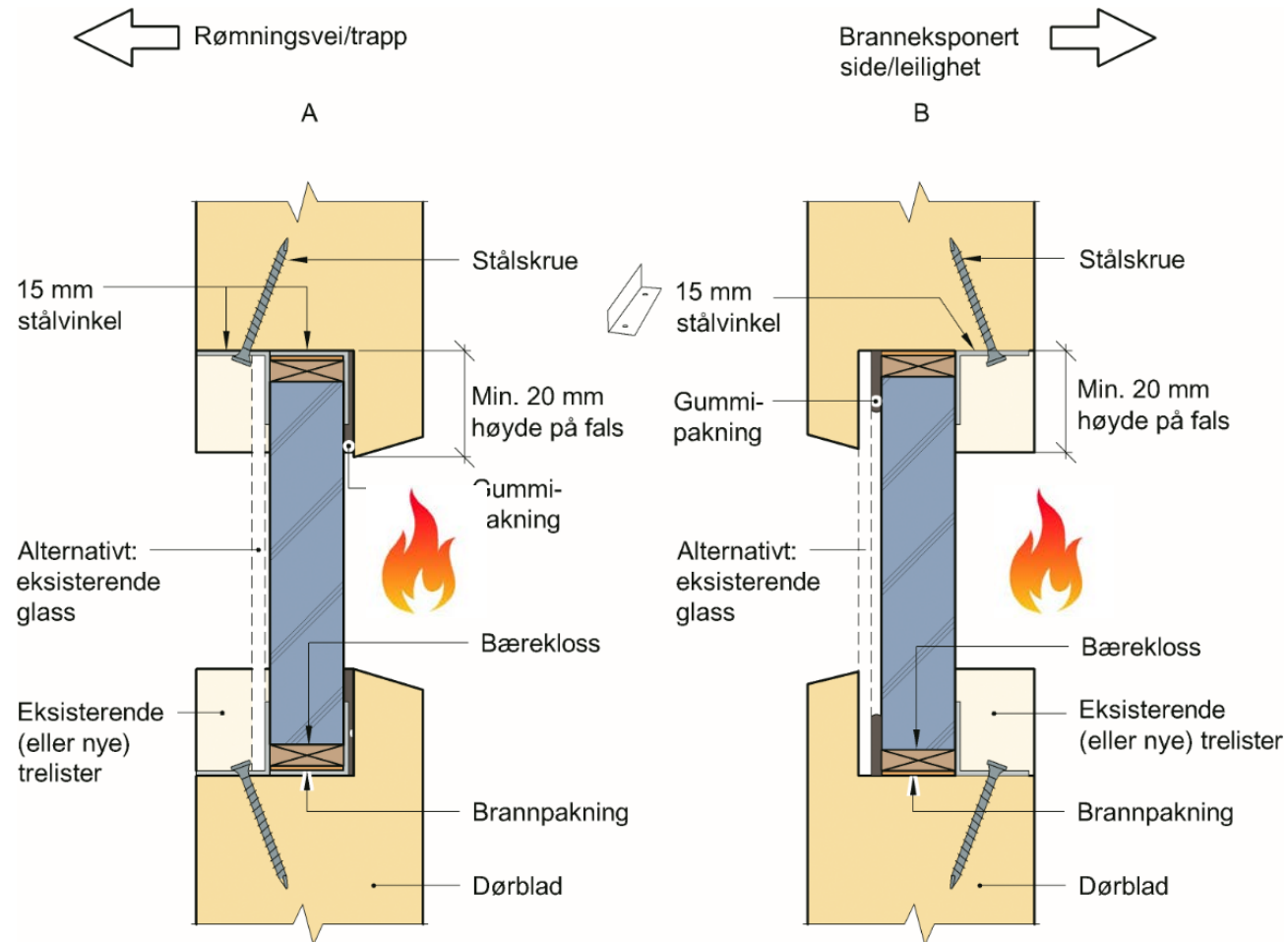

Guideline

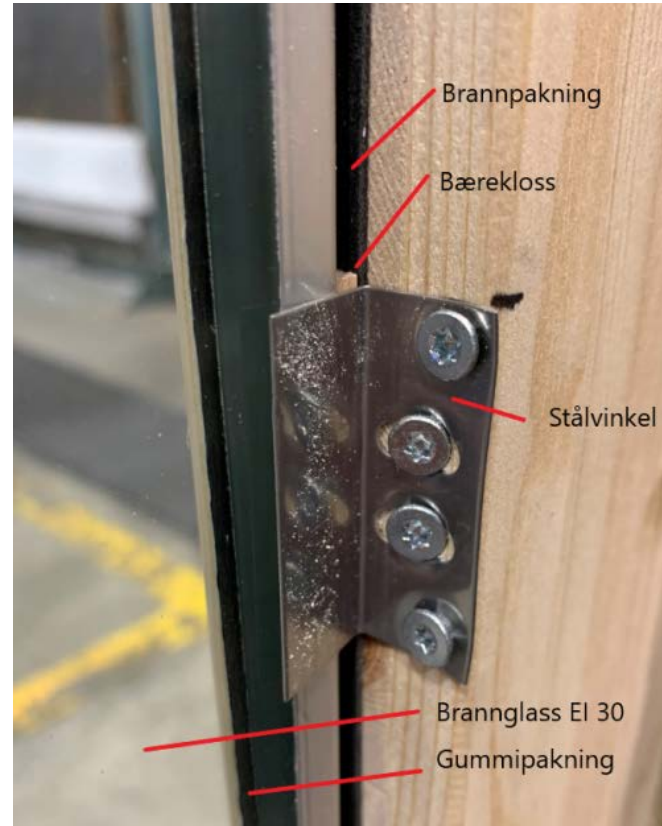

Guideline

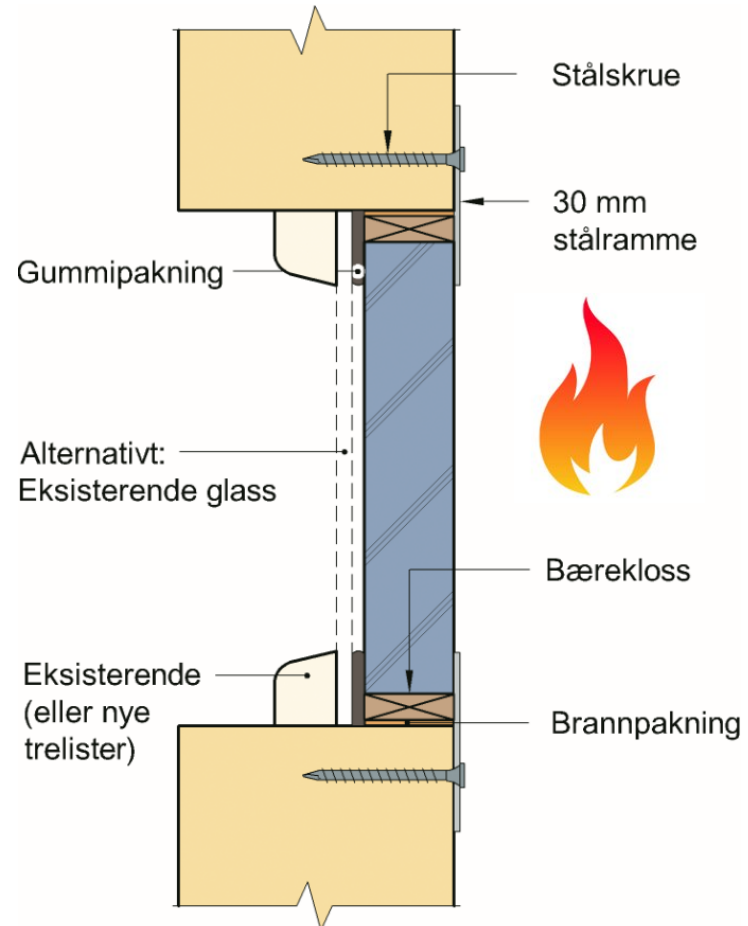

Guideline

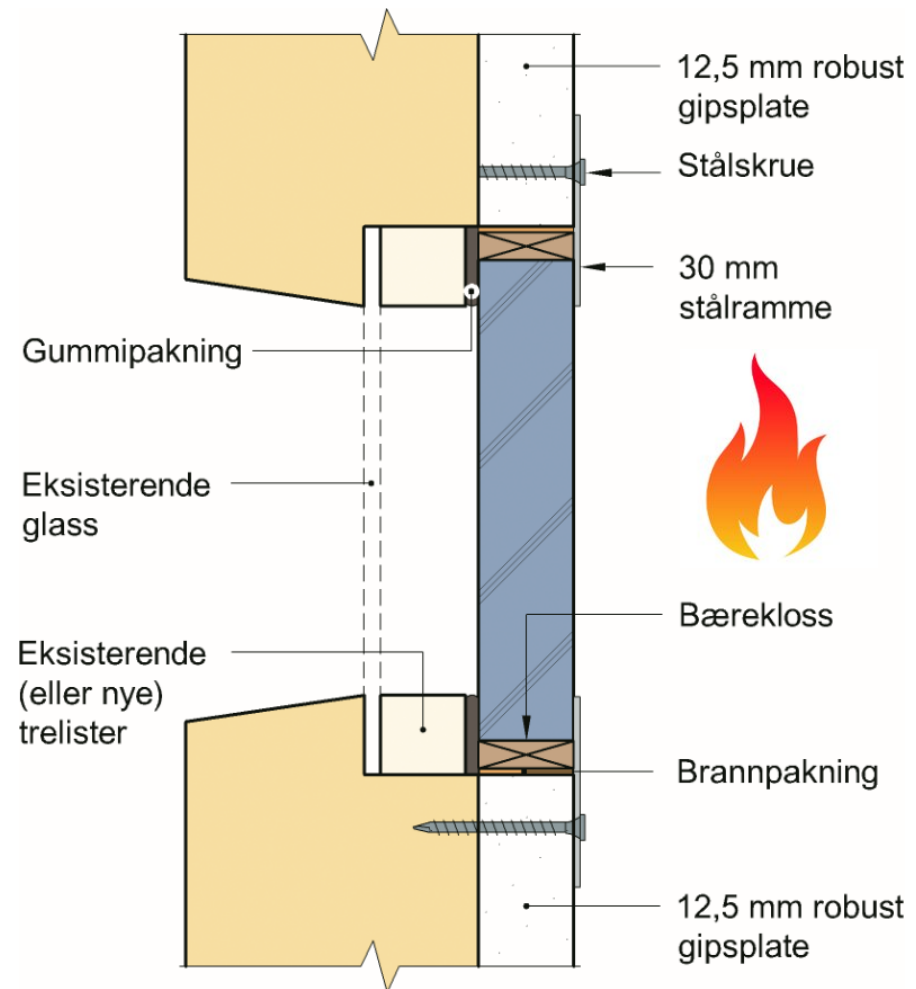

Guideline



Foto: Jømna

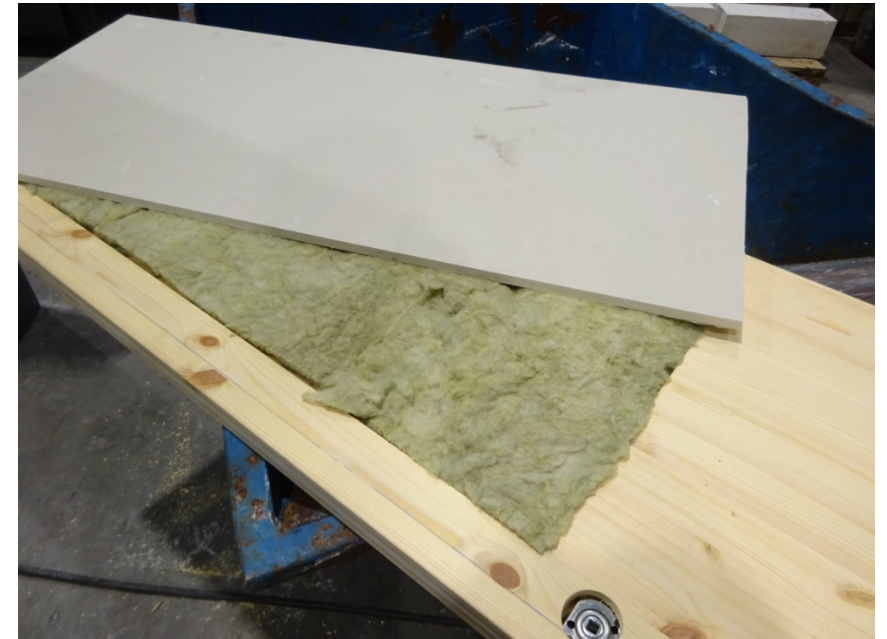
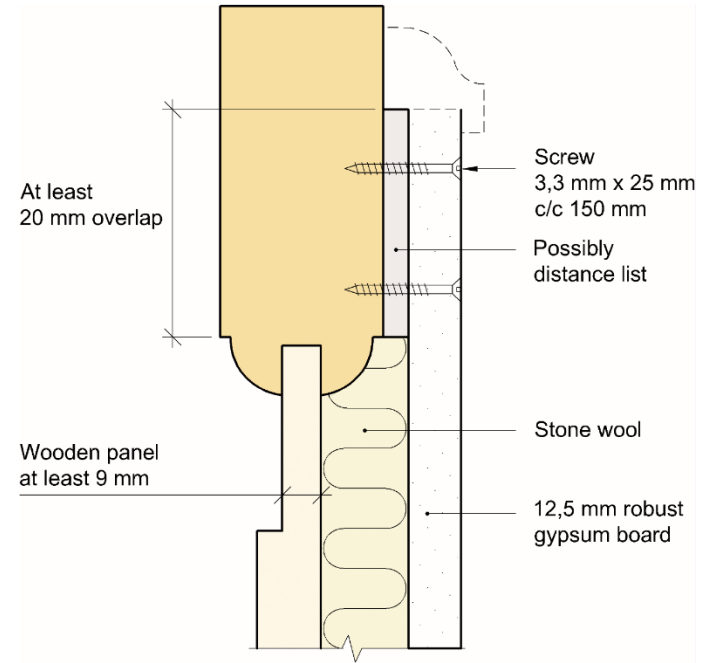

Guideline





Teknologi for et bedre samfunn