

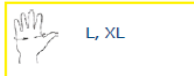



OPP - Outils de protection personnelles

Gants de soudure doublé coton pour MMA et MIG/MAG				9.2	
No° pos.	N° de commande	Description	UNITE	EMB	
	WE102101L	L, XL Lashandschoen ECONOMY	paire	1 /10 /60	
	WE102101L	L, XL Lashandschoen ECONOMY	paire	1 /10 /60	

10-2101









 L, XL	 34 cm.	<ul style="list-style-type: none"> - The 10-2101 is our general purpose glove of the range - Cow shoulder split leather - Full cotton lined 	EN 12477 (09.2005) TYPE A/B TÜV BP 60017622 0003 TÜV 21128415 002 
 90%			

No° pos.	N° de commande	Description	UNITE	EMB	
	WE102750L	L, XL Lashandschoen PREMIUM STEERSOTUFF	paire	1 /10 /40	
	WE102750L	L, XL Lashandschoen PREMIUM STEERSOTUFF	paire	1 /10 /40	

La peau de vache la plus de haute qualité pour l'huile et la résistance aux intempéries, STEERSOtuff®

10-2750







 L, XL, XXL	 36 cm.	<ul style="list-style-type: none"> - A-grade cow grain leather - Backhand COMFOtuff® lined and cuff cotton lined - Back palm reversed grain (suède) - Oil and weather resistant - Excellent quality and comfortable to wear 	 STEERSOtuff® EN 12477 (09.2005) TYPE A/B TÜV BP 60017622 0001 TÜV 21128415 002 
 30%	250°C CONTACT KEVLAR® 4 ply 		

Gants de soudage pour TIG				9.2	
No° pos.	N° de commande	Description	UNITE	EMB	
	WE101003L	M, L TIG Lashandschoen Softouch™ pigskin Large	paire	1 /10 /60	
	WE101003XL	XL TIG Lashandschoen Softouch™ pigskin XL	paire	1 /10 /60	

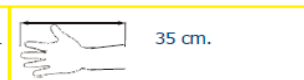
10-1003







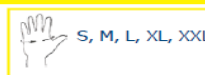

 M, L, XL, XXL	 35 cm.	<ul style="list-style-type: none"> - Oil and abrasion resistant - Reversed (suede) grain pig leather - Seamless index finger 	 SOFTouch™ EN 12477 (09.2005) TYPE A/B TÜV BP 60017622 0003 TÜV 21128415 002 
 KEVLAR® 3 ply 			

	WE101005S	S Gant de soudage TIG Softouch™ Cuir de vachette Small	paire	1 /10 /60	
	WE101005L	M,L Gant de soudage TIG Softouch™ Cuir de vachette Large	paire	1 /10 /60	
	WE101005XL	XL Gant de soudage TIG Softouch™ Cuir de vachette XL	paire	1 /10 /60	

10-1005

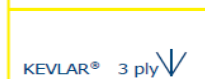

 S, M, L, XL, XXL	 35 cm.	<ul style="list-style-type: none"> - Very smooth and pliable - Calfskin grain leather - Seamless index finger 	 SOFTouch™ EN 12477 (09.2005) TYPE A/B TÜV BP 60017622 0003 TÜV 21128415 002 
 KEVLAR® 3 ply 			

OPP - Outils de protection personnelles

Vêtements de soudage - Cuir Lava Brown				9.2	
No° pos.	N° de commande	Description	UNITE	EMB	
	WE44730086XL	XL Gilet de soudage Cuir Lava Brown™ XL Longueur 86cm	pièce	1 / 5	

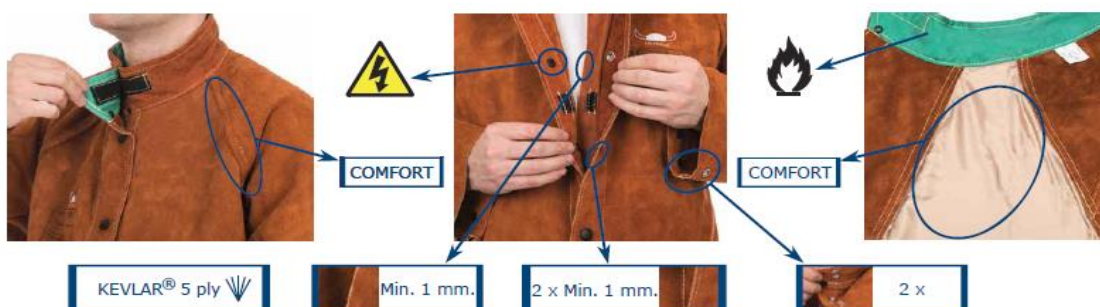

Lava Brown™ products are made of high quality A-grade side split cow leather



44-7300M
44-7300L
44-7300XL
44-7300XXL
44-7300XXXL
44-7300XXXXL

76 cm. 100 cm.
81 cm. 112 cm.
86 cm. 124 cm.
91 cm. 136 cm.
96 cm. 148 cm.
96 cm. 160 cm.

Vêtements - Lava Brown - suite				9.2	
No° pos.	N° de commande	Description	UNITE	EMB	
	WE447142	Tablier de soudage 107 cm longueur Lava Brown™ (60 cm de large)	pièce	1 / 20	

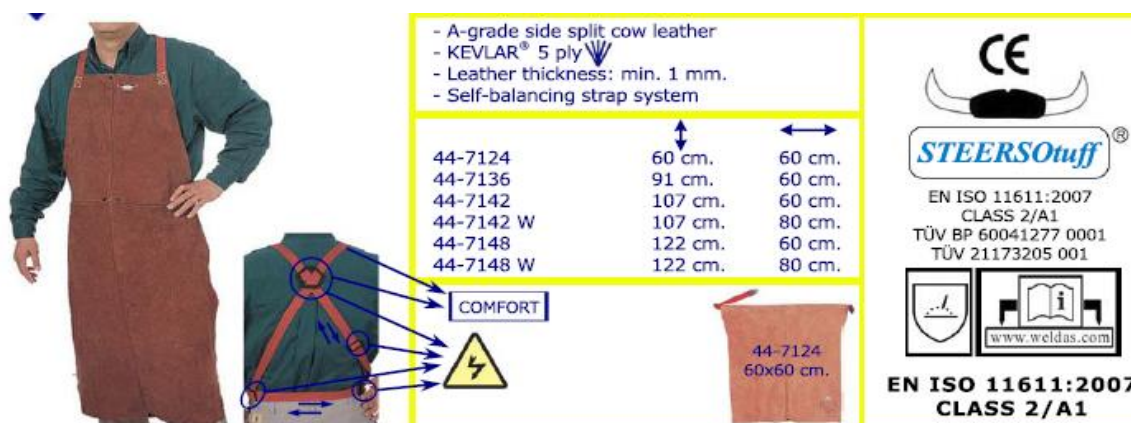

- A-grade side split cow leather
- KEVLAR® 5 ply
- Leather thickness: min. 1 mm.
- Self-balancing strap system

44-7124 60 cm. 60 cm.
44-7136 91 cm. 60 cm.
44-7142 107 cm. 60 cm.
44-7142 W 107 cm. 80 cm.
44-7148 122 cm. 60 cm.
44-7148 W 122 cm. 80 cm.

COMFORT

44-7124
60x60 cm.

CE

STEERSOtuff®

EN ISO 11611:2007
CLASS 2/A1
TÜV BP 60041277 0001
TÜV 21173205 001

www.weldas.com

**EN ISO 11611:2007
CLASS 2/A1**

OPP - Outils de protection personnelles

Helmet Comforters 9.2



SWEATSOpad®

5 x 

20-3100V ↔ 22 cm.
20-3100V/17 ↔ 17 cm.

CE

EN ISO 11611:2003
CLAUSE 6.6
TÜV AK 60013119 0001
TÜV 21120493 001

PERSPIRATION

100% FLEECEY COTTON
OUTER LAYER DRAWS
IN PERSPIRATION

AIR CUSHIONED INNER
LAYER CONTAINS THOUSANDS
OF SMALL CELLS TO HOLD
EXCESSIVE PERSPIRATION

CROSS SECTION
SHOWN ACTUAL SIZE

No° pos.	N° de commande	Description	UNITE	EMB
	WE203100V	Bandeau d'aspiration SWEATSOPAD 22cm (per 2 pièces)	set	1 /10
	WE203100V/17	Bandeau d'aspiration SWEATSOPAD 17cm (per 2 pièces)	set	1 /10

Conseil : WE203100V va bien sur casque de soudure Speedglas 100

Conseil : WE203100V/17 va bien sur casque de soudure Speedglas 9100

Accessoires de soudage 9.2



Heat and flame
resistant canvas

- 50 x 50 x 8 cm.
- KEVLAR® 3 ply

No° pos.	N° de commande	Description	UNITE	EMB
	WE447910	Coussin de soudage 50x50x8cm anti-chaleur et anti-flamme canevas avec poignée	pièce	1 /5

OPP - Outils de protection personnelles

Au cours des activités de soudure, nous devons - comme soudeur - nous protéger de manière adéquate contre les rayonnement UV-A et UV-B, les taches de soudure, jeter des étincelles et la chaleur.

Il existe différents produits. Lastek a fait une sélection éprouvée pour vous.

Lors qu'il s'agit de la sécurité, nous faisons pas de compromis et nous choisissons intégralement la qualité et le confort pour que vous puissiez effectuer bien les activités de soudure pour le prétraitement et le post-traitement.

Si vous avez les souhaits toutefois spécifiques, vous pouvez contacter notre help-desk.

Protection des yeux et du visage

Lunettes de sécurité et de soudage 9.2

No° pos.	N° de commande	Description	UNITE	EMB
----------	----------------	-------------	-------	-----



A	3M2840	Lunettes de protection type 2840 Clear	pièce	1/20
B	3M2845	Lunettes de protection type 2845 5 Adin	pièce	1/10
C	1020000	Lunettes de soudage 220 5 Adin	pièce	1



Lunettes pliables pour une utilisation avec le soudage



D	1020002	Verre blanc, éclats-épreuve pour 220	paire	2 /10
D	1020004	5 Adin Verre pour 220 Diam. 50 mm pour Autogène	paire	2 /10

Lunettes avec masque à souder en cuir - Hors production - voir stock Lastek

No° pos.	N° de commande	Description	UNITE	EMB
	1020100	Lunettes Avec Masque A Souder/Cuir	stuk	1
		HORS PRODUCTION, voir stock Lastek		



OPP - Outils de protection personnelles

Ecrans à main 9.2

No° pos.	N° de commande	Description	UNITE	EMB
B	2040000	Ecran 1202 sans verres 110 X 90	pièce	1
A	2043000	Ecran 1231 sans verres 110 X 90	pièce	1



Casques de soudage avec visière relevable 9.2

No° pos.	N° de commande	Description	UNITE	EMB
C	2045000	Casque 1236 relevable 105 X 50	pièce	1
	2045003	Serre-tête 1212/1236	pièce	1



Visières 9.2



No° pos.	N° de commande	Description	UNITE	EMB
1	2046010	Bandeau bleu 430x250x310mm	pièce	1/10
2	2046001	Ecran facial transparent pour écran de meulage	pièce	1/10
3	2046006	Ecran facial couleur 5 pour écran de meulage	pièce	1/10

OPP - Outils de protection personnelles

Verres blancs 9.2

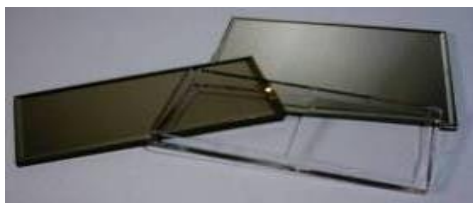

No° pos.	N° de commande	Description	UNITE	EMB
	2069001	Verre blanc 110 X 90	pièce	10 /100
	2069009	Verre blanc 110 X 90 plastique	pièce	10 /100
	2069002	Verre blanc 105 X 50	pièce	10 /100
	2069008	Verre blanc 108 X 51 plastique	pièce	10 /100
	2069007	Verre blanc 100 X 120 plastique	pièce	10 /100

Verres obscures 110 X 90 9.2

	2069100	8 ADIN 110 X 90	pièce	2 /10
	2069150	9 ADIN 110 X 90	pièce	2 /10
	2069200	10 ADIN 110 X 90	pièce	2 /10
	2069250	11 ADIN 110 X 90	pièce	2 /10
	2069301	12 ADIN 110 X 90	pièce	2 /10
	2069351	13 ADIN 110 X 90	pièce	2 /10

Verres obscures 100 X 120 9.2

	2069105	8 ADIN 100 X 120	pièce	2/10
	2069157	9 ADIN 100 X 120	pièce	2/10
	2069202	10 ADIN 100 X 120	pièce	2/10
	2069257	11 ADIN 100 X 120	pièce	2/10
	2069305	12 ADIN 100 X 120	pièce	2/10
		13 ADIN 100 X 120	pièce	2/10

Verres obscures pour 105 X 50 - (108 X 51) 9.2

































































	2069102	8 ADIN 105 X 50	pièce	2/10
	2069154	9 ADIN 105 X 50	pièce	2/10
	2069203	10 ADIN 105 X 50	pièce	2/10
	2069252	11 ADIN 105 X 50	pièce	2/10
	2069303	12 ADIN 105 X 50	pièce	2/10
	2069350	13 ADIN 105 X 50	pièce	2/10
	2069402	14 ADIN 105 X 50	pièce	2/10











Lunettes de lecture - loupe (remplace des lunettes de lecture) 9.2

Loupes pour Speedglas 100 / 9000 / 9002 / 9100 / 9100X / 9100FX				
	2053563	Loupe 1,0 Plastic	pièce	1
	2053560	Loupe 1,5 Plastic	pièce	1
	2053561	Loupe 2,0 Plastic	pièce	1
	2053565	Loupe 2,25 Plastic	pièce	1
	2053562	Loupe 2,5 Plastic	pièce	1
	2053567	Loupe 3,0 Plastic	pièce	1





3M™ Speedglas™ Welding Helmets – sorted by features

	3M™ Speedglas™ Welding Helmet 9100								
	3M™ Speedglas™ Welding Helmet 9100 Air								
	3M™ Speedglas™ Welding Helmet 9100-QR								
	3M™ Speedglas™ Welding Helmet 9100 FX								
	3M™ Speedglas™ Welding Helmet 9100 FX Air								 
	3M™ Speedglas™ Welding Helmet 9100 FX (with safety helmet)								
	3M™ Speedglas™ Welding Helmet 9100 MP								 
	3M™ Speedglas™ Welding Helmet SL								
	3M™ Speedglas™ Welding Helmet 100								
	3M™ Speedglas™ Welding Helmet 100-QR								

 Premium eye protection	 Side windows	 Hearing protection**	 Exhaust vents	 Respiratory system
 Passive option	 Head protection	 Auto-on	 Flip-up	 Graphics option

* Only in combination with 3M™ Speedglas™ Welding Filter 9100000 ** 3M™ Peltor™ Hearing Protection available as accessories, see each welding helmet parts list.

Overzicht Speedglas Casque de soudageen 9.2

3M Speedglas Lashelmen										
Lasfilter	9100V	9100X	9100XX	9100XXi	100S-10	100S-11	100V			
	9100	9100FX	9100-QR	9100 Air	9100FX Air	9100MP Air	100	100QR	100V	zwart/graphic
Lashelm Serie	9100	9100FX	9100-QR	9100 Air	9100FX Air	9100MP Air	100	100QR	100V	zwart/graphic
Luchttoevoer	neen		ja		neen		neen			
Versaflo	neen		ja		neen		neen			
Beschermruit binnen standaard	9100V	9100X	9100XX	9100XXi	100S-10	100S-11	100V			
FX anti-damp binnenruit	528005	528015	528025	528025	428000					
Beschermruit buiten standaard	523001	nvt	nvt	523001	776000					
buiten krasbestendig	526000		527000		777000					
buiten extra krasbestendig	527001		527001		777070					
buiten hittebestendig	527070		527070		422000					
Batterij set	422000		422000		422000					
Zweetband	168015	nvt	168015	168015	167520					

3M™ Speedglas™ Welding Helmet Series 100



75 25 20

Part No	Description	Part No	Description	Part No	Description
75 11 01	Speedglas welding helmet 100 Black, including passive filter shade 11.	75 17 20	Speedglas welding helmet 100 Aces High with 100V filter.	75 24 20	Speedglas welding helmet 100 Razor Dragon with 100V filter.
75 11 10	Speedglas welding helmet 100 Black with 100S-10 filter.	75 18 20	Speedglas welding helmet 100 Steel Rose with 100V filter.	75 25 20	Speedglas welding helmet 100 Ice Hot with 100V filter.
75 11 11	Speedglas welding helmet 100 Black with 100S-11 filter.	75 19 20	Speedglas welding helmet 100 Skull Jewels with 100V filter.	75 26 20	Speedglas welding helmet 100 Raging Skull with 100V filter.
75 11 20	Speedglas welding helmet 100 Black with 100V filter.	75 20 20	Speedglas welding helmet 100 Wild 'n' Pink with 100V filter.	75 27 20	Speedglas welding helmet 100 Future Combatant with 100V filter.
75 12 20	Speedglas welding helmet 100 Blaze, with 100V filter.	75 21 20	Speedglas welding helmet 100 Steel Eyes with 100V filter.		
75 16 20	Speedglas welding helmet 100 Trojan Warrior with 100V filter.	75 22 20	Speedglas welding helmet 100 Xterminator with 100V filter.		

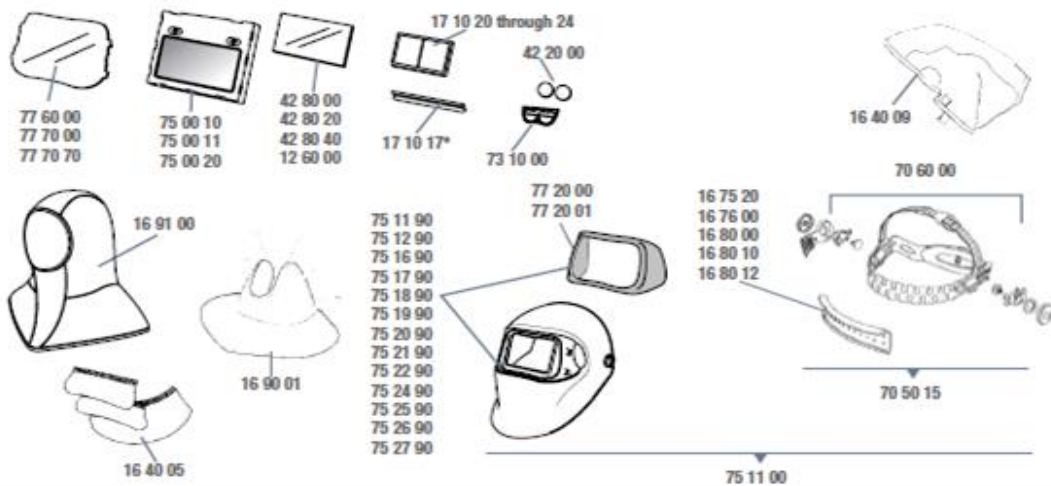

Accessories and spare parts

Part No	Description	Part No	Description	Part No	Description
12 60 00	Inner cover plate (90x110 mm) for 100 passive filter.	70 60 00	Assembly parts for headband.	75 19 90	100 welding helmet Skull Jewels, without welding filter, without headband.
16 40 05	Ear and neck protection in leather.	73 10 00	Battery cover.	75 20 90	100 welding helmet Wild 'n' Pink, without welding filter, without headband.
16 40 09	Head protection, black/grey.	75 00 10	Speedglas welding filter 100S-10, single shade 10.	75 21 90	100 welding helmet Steel Eyes, without welding filter, without headband.
16 75 20	Sweatband, toweling purple, pkg of 2.	75 00 11	Speedglas welding filter 100S-11, single shade 11.	75 22 90	100 welding helmet Xterminator, without welding filter, without headband.
16 76 00	Sweatband, toweling purple, pkg of 20.	75 00 20	Speedglas welding filter 100V, variable shade 8-12.	75 24 90	100 welding helmet Razor Dragon, without welding filter, without headband.
16 80 00	Sweatband, leather.	75 05 11	Speedglas 100 passive kit: 110x90 mm passive welding filter shade 11, inner cover plate, outer protection plate and filter frame (not shown).	75 25 90	100 welding helmet Ice Hot, without welding filter, without headband.
16 80 10	Sweatband, fleecy cotton, pkg of 2.	75 11 00	100 welding helmet black, without welding filter with headband.	75 26 90	100 welding helmet Raging Skull, without welding filter, without headband.
16 80 12	Sweatband, fleecy cotton (short), pkg of 2.	75 11 90	100 welding helmet black, without welding filter, without headband.	75 27 90	100 welding helmet Future Combatant, without welding filter, without headband.
16 90 01	Neck protection, black/grey.	75 12 90	100 welding helmet Blaze, without welding filter, without headband.	77 20 00	Front frame, silver.
16 91 00	Hood black/grey.	75 16 90	100 welding helmet Trojan Warrior, without welding filter, without headband.	77 20 01	Front frame, black.
17 10 17	Holder for magnifier.	75 17 90	100 welding helmet Aces High, without welding filter, without headband.	77 60 00	Outer protection plate, standard, pkg of 10.
17 10 20	Magnifying lens 1.0.	75 18 90	100 welding helmet Steel Rose, without welding filter, without headband.	77 70 00	Outer protection plate, scratch resistant, pkg of 10.
17 10 21	Magnifying lens 1.5.			77 70 70	Outer protection plate, heat resistant, pkg of 10.
17 10 22	Magnifying lens 2.0.				
17 10 23	Magnifying lens 2.5.				
17 10 24	Magnifying lens 3.0.				
42 20 00	Battery, pkg of 2.				
42 80 00	Inner cover plate, pkg of 5. Plate marking 42 02 00.				
42 80 20	Inner cover plate, +1 shade, pkg of 5.				
42 80 40	Inner cover plate, +2 shade, pkg of 5.				
70 50 15	New headband (Sept 2012) with assembly parts.				

* Needed for older models

OPP - Outils de protection personnelles

Speedglas 100 Casque de soudage

9.2



No° pos.	N° de commande	Description	UNITE	EMB
Speedglas 100 Casque de soudage exécution noire				
1	3MH751110	Speedglas 100S Casque avec filtre Adf 10Adin	pièce	1
1	3MH751120	Speedglas 100V Casque avec filtre Adf 8-12Adin	pièce	1
Speedglas 100 Graphic Casque de soudage				
2	3MH751220	Speedglas 100 Casque avec filtre 8-12Adin BLAZE	pièce	1
3	3MH751620	Speedglas 100 Casque avec filtre 8-12Adin TROJAN	pièce	1
4	3MH751820	Speedglas 100 avec filtre 8-12 Adin STEEL ROSE	pièce	1
5	3MH751920	Speedglas 100 avec filtre 8-12 Adin SKULL JEWELS	pièce	1
6	3MH752020	Speedglas 100 avec filtre 8-12 Adin WILD'N PINK	pièce	1
7	3MH752120	Speedglas 100 avec filtre 8-12 Adin STEEL EYES	pièce	1
8	3MH751720	Speedglas 100 Casque avec cassette 8-12 ACES HIGH	pièce	1
9	3MH752220	Speedglas 100 avec filtre 8-12 Adin XTERMINATOR	pièce	1
10	3MH752720	Speedglas 100 avec filtre 8-12 Adin Combat	pièce	1
11	3MH752420	Speedglas 100 avec filtre 8-12 Adin RAZOR DRAGON	pièce	1
12	3MH752520	Speedglas 100 avec filtre 8-12 Adin ICE HOT	pièce	1
13	3MH752620	Speedglas 100 avec filtre 8-12 Adin RAGING SKULL	pièce	1
Speedglas 100 Cassette				
	3MH750010	Cassette 10 Adin Speedglas 100	pièce	1
	3MH750020	Cassette 8-12 Adin Speedglas 100	pièce	1
Speedglas 100/100V/9002V/9002D/9000V Ecrans de protection				
	3MH776000	Ecran de protection externe (sachet de 10 pcs)	set	1
	3MH777000	Ecran de protection externe super résistant aux rayures (sachet de 10 pcs)	set	1
	3MH777070	Ecran de protection externe - résistant au chaleur. (sachet de 10 pcs)	set	1
	2053456	428000 Ecran de protection interne (set de 5 pcs)	set	1
	2053449	428020 Ecran de protection interne extra couleur DIN1 (set de 5 pcs)	set	1
	2053488	428040 Ecran de Protection interne extra couleur DIN2 (set de 5 pcs)	set	1
Speedglas 100 Accessoires				
	2053453	422000 Batterie Speedglas 9000 (set de 2 pcs)	set	1
	3MH705015	Serre-tête avec set de fixation	pièce	1
	2053462	167520 Bandeau d'aspiration en tissu-éponge + velcro	set	1
	WE203100V	Bandeau d'aspiration SWEATSOPAD 22cm (per 2 pièces)	set	1/10
	3MH171017	Support-loupe pour Speedglas	pièce	1

OPP - Outils de protection personnelles

Speedglas 100-QR Casque de soudage + Casque de sécurité

9.2

3M™ Speedglas™ Welding Helmet 100-QR

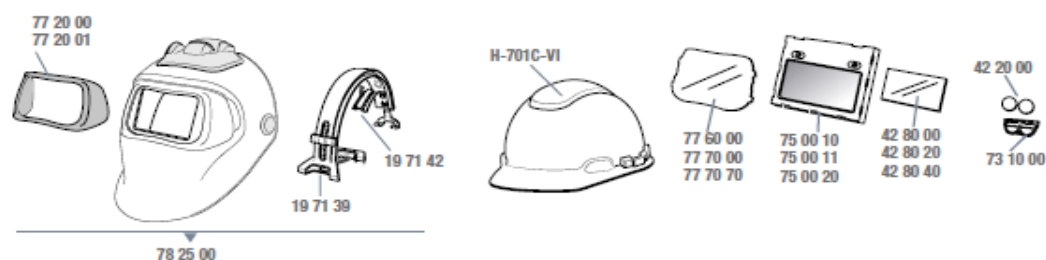

Part No	Description	Part No	Description	Part No	Description
16 40 05	Ear and neck protection in leather.	75 00 10	Speedglas welding filter 100S-10, single shade 10.	77 70 70	Outer protection plate, heat resistant, pkg of 10.
19 71 39	Quick release rail for safety helmet.	75 00 11	Speedglas welding filter 100S-11, single shade 11.	78 15 00	Welding helmet 100-QR without quick release rail, without welding filter, without safety helmet.
19 71 42	Rubber friction pads for quick release rail.	75 00 20	Speedglas welding filter 100V, variable shade 8-12.	78 25 00	Welding helmet 100-QR with quick release rail, without welding filter, without safety helmet.
19 71 43	Pivot cover plate kit for quick release welding helmets (QR), pkg of 2.	77 20 00	Front frame, silver.	78 25 20	3M™ Speedglas™ Welding Helmet 100-QR with 3M™ Speedglas™ 100V
42 20 00	Battery, pkg of 2	77 20 01	Front frame, black.	H-701C-VI	3M™ Safety Helmet H-701R (unvented)
42 80 00	Inner cover plate, pkg of 5.	77 60 00	Outer protection plate, standard, pkg of 10.		
42 80 20	Inner cover plate, +1 shade, pkg of 5.	77 70 00	Outer protection plate, scratch resistant, pkg of 10.		
42 80 40	Inner cover plate, +2 shade, pkg of 5.				
73 10 00	Battery cover for welding filter series 100.				

No° pos.	N° de commande	Description	UNITE	EMB
		Speedglas 100-QR Casque de soudage pour monter sur casque de sécurité		
	3MH782500	Casque de soudure 100-QR avec rail quick-Release, sans filtre de soudure et sans casque	pièce	1
	3MH701CVI	Casque de sécurité H-701T (pas ventilé) - pin lock	pièce	20
		Speedglas 100-9100-QR Accessoires		
	2053564 169100	Cagoule Teca Weld	pièce	1
	3MH197139	Quick Release rail pour casque de sécurité	pièce	1
	3MH197142	Fixation en caoutchouc pour QR-rail	pièce	1
		Speedglas 100 Cassette		
	3MH750010	Cassette 10 Adin Speedglas 100	pièce	1
	3MH750011	Cassette 11 Adin Speedglas 100	pièce	1
	3MH750020	Cassette 8-12 Adin Speedglas 100	pièce	1
		Speedglas 100/100V/9002V/9002D/9000V Ecrans de protection		
	3MH776000	Ecran de protection externe (sachet de 10 pcs)	set	1
	3MH777000	Ecran de protection externe super résistant aux rayures (sachet de 10 pcs)	set	1
	3MH777070	Ecran de protection externe super résist. au chaleur (sachet de 10 pcs)	set	1
	2053456 428000	Ecran de protection interne (set de 5 pcs)	set	1
	2053449 428020	Ecran de protection interne extra couleur DIN1 (set de 5 pcs)	set	1
	2053488 428040	Ecran de Protection interne extra couleur DIN2 (set de 5 pcs)	set	1
		Speedglas 100 Accessoires		
	2053453 422000	Batterie Speedglas 9000 (set de 2 pcs)	set	1
	3MH171017	Support-loupe pour Speedglas	pièce	1

3M™ Speedglas™ Welding Helmet 9100



50 18 26

Part No	Description	Part No	Description	Part No	Description
50 11 05	Speedglas welding helmet 9100 without SideWindows, with filter 9100V	50 18 05	Speedglas welding helmet 9100 with SideWindows and filter 9100V	50 18 26	Speedglas welding helmet 9100 with SideWindows and welding filter kit 9100XX (incl filter and silver front 9100XX).
50 11 15	Speedglas welding helmet 9100 without SideWindows, with filter 9100X	50 18 15	Speedglas welding helmet 9100 with SideWindows and filter 9100X		
50 11 25	Speedglas welding helmet 9100 without SideWindows, with filter 9100XX	50 18 25	Speedglas welding helmet 9100 with SideWindows and filter 9100XX		

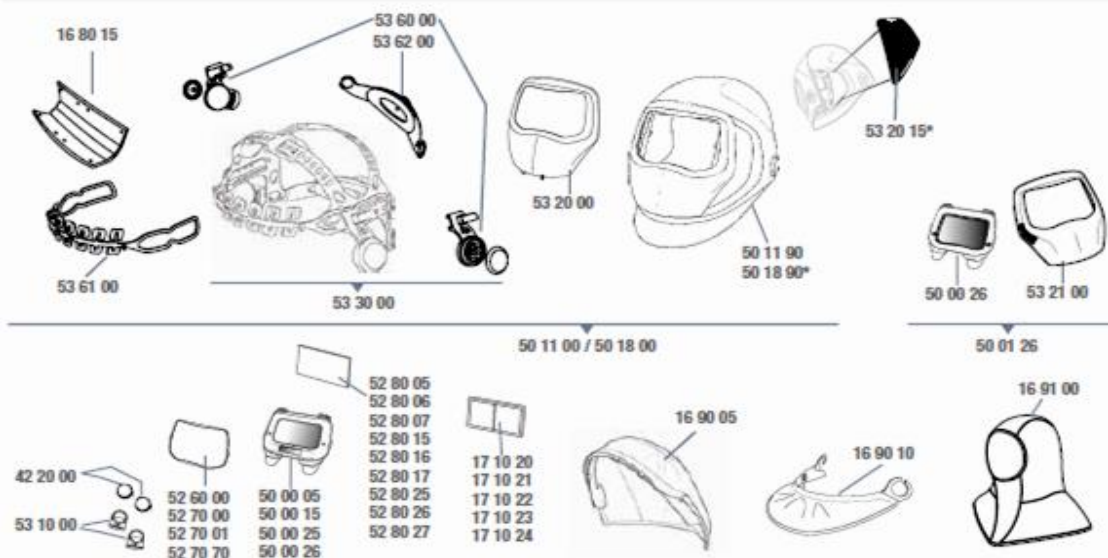

Accessories and spare parts

Part No	Description	Part No	Description	Part No	Description
16 80 15	Comfort sweatband, pkg of 3.	50 11 90	Welding helmet without SideWindows, without headband, with silver front.	52 80 16	Inner cover plate, +1 shade for 9100X filter, pkg of 3.
16 90 05	Head protection, black.	50 18 00	Welding helmet with SideWindows and headband, with silver front.	52 80 17	Inner cover plate, +2 shade for 9100X filter, pkg of 3.
16 90 10	Neck protection, black.	50 18 90*	Welding helmet with SideWindows, without headband.	52 80 25	Inner cover plates for 9100XX filter, pkg of 5. Plate marking 117x77.
16 91 00	Hood, black/grey.	52 60 00	Outer protection plate standard, pkg of 10.	52 80 26	Inner cover plate, +1 shade for 9100XX filter, pkg of 3.
17 10 20	Magnifying lens 1.0.	52 70 00	Outer protection plate scratch resistant, pkg of 10.	52 80 27	Inner cover plates, +2 shade for 9100XX filter, pkg of 3.
17 10 21	Magnifying lens 1.5.	52 70 01	Outer protection plate extra scratch resistant, pkg of 10.	53 10 00	Battery holder, pkg of 2.
17 10 22	Magnifying lens 2.0.	52 70 70	Outer protection plate heat resistant, pkg of 10.	53 20 00	Heat-reflecting silver front.
17 10 23	Magnifying lens 2.5.	52 80 05	Inner cover plate for 9100V filter, pkg of 5. Plate marking 117x50.	53 20 15*	SideWindows cover plates, 2 pairs.
17 10 24	Magnifying lens 3.0.	52 80 06	Inner cover plate, +1 shade for 9100V filters, pkg of 3.	53 21 00	Heat-reflecting silver front for welding filter kit 9100XX.
42 20 00	Battery, pkg of 2.	52 80 07	Inner cover plate, +2 shade for 9100V filters, pkg of 3.	53 30 00	Speedglas 9100 headband with assembly parts.
50 00 05	Speedglas welding filter 9100V, variable shade 5, 8, 9-13.	52 80 15	Inner cover plate for 9100X filter, pkg of 5. Plate marking 117x61.	53 60 00	Pivot mechanism, left and right.
50 00 15	Speedglas welding filter 9100X, variable shade 5, 8, 9-13.			53 61 00	Headband front part.
50 00 25	Speedglas welding filter 9100XX, variable shade 5, 8, 9-13.			53 62 00	Headband back part.
50 00 26	Speedglas welding filter 9100XX, variable shade 5, 8, 9-13.				
50 01 26	Speedglas welding filter kit 9100XX (incl new silver front and welding filter)				
50 11 00	Welding helmet without SideWindows, with headband.				

* Please use Part No 50 18 90 when new SideWindows are required.

OPP - Outils de protection personnelles

Speedglas 9100 Casque de soudage			9.2	
No° pos.	N° de commande	Description	UNITE	EMB
		Speedglas 9100 Casque de soudage		
		3MH501805 Speedglas 9100 V 3/5/8/9-13 Sidewindows	pièce	1
		3MH501815 Speedglas 9100 X 3/5/8/9-13 Sidewindows	pièce	1
		3MH501825 Speedglas 9100 XX 3/5/8/9-13 Sidewindows	pièce	1
		3MH501826 Speedglas 9100 XXi 3/5/8/9-13 Sidewindows	pièce	1
		Speedglas Cassette		
	3MH500005	Cassette Speedglas 9100 V 3/5/8/9-13	pièce	1
	3MH500015	Cassette Speedglas 9100 X 3/5/8/9-13	pièce	1
	3MH500025	Cassette Speedglas 9100 XX 3/5/8/9-13	pièce	1
	3MH500026	Cassette Speedglas 9100 XXi 3/5/8/9-13	pièce	1
	3MH500126	Cassette Speedglas 9100 XXi 3/5/8/9-13 + front anti-chaleur	pièce	1
	3MH532100	Front anti-chaleur pour commande Xxi cassette	pièce	1
		Speedglas 9100 Ecrans de protection		
	3MH526000	Ecran de protection externe standard (set de 10pcs)	set	1
	3MH527001	Ecran de protection externe 9100 résistant au rayures (set de 10 pcs)	set	1
	3MH527070	Ecran de protection externe - résistant au chaleur (set de 10 pcs)	set	1
	3MH528005	Ecran de protection interne 9100 V (set de 5 pcs)	set	1
	3MH528015	Ecran de protection interne 9100 X (set de 5 pcs)	set	1
	3MH528025	Ecran de protection interne 9100 XX (set de 5 pcs)	set	1
		Speedglas 9100 Accessoires		
	3MH168015	Bandeau d'aspiration absorbant en coton (set de 3 Pcs)	set	1
	WE203100V/17	Bandeau d'aspiration SWEATSOPAD 17cm (set de 2 pcs)	set	1 /10
	3MH532000	Face avant en argent qui réfléchisse la chaleur	pièce	1
	3MH533000	Serre tête avec fixation speedglas 9100	pièce	1
	2053564	169100 Cagoule Teca Weld	pièce	1
	3MH169005	Protection teca weld	pièce	1
	3MH169010	Protection cou en oreilles Speedglas 9100	pièce	1

3M™ Speedglas™ Welding Helmets 9000 / FlexView / ProTop / Utility

Accessories and spare parts**

Part No	Description	Part No	Description	Part No	Description
16 40 05	Ear and neck protection in leather.	40 18 90*	Speedglas welding helmet 9000 with SideWindows, without headband, without filter.	42 80 50	Inner cover plate, +2 Shade for 9002X/9000XF filters, pkg of 5.
16 40 09	Head protection, black/grey.	42 20 00	Battery, pkg of 2.	43 10 00	Battery cover, pkg of 2.
16 75 20	Sweatband towelling, pkg of 2.	42 30 00	Protective visor plate FlexView, pkg of 10.	43 20 00	Heat-reflecting front, silver.
16 75 50	Sweatband ProTop, pkg of 2.	42 60 00	Outer protection plate, standard, pkg of 10. Plate marking 42 01 50.	43 20 15*	SideWindows cover plate (sticker), 5 pairs.
16 76 00	Sweatband towelling, pkg of 20.	42 70 00	Outer protection plate, scratch resistant, pkg of 10. Plate marking 42 01 00.	44 05 00	Speedglas FlexView Conversion Kit.
16 80 00	Sweatband, leather.	42 70 71	Outer protection plate, heat resistant, pkg of 10. Plate marking 42 01 71 HEAT.	44 10 00	Middle helmet FlexView, black.
16 80 10	Sweatband, fleecy cotton, pkg of 2.	42 80 00	Inner cover plate (42x91 mm) for 9002D/9002V filters, pkg of 5. Plate marking 42 02 00.	44 20 00	Heatreflecting front FlexView, silver.
16 80 12	Sweatband, fleecy cotton (short), pkg of 2.	42 80 10	Inner cover plate (53x103 mm) for 9002X/9000XF filters, pkg of 5. Plate marking 42 02 10.	48 28 00	Speedglas welding helmet ProTop, with SideWindows, without safety helmet, without welding filter.
16 90 01	Neck protection, black/grey.	42 80 20	Inner cover plate, +1 Shade for 9002D/9002V filters, pkg of 5.	70 50 15	New headband (Sept 2012) with assembly parts.
16 91 00	Hood black/grey.	42 80 30	Inner cover plate, +1 Shade for 9002X/9000XF filters, pkg of 5.	70 60 00	Assembly parts for headband.
17 10 15	Holder for magnifying lens (not shown)	42 80 40	Inner cover plate, +2 Shade for 9002D/9002V filters, pkg of 5.		
17 10 20	Magnifying lens 1.0.				
17 10 21	Magnifying lens 1.5.				
17 10 22	Magnifying lens 2.0.				
17 10 23	Magnifying lens 2.5.				
17 10 24	Magnifying lens 3.0.				
19 71 30	Safety helmet assembly parts ProTop.				
19 71 31	Welding helmet mechanism parts ProTop.				
19 71 40	Holder for welding filter (FlexView).				
19 71 41	Locking wedge kit, holder welding filter (FlexView).				
40 11 90	Speedglas welding helmet 9000, without SideWindows, without headband, without filter.				

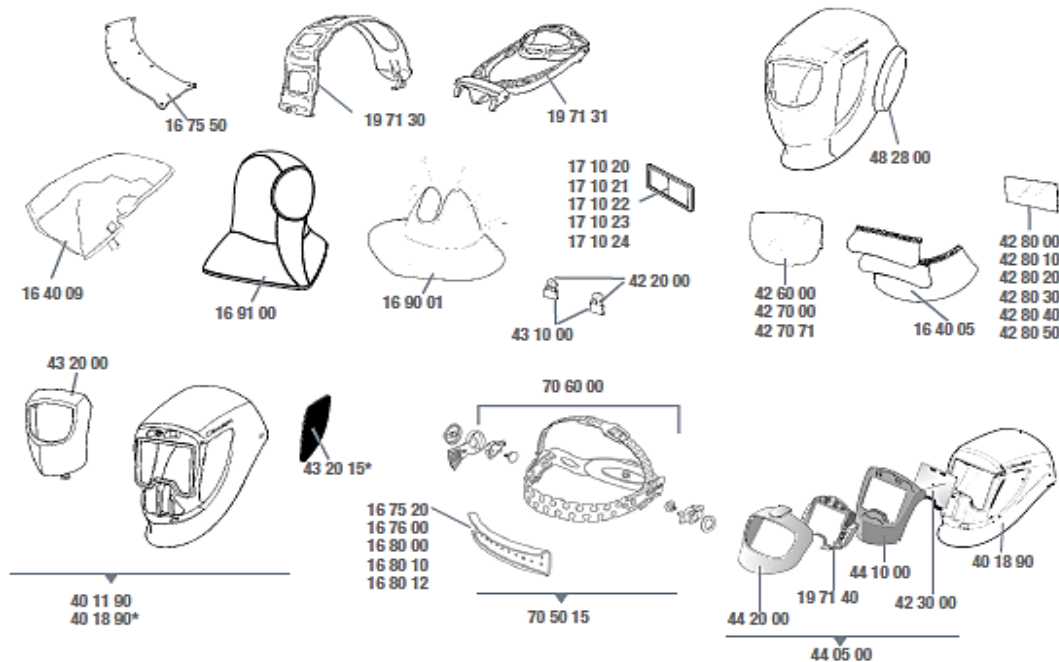

* Please use Part No 40 18 90 when new SideWindows are required.

** Speedglas welding helmets 9100, 9100 Air, 9100 FX and 9100 FX Air replace the welding helmets 9000 and 9000 FlexView.

OPP - Outils de protection personnelles

Casque de soudage 9000/FlexView/ProTop/Utility fin de la gamme				9.2	
No° pos.	N° de commande	Description	UNITE	EMB	
Speedglas 9000 Ecrans de protection					
	2053456 428000	Ecran de protection interne (set de 5 pcs)	set	1	
	2053449 428020	Ecran de protection interne extra couleur DIN1 (set de 5 pcs)	set	1	
	2053457 428010	Ecran de protection interne 9000X/9002 XF 103x53 (set de 5 pcs)	set	1	
	2053488 428040	Ecran de Protection interne extra couleur DIN2 (set de 5 pcs)	set	1	
	2053487 428030	Ecran de protection interne 9000 X/XF couleur 1 (set de 5 pcs)	set	1	
	2053475 428050	Ecran de protection interne 2 adin (set de 5 pcs)	set	1	
	2053454 426000	Ecran de protection externe (set de 10 pcs) 0196HE 1F din 420150	set	1	
	2053455 427000	Ecran de protection externe éclats-éprouves (set de 10 pcs)	set	1	
	2053470 427071	Ecran de protection externe résistant à la chaleur (set de 10 pcs)	set	1	
Speedglas 9000 Loupes 100 / 9000 / 9002 / 9100 / 9100X / 9100FX					
	2053560 171021	Loupe 1.5 Plastic	pièce	1	
	2053561 171022	Loupe 2.0 Plastic	pièce	1	
	2053562 171023	Loupe 2.5 Plastic	pièce	1	
Speedglas 9000 Accessoires					
	2053056 164009	Protection de la tête Teca Weld	pièce	1	
	WE203100V/17	Bandeau SWEATSOPAD 17cm (set de 2 pièces)	paire	1	
	2053509 168000	Bandeau d'aspiration cuir Apc/100/9000	pièce	1	
	3MH705015	Serre-tête avec set de fixation	pièce	1	
	2053452 401895	Casque avec Sidewindows interne	pièce	1	
	2053459 432000	Face avant en argent qui réfléchisse la chaleur	pièce	1	
	2053904 440500	Kit de conversion FlexView + 1 écran de protection	pièce	1	
	2053906 423000	Ecran de protection (set de 10pcs)	pièce	1	
	2053907 441000	Flewview front interne noir	pièce	1	
	2053905 197140	Porte-cassette Flexview	pièce	1	
	2053908 442000	Flewview front resistant a la chaleur, argent	pièce	1	
	2053458 431000	Cache Batteries (set de 2 pcs)	set	1	
	2053551 164005	Protection oreilles et cou, 3-pièces Apc/XI, cuir	pièce	1	
	2053057 169001	Protection gorge Teca Weld	pièce	1	
	2053453 422000	Batterie Speedglas 9000 (set de 2 pcs)	pièce	1	

3M™ Speedglas™ Welding Helmet 9100 FX



54 18 25

Part No	Description	Part No	Description	Part No	Description
54 18 05	Speedglas welding helmet 9100 FX with SideWindows and filter 9100V.	54 18 15	Speedglas welding helmet 9100 FX with SideWindows and filter 9100X.	54 18 25	Speedglas welding helmet 9100 FX with SideWindows and filter 9100XX.

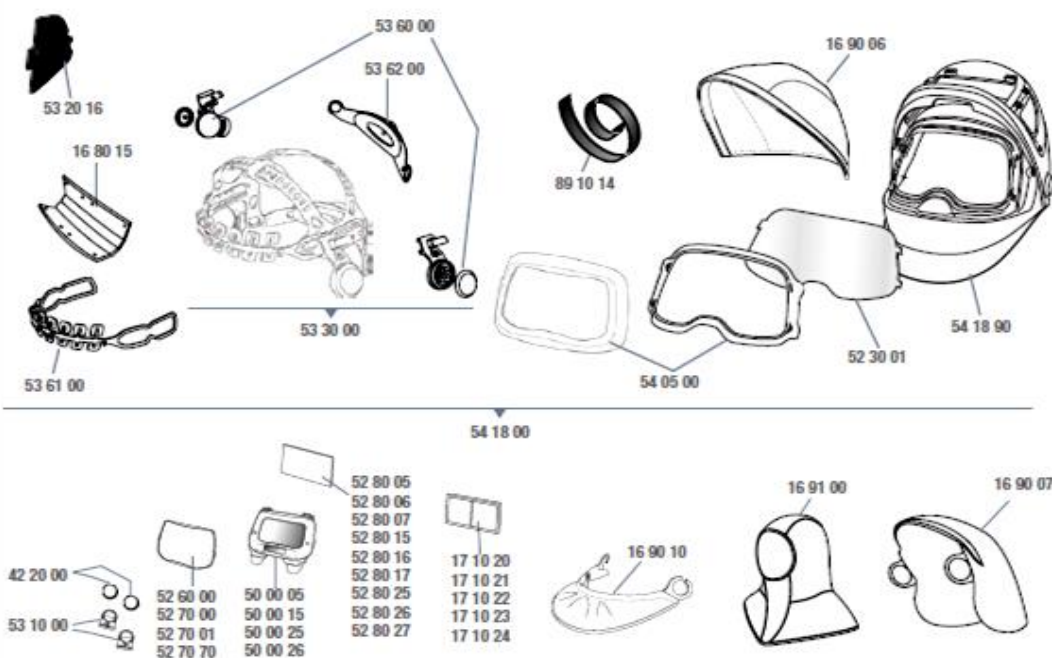

Accessories and spare parts

Part No	Description	Part No	Description	Part No	Description
16 80 15	Comfort sweatband, pkg of 3.	52 70 01	Outer protection plate extra scratch resistant, pkg of 10.	52 80 27	Inner cover plate, +2 shade for 9100XX filter, pkg of 3.
16 90 06	Head protection (small).	52 70 70	Outer protection plate, heat resistant pkg of 10.	53 10 00	Battery holder, pkg of 2.
16 90 07	Head protection (large).	52 80 05	Inner cover plate for 9100V filter, pkg of 5. Plate marking 117x50.	53 20 16	SideWindows cover plate, 2 pairs.
16 90 10	Neck protection, black.	52 80 06	Inner cover plate, +1 shade for 9100V filters, pkg of 3.	53 30 00	Speedglas headband 9100, with assembly parts.
16 91 00	Hood, black/grey.	52 80 07	Inner cover plate, +2 shade for 9100V filters, pkg of 3.	53 60 00	Pivot mechanism, left and right.
17 10 20	Magnifying lens 1.0.	52 80 15	Inner cover plate for 9100X filter, pkg of 5. Plate marking 117x61.	53 61 00	Headband front part.
17 10 21	Magnifying lens 1.5.	52 80 16	Inner cover plate, +1 shade for 9100X filter, pkg of 3.	53 62 00	Headband back part.
17 10 22	Magnifying lens 2.0.	52 80 17	Inner cover plate, +2 shade for 9100X filter, pkg of 3.	54 05 00	Front cover kit.
17 10 23	Magnifying lens 2.5.	52 80 25	Inner cover plate for 9100XX filter, pkg of 5. Plate marking 117x77.	54 18 00	Welding helmet, without welding filter, with headband.
17 10 24	Magnifying lens 3.0.	52 80 26	Inner cover plate, +1 shade for 9100XX filter, pkg of 3.	54 18 90	Welding helmet, without welding filter, without headband.
42 20 00	Battery, pkg of 2.	52 80 27	Inner cover plate, +2 shade for 9100XX filter, pkg of 3.	89 10 14	Velcro for Headcover, pkg of 2.
50 00 05	Speedglas welding filter 9100V.				
50 00 15	Speedglas welding filter 9100X.				
50 00 25	Speedglas welding filter 9100XX.				
50 00 26	Speedglas welding filter 9100XXG.				
52 30 01	Visor plate anti-fog, pkg of 5.				
52 60 00	Outer protection plate, standard, pkg of 10.				
52 70 00	Outer protection plate scratch resistant, pkg of 10.				

OPP - Outils de protection personnelles

Speedglas 9100 FX casque de soudage + visière de meulage				9.2	
No° pos.	N° de commande	Description	UNITE	EMB	
Speedglas 9100FX casque					
2	3MH541805	Speedglas 9100 Fx avec cassette 9100V	pièce	1	
2	3MH541815	Speedglas 9100 Fx avec cassette 9100X	pièce	1	
2	3MH541825	Speedglas 9100 Fx avec cassette 9100XX	pièce	1	
2	3MH541826	Speedglas 9100 Fx avec cassette 9100XXi	pièce	1	
Speedglas Cassette					
	3MH500005	Cassette Speedglas 9100 V 3/5/8/9-13	pièce	1	
	3MH500015	Cassette Speedglas 9100 X 3/5/8/9-13	pièce	1	
	3MH500025	Cassette Speedglas 9100 XX 3/5/8/9-13	pièce	1	
	3MH500026	Cassette Speedglas 9100 XXi 3/5/8/9-13	pièce	1	
Speedglas 9100 Ecrans de protection					
	3MH526000	Ecran de protection externe 9100 (set de 10 pcs)	set	1	
	3MH527001	Ecran de protection ext. 9100 résistant au rayures (set de 10 pcs)	set	1	
	3MH527070	Ecran de protection externe - résistant au chaleur (set de 10 pcs)	set	1	
	3MH528005	Ecran de protection interne 9100 V (set de 5 pcs)	set	1	
	3MH528015	Ecran de protection interne 9100 X (set de 5 pcs)	set	1	
	3MH528025	Ecran de protection interne 9100 XX (set de 5 pcs)	set	1	
Speedglas 9100FX Ecran de protection					
	3MH523001	Ecran de protection 9100 Fx anti-buée (set de 5pcs)	set	1	
Speedglas 9100 Accessoires					
	3MH168015	Bandeau d'aspiration speedglas 9100 (set de 3 pcs)	set	1	
	WE203100V/17	Bandeau d'aspiration SWEATSOPAD 17cm (set de 2 pièces)	set	1 / 10	
	3MH533000	Serre tête avec fixation speedglas 9100	pièce	1	
	2053564	169100 Cagoule Teca Weld	pièce	1	
	3MH169010	Protection cou en oreilles Speedglas 9100	pièce	1	



Speedglas 9100-QR Casque de soudage + Casque de sécurité

9.2

3M™ Speedglas™ Welding Helmet 9100-QR

58 26 25



Part No	Description	Part No	Description	Part No	Description
58 26 05	3M™ Speedglas™ Welding Helmet 9100-QR with 3M™ Speedglas™ Welding Filter 9100V.	58 26 25	3M™ Speedglas™ Welding Helmet 9100-QR with 3M™ Speedglas™ Welding Filter 9100XX.	58 36 15	Speedglas welding helmet 9100-QR with 9100X welding filter.
58 26 15	3M™ Speedglas™ Welding Helmet 9100-QR with 3M™ Speedglas™ Welding Filter 9100X.	58 36 05	Speedglas welding helmet 9100-QR with 9100V welding filter.	58 36 25	Speedglas welding helmet 9100-QR with 9100XX welding filter.

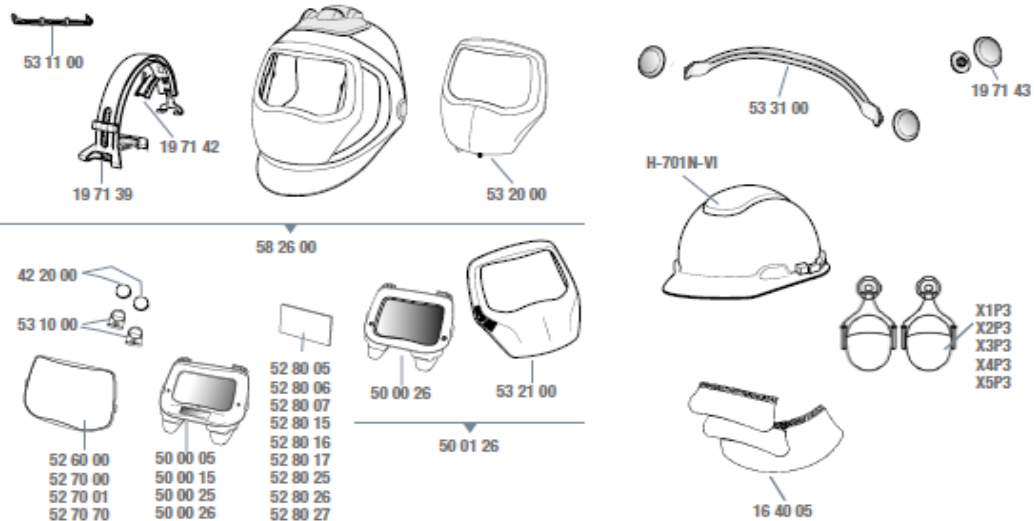

Part No	Description	Part No	Description	Part No	Description
16 40 05	Ear and neck protection in leather. Quick release rail for safety helmet.	52 80 06	Inner cover plate, +1 shade for 9100V filters, pkg of 3.	53 31 00	Ear muff bar for Speedglas welding helmet 9100-QR.
19 71 39	Rubber friction pads for quick release rail.	52 80 07	Inner cover plate, +2 shade for 9100V filters, pkg of 3.	58 16 00	Welding helmet 9100-QR without quick release rail, without welding filter, without safety helmet.
19 71 42	Pivot cover plate kit for quick release welding helmets (QR), pkg of 2.	52 80 15	Inner cover plate for 9100X filter, pkg of 5. Plate marking 117x61.	58 26 00	Welding helmet 9100-QR with quick release rail, without welding filter, without safety helmet.
42 20 00	Battery, pkg of 2.	52 80 16	Inner cover plate, +1 shade for 9100X filter, pkg of 3.	H-701N-VI	3M™ Safety Helmet H-701R (unvented).
50 00 05	Speedglas welding filter 9100V.	52 80 17	Inner cover plate, +2 shade for 9100X filter, pkg of 3.	X1P3	3M™ Peltor™ Ear Muffs X1 (26 dB) for safety helmet.
50 00 15	Speedglas welding filter 9100X.	52 80 25	Inner cover plate for 9100XX filter, pkg of 5. Plate marking 117x77.	X2P3	3M™ Peltor™ Ear Muffs X2 (30 dB) for safety helmet.
50 00 25	Speedglas welding filter 9100XX.	52 80 26	Inner cover plate, +1 shade for 9100XX filter, pkg of 3.	X3P3	3M™ Peltor™ Ear Muffs X3 (32 dB) for safety helmet.
50 01 26	Speedglas welding filter kit 9100XXG (incl new silver front and welding filter)	52 80 27	Inner cover plate, +2 shade for 9100XX filter, pkg of 3.	X4P3	3M™ Peltor™ Ear Muffs X4 (33 dB) for safety helmet.
52 60 00	Outer protection plate standard, pkg of 10.	53 10 00	Battery holder for welding filter series 9100 , pkg of 2.	X5P3	3M™ Peltor™ Ear Muffs X5 (36 dB) for safety helmet.
52 70 00	Outer protection plate scratch resistant, pkg of 10.	53 11 00	Distance bar for welding filters 9100X and 9100XX, pkg of 2.		
52 70 01	Outer protection plate extra scratch resistant, pkg of 10.	53 21 00	Heat-reflecting silver front for welding filter kit 9100XXG.		
52 70 70	Outer protection plate heat resistant, pkg of 10.				
52 80 05	Inner cover plate for 9100V filter, pkg of 5. Plate marking 117x50.				

OPP - Outils de protection personnelles

Speedglas 9100-QR Casque de soudage + Casque de sécurité				9.2	
No° pos.	N° de commande	Description	UNITE	EMB	
Speedglas 100-QR Casque de soudage pour monter sur casque de sécurité					
	3MH582600	Casque de soudure 100-QR avec rail quick-Release, sans filtre de soudure et sans casque	pièce	1	
	3MH701NVI	Casque de sécurité blanc (pas ventilé - bouton rotatif)	pièce	1/20	
Speedglas 9100-QR Accessoires					
	2053564 169100	Cagoule Teca Weld	pièce	1	
	3MH197139	Quick Release rail pour casque de sécurité	pièce	1	
	3MH197142	Fixation en caoutchouc pour QR-rail	set	1	
	3MH531100	Défecteur QR à l'usage du filtre 9100X/9100XX (set de 2 pcs)	pièce	1	
Speedglas Cassette					
	3MH500005	Cassette Speedglas 9100 V 3/5/8/9-13	pièce	1	
	3MH500015	Cassette Speedglas 9100 X 3/5/8/9-13	pièce	1	
	3MH500025	Cassette Speedglas 9100 XX 3/5/8/9-13	pièce	1	
	3MH500026	Cassette Speedglas 9100 XXi 3/5/8/9-13	pièce	1	
	3MH500126	Cassette Speedglas 9100 XXi 3/5/8/9-13 + front anti-chaleur	pièce	1	
	3MH532100	Front anti-chaleur pour commande Xxi cassette	pièce	1	
Speedglas 9100 Ecrans de protection					
	3MH526000	Ecran de protection externe 9100 (set de 10 pcs)	set	1	
	3MH527001	Ecran de protection ext. 9100 résistant au rayures (set de 10 pcs)	set	1	
	3MH527070	Ecran de protection externe - résistant au chaleur (set de 10 pcs)	set	1	
	3MH528005	Ecran de protection interne 9100 V (set de 5 pcs)	set	1	
	3MH528015	Ecran de protection interne 9100 X (set de 5 pcs)	set	1	
	3MH528025	Ecran de protection interne 9100 XX (set de 5 pcs)	set	1	



Compatibility of 3M™ Air Delivery Units and Headtops

The new welding helmets and faceshields from 3M feature the QRS type of breathing tube (Quick Release Swivel), which enables one-handed connection and release. Older types of breathing tubes (non-QRS) can be used by adding the helmet breathing tube adapter (part no 53 35 05).

The new type of QRS breathing tubes are also approved for 3M™ Speedglas™ Welding Helmet Series 9000 and 3M™ Speedglas™ Protective Visors by adding a specific helmet breathing tube adapter (part no 53 35 06).

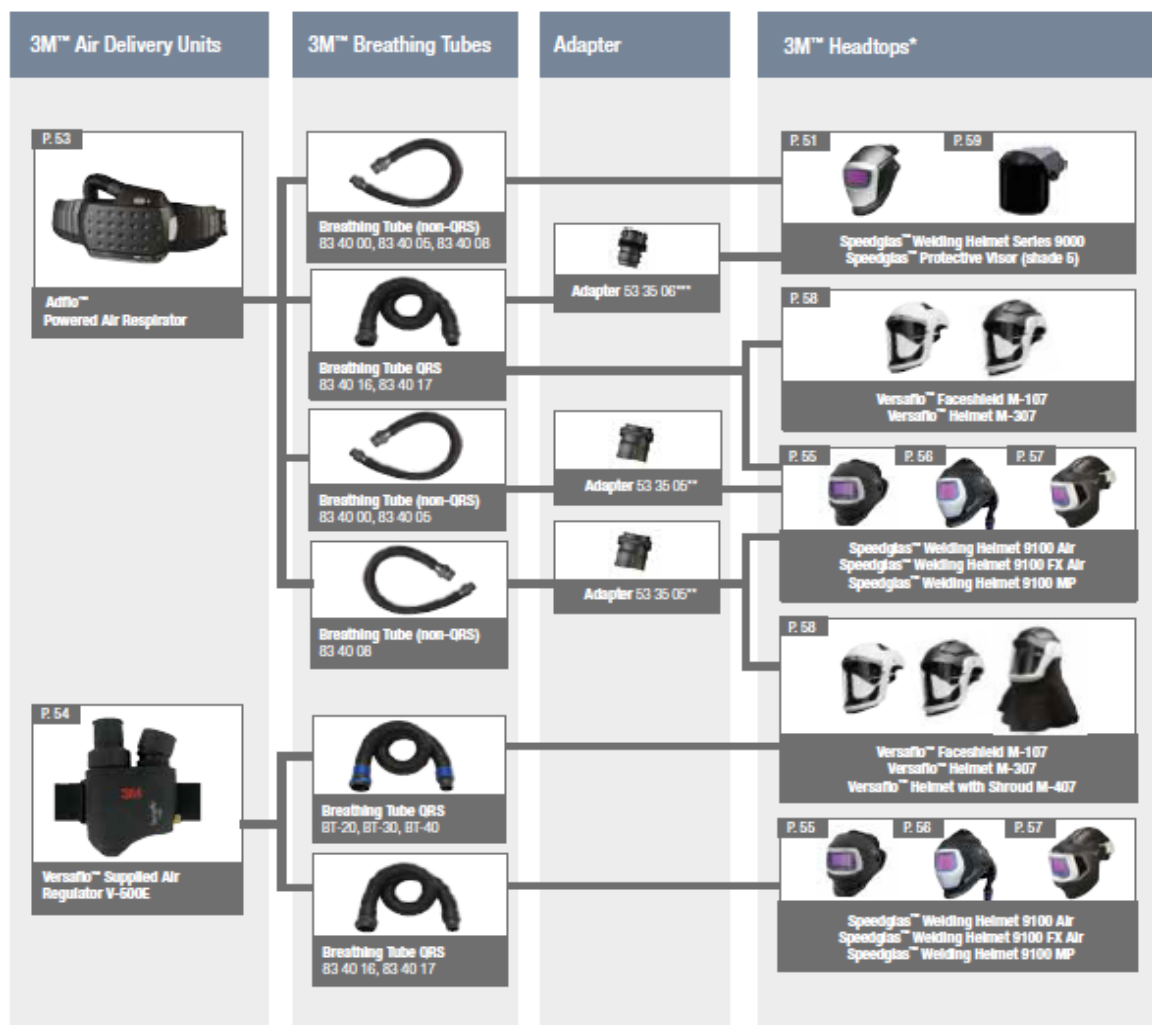

* The Speedglas welding helmet series 9100 replaces most of the Speedglas welding helmet series 9000. Accessories and spare parts for the 9000 helmets will be available for 3-5 years.
 ** The protection class of Speedglas welding helmet 9100 FX Air is reduced to TH2 when the adapter (53 35 05) is used.
 *** When you buy a new complete respirator or regulator with the new breathing tube QRS, it includes the adapter 53 05 06, needed for connecting the Speedglas welding helmet series 9000 and Speedglas visors to the new type of breathing tube.

3M™ Adflo™ Powered Air Respirator



Part No	Description	Part No	Description	Part No	Description
83 77 10	Adflo respirator with self-adjusting breathing tube QRS, adapter (53 35 06), airflow indicator, prefilter, spark arrestor, particle filter and battery.	83 77 31	Adflo respirator as in 83 77 30, but with heavy-duty battery.		adapter (53 35 06), airflow indicator, prefilter, spark arrestor, particle filter, battery, belt and charger.
83 77 30	Adflo respirator with self-adjusting breathing tube QRS, adapter (53 35 06), airflow indicator, prefilter, spark arrestor, particle filter, battery, belt and charger.	83 78 10	Adflo High Altitude respirator with self-adjusting breathing tube QRS, adapter (53 35 06), airflow indicator, prefilter, spark arrestor, particle filter and battery.	83 78 31	High Altitude Adflo respirator as in 83 78 30 but with heavy-duty battery.
		83 78 30	Adflo High Altitude respirator with self-adjusting breathing tube QRS,		

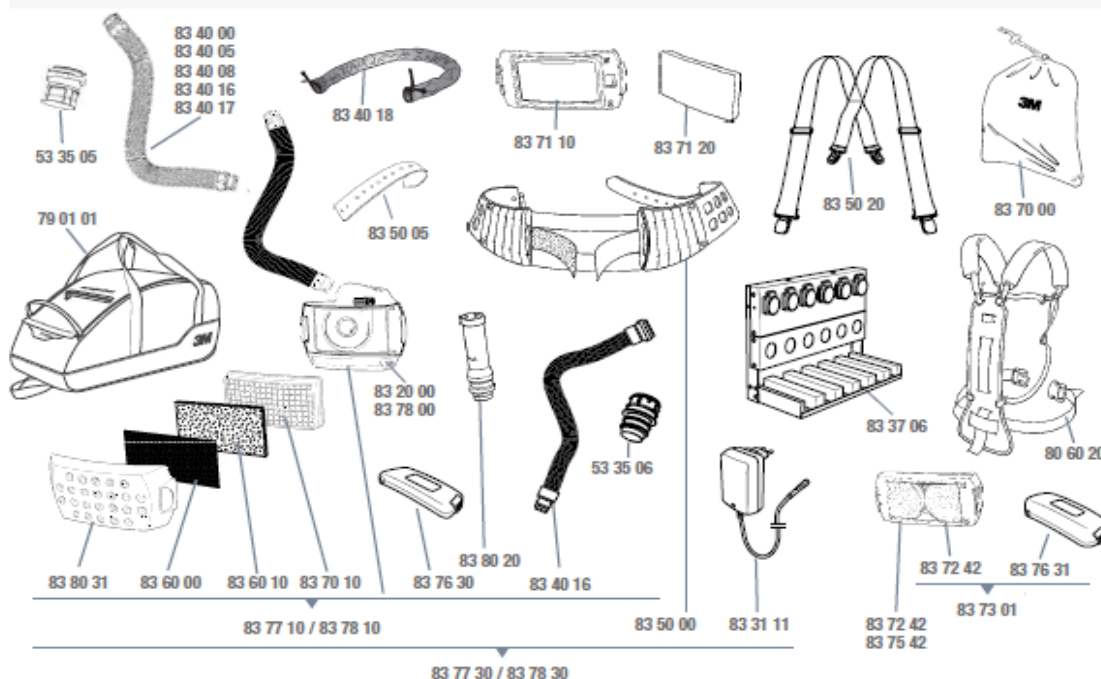

Accessories and spare parts

Part No	Description	Part No	Description	Part No	Description
53 35 05	Adapter for non-QRS breathing tubes when using Speedglas welding helmet series 9100.	83 40 08	Breathing tube with silencer, non-QRS.	83 70 80	Particle filter P SL, pkg of 80.
53 35 06	Adapter for QRS breathing tubes when using Speedglas welding helmet series 9000.	83 40 16	Breathing tube, self-adjusting (52,5 to 85 cm), with QRS connection.	83 71 10	Odour filter.
79 01 01	Product carry bag.	83 40 17	Breathing tube, heavy-duty rubber, with QRS connection.	83 71 20	Odour filter pad.
80 60 20	Backpack.	83 40 18	Flame resistant breathing tube cover.	83 72 42	Gas filter A1B1E1.
83 20 00	Turbo assembly, without filter, without filter cover.	83 50 00	Belt.	83 73 01	Gas filter kit: A1B1E1 filter and Li-ion Heavy-Duty battery.
83 31 01	Battery charger for NiMH batteries.	83 50 05	Front part, belt.	83 75 42	Gas filter A2.
83 31 11	Battery charger for Li-ion batteries.	83 50 10	Quick connection for belt (not shown).	83 76 20	NiMH Battery (standard).
83 37 06	Battery charging stand 6-position.	83 50 20	Braces.	83 76 21	NiMH Battery Heavy-Duty.
83 40 00	Breathing tube, lightweight, non-QRS.	83 60 00	Spark arrestor.	83 76 30	Li-ion Battery (standard).
83 40 05	Breathing tube, heavy-duty rubber, non-QRS.	83 60 10	Prefilter, pkg of 5.	83 76 31	Li-ion Battery Heavy-Duty.
		83 60 80	Prefilter, pkg of 80.	83 78 00	Turbo assembly High Altitude, without filter, without filter cover.
		83 70 00	Storage bag.	83 80 20	Airflow indicator.
		83 70 10	Particle filter P SL.	83 80 31	Filter cover black.
		83 70 20	Particle filter P SL, pkg of 20.		

OPP - Outils de protection personnelles

3M Filtre d'air Adflo actionné par un moteur				9.2	
No° pos.	N° de commande	Description	UNITE	EMB	
	3MH837710	Système Adflo au batterie standard (sans chargeur)	pièce	1	
	3MH837730	Système Adflo+batterie standard+chargeur+ceinture	pièce	1	
		Speedglas ADFLO Accessoires			
	3MH838031	Couvercle noir avec pare-étincelles	pièce	1	
	2053826 836000	Protection contre des étincelles	pièce	1	
	2053827 836010	Préfiltre (set de 5 pcs)	pièce	1	
	2053829 837010	Filtre de particules	pièce	1	
	2053830 837110	Filtre d'odeur	pièce	1	
	2053831 837242	Filtre de gaz A1 B1 E1	pièce	1	
	3MH837301	Kit de filtre de gaz ADFLO(A1B1E1-filtre+heavy duty batterie	pièce	1	
	2053839 837542	Filtre de dissolvant et de gaz Adflo A2 En12941-1998	pièce	1	
	3MH837630	Batterie standard Li-Ion	pièce	1	
	3MH837631	Batterie Li-Ion haute capacité	pièce	1	
	3MH833111	Adflo chargeur pour batterie Li-Ion	pièce	1	
	2053824 835000	Ceinture Adflo Fx	pièce	1	
	2053835 838020	Mètre de courant d'air	pièce	1	
	3MH533505	Adaptateur tuyau d'air sans QRS 9100	pièce	1	
	3MH533506	Adaptateur tuyau d'air avec QRS 9000	pièce	1	
	2053713 834000	Tuyau d'air Adflo 95cm (sans QRS) - 9000	pièce	1	
	2053823 834005	Tuyau d'air de caoutchouc (sans QRS) - 9000	pièce	1	
	3MH834016	Tuyau d'air QRS longueur ajustable 9100	pièce	1	
	3MH834017	Tuyau d'air caoutchouc QRS pour travaux durs 9100	pièce	1	
	3MH834018	Protection pour tuyau respiratoire, anti-flamme	pièce	1	

3M Versaflo V-500E Régulation d'oxygène

9.2

3M™ Versaflo™ Supplied Air Regulator V-500E

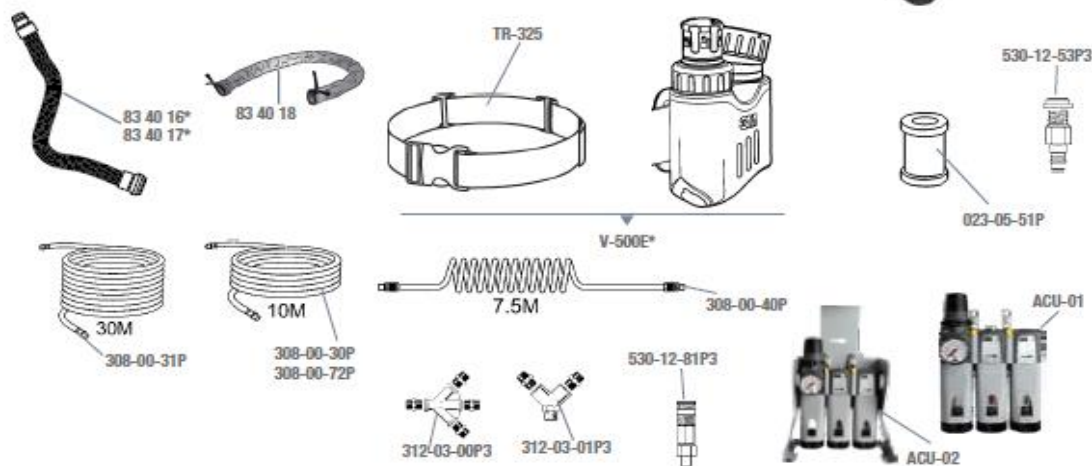

Part No	Description	Part No	Description	Part No	Description
83 40 16	Breathing tube, self-adjusting (52,5 to 85 cm), with QRS connection.	308-00-31P	Standard duty air supply tube, 30 m.	530-12-81P3	Socket and plug - CEJN.
83 40 17	Breathing tube, heavy-duty rubber, with QRS connection.	308-00-40P	Coiled air supply tube, 7.5 m.	ACU-01	3M™ Aircare™ Filtration System (wall mounted).
83 40 18	Flame resistant breathing tube cover.	308-00-72P	Standard duty, anti-static, high temperature air supply tube, 10 m.	ACU-02	3M™ Aircare™ Filtration System (stand alone).
023-05-51P	Carbon filter.	312-03-00P3	3-way manifold.	TR-325	Belt.
308-00-30P	Standard duty air supply tube, 10 m.	312-03-01P3	2-way manifold.	V-500E	Versaflo regulator V-500E with belt.
		530-12-53P3	Belt unit coupling plug - CEJN.		

*When used with Versaflo headhops M-Series, the BT-Series breathing tubes must be used.

Casque de soudage 9000/FlexView/ProTop/Utility fin de la gamme

9.2

No° pos.	N° de commande	Description	UNITE	EMB
	3MH834016	Tuyau d'air QRS longueur ajustable 9100	pièce	1
	3MH834017	Tuyau d'air caoutchouc QRS pour travaux durs 9100	pièce	1
	3MH834018	Protection pour tuyau respiratoire, anti-flamme	pièce	1
	3MTR-325	Ceinture	pièce	1
	3M3080031P	Tuyau d'air standard 30m	pièce	1
	3M3080030P	Tuyau d'air standard 10m	pièce	1
	3MV500E	Vanne de réglage Versaflo V-500E	pièce	1
	3MH3080040P	Tuyau d'air standard 10m	pièce	1
	3MACU-03	Unité de filtre ACU-03 montage de mur	pièce	1
	3MACU-04	Unité de filtre ACU-04 indépendant	pièce	1
	3MACU-20	Filtre de rechange ACU- 20 pour ACU-03 et ACU-04	pièce	1



3M™ Speedglas™ Welding Helmet 9100 Air



Part No	Description	Part No	Description	Part No	Description
56 77 00*	Speedglas welding helmet 9100 Air without welding filter, with Adflo powered air respirator.	56 85 00*	Speedglas welding helmet 9100 Air without welding filter, with VersaFlo supplied air regulator V-500E.	56 90 05*	Upgrade kit for Adflo respirator: welding helmet with 9100V filter, breathing tube (834016) and bag.
56 77 05*	Speedglas welding helmet 9100 Air with 9100V filter and Adflo powered air respirator.	56 85 05*	Speedglas welding helmet 9100 Air with 9100V filter, with VersaFlo supplied air regulator V-500E.	56 90 15*	Upgrade kit for Adflo respirator: welding helmet with 9100X filter, breathing tube (834016) and carry bag.
56 77 15*	Speedglas welding helmet 9100 Air with 9100X filter, with Adflo powered air respirator.	56 85 15*	Speedglas welding helmet 9100 Air with 9100X filter, with VersaFlo supplied air regulator V-500E.	56 90 25*	Upgrade kit for Adflo respirator: welding helmet with 9100XX filter, breathing tube (834016) and carry bag.
56 77 25*	Speedglas welding helmet 9100 Air with 9100XX filter, with Adflo powered air respirator.	56 85 25*	Speedglas welding helmet 9100 Air with 9100XX filter, with VersaFlo supplied air regulator V-500E.		
56 77 26*	Speedglas welding helmet 9100 Air with 9100XX welding filter kit and Adflo powered air respirator.	56 85 26*	Speedglas welding helmet 9100 Air with 9100XX welding filter kit and VersaFlo supplied air regulator V-500E.		

* With bag (79 01 01)

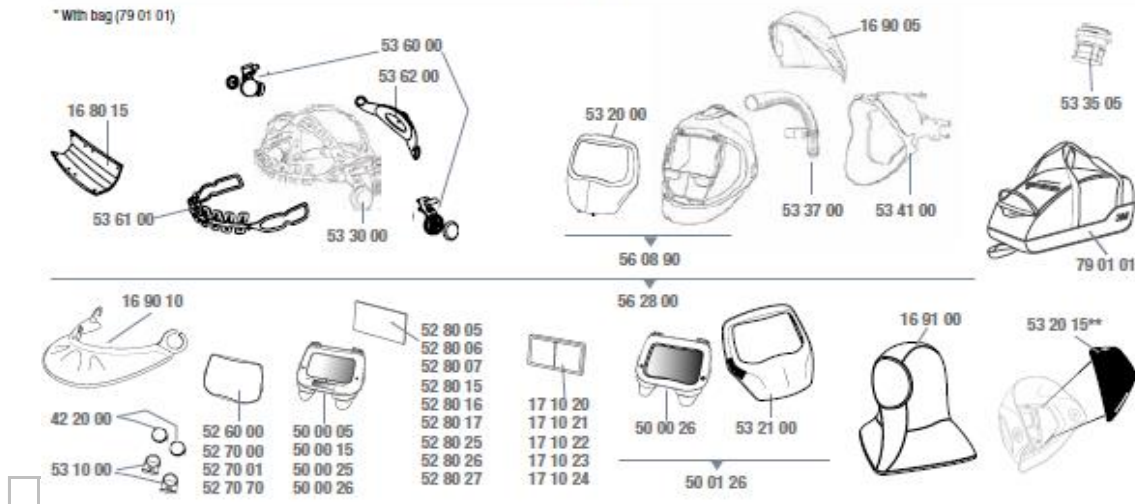

Accessories and spare parts

Part No	Description	Part No	Description	Part No	Description
16 80 15	Comfort sweatband, pkg of 3.	52 70 70	Outer protection plate, heat resistant pkg of 10.	53 20 00	Heat-reflecting silver front.
16 90 05	Head protection, black.	52 80 05	Inner cover plate for 9100V filter, pkg of 5. Plate marking 117x50.	53 20 15*	SideWindows cover plate, 2 pairs.
16 90 10	Neck protection, black.	52 80 06	Inner cover plate, +1 shade for 9100V filters, pkg of 3.	53 21 00	Heat-reflecting silver front for welding filter kit 9100XX.
16 91 00	Hood, black/grey.	52 80 07	Inner cover plate, +2 shade for 9100V filters, pkg of 3.	53 30 00	Speedglas headband 9100 with assembly parts.
17 10 20	Magnifying lens 1.0.	52 80 15	Inner cover plate for 9100X filter, pkg of 5. Plate marking 117x61.	53 35 05	Welding helmet adapter when using old type of breathing tube (non-QRS).
17 10 21	Magnifying lens 1.5.	52 80 16	Inner cover plate, +1 shade for 9100X filter, pkg of 3.	53 37 00	Air duct.
17 10 22	Magnifying lens 2.0.	52 80 17	Inner cover plate, +2 shade for 9100X filter, pkg of 3.	53 41 00	Face seal.
17 10 23	Magnifying lens 2.5.	52 80 25	Inner cover plate for 9100XX filter, pkg of 5. Plate marking 117x77.	53 60 00	Pivot mechanism, left and right.
17 10 24	Magnifying lens 3.0.	52 80 26	Inner cover plate, +1 shade for 9100XX filter, pkg of 3.	53 61 00	Headband front part.
42 20 00	Battery, pkg of 2.	52 80 27	Inner cover plate, +2 shade for 9100XX filter, pkg of 3.	53 62 00	Headband back part.
50 00 05	Speedglas welding filter 9100V.	53 10 00	Battery holder, pkg of 2.	56 08 90*	Speedglas welding helmet 9100 Air without headband, without air duct, without face seal, without filter.
50 00 15	Speedglas welding filter 9100X.			56 28 00	Speedglas welding helmet 9100 Air, without welding filter.
50 00 25	Speedglas welding filter 9100XX.			79 01 01	Product carry bag.
50 00 26	Speedglas welding filter kit 9100XX (incl front and welding filter).				
50 01 26	Speedglas welding filter kit 9100XX (incl front and welding filter).				
52 60 00	Outer protection plate, standard, pkg of 10.				
52 70 00	Outer protection plate, extra scratch resistant, pkg of 10.				

** Please use Part No 56 08 90 when new SideWindows are required.

OPP - Outils de protection personnelles

Speedglas Casque de soudage 9100 Air + Protection de respiration				9.2
No° pos.	N° de commande	Description	UNITE	EMB
		Speedglas 9100 Air Casque + Adflo		
	3MH567715	Speedglas 9100 Air avec cassette 9100X + Adflo + sac	pièce	1
	3MH567725	Speedglas 9100 Air avec cassette 9100XX + Adflo + sac	pièce	1
	3MH567726	Speedglas 9100 Air avec cassette 9100XXi + Adflo + sac	pièce	1
		Speedglas 9100 Air casque + Vanne de règ. Versaflo V-500E		
	3MH568505	Speedglas 9100 Air + cassette 9100V + Vanne de règ. Versaflo V-500E + sac	pièce	1
	3MH568515	Speedglas 9100 Air + cassette 9100X + Vanne de règ. Versaflo V-500E + sac	pièce	1
	3MH568525	Speedglas 9100 Air + cassette 9100XX + Vanne de règ. Versaflo V-500E + sac	pièce	1
	3MH568526	Speedglas 9100 Air + cassette 9100XXi + Vanne de règ. Versaflo V-500E + sac	pièce	1
		Speedglas Cassette		
	3MH500005	Cassette Speedglas 9100 V 3/5/8/9-13	pièce	1
	3MH500015	Cassette Speedglas 9100 X 3/5/8/9-13	pièce	1
	3MH500025	Cassette Speedglas 9100 XX 3/5/8/9-13	pièce	1
	3MH500026	Cassette Speedglas 9100 XXi 3/5/8/9-13	pièce	1
	3MH500126	Cassette Speedglas 9100 XXi 3/5/8/9-13 + front anti-chaleur	pièce	1
	3MH532100	Front anti-chaleur pour commande Xxi cassette	pièce	1
		Speedglas 9100 Air Ecrans de protection		
	3MH526000	Ecran de protection externe 9100 (set de 10 pcs)	set	1
	3MH527001	Ecran de protection ext. 9100 résistant au rayures (set de 10 pcs)	set	1
	3MH527070	Ecran de protection externe - résistant au chaleur (set de 10 pcs)	set	1
	3MH528005	Ecran de protection interne 9100 V (set de 5 pcs)	set	1
	528006	Ecran de protection interne extra couleur DIN 1 pour 9100V (set de 3pcs)	set	1
	528007	Ecran de protection interne extra couleur DIN 2 pour 9100V (set de 3pcs)	set	1
	3MH528015	Ecran de protection interne 9100 X (set de 5 pcs)	set	1
	528016	Ecran de protection interne extra couleur DIN 1 pour 9100X (set de 3pcs)	set	1
	528017	Ecran de protection interne extra couleur DIN 2 pour 9100X (set de 3pcs)	set	1
	H528025	Ecran de protection interne 9100 XX (set de 5pcs)	set	1
	528026	Ecran de protection interne extra couleur DIN 1 pour 9100XX (set de 3pcs)	set	1
	528027	Ecran de protection interne extra couleur DIN 2 pour 9100XX (set de 3pcs)	set	1
		Speedglas 9100 Air Loupes 100 / 9000 / 9002 / 9100 / 9100X / 9100FX		
	2053563	Loupe 1.0 Plastique	pièce	1
	2053560	Loupe 1.5 Plastique	pièce	1
	2053561	Loupe 2.0 Plastique	pièce	1
	2053562	Loupe 2.5 Plastique	pièce	1
	2053567	Loupe 3.0 Plastique	pièce	1
		Speedglas 9100 Air Accessoires		
	2053564	Cagoule Teca Weld	pièce	1
	500026	Cassette Speedglas 9100 XXi 3/5/8/9-13	pièce	1
	532100	Front anti-chaleur pour commande Xxi cassette	pièce	1
	500126	Front reflétant la chaleur, cassette Speedglas 9100XXi inclus	pièce	1
	3MH168015	Bandeau d'aspiration Speedglas 9100 (set de 3 pcs)	set	1
	WE203100V/17	Bandeau SWEATSOPAD 17cm (set de 2 pcs)	paire	1
	2053453	Batterie Speedglas 9000 (set de 2 pcs)	set	1

3M™ Speedglas™ Welding Helmet 9100 FX Air



Part No	Description	Part No	Description	Part No	Description
54 77 00*	Speedglas welding helmet 9100 FX Air, without welding filter, with Adflo powered air respirator.	54 88 00*	Speedglas welding helmet 9100 FX Air, without welding filter, with Versaflo supplied air regulator V-500E.	54 90 05*	Upgrade kit: welding helmet with 9100V filter, breathing tube (834016) and carry bag.
54 77 05*	Speedglas welding helmet 9100 FX Air with 9100V filter, with Adflo powered air respirator.	54 88 05*	Speedglas welding helmet 9100 FX Air with 9100V filter, with Versaflo supplied air regulator V-500E.	54 90 15*	Upgrade kit: welding helmet with 9100X filter, breathing tube (834016) and carry bag.
54 77 15*	Speedglas welding helmet 9100 FX Air with 9100X filter, with Adflo powered air respirator.	54 88 15*	Speedglas welding helmet 9100 FX Air with 9100X filter, with Versaflo supplied air regulator V-500E.	54 90 25*	Upgrade kit: welding helmet with 9100XX filter, breathing tube (834016) and carry bag.
54 77 25*	Speedglas welding helmet 9100 FX Air with 9100XX filter, with Adflo powered air respirator.	54 88 25*	Speedglas welding helmet 9100 FX Air with 9100XX filter, with Versaflo supplied air regulator V-500E.		

* With bag (79 01 01)

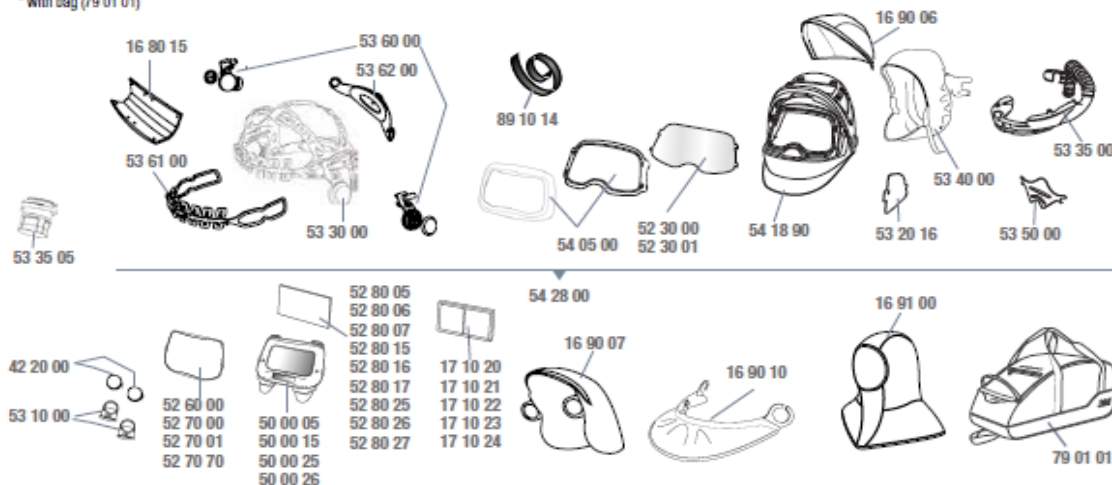

Accessories and spare parts

Part No	Description	Part No	Description	Part No	Description
16 80 15	Comfort sweatband, pkg of 3.	52 70 70	Outer protection plate, heat resistant, pkg of 10.	53 30 00	Speedglas headband 9100, with assembly parts.
16 90 06	Head protection, (small).	52 80 05	Inner cover plate for 9100V filter, pkg of 5. Plate marking 117x50.	53 35 00	Air duct.
16 90 07	Head protection, (large).	52 80 06	Inner cover plate, +1 shade for 9100V filters, pkg of 3.	53 35 05	Adapter for non-ORS breathing tubes when using Speedglas welding helmet series 9100.
16 90 10	Neck protection, black.	52 80 07	Inner cover plate, +2 shade for 9100V filters, pkg of 3.	53 40 00	Face seal.
16 91 00	Hood, black/grey.	52 80 15	Inner cover plate for 9100X filter, pkg of 5. Plate marking 117x61.	53 50 00	Air deflector.
17 10 20	Magnifying lens 1.0.	52 80 16	Inner cover plate, +1 shade for 9100X filter, pkg of 3.	53 60 00	Pivot mechanism, left and right.
17 10 21	Magnifying lens 1.5.	52 80 17	Inner cover plate, +2 shade for 9100X filter, pkg of 3.	53 61 00	Headband, front part.
17 10 22	Magnifying lens 2.0.	52 80 25	Inner cover plate for 9100XX filter, pkg of 5. Plate marking 117x77.	53 62 00	Headband, back part.
17 10 23	Magnifying lens 2.5.	52 80 26	Inner cover plate, +1 shade for 9100XX filter, pkg of 3.	54 05 00	Front cover kit.
17 10 24	Magnifying lens 3.0.	52 80 27	Inner cover plate, +2 shade for 9100XX filter, pkg of 3.	54 18 90	Speedglas welding helmet 9100 FX Air, without filter, without face seal, without air duct, without headband.
42 20 00	Battery, pkg of 2.	52 80 26	Inner cover plate, +1 shade for 9100XX filter, pkg of 3.	54 28 00	Speedglas welding helmet 9100 FX Air, without welding filter, with headband.
50 00 05	Speedglas welding filter 9100V.	52 80 27	Inner cover plate, +2 shade for 9100XX filter, pkg of 3.	79 01 01	Product carry bag.
50 00 15	Speedglas welding filter 9100X.	53 10 00	Battery holder, pkg of 2.	89 10 14	Velcro for Head cover, pkg of 2.
50 00 25	Speedglas welding filter 9100XX.	53 20 16	SideWindows cover plate, 2 pairs.	89 10 15	9100 FX Air service kit (not shown).
50 00 26	Speedglas welding filter 9100XXG.				
52 30 00	Visor plate, standard, pkg of 5.				
52 30 01	Visor plate, anti-fog, pkg of 5.				
52 60 00	Outer protection plate, standard, pkg of 10.				
52 70 00	Outer protection plate scratch resistant, pkg of 10.				
52 70 01	Outer protection plate extra scratch resistant, pkg of 10.				

OPP - Outils de protection personnelles

Casque de soudage 9100 FX Air + Protection de meulage et de respiration				9.2
No° pos.	N° de commande	Description	UNITE	EMB
		Speedglas 9100FX Air casque + Adflo		
	3MH547700	Speedglas 9100 Fx Air sans cassette et Adflo + sac	pièce	1
	3MH547705	Speedglas 9100 Fx Air + cassette 9100V et Adflo + sac	pièce	1
	3MH547715	Speedglas 9100 Fx Air + cassette 9100X + Adflo + sac	pièce	1
	3MH547725	Speedglas 9100 Fx Air + cassette 9100XX + Adflo + sac	pièce	1
	3MH547726	Speedglas 9100 Fx Air + cassette 9100XXi + Adflo + sac	pièce	1
		Speedglas 9100FX Air casque + Versaflo Regulator V-500E		
	3MH548800	Sp. 9100 Fx Air sans cassette et Vanne de règ. Versaflo V-500E + sac	pièce	1
	3MH548805	Sp. 9100 Fx Air + cass. 9100V + Vanne de règ. V-500E Versaflo + sac	pièce	1
	3MH548815	Sp. 9100 Fx Air + cass. 9100X + Vanne de règ. V-500E Versaflo + sac	pièce	1
	3MH548825	Sp. 9100 Fx Air + cass. 9100XX + Vanne de règ. V-500E Versaflo + sac	pièce	1
	3MH548826	Sp. 9100 Fx Air + cass. 9100XXi + Vanne de règ. V-500E Versaflo + sac	pièce	1
		Speedglas 9100FX Air casque + Versaflo Regulator V-500E		
	3MH168015	Bandeau d'aspiration Speedglas 9100 (set de 3 pcs)	set	1
	WE203100V/17	Bandeau SWEATSOPAD 17cm (set de 2 pcs)	paire	1
	2053453	Batterie Speedglas 9000 (set de 2 pcs)	set	1
		Speedglas 9100FX Air Ecrans de protection		
	3MH526000	Ecran de protection externe 9100 (set de 10 pcs)	set	1
	3MH527001	Ecran de protection ext. 9100 résistant au rayures (set de 10 pcs)	set	1
	3MH527070	Ecran de protection externe - résistant au chaleur (set de 10 pcs)	set	1
	3MH528005	Ecran de protection interne 9100 V (set de 5 pcs)	pièce	1
	3MH528006	Ecran de protection interne pour filtre 9100V	pièce	1
	3MH528007	Ecran de protection interne + 2 nuances pour filtres 9100V	pièce	1
	3MH528015	Ecran de protection interne 9100 X (set de 5 pcs)	set	1
	3MH528016	Ecran de protection interne + 1 nuance pour filtre 9100X	pièce	1
	3MH528017	Ecran de protection interne + 2 nuances pour filtre 9100X	pièce	1
	3MH528025	Ecran de protection interne 9100 XX (set de 5 pcs)	pièce	1
	3MH528026	Ecran de protection interne + 1 nuance pour filtre 9100XX	pièce	1
	3MH528027	Ecran de protection interne + 2 nuances filtre 9100XX	pièce	1
		Speedglas Cassettes		
	3MH500005	Cassette Speedglas 9100 V 3/5/8/9-13	pièce	1
	3MH500015	Cassette Speedglas 9100 X 3/5/8/9-13	pièce	1
	3MH500025	Cassette Speedglas 9100 XX 3/5/8/9-13	pièce	1
	3MH500026	Cassette Speedglas 9100 XXi 3/5/8/9-13	pièce	1
		Speedglas Loupes 100 / 9000 / 9002 / 9100 / 9100X / 9100FX		
	2053563	Loupe 1.0 Plastique	pièce	1
	2053560	Loupe 1.5 Plastique	pièce	1
	2053561	Loupe 2.0 Plastique	pièce	1
	2053562	Loupe 2.5 Plastique	pièce	1
	2053567	Loupe 3.0 Plastique	pièce	1
		Speedglas 9100FX Air Accessoires		
	2053564	Cagoule Teca Weld	pièce	1
	3MH500026	Speedglas Welding filter 9100XX	pièce	1
	3MH523000	Verre de protection 9100 Fx (set de 5pcs)	pièce	1
	3MH523001	Verre de protection anti-buée (set de 5 pcs)	pièce	1

Casque de soudage 9100 MP FX Air + Protection de la respiration, tête et meulage 9.2

3M™ Speedglas™ Welding Helmet 9100 MP



57 90 15

Part No	Description	Part No	Description	Part No	Description
57 77 00*	Speedglas welding helmet 9100 MP without welding filter, with Adflo powered air respirator.	57 77 25*	Speedglas welding helmet 9100 MP with 9100XX filter, with Adflo powered air respirator.	57 88 15*	Speedglas welding helmet 9100 MP with 9100XX filter, with VersaFlo supplied air regulator V-500E.
57 77 05*	Speedglas welding helmet 9100 MP with 9100V filter, with Adflo powered air respirator.	57 88 00*	Speedglas welding helmet 9100 MP without welding filter, with VersaFlo supplied air regulator V-500E.	57 88 25*	Speedglas welding helmet 9100 MP with 9100XX filter, with VersaFlo supplied air regulator V-500E.
57 77 15*	Speedglas welding helmet 9100 MP with 9100XX filter, with Adflo powered air respirator.	57 88 05*	Speedglas welding helmet 9100 MP with 9100V filter, with VersaFlo supplied air regulator V-500E.	57 90 15*	Speedglas welding helmet 9100 MP with 9100XX filter and breathing tube.
				57 90 25*	Speedglas welding helmet 9100 MP with 9100XX filter and breathing tube.

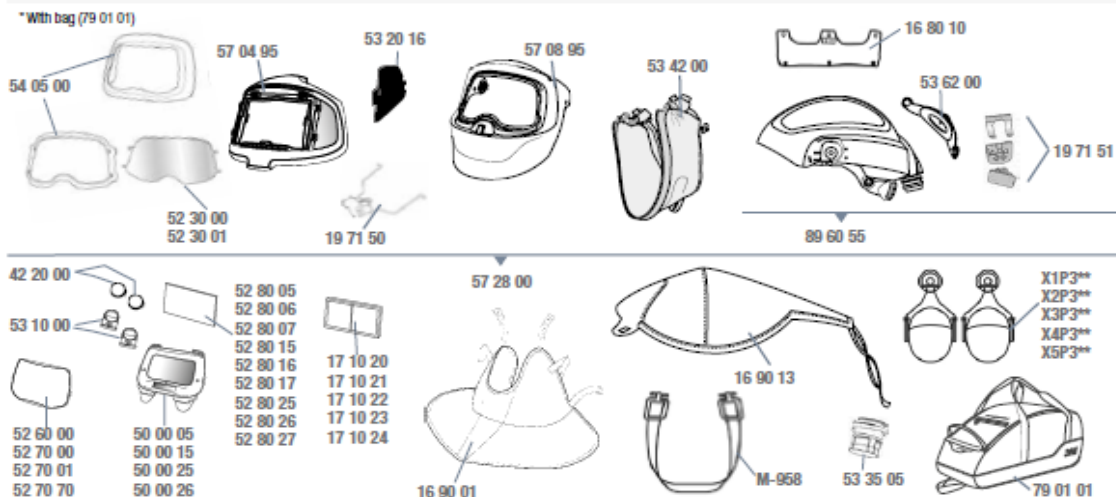

Accessories and spare parts

Part No	Description	Part No	Description	Part No	Description
16 80 10	Sweatband, fleecy cotton, pkg of 2.	52 70 70	Outer protection plate, heat resistant pkg of 10.	53 35 05	Welding helmet adapter when using old type of breathing tube (non-QRS).
16 90 01	Neck protection, black/grey.	52 80 05	Inner cover plate for 9100V filter, pkg of 5. Plate marking 117x50.	53 42 00	Face seal.
16 90 13	Safety helmet cover 9100 MP.	52 80 06	Inner cover plate, +1 shade for 9100V filters, pkg of 3.	53 62 00	Headband ratchet.
17 10 20	Magnifying lens 1.0.	52 80 07	Inner cover plate, +2 shade for 9100V filters, pkg of 3.	54 05 00	Front cover kit.
17 10 21	Magnifying lens 1.5.	52 80 15	Inner cover plate for 9100XX filter, pkg of 5. Plate marking 117x61.	57 04 95	Outer shield.
17 10 22	Magnifying lens 2.0.	52 80 16	Inner cover plate, +1 shade for 9100XX filter, pkg of 3.	57 08 95	Inner shield.
17 10 23	Magnifying lens 2.5.	52 80 17	Inner cover plate, +2 shade for 9100XX filter, pkg of 3.	57 28 00	Speedglas welding and safety helmet 9100 MP, without welding filter.
17 10 24	Magnifying lens 3.0.	52 80 25	Inner cover plate for 9100XX filter, pkg of 5. Plate marking 117x77.		Safety helmet incl pivot kit.
19 71 50	Flip-up mechanism .	52 80 26	Inner cover plate, +1 shade for 9100XX filter, pkg of 3.	79 01 01	Product carry bag.
19 71 51	Pivot kit.	52 80 27	Inner cover plate, +2 shade for 9100XX filter, pkg of 3.	M-350	VersaFlo head suspension M-300 (not shown above).
42 20 00	Battery, pkg of 2.	53 10 00	Battery holder, pkg of 2.	M-958	Chin strap.
50 00 05	Speedglas welding filter 9100V.	53 20 16	SideWindow cover plates.	X1P3	3M™ Peltor™ Ear Muffs X1 (26 dB). **
50 00 15	Speedglas welding filter 9100XX.			X2P3	3M™ Peltor™ Ear Muffs X2 (30 dB). **
50 00 25	Speedglas welding filter 9100XXi.			X3P3	3M™ Peltor™ Ear Muffs X3 (32 dB). **
50 00 26	Speedglas welding filter 9100XXi.			X4P3	3M™ Peltor™ Ear Muffs X4 (33 dB). **
52 30 00	Visor plate, standard, pkg of 5.			X5P3	3M™ Peltor™ Ear Muffs X5 (36 dB). **
52 30 01	Visor plate, anti-fog, pkg of 5.			Z3AF/2	Helmet assembly parts for Peltor X-series ear muffs, left and right (not shown above).
52 60 00	Outer protection plate, standard, pkg of 10.				
52 70 00	Outer protection plate scratch resistant, pkg of 10.				
52 70 01	Outer protection plate extra scratch resistant, pkg of 10.				

** Please add assembly parts Z3AF/2 when ordering hearing protection for 9100MP welding helmet.

OPP - Outils de protection personnelles

Casque de soudage 9100 MP FX Air + Protection de la respiration, tête et meulage				9.2	
No° pos.	N° de commande	Description	UNITE	EMB	
Speedglas 9100MP FX Air casque					
	3MH577705	Speedglas 9100MP FX Air + 9100V + Adflo + sac	pièce	1	
	3MH577715	Speedglas 9100MP FX Air + 9100X + Adflo + sac	pièce	1	
	3MH577725	Speedglas 9100MP FX Air + 9100XX + Adflo + sac	pièce	1	
	3MH577726	Speedglas 9100MP FX Air + 9100XXi + Adflo + sac	pièce	1	
Speedglas 9100MP FX Air casque + Versaflo Regulator V-500E					
	3MH578800	Speedglas 9100MP FX Air sans cassette + Vanne de règ. Versaflo V-500E + sac	pièce	1	
	3MH578805	Speedglas 9100MP FX Air + 9100V + Vanne de règ. Versaflo V-500E + sac	pièce	1	
	3MH578815	Speedglas 9100MP FX Air + 9100X + Vanne de règ. Versaflo V-500E + sac	pièce	1	
	3MH578825	Speedglas 9100MP FX Air + 9100XX + Vanne de règ. Versaflo V-500E + sac	pièce	1	
	3MH578826	Speedglas 9100MP FX Air + 9100XXi + Vanne de règ. Versaflo V-500E + sac	pièce	1	
Speedglas 9100MP Air Ecrans de protection					
	3MH526000	Ecran de protection externe 9100 (set de 10 pcs)	set	1	
	3MH527001	Ecran de protection ext. 9100 résistant au rayures (set de 10 pcs)	set	1	
	3MH527070	Ecran de protection externe - résistant au chaleur (set de 10 pcs)	set	1	
	3MH528005	Ecran de protection interne 9100 V (set de 5 pcs)	set	1	
	3MH528006	Ecran de protection interne pour filtre 9100V	set	1	
	3MH528007	Ecran de protection interne + 2 nuances pour filtres 9100V	set	1	
	3MH528015	Ecran de protection interne 9100 X (set de 5 pcs)	set	1	
	3MH528016	Ecran de protection interne + 1 nuance pour filtre 9100X	set	1	
	3MH528017	Ecran de protection interne + 2 nuances pour filtre 9100X	set	1	
	3MH528025	Ecran de protection interne 9100 XX (set de 5 pcs)	set	1	
	3MH528026	Ecran de protection interne + 1 nuance pour filtre 9100XX	set	1	
	3MH528027	Ecran de protection interne + 2 nuances pour filtre 9100XX	set	1	
Speedglas Cassettes					
	3MH500005	Cassette Speedglas 9100 V 3/5/8/9-13	pièce	1	
	3MH500015	Cassette Speedglas 9100 X 3/5/8/9-13	pièce	1	
	3MH500025	Cassette Speedglas 9100 XX 3/5/8/9-13	pièce	1	
	3MH500026	Cassette Speedglas 9100 XXi 3/5/8/9-13	pièce	1	
Speedglas Loupes 100 / 9000 / 9002 / 9100 / 9100X / 9100FX					
	2053563	Loupe 1.0 Plastique	pièce	1	
	2053560	Loupe 1.5 Plastique	pièce	1	
	2053561	Loupe 2.0 Plastique	pièce	1	
	2053562	Loupe 2.5 Plastique	pièce	1	
	2053567	Loupe 3.0 Plastique	pièce	1	
Speedglas 9100MP Air Accessoires					
	3MH523000	Verre de protection 9100 Fx (set de 5pcs)	pièce	1	
	3MH523001	Verre de protection anti-buée (set de 5 pcs)	set	1	
	2053516	Bandeau d'aspiration coton avec auto-agrippant (set de 2 pcs)	set	1	
	2053453	Batterie Speedglas 9000 (set de 2 pcs)	set	1	

OPP - Outils de protection personnelles

3M Protection de la tête et respiration M-Série avec Adflo-Versaflo V-500E

9.2

3M™ Versaflo™ Headtops M-Series



Part No	Description	Part No	Description	Part No	Description
84 77 20	Versaflo Faceshield M-107 with Adflo respirator.	85 77 20	Versaflo Helmet M-307 with Adflo respirator.	M-107*	Versaflo Faceshield M-107.
				M-307*	Versaflo Helmet M-307.
				M-407*	Versaflo Helmet with shroud M-407.

* For supplied air respirator system, please see page 54 to order regulator. For M-407 helmet with powered air respirator, please see page 53 for further details.

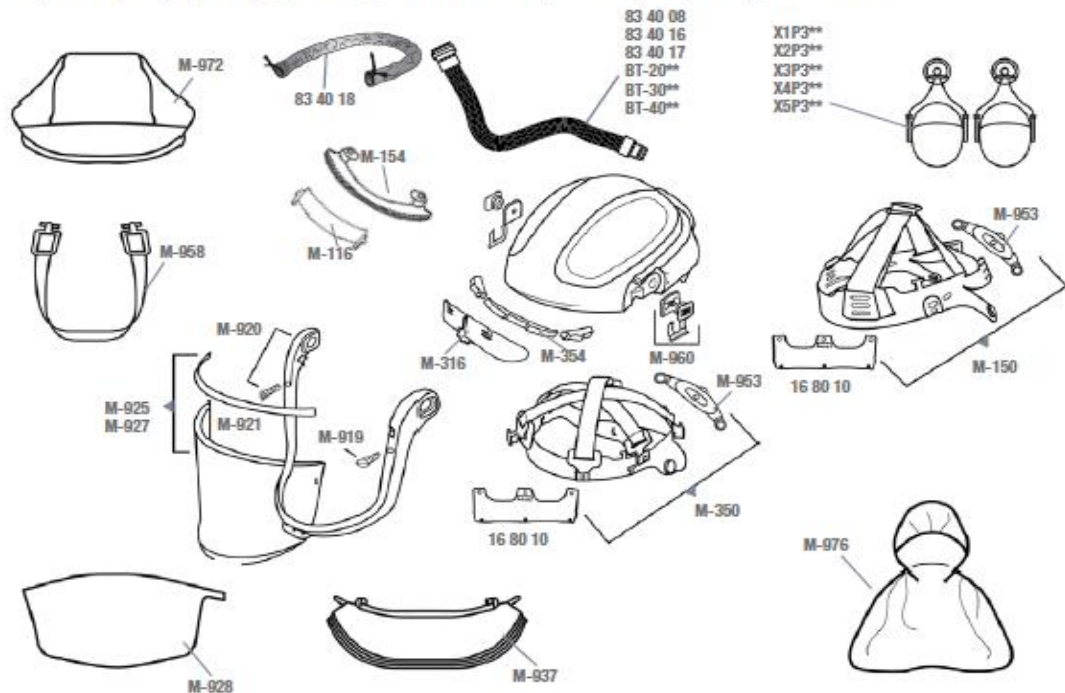

Accessories and spare parts

Part No	Description	Part No	Description	Part No	Description
16 80 10	Sweatband, fleecy cotton, pkg of 2	M-154	Forehead seal (M-107).	M-972	Flame resistant headtop cover.
83 40 08	Breathing tube with silencer, non-QRS.	M-316	Airflow deflector (M-307).	M-976	Head, neck and shoulder cover.
83 40 16	Breathing tube, self-adjusting (52.5 to 85 cm), with QRS connection.	M-350	Head suspension (M-307).	X1P3	3M™ Peltor™ Ear Muffs X1 (26 dB).***
83 40 17	Breathing tube, heavy-duty rubber, with QRS connection.	M-354	Forehead seal (M-307).	X2P3	3M™ Peltor™ Ear Muffs X2 (30 dB).***
83 40 18	Flame resistant breathing tube cover.	M-919	Visor frame buttons.	X3P3	3M™ Peltor™ Ear Muffs X3 (32 dB).***
BT-20 S&L**	Breathing tube, polyurethane (in two lengths), with QRS connection.	M-920	Visor frame.	X4P3	3M™ Peltor™ Ear Muffs X4 (33 dB).***
BT-30**	Breathing tube, self-adjusting (52.5 to 85 cm), with QRS connection.	M-921	Visor gasket.	X5P3	3M™ Peltor™ Ear Muffs X5 (36 dB).***
BT-40**	Breathing tube, heavy-duty rubber, with QRS connection.	M-925	Visor standard (uncoated), molten metal splash protection to EN166.	Z3AF/2	Helmet assembly parts for Peltor X-series ear muffs, left and right (not shown above).
M-116	Airflow deflector (M-107).	M-927	Visor coatad.		
M-150	Head suspension (M-107).	M-928	Peel-off visor cover.		
		M-937	Flame resistant faceseal.		
		M-953	Ratchet.		
		M-956	Ratchet comfort pad.		
		M-958	Chin strap.		
		M-960	Pivot kit.		

** When used with 3M™ Versaflo™ Supplied Air Regulator V-500E, the 3M™ Versaflo™ Breathing Tubes BT-series must be used.
*** Please add assembly parts Z3AF/2 when ordering hearing protection for the M-series headtops.

OPP - Outils de protection personnelles

3M Protection de la tête et respiration M-Série avec Adflo-Versaflor V-500E			9.2	
No° pos.	N° de commande	Description	UNITE	EMB
		3M Versaflor M-107 307 Casque de sécurité avec visière et Adflo		
	3MH847720	3M Versaflor M-107 Visière avec Adflo	pièce	1
	3MH857720	3M Versaflor M-307 Casque avec visière et Adflo	pièce	1
	3MM925	Visor standard (non-enduit), protection d'éclaboussure en métal fondu à EN166	pièce	1
	3MM927	Visière enduit Polycarbonate	pièce	1
	3MM928	Feuil de protection visière auto-collant (boîte de 40pcs)	doos	1
	3MM937	Joint faciale	pièce	1
	3MH834016	Tuyau d'air QRS longueur ajustable 9100	pièce	1
	3MH834017	Tuyau d'air caoutchou QRS pour travaux durs 9100	pièce	1
	3MH834018	Protection pour tuyau respiratoire, anti-flamme	pièce	1
	2053516 168010	Bandeau d'aspiration coton avec auto-agrippant (set de 2 pcs)	set	1

3M™ Speedglas™ Welding Helmets and Welding Filters

- Best***
- Better***
- Good***
- Not Recommended***



Technical specification	3M™ Speedglas™ Welding Helmets 9100, 9100 Air and 9100-QR				3M™ Speedglas™ Welding Helmet 9100 MP	
	9100XG	9100XX	9100X	9100V	9100XG	9100XX
3M™ Speedglas™ Welding Filter						
MMAW (Electrode)						
MIG/MAG						
TIG (>20A)						
TIG (1A-20A)						
Plasma (welding and cutting)						
Risk for hidden arc						
Tack welding						
Grinding (welding filter)						
Grinding (clear visor)	N/A					
Viewing area (welding filter)	73x107 mm		54x107 mm	45x93 mm	73x107 mm	
Battery lifetime	1 800 hours	2 000 hours	2 500 hours	2 800 hours	1 800 hours	2 000 hours
Solar cell	No		Yes		No	
Safety Helmet options	Yes (non air version)				Yes	
Classification	1 / 1 / 1 / 2				1 / 1 / 1 / 2	
Dark state	Shade 5, 8, 9-13				Shade 5, 8, 9-13	
Light state	Shade 3				Shade 3	
UV/IR Protection	Shade 13 (permanent)				Shade 13 (permanent)	
Auto ON	Yes	No			Yes	No
Switching time, light-dark	0,1 ms (+23° C)				0,1 ms (+23° C)	
Memory mode	Yes	No			No	
Delay (switching time, dark-light)	40-800 ms	40-1 300 ms			40-800 ms	40-1 300 ms
SideWindows option	Yes				Yes	
Exhaust vents	Yes (non air version)				N/A	
Number of sensors (arc detection)	3				3	
Approvals Eye and Face protection Welding helmet Welding filter Protection plates Visor plate	EN175:B EN 379 EN166:BT* N/A				EN175:B, EN 166 B EN 379 EN166:BT* EN166:BT*	
Approval Head protection Safety helmet	440 Vac (3M™ Safety Helmet H-701)				EN 397 440 Vac, LD	
Approval Respiratory Protection / NPF** Adflo Powered Air Respirator Versaflo V-500 Supplied Air Regulator	with Speedglas welding helmet 9100 Air EN 12941 (TH2) / NPF 50 EN 14594 (3B) / NPF 200				EN12941 (TH3) / NPF 500 EN14594 (3B) / NPF 200 N/A	

* According to the European Standards the mechanical strength (for this product) is classified as B; resistance to high speed particles at medium energy impact (120 m/s). The letter T indicates that the test for resistance to high speed particle was conducted at extremes of temperatures (-5° to +55°C).

** The nominal protection factor based on laboratory-measured performance data according to European Standards. The protection factor is assigned by local authorities in each European country and can therefore be different for each country.

*** The ratings (good - better - best) above refer to the products listed in this chart and should be seen as general recommendations based on differences in product comfort features and configuration options when using these selected Speedglas welding helmet series.

OPP - Outils de protection personnelles

3M							9.2	
No° pos.	N° de commande	Description					UNITE	EMB



3M™ Speedglas™ Welding Helmet 9100 MP		3M™ Speedglas™ Welding Helmets 9100 FX and 9100 FX Air				3M™ Speedglas™ Welding Helmet SL	3M™ Speedglas™ Welding Helmet Series 100 and 100-QR	
9100X	9100V	9100XG	9100XC	9100X	9100V	SL	100V	100S
						N/A		N/A
54x107 mm	45x93 mm	73x107 mm	73x107 mm	54x107 mm	45x93 mm	42x93 mm	44 x 93 mm	
2 500 hours	2 800 hours	1 800 hours	2 000 hours	2 500 hours	2 800 hours	1 500 hours	1 500 hours	
Yes		No		Yes		No	No	
Yes		Yes (non air version)				No	Yes	
1 / 1 / 1 / 2		1 / 1 / 1 / 2				1 / 1 / 1 / 2	1 / 2 / 2 / 2	
Shade 5, 8, 9-13		Shade 5, 8, 9-13				Shade 8-12	Shade 8-12	Shade 10 or 11
Shade 3		Shade 3				Shade 3	Shade 3	
Shade 13 (permanent)		Shade 13 (permanent)				Shade 12 (permanent)	Shade 12 (permanent)	
No		Yes		No		Yes	No	
0,1 ms (+23° C)		0,1 ms (+23° C)				0,1 ms (+23° C)	0,1 ms (+23° C)	
No		No				No	No	
40-1 300 ms		40-800 ms		40-1 300 ms		60-250 ms	40-250 ms	150 or 250 ms
Yes		Yes				No	No	
N/A		Yes (non air version)				No	No	
3		3				2	2	
EN175:B, EN 166 B EN 379 EN166:BT* EN166:BT*		EN175:B, EN 166:B EN 379 EN166:BT* EN166:BT*				EN 175:F EN 379 EN166:FT N/A	EN 175:B EN 379 EN 166:BT* N/A	
EN 397 440 Vac, LD		440 Vac (3M™ Safety Helmet H-701)				N/A	440 Vac (3M™ Safety Helmet H-701)	
EN12941 (TH3) / NPF 500 EN14594 (3B) / NPF 200 N/A		with Speedglas welding helmet 9100 FX Air EN 12941 (TH3) / NPF 500 EN 14594 (3B) / NPF 200				N/A	N/A	

OPP - Outils de protection personnelles

Casque Arc Visor Din 9-13				9.2	
N° pos.	N° de commande	Description	EMB	UNITE	
	TBI714P101021	Casque de soudage Arc Visor Din 9-13	pièce		1
	TBI714P102072	Plaque de prot. intérieur Arc Visor 46x105mm	pièce		1
	TBI714P002072	Plaque de prot. extérieur clear vision 3	pièce		1
	TBI714P002058	Serre tête complet Arc Visor sans bandeau d'aspiration	pièce		1



Casque de soudage Eburon Airflow				9.2	
N° pos.	N° de commande	Description	EMB	UNITE	
	EB-AIR	Eburon Airflow 5-13 adin avec visière pliante	pièce		1

