

EUROFER®

LAVORAZIONE DEL FERRO BATTUTO & ACCIAIO INOX
WROUGHT IRON & STAINLESS STEEL WORKING



OFFER

LA PRODUZIONE COMPLETA
THE WHOLE PRODUCTION



Art. 1000
"Arte dal ferro" / "Art of wrought iron"
 1300 articoli / articles
 2700 variazioni di sezioni e di altezze /
different sections and heights
 50 disegni di composizioni di

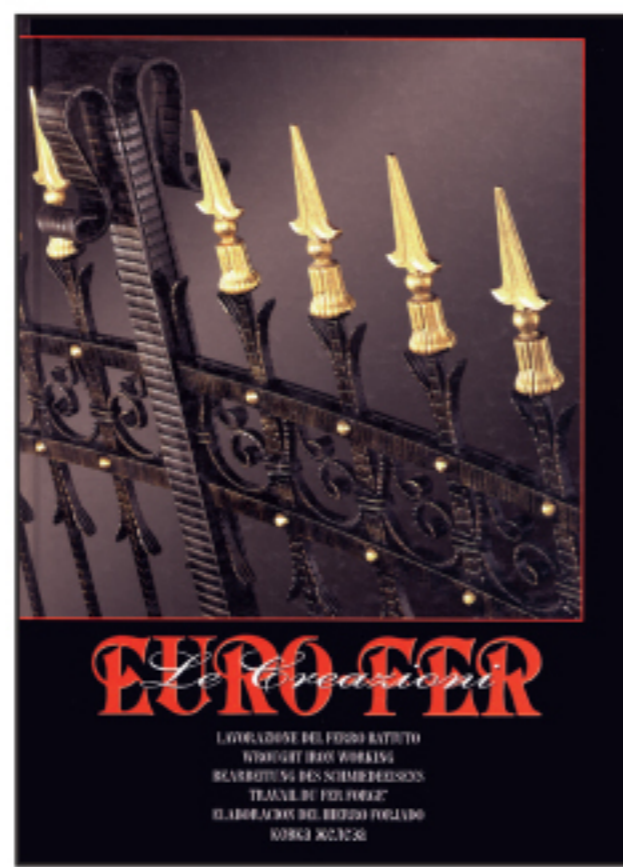

Art. 2000
"Le creazioni Euro-Fer" /
"Euro-Fer creations"
 circa 1000 articoli / articles
 2400 variazioni di sezioni e di altezze /
different sections and heights
 oltre 100 foto di realizzazioni / *more than*
 100 foto of creations



Art. 4000
"Le forme del ferro" /
"The shapes of iron"



Art. 4100
"Tra ferro e fuoco" /
"Between iron and fire"



Art. 5000
"Quaderni 01 2005"



Art. 5001
"Quaderni 02 2005"



Art. 5002
"Le foto"



Art. 10000
"Powder coated products"



Art. 00EZ
"EZ Inox"
 Ez-inox: l'inox facile
 Ez-inox: easy inox



Art. 9000
Cancelli Linear e Gradius
 Moduli zincati pronti per
 l'installazione *Galvanized modules*
 ready to use



Art. 11000
"ROSE"
 Collezione Rose realizzata in ferro battuto
 o in acciaio inox con inserti di cristallo,
 utilizzo per interni. / *Indoor collection*
 Rose, an innovative combination between
 ornamental wrought iron, or stainless
 steel products, made with crystal inserts.



Art. 7002
"La produzione completa"



COLLAGE.01
 Collage 1.0 è un'applicazione nata per
 la creazione di composizioni grafiche
 e la generazione della distinta relativa
 agli articoli Euro-Fer scelti dall'archivio
 fornito. / *Collage 1.0 is an application*
 created to produce graphic compositions
 using Euro-Fer's products.

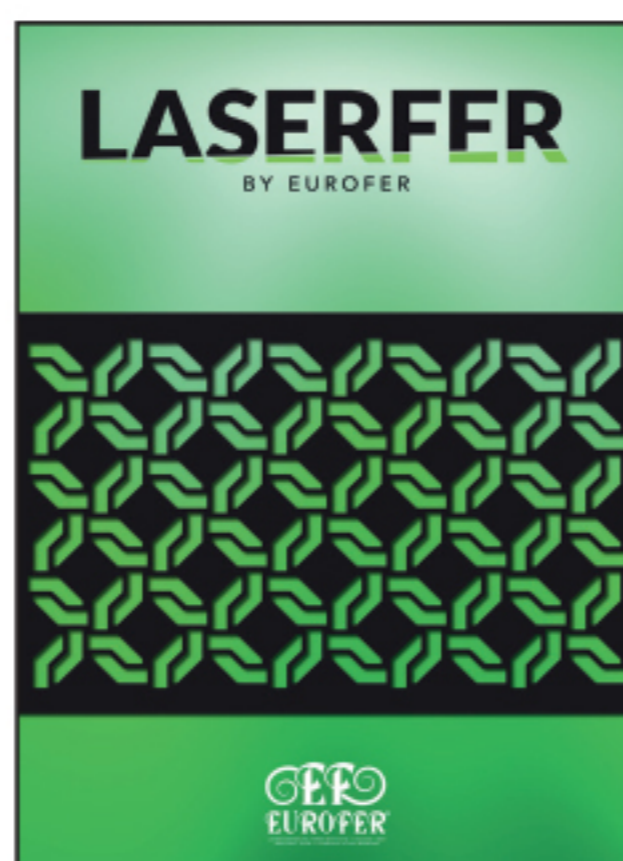

Art. 8000
"Laserfer"



LA PRODUZIONE COMPLETA
THE WHOLE PRODUCTION
LA PRODUCTION COMPLETE

CONDIZIONI GENERALI / GENERAL CONDITIONS

1. Offerte e Ordini
1.1 I tempi di consegna riportati nelle Offerte e nelle Conferme d'Ordine sono puramente indicativi e quindi non vincolanti.
1.2 In nessun caso Euro-Fer Spa potrà essere chiamata a rispondere dei danni direttamente o indirettamente causati dalla ritardata esecuzione di un contratto o dalla ritardata consegna dei prodotti.
1.3 Gli ordini e/o le modifiche di ordini effettuate verbalmente devono essere confermati per iscritto da parte dell'acquirente. In caso contrario Euro-Fer Spa non si assume alcuna responsabilità con riguardo a eventuali errori o possibili fraintendimenti.
1.4 Euro-Fer Spa si riserva la possibilità di frazionare un ordine in più spedizioni.
1.5 I prezzi non sono comprensivi di IVA.

2. Restituzione merci
2.1 Euro-Fer Spa non è obbligata ad accettare resi dei prodotti, salvo che sia stato espressamente pattuito per iscritto. Qualsiasi costo a tal fine è sostenuto dall'Acquirente.
2.2 In tutti i casi Euro-Fer Spa non accetta resi di materiale manomesso o modificato rispetto alla fornitura iniziale.

3. Reclami
3.1 Al momento della presa in consegna dei prodotti l'Acquirente dovrà immediatamente verificare la quantità, l'imballaggio e la conformità, e registrare qualsiasi obiezione nella nota di consegna.
3.2 Ogni denuncia per vizi, dovrà essere effettuata tramite comunicazione scritta entro 8 giorni dall'arrivo della merce.
3.3 La comunicazione di cui al 3.2 dovrà chiaramente identificare la fornitura originale e specificare tipologia e ammontare dei vizi adottati.

4. Varie
4.1 Le misure e le fotografie espresse nel catalogo sono indicative, pertanto i prodotti venduti possono differire leggermente.
4.2 Euro-Fer Spa non accetterà reclami per inconvenienti o anomalie dovuti a applicazioni post-vendita non corrette o non adeguate al prodotto. Trattamenti quali verniciatura, zincatura elettrolitica, zincatura a caldo, sabbiatura, o altri, realizzati dopo la vendita, saranno eseguiti sollevando Euro-fer Spa da qualsiasi responsabilità.
4.3 La riproduzione, anche parziale, del presente catalogo è vietata. Tutti i diritti sono riservati da Euro-Fer Spa.
4.4 I documenti, disegni, dati ed informazioni che dovessero venire consegnati al Cliente, rimangono di esclusiva proprietà di Euro-Fer Spa. Il Cliente si impegna a non riprodurli, a non divulgarli a terzi e ad assumere altresì le opportune cautele nei confronti del proprio personale al fine di garantirne la tutela.
4.5 La gamma di Euro-Fer Spa è composta da articoli di differenti materiali: ferro, acciaio, ottone, ghisa, plastica, cristallo, vetro, etc, ciascuno con le proprie caratteristiche e adatto a particolari utilizzi. E' esclusiva responsabilità del Cliente scegliere i prodotti più indicati alle proprie esigenze ornamentali e di utilizzo.

1. Offers and Orders
1.1 <i>The delivery terms specified in the Offer and in the Order Confirmation are purely indicative and not binding.</i>
1.2 <i>In no case will Euro-Fer Spa be liable for damages directly or indirectly caused by the delayed execution of a contract or the delayed delivery of the products.</i>
1.3 <i>Purchase orders and / or changes to purchase orders made verbally must be confirmed in writing by the Buyer. Otherwise, Euro-Fer Spa assumes no responsibility for any errors or misunderstandings.</i>
1.4 <i>Euro-Fer Spa reserves the right to split a purchase order in several consignments.</i>
1.5 <i>Prices do not include VAT.</i>

2. Return policy
2.1 <i>Euro-Fer Spa is not obliged to accept returns of products, unless expressly agreed in writing. Any cost arising from the return shall be borne by the Buyer.</i>
2.2 <i>In all cases Euro-Fer Spa does not accept returns of material tampered with or modified with respect to what was initially supplied.</i>

3. Claims
3.1 <i>Upon receipt of the products, the Buyer shall immediately check the quantity, packaging and conformity, and record any objections in the delivery note.</i>
3.2 <i>Any complaint for defects must be made by written communication within 8 days of receipt of the goods.</i>
3.3 <i>The written communication relating to paragraph 3.2 must clearly identify the original supply and specify the type and number of defects alleged.</i>

4. Others
4.1 <i>Sizes and pictures shown in the catalogues are indicative, therefore the products may differ slightly.</i>
4.2 <i>Euro-Fer Spa will not accept claims for inconveniences or anomalies due to incorrect or inappropriate after-sales applications of its products. Treatments such as painting, electrolytic zinc-plating, hot dip galvanizing, sandblasting, or others, made after the sale, will be carried out by relieving Euro-fer Spa from any responsibility.</i>
4.3 <i>The reproduction, even partial, of this catalogue is strictly forbidden. All right are reserved by Euro-Fer Spa.</i>
4.4 <i>The documents, drawings, data and information provided from Euro-fer Spa to the Buyer, remain exclusive property of Euro-Fer Spa. The Buyer undertakes not to reproduce them, not to disclose them to third parties and at the same time to take the appropriate precautions toward their staff in order to guarantee its protection.</i>
4.5 <i>Euro-Fer Spa range consists of items made of different materials: iron, steel, brass, cast iron, plastic, crystal, glass, etc., each with its own characteristics and suitable for specific uses. It is sole responsibility of the Buyer to choose the most suitable products for its ornamental and use needs.</i>

Legenda

Le misure sono espresse in millimetri. La lettera "H" sta per altezza e "L" per larghezza, mentre le sezioni sono indicate con i simboli: ≠ Ø □ (piatto, tondo o diametro, quadro). Tra le dimensioni indicate e quelle reali vi possono essere delle lievi differenze, proprio perchè ogni elemento è prodotto in gran parte a mano.

(ca.) - Per le caratteristiche particolari del ferro forgiato, le misure degli articoli che seguono possono subire delle lievi variazioni dovute al tipo di lavorazioni cui sono sottoposti.

All dimensions are expressed in millimeters. The letter "H" stands for height; "L" stands for length, while the shapes of the sections are indicated with the symbols: ≠ Ø □ (flat, round or diameter, square). There may be slight differences between the dimensions indicated and the real dimensions, precisely because each creation is produced in large part by the craftsman's hand.

(ca.) - Because of their peculiarity, the measures of forged bars could be subjected to small variations due to their particular working process.

EURO-FER si riserva di apportare qualsiasi variazione ai dati indicati, al fine di migliorare il prodotto.

EURO-FER retains the right to change the specification indicated in order to improve the product.

A richiesta è possibile realizzare produzioni personalizzate con motivi e misure non presenti in questo catalogo. Le personalizzazioni sono possibili solo per determinate quantità / *Personalized creations with patterns and sizes not illustrated in this catalogues can be ordered on request. Personalized work can be performed only for certain quantities.*

.AL	Articolo realizzato in alluminio
.B	Borchia svasata
.CI	Articolo in ghisa
.CS	Articolo in Fusione
.CO	Superficie tipo 'Corteccia'
.D	Misura intermedia tra l'articolo standard e la versione .E
.E	modello come l'articolo di riferimenti ma 'alleggerito' e quindi più economico
.ES	modello España
.R	Borchia Rullata
.RM	Rigato e Martellato
.S	Smussato
.ZC	Zincato a Caldo
.ZF	Zincato a Freddo
Liquirizia	Modello Rigato, Martellato e Attorcigliato
	Linea Liberty, articoli che possono includere particolari in ghisa o in ferro fuso.

Ricordiamo che il trattamento di zincatura (a caldo o a freddo) serve a proteggere gli articoli in ferro dalla corrosione, non è un trattamento di finitura estetica. Euro-Fer Spa non accetta reclami dovuti all'aspetto della zincatura (opaca o lucida, chiara o scura, presenza di cenere o gocce dal bagno di zinco, etc.).

.AL	<i>Item made of Aluminum</i>
.B	<i>Iron bush with countersunk hole</i>
.CI	<i>Item made of Cast Iron</i>
.CS	<i>Item made of Cast Steel</i>
.CO	<i>"Bark" type surface</i>
.D	<i>Intermediate size between the standard item and the .E version (lightened or smaller)</i>
.E	<i>Item similar to article of reference (same item number) but 'lightened' or smaller and therefore cheaper</i>
.ES	<i>Identifies the 'España' models, popular in particular markets</i>
.R	<i>Iron bush with rolled surface</i>
.RM	<i>Fluted and hammered profile</i>
.S	<i>Edged corners profile</i>
.ZC	<i>Hot-dip galvanized item</i>
.ZF	<i>Cold galvanized item</i>
Liquorice	<i>Fluted, hammered and twisted profile</i>
	<i>The Liberty Line identifies items that can include parts made of cast iron or cast steel.</i>

We remind you that the galvanizing treatment (hot or cold) is used to protect iron products from corrosion, it is not an aesthetic finishing treatment. Euro-Fer Spa doesn't accept complaints regarding the shape of the galvanizing (shiny or matt, light or dark, ashes or drops from the zinc bath, etc.).

	—LEGENDA—	pag. 3
01	RICCI SCROLLS	pag. 5
02	CERCHI, OVALI E PIGNE CIRCLES, OVALS AND BASKETS	pag.30
03	ROSONI E QUADRILOBI ROSETTES AND CLIP-ON-UNITS	pag.36
04	BARRE SAGOMATE - LINEA LIBERTY SHAPED BARS - LIBERTY LINE	pag.52
05	PANNELLI LISCI E PALETTI PER RECINZIONI - MODELLO SNAKE PLAIN PANEL UNITS AND STAKES FOR FENCES - SNAKE MODEL	pag.66
06	PANNELLI MARTELLATI HAMMERED PANELS	pag.100
07	PANNELLI LIQUIRIZIA - PANNELLI RIGATI - TUBO RIGATO LIQUORICE PANELS - FLUTED PANELS -FLUTED TUBE	pag.104
08	BARRE FORATE (Riassunto pag.234) HOLED BARS (Summary pag.234)	pag.107
09	TENDENZE ODIERNE MODERN DESIGNS	pag.121
10	ELEMENTI IN FERRO RICALCATO NEW FORGED BARS	pag.134
11	ELEMENTI IN FERRO FORGIATO E CAPISALDI FORGED BARS AND POSTS	pag.142
12	BARRE CON DIVERSE LAVORAZIONI VARIOUS BARS	pag.160
13	BORCHIE, LANCE E PIASTRE STUDS, SPEARS AND PLATES	pag.176
14	FIORI E FOGLIE FLOWERS AND LEAVES	pag.194
15	CIMASE, TERMINALI ED ELEMENTI VARI ORNAMENTS FOR CARRIAGE GATES AND VARIOUS ELEMENTS	pag.203
16	COMPONENTI VARI PER ARREDAMENTO VARIOUS DECOR ELEMENTS	pag.218
AL	ALLUMINIO ALUMINIUM	pag.228
CI	COMPONENTI IN GHISA ELEMENTS IN CAST IRON	pag.228
ZF	ARTICOLI ZINCATI A FREDDO COLD GALVANIZED ARTICLES	pag.229

terminali tranciati
a freddo
cold cutted ends



H.117 X L.60 mm.
Art. 01.001 □ 8 X 8
Art. 01.002 ≡ 16 X 4
Art. 01.003 ≡ 10 X 5
Art. 01.004 ≡ 12 X 6
Art. 01.005 ≡ 20 X 6
Art. 01.005.01 ≡ 14 X 6
Art. 01.005.02 ≡ 20 X 4



H.125 X L.75 mm. **NEW**
Art. 01.005.11 ≡ 20 X 6
Art. 01.005.12 ≡ 14 X 6
Art. 01.005.14 ≡ 16 X 6



H.135 X L.75 mm.
Art. 01.006 □ 8 X 8
Art. 01.007 ≡ 16 X 4
Art. 01.008 ≡ 10 X 5
Art. 01.009 ≡ 12 X 6
Art. 01.010 ≡ 20 X 6
Art. 01.010.01 ≡ 14 X 6
Art. 01.010.02 ≡ 20 X 4



H.180 X L.105 mm. **NEW**
Art. 01.010.12 ≡ 14 X 6
Art. 01.010.14 ≡ 16 X 6



H.180 X L.85 mm.
Art. 01.011 □ 8 X 8
Art. 01.012 ≡ 16 X 4
Art. 01.013 ≡ 10 X 5
Art. 01.014 ≡ 12 X 6
Art. 01.015 ≡ 20 X 6
Art. 01.015.01 ≡ 14 X 6
Art. 01.015.02 ≡ 20 X 4



H.220 X L.100 mm. **NEW**
Art. 01.015.10 ≡ 12 X 6
H.225 X L.100 mm.
Art. 01.015.20 ≡ 16 X 4



H.220 X L.90 mm.
Art. 01.016 □ 8 X 8
Art. 01.017 ≡ 16 X 4
Art. 01.018 ≡ 12 X 6
Art. 01.018.01 ≡ 14 X 6



H.210 X L.100 mm. **NEW**
Art. 01.018.08 ≡ 16 X 4
Art. 01.018.10 ≡ 12 X 6



H.220 X L.110 mm.
Art. 01.019 □ 8 X 8
Art. 01.020 ≡ 16 X 4
Art. 01.021 ≡ 10 X 5
Art. 01.022 ≡ 12 X 6
Art. 01.023 ≡ 14 X 6
Art. 01.024 ≡ 20 X 6
Art. 01.024.01 ≡ 20 X 4



H.290 X L.120 mm.
Art. 01.025 □ 8 X 8
Art. 01.026 ≡ 16 X 4
Art. 01.027 ≡ 10 X 5
Art. 01.028 ≡ 12 X 6
Art. 01.029 ≡ 14 X 6
Art. 01.030 ≡ 20 X 6
Art. 01.030.01 ≡ 20 X 4



H.325 X L.115 mm. **NEW**
Art. 01.030.10 ≡ 16 X 6



H.360 X L.125 mm.
Art. 01.031 □ 8 X 8
Art. 01.032 ≡ 16 X 4
Art. 01.033 ≡ 10 X 5
Art. 01.034 ≡ 12 X 6
Art. 01.035 ≡ 14 X 6
Art. 01.036 ≡ 20 X 6
Art. 01.036.01 ≡ 20 X 4

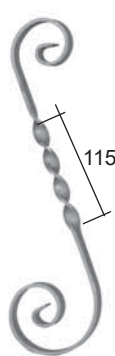

H.350 X L.100 mm.
Art. 01.037 □ 8 X 8
Art. 01.038 ≡ 16 X 4
Art. 01.039 ≡ 10 X 5
Art. 01.040 ≡ 12 X 6
Art. 01.040.01 ≡ 14 X 6



H.290 X L.100 mm. **NEW**
Art. 01.040.08 ≡ 16 X 4
Art. 01.040.10 ≡ 12 X 6



H.290 X L.120 mm.
Art. 01.041 ≡ 16 X 4
Art. 01.042 ≡ 12 X 6
Art. 01.043 ≡ 14 X 6
Art. 01.044 ≡ 20 X 6
Art. 01.044.01 ≡ 20 X 4



H.360 X L.125 mm.
Art. 01.045 ≡ 16 X 4
Art. 01.046 ≡ 12 X 6
Art. 01.047 ≡ 14 X 6
Art. 01.048 ≡ 20 X 6
Art. 01.048.01 ≡ 20 X 4



H.290 X L.125 mm.
Art. 01.049 ≡ 16 X 4



H.450 X L.95 mm.
Art. 01.050 ≡ 16 X 4



H.450 X L.125 mm.
Art. 01.051 ≡ 16 X 4
Art. 01.052 ≡ 20 X 6



H.150 X L.105 mm. **NEW**
Art. 01.052.06 ≡ 14 X 6
Art. 01.052.10 ≡ 16 X 6



Mod. Scala / Scala model
H.115 X L.75 mm.
Art. 01.053 ≙ 12 X 6
Art. 01.054 ≙ 14 X 6
Art. 01.054.01 ≙ 16 X 6



Mod. Scala / Scala model
H.125 X L.90 mm.
Art. 01.055 ≙ 12 X 6
Art. 01.056 ≙ 14 X 6
Art. 01.056.01 ≙ 16 X 6



Mod. Scala / Scala model
H.130 X L.70 mm.
Art. 01.057 ≙ 12 X 6
Art. 01.058 ≙ 14 X 6
Art. 01.058.01 ≙ 16 X 6



Mod. Scala / Scala model
H.150 X L.90 mm.
Art. 01.059 ≙ 12 X 6
Art. 01.059.01 ≙ 12 X 6 (liscio)
Art. 01.060 ≙ 14 X 6
Art. 01.060.01 ≙ 14 X 6 (liscio)
Art. 01.060.02 ≙ 16 X 6
Art. 01.060.03 ≙ 16 X 6 (liscio)



Mod. Scala / Scala model
H.250 X L.130 mm.
Art. 01.061 ≙ 12 X 6
Art. 01.061.01 ≙ 12 X 6 (liscio)
Art. 01.062 ≙ 14 X 6
Art. 01.062.01 ≙ 14 X 6 (liscio)
Art. 01.062.02 ≙ 16 X 6
Art. 01.062.03 ≙ 16 X 6 (liscio)



Mod. Scala / Scala model
H.280 X L.200 mm.
Art. 01.063 □ 12 X 12



Mod. Scala / Scala model
H.230 X L.110 mm.
Art. 01.064 ≙ 12 X 6
Art. 01.065 ≙ 14 X 6
Art. 01.065.01 ≙ 16 X 6



Mod. Scala / Scala model
H.290 X L.115 mm.
Art. 01.066 ≙ 12 X 6
Art. 01.066.01 ≙ 12 X 6 (liscio)
Art. 01.067 ≙ 14 X 6
Art. 01.067.01 ≙ 14 X 6 (liscio)
Art. 01.067.02 ≙ 16 X 6
Art. 01.067.03 ≙ 16 X 6 (liscio)



Mod. Scala / Scala model
H.360 X L.130 mm.
Art. 01.068 ≙ 12 X 6
Art. 01.068.01 ≙ 12 X 6 (liscio)
Art. 01.069 ≙ 14 X 6
Art. 01.069.01 ≙ 14 X 6 (liscio)
Art. 01.069.02 ≙ 16 X 6
Art. 01.069.03 ≙ 16 X 6 (liscio)



Mod. Scala / Scala model
H.290 X L.125 mm.
Art. 01.070 ≙ 12 X 6
Art. 01.070.01 ≙ 12 X 6 (liscio)
Art. 01.071 ≙ 14 X 6
Art. 01.071.01 ≙ 14 X 6 (liscio)
Art. 01.071.02 ≙ 16 X 6
Art. 01.071.03 ≙ 16 X 6 (liscio)



Mod. Scala / Scala model
H.360 X L.125 mm.
Art. 01.072 ≙ 12 X 6
Art. 01.072.01 ≙ 12 X 6 (liscio)
Art. 01.073 ≙ 14 X 6
Art. 01.073.01 ≙ 14 X 6 (liscio)
Art. 01.073.02 ≙ 16 X 6
Art. 01.073.03 ≙ 16 X 6 (liscio)



Mod. Scala / Scala model
H.360 X L.70 mm.
Art. 01.074 □ 8 X 8



Mod. Scala / Scala model
H.360 X L.125 mm.
Art. 01.075 ≙ 12 X 6
Art. 01.076 ≙ 14 X 6
Art. 01.076.01 ≙ 16 X 6



Mod. Scala / Scala model
H.360 X L.125 mm.
Art. 01.077 ≙ 12 X 6
Art. 01.078 ≙ 14 X 6
Art. 01.078.01 ≙ 16 X 6



Mod. Scala / Scala model
H.250 X L.75 mm.
Art. 01.079 ≙ 12 X 6
Art. 01.080 ≙ 14 X 6
Art. 01.080.01 ≙ 16 X 6



Mod. Scala / Scala model
H.120 X L.80 mm.
Art. 01.081 ≙ 12 X 6
Art. 01.082 ≙ 14 X 6
Art. 01.082.01 ≙ 16 X 6



Mod. Scala / Scala model
H.100 X L.65 mm.
Art. 01.083 ≙ 12 X 6
Art. 01.083.27 ≙ 14 X 6
Art. 01.083.28 ≙ 16 X 6



Mod. Scala / Scala model
H.160 X L.80 mm.
Art. 01.083.01 ≙ 12 X 6
Art. 01.083.02 ≙ 14 X 6
Art. 01.083.29 ≙ 16 X 6



Mod. Scala / Scala model
H.210 X L.115 mm.
Art. 01.083.03 ≙ 12 X 6
Art. 01.083.04 ≙ 14 X 6
Art. 01.083.30 ≙ 16 X 6



Mod. Scala / Scala model
H.240 X L.110 mm.
Art. 01.083.07 ≙ 12 X 6
Art. 01.083.08 ≙ 14 X 6
Art. 01.083.32 ≙ 16 X 6



Mod. Scala / Scala model
H.290 X L.110 mm.
Art. 01.083.09 ≙ 12 X 6
Art. 01.083.10 ≙ 14 X 6
Art. 01.083.33 ≙ 16 X 6



Mod. Scala / Scala model
H.230 X L.120 mm.
Art. 01.083.11 ≙ 12 X 6
Art. 01.083.12 ≙ 14 X 6
Art. 01.083.34 ≙ 16 X 6



Mod. Scala / Scala model
H.230 X L.120 mm.
Art. 01.083.13 ≙ 12 X 6
Art. 01.083.14 ≙ 14 X 6
Art. 01.083.35 ≙ 16 X 6



Mod. Scala / Scala model
H.325 X L.80 mm.
Art. 01.083.15 ≙ 12 X 6
Art. 01.083.16 ≙ 14 X 6
Art. 01.083.36 ≙ 16 X 6



Mod. Scala / *Scala model*
H.145 X L.75 mm.
Art. 01.083.17 ≙ 12 X 6
Art. 01.083.18 ≙ 14 X 6
Art. 01.083.37 ≙ 16 X 6



Mod. Scala / *Scala model*
H.110 X L.60 mm.
Art. 01.083.19 ≙ 12 X 6
Art. 01.083.20 ≙ 14 X 6
Art. 01.083.38 ≙ 16 X 6



Mod. Scala / *Scala model*
H.200 X L.100 mm.
Art. 01.083.21 ≙ 14 X 6
Art. 01.083.39 ≙ 16 X 6



Mod. Scala / *Scala model*
H.220 X L.110 mm.
Art. 01.083.22 ≙ 14 X 6
Art. 01.083.41 ≙ 16 X 6



Mod. Scala / *Scala model*
H.380 X L.180 mm.
Art. 01.083.23 ≙ 12 X 6
Art. 01.083.24 ≙ 14 X 6
Art. 01.083.43 ≙ 16 X 6



Mod. Scala / *Scala model*
H.310 X L.35 mm.
Art. 01.083.25 ≙ 14 X 6
Art. 01.083.44 ≙ 16 X 6



Mod. Scala / *Scala model*
H.420 X L.35 mm.
Art. 01.083.26 ≙ 14 X 6



Liscio / *Smooth*
H.220 X L.110 mm.
Art. 01.086.01 ≙ 12 X 6
Art. 01.086.11 ≙ 16 X 8



Liscio / *Smooth*
H.200 X L.100 mm.
Art. 01.086.03 ≙ 12 X 6
Art. 01.086.13 ≙ 16 X 8

Mod. Scala / *Scala model*
H.220 X L.110 mm.
Art. 01.086.02 ≙ 12 X 6

Mod. Scala / *Scala model*
H.200 X L.100 mm.
Art. 01.086.04 ≙ 12 X 6
Art. 01.086.14 ≙ 16 X 8

Martellato / *Hammered*
H.220 x L.110 mm
Art. 01.086.51 ≙ 12 x 6

Martellato / *Hammered*
H.200 x L.100 mm
Art. 01.086.50 ≙ 12 x 6

terminali battuti a caldo
hot forged ends



H.115 X L.80 mm.
Art. 01.084 □ 8 X 8



H.115 X L.80 mm.
Art. 01.084.01 ∅ 8



Mod. Scala / *Scala model*
H.120 X L.75 mm.
Art. 01.085 □ 8 X 8



Mod. Scala / *Scala model*
H.120 X L.75 mm.
Art. 01.086. □ 8 X 8



Martellato / *Hammered*
H.115 x L.75 mm
Art. 01.086.20 ≙ 12 x 6



H.180 X L.110 mm.
Art. 01.087 ≙ 12 X 6

Tutte le parti di questo catalogo - foto comprese - sono di proprietà Euro-Fer. La riproduzione, anche parziale, è vietata in ogni forma e con ogni mezzo. / Every part of this catalogue - photos included - is Euro-Fer's property. All forms of copying are strictly prohibited.

terminali
"a spina di pesce"
"fish bone" ends



H.100 X L.60 mm.
Art. 01.086.05 ≙ 12 X 6
Art. 01.086.06 ≙ 14 X 6
Art. 01.086.15 ≙ 16 X 6
Art. 01.086.18 ≙ 20 X 6



H.125 X L.75 mm.
Art. 01.086.07 ≙ 12 X 6
Art. 01.086.08 ≙ 14 X 6
Art. 01.086.16 ≙ 16 X 6
Art. 01.086.19 ≙ 20 X 6



H.150 X L.80 mm.
Art. 01.086.09 ≙ 12 X 6
Art. 01.086.10 ≙ 14 X 6
Art. 01.086.17 ≙ 16 X 6
Art. 01.086.21 ≙ 20 X 6



H.180 X L.105 mm.
Art. 01.086.24 ≙ 14 X 6
Art. 01.086.25 ≙ 16 X 6
Art. 01.086.26 ≙ 20 X 6



H.200 X L.125 mm.
Art. 01.086.30 ≙ 14 X 6
Art. 01.086.31 ≙ 16 X 6



H.100 X L.65 mm.
Art. 01.086.35 ≙ 14 X 6
Art. 01.086.36 ≙ 16 X 6
Art. 01.086.37 ≙ 20 X 6



H.110 X L.90 mm.
Art. 01.086.40 ≙ 14 X 6
Art. 01.086.41 ≙ 16 X 6
Art. 01.086.42 ≙ 20 X 6



H.150 X L.105 mm.
Art. 01.086.45 ≙ 14 X 6
Art. 01.086.46 ≙ 16 X 6
Art. 01.086.47 ≙ 20 X 6



H.180 X L.125 mm.
Art. 01.086.50 ≙ 14 X 6
Art. 01.086.51 ≙ 16 X 6
Art. 01.086.52 ≙ 20 X 6

NEW



H.180 X L.95 mm.
Art. 01.087.01 □ 10 X 10
Art. 01.087.02 ∅ 8



H.180 X L.95 mm.
Art. 01.088 □ 8 X 8



Mod. Scala / Scala model
H.240 X L.50 mm.
Art. 01.088.01 ≙ 12 X 6
Art. 01.088.02 ≙ 14 X 6



H.250 X L.100 mm.
Art. 01.088.03 □ 8 X 8
Art. 01.088.04 □ 10 X 10
Art. 01.088.05 ∅ 8



H.140 X L.60 mm.
Art. 01.088.06 ∅ 8



H.220 X L.110 mm.
Art. 01.089 □ 8 X 8



H.220 X L.110 mm.
Art. 01.089.01 □ 10 X 10
Art. 01.089.02 ∅ 8



H.170 X L.77 mm.
Art. 01.089.03 ∅ 8



H.290 X L.110 mm.
Art. 01.090 □ 8 X 8



H.290 X L.110 mm.
Art. 01.090.01 □ 10 X 10
Art. 01.090.02 ∅ 8



H.340 x L.90 mm
Art. 01.090.05 □ 8 X 8
Art. 01.090.06 □ 10 X 10



H.360 X L.110 mm.
Art. 01.091 □ 8 X 8
Art. 01.091.01 □ 10 X 10
Art. 01.091.02 ∅ 8

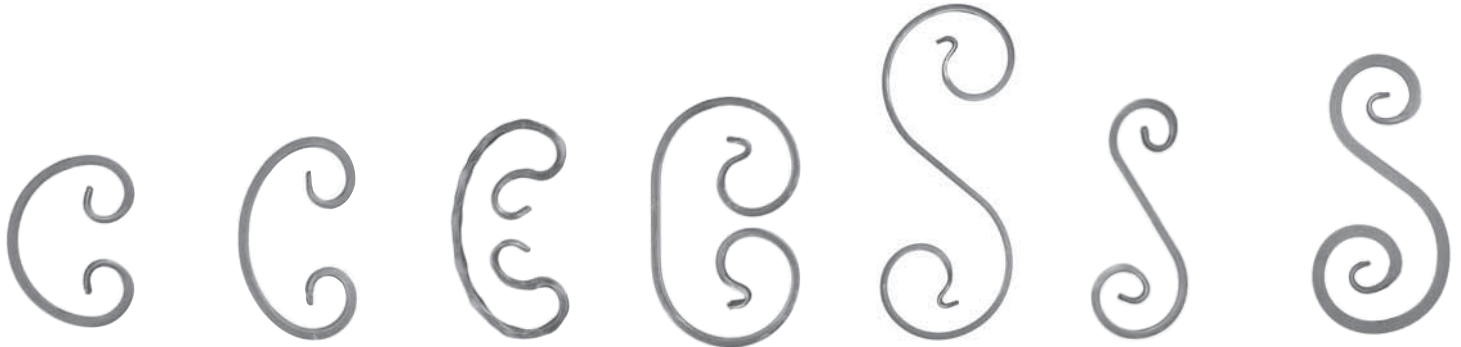

H100 X L.75 mm. Art. 01.091.03 ≙ 12 X 6
 Art. 01.091.04 ≙ 14 X 6
 Art. 01.091.19 ≙ 16 X 6

H.125 X L.70 mm. Art. 01.091.05 ≙ 16 X 6

Martellato / Hammered
 H.145 X L.75 mm. Art. 01.091.06 ≙ 12 X 6

H.175 X L.105 mm. Art. 01.091.07 ≙ 12 X 6
 Art. 01.091.08 ≙ 14 X 6

H.280 X L.110 mm. Art. 01.091.09 ≙ 12 X 6
 Art. 01.091.10 ≙ 14 X 6

H.190 X L.75 mm. Art. 01.091.11 ≙ 12 X 6
 Art. 01.091.12 ≙ 16 X 6
 Art. 01.091.13 ≙ 20 X 6

H.230 X L.110 mm. Art. 01.091.14 □ 10 X 10

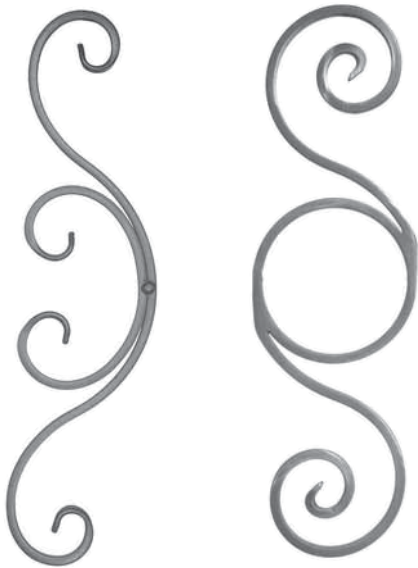

H.360 X L.110 mm. Art. 01.091.15 ≙ 12 X 6

H.430 X L.128 mm. Art. 01.091.16 ≙ 16 X 8



H.200 X L.100 mm. Art. 01.091.17 ≙ 14 X 6
 Art. 01.091.21 ≙ 16 X 6

H.220 X L.110 mm. Art. 01.091.18 ≙ 14 X 6

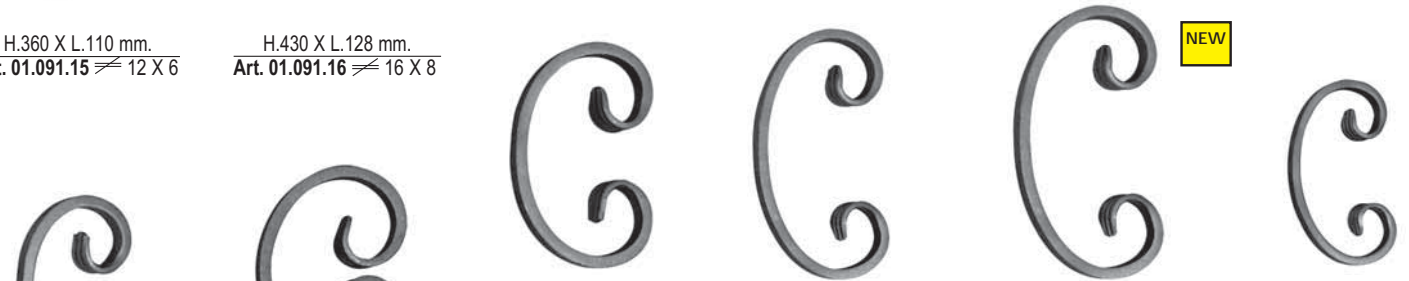

H.95 X L.60 mm. Art. 01.092 ≙ 12 X 6
 Art. 01.092.01 ≙ 14 X 6
 Art. 01.092.02 ≙ 16 X 6

H.105 X L.70 mm. Art. 01.093 ≙ 12 X 6
 Art. 01.093.01 ≙ 14 X 6
 Art. 01.093.02 ≙ 16 X 6

H.115 X L.75 mm. Art. 01.094 ≙ 12 X 6
 Art. 01.094.01 ≙ 14 X 6
 Art. 01.094.04 ≙ 16 X 6

H.110 X L.70 mm. Art. 01.094.02 ≙ 12 X 6
 Art. 01.094.03 ≙ 14 X 6
 Art. 01.094.05 ≙ 16 X 6

H.120 X L.70 mm. Art. 01.095 ≙ 12 X 6
 Art. 01.095.01 ≙ 14 X 6
 Art. 01.095.02 ≙ 16 X 6

H.125 X L.70 mm. Art. 01.095.10 ≙ 12 X 6

H.130 X L.70 mm. Art. 01.096 ≙ 12 X 6
 Art. 01.096.01 ≙ 14 X 6
 Art. 01.096.02 ≙ 16 X 6



H.150 X L.75 mm. Art. 01.097 ≙ 12 X 6
 Art. 01.097.01 ≙ 14 X 6
 Art. 01.097.02 ≙ 16 X 6

H.140 X L.95 mm. Art. 01.098 ≙ 12 X 6
 Art. 01.098.01 ≙ 14 X 6
 Art. 01.098.04 ≙ 16 X 6

H.135 X L.75 mm. Art. 01.098.03 ≙ 12 X 6
 Art. 01.098.05 ≙ 16 X 6

H.120 X L.60 mm. Art. 01.099 ≙ 12 X 6
 Art. 01.099.01 ≙ 14 X 6
 Art. 01.099.02 ≙ 16 X 6

H.150 X L.70 mm. Art. 01.100 ≙ 12 X 6
 Art. 01.100.01 ≙ 14 X 6
 Art. 01.100.02 ≙ 16 X 6
 Art. 01.100.03 ≙ 20 X 6

H.230 X L.115 mm. Art. 01.101 ≙ 12 X 6
 Art. 01.101.01 ≙ 14 X 6
 Art. 01.101.03 ≙ 16 X 6

Tutte le parti di questo catalogo - foto comprese - sono di proprietà Euro-Fer. La riproduzione, anche parziale, è vietata in ogni forma e con ogni mezzo. / Every part of this catalogue - photos included - is Euro-Fer's property. All forms of copying are strictly prohibited.



H.220 X L.110 mm.
Art. 01.101.01
≧ 20 X 6



H.260 X L.115 mm.
Art. 01.102 ≧ 12 X 6
Art. 01.102.01 ≧ 14 X 6
Art. 01.102.02 ≧ 16 X 6



H.115 X L.95 mm.
Art. 01.103 ≧ 12 X 6
Art. 01.103.01 ≧ 14 X 6
Art. 01.103.02 ≧ 16 X 6



H.230 X L.80 mm.
Art. 01.104 ≧ 12 X 6
Art. 01.104.01 ≧ 14 X 6
Art. 01.104.02 ≧ 16 X 6



H.250 X L.75 mm.
Art. 01.105 ≧ 12 X 6
Art. 01.105.01 ≧ 14 X 6
Art. 01.105.03 ≧ 16 X 6



H.250 X L.100 mm.
Art. 01.105.02 □ 10 X 10



H.360 X L.125 mm.
Art. 01.106 ≧ 12 X 6
Art. 01.106.01 ≧ 14 X 6
Art. 01.106.02 ≧ 16 X 6



H.360 X L.130 mm.
Art. 01.107 □ 12 X 12
Art. 01.107.02 □ 14 X 14



H.400 X L.145 mm.
Art. 01.107.01 □ 12 X 12



H.100 X L.65 mm.
Art. 01.108 ≧ 12 X 6
Art. 01.108.01 ≧ 14 X 6
Art. 01.108.02 ≧ 16 X 6



H.120 X L.80 mm.
Art. 01.109 ≧ 12 X 6
Art. 01.109.01 ≧ 14 X 6
Art. 01.109.02 ≧ 16 X 6



H.135 X L.150 mm.
Art. 01.110 ≧ 14 X 6
Art. 01.111 ≧ 16 X 6



Rigato / Fluted
H.160 X L.100 mm.
Art. 01.112
≧ 16 X 8



Rigato / Fluted
H.300 X L.70 mm.
Art. 01.113
≧ 16 X 8



H.460 X L.90 mm.
Art. 01.113.01 ≧ 12 X 6



Modello Scala / Scala Model
H.460 X L.90 mm.
Art. 01.113.02 ≧ 12 X 6



Rigato / Fluted
H.360 X L.110 mm.
Art. 01.114 ≧ 12 X 6



H.240 X L.55 mm.
Art. 01.114.01 ≧ 12 X 3



H.250 X L.55 mm.
Art. 01.114.02 ≧ 12 X 3



H.270 X L.90 mm.
Art. 01.114.03 ≧ 12 X 5



H.280 X L.45 mm.
Art. 01.114.04 ≧ 12 X 3



Rigato / Fluted
H.180 X L.120 mm.
Art. 01.114.05 ≧ 16 X 8



Rigato / Fluted
H.180 X L.120 mm.
Art. 01.114.06 ≧ 16 X 8



Rigato / Fluted
H.210 X L.150 mm.
Art. 01.114.07 ≧ 16 X 8



Rigato / Fluted
H.210 X L.150 mm.
Art. 01.114.08 ≧ 16 X 8

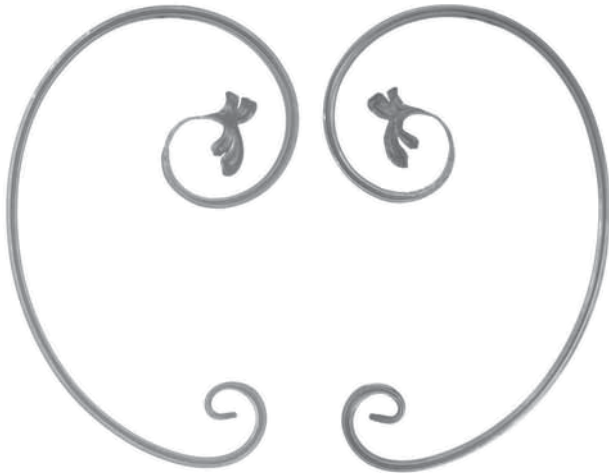

Rigato / Fluted
H.360 X L.230 mm.
Art. 01.114.09 ≙ 16 X 8



Rigato / Fluted
H.360 X L.230 mm.
Art. 01.114.10 ≙ 16 X 8

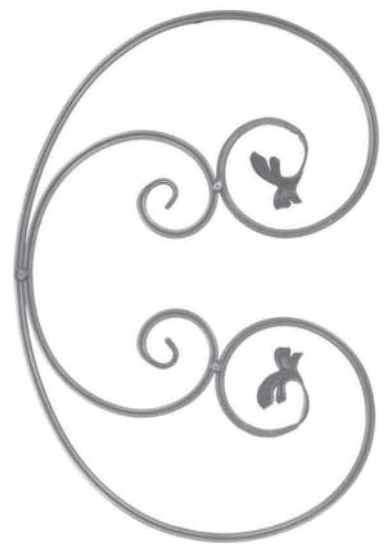

Rigato / Fluted
H.480 X L.320 mm.
Art. 01.114.12 ≙ 16 X 8

Rigato / Fluted
H.480 X L.340 mm.
Art. 01.114.11 ≙ 16 X 8



Rigato / Fluted
H.410 X L.150 mm.
Art. 01.114.13 ≙ 16 X 8



Rigato / Fluted
H.410 X L.150 mm.
Art. 01.114.14 ≙ 16 X 8



Rigato / Fluted
H.510 X L.270 mm.
Art. 01.114.15 ≙ 16 X 8



Rigato / Fluted
H.510 X L.270 mm.
Art. 01.114.16 ≙ 16 X 8



Rigato / Fluted
H.610 X L.250 mm.
Art. 01.114.17 ≙ 16 X 8

Rigato / Fluted
H.610 X L.250 mm.
Art. 01.114.18 ≙ 16 X 8



Rigato / Fluted
H.240 X L.80 mm.
Art. 01.114.19 ≙ 16 X 8



Rigato / Fluted
H.240 X L.80 mm.
Art. 01.114.20 ≙ 16 X 8



Rigato / Fluted
H.190 X L.110 mm.
Art. 01.114.21 ≙ 16 X 8



Rigato / Fluted
H.270 X L.190 mm.
Art. 01.114.22 ≙ 16 X 8



Rigato / Fluted
H.350 X L.220 mm.
Art. 01.114.23 ≙ 16 X 8



Rigato / Fluted
H.210 X L.150 mm.
Art. 01.114.24 ≙ 16 X 8



Rigato / Fluted
H.360 X L.230 mm.
Art. 01.114.26 ≙ 16 X 8



H.400 X L.150 mm.
Art. 01.115 ≙ 12 X 6



H.400 X L.150 mm.
Art. 01.116 ≙ 12 X 6



H.205 X L.150 mm.
Art. 01.117 ≙ 12 X 6
Art. 01.117.01 ≙ 14 X 6
Art. 01.117.02 ≙ 16 X 6



H.250 X L.150 mm.
Art. 01.118 ≙ 12 X 6
Art. 01.118.03 ≙ 14 X 6
Art. 01.118.04 ≙ 16 X 6
Art. 01.118.05
≙ 12 X 6 Mod. Scala / Scala Model
Art. 01.118.06
≙ 16 X 5 Martellato / Hammered



H.250 X L.150 mm.
Art. 01.118.01 Ø 10



Liscio / Smooth
H.500 x L.310 mm
Art. 01.118.10 ≙ 12 x 6



H.200 X L.125 mm.
Art. 01.119 ≙ 12 X 6



H.200 X L.125 mm.
Art. 01.120 ≙ 12 X 6



H.115 X L.100 mm.
Art. 01.120.01 ≙ 12 X 6



H.115 X L.100 mm.
Art. 01.120.02 ≙ 12 X 6



H.80 X L.325 mm.
Art. 01.121 ≙ 12 X 6
Art. 01.121.01 ≙ 14 X 6



Martellato / Hammered
H.175 X L.115 mm.
Art. 01.122 ≙ 16 X 8



Martellato / Hammered
H.125 X L.80 mm.
Art. 01.123 ≙ 16 X 8



Martellato / Hammered
H.115 X L.65 mm.
Art. 01.124 ≙ 16 X 8



Martellato / Hammered
H.225 X L.140 mm.
Art. 01.125 ≙ 16 X 8

Tutte le parti di questo catalogo - foto comprese - sono di proprietà Euro-Fer. La riproduzione, anche parziale, è vietata in ogni forma e con ogni mezzo. / Every part of this catalogue - photos included - is Euro-Fer's property. All forms of copying are strictly prohibited.

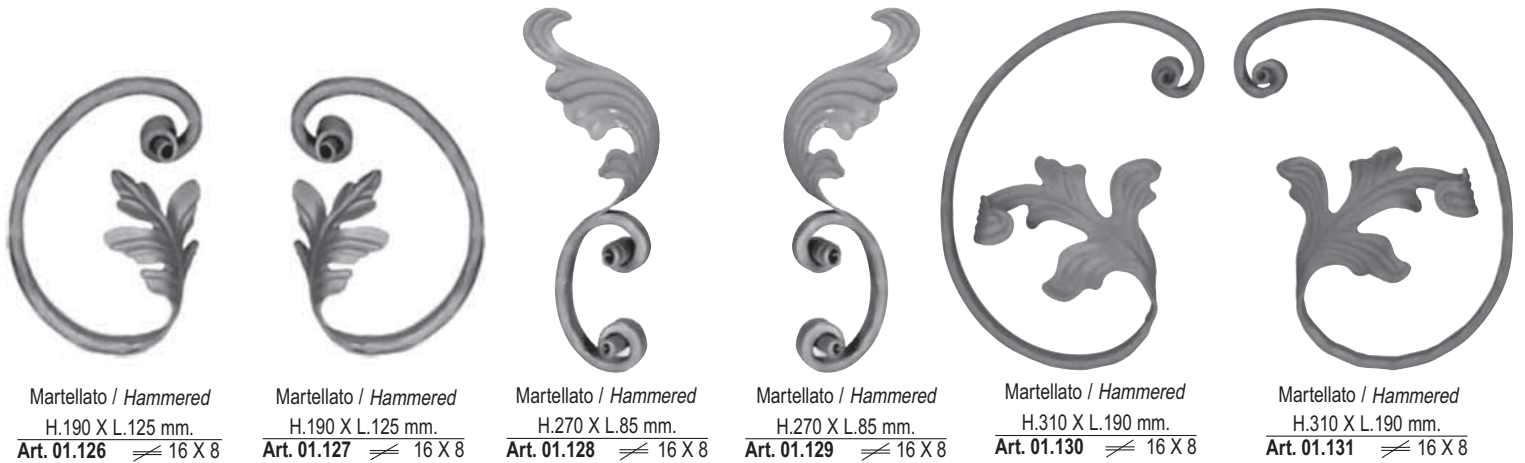

Martellato / Hammered
H.190 X L.125 mm.
Art. 01.126 ≙ 16 X 8

Martellato / Hammered
H.190 X L.125 mm.
Art. 01.127 ≙ 16 X 8

Martellato / Hammered
H.270 X L.85 mm.
Art. 01.128 ≙ 16 X 8

Martellato / Hammered
H.270 X L.85 mm.
Art. 01.129 ≙ 16 X 8

Martellato / Hammered
H.310 X L.190 mm.
Art. 01.130 ≙ 16 X 8

Martellato / Hammered
H.310 X L.190 mm.
Art. 01.131 ≙ 16 X 8

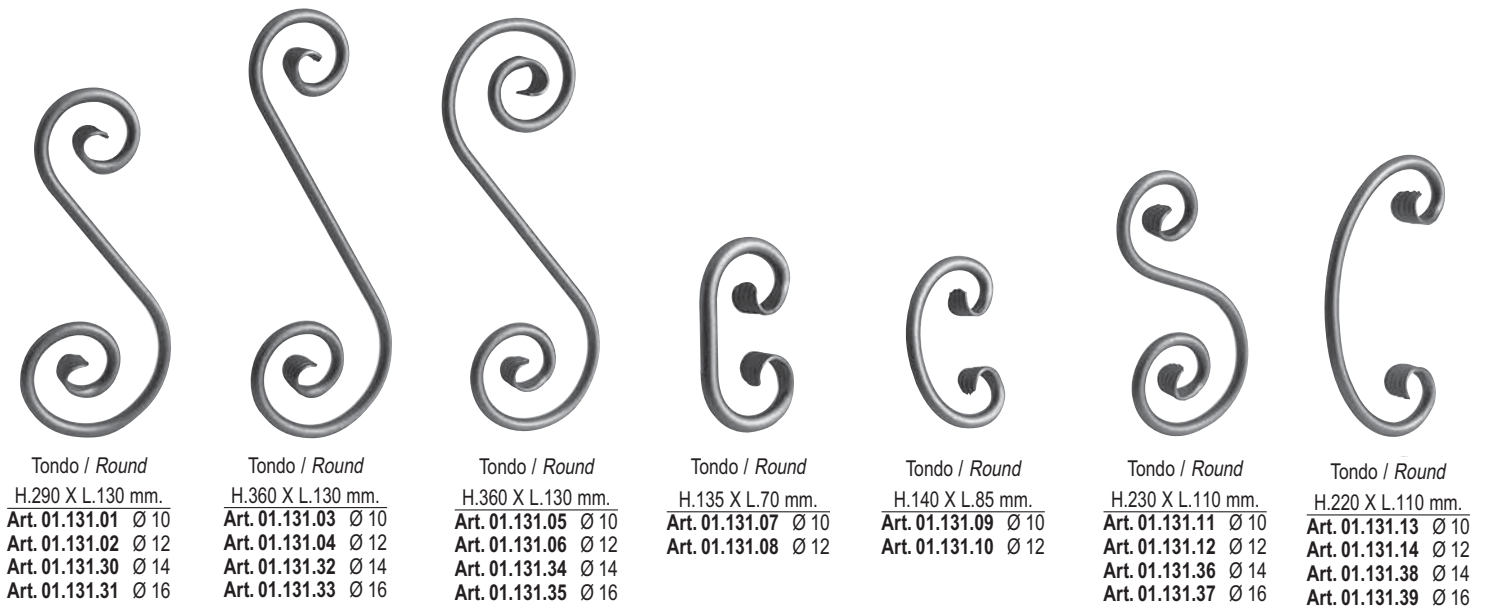

Tondo / Round
H.290 X L.130 mm.
Art. 01.131.01 Ø 10
Art. 01.131.02 Ø 12
Art. 01.131.30 Ø 14
Art. 01.131.31 Ø 16

Tondo / Round
H.360 X L.130 mm.
Art. 01.131.03 Ø 10
Art. 01.131.04 Ø 12
Art. 01.131.32 Ø 14
Art. 01.131.33 Ø 16

Tondo / Round
H.360 X L.130 mm.
Art. 01.131.05 Ø 10
Art. 01.131.06 Ø 12
Art. 01.131.34 Ø 14
Art. 01.131.35 Ø 16

Tondo / Round
H.135 X L.70 mm.
Art. 01.131.07 Ø 10
Art. 01.131.08 Ø 12

Tondo / Round
H.140 X L.85 mm.
Art. 01.131.09 Ø 10
Art. 01.131.10 Ø 12

Tondo / Round
H.230 X L.110 mm.
Art. 01.131.11 Ø 10
Art. 01.131.12 Ø 12
Art. 01.131.36 Ø 14
Art. 01.131.37 Ø 16

Tondo / Round
H.220 X L.110 mm.
Art. 01.131.13 Ø 10
Art. 01.131.14 Ø 12
Art. 01.131.38 Ø 14
Art. 01.131.39 Ø 16

Tutte le parti di questo catalogo - foto comprese - sono di proprietà Euro-Fer. La riproduzione, anche parziale, è vietata in ogni forma e con ogni mezzo. / Every part of this catalogue - photos included - is Euro-Fer's property. All forms of copying are strictly prohibited.



Tondo / Round
H.190 X L.100 mm.
Art. 01.131.15 Ø 10
Art. 01.131.16 Ø 12
Art. 01.131.40 Ø 14



Tondo / Round
H.290 X L.115 mm.
Art. 01.131.17 Ø 10
Art. 01.131.18 Ø 12
Art. 01.131.41 Ø 14



Tondo / Round
H.360 X L.120 mm.
Art. 01.131.19 Ø 10
Art. 01.131.20 Ø 12
Art. 01.131.42 Ø 14



Tondo / Round
H.370 X L.80 mm.
Art. 01.131.21 Ø 12
Art. 01.131.43 Ø 14



Tondo / Round
H.370 X L.120 mm.
Art. 01.131.22 Ø 10
Art. 01.131.60 Ø 12
Art. 01.131.61 Ø 14



Tondo / Round
H.550 X L.120 mm.
Art. 01.131.23 Ø 10
Art. 01.131.62 Ø 12
Art. 01.131.63 Ø 14



Tondo / Round
H.420 X L.210 mm.
Art. 01.131.24 Ø 10
Art. 01.131.64 Ø 12
Art. 01.131.65 Ø 14



Tondo / Round
H.700 X L.220 mm.
Art. 01.131.25 Ø 12
Art. 01.131.66 Ø 14



H.420 X L.220 mm.
Art. 01.131.29 Ø 10
Art. 01.131.67 Ø 12
Art. 01.131.68 Ø 14



H.270 x L.110 mm
Art. 01.131.50 □ 8 X 8



H.690 x L.250 mm
Art. 01.131.70 Ø 14
Art. 01.131.71 Ø 16



H.180 X L.400 mm.
Art. 01.132 ≙ 16 X 5



H.160 X L.470 mm.
Art. 01.133 ≙ 12 X 6



H.200 X L.730 mm.
Art. 01.133.01 ≙ 12 X 6



H.200 X L.770 mm.
Art. 01.134 ≙ 16 X 4



H.250 X L.900 mm.
Art. 01.135 ≙ 16 X 4



H.300 X L.900 mm.
Art. 01.136 ≙ 20 X 5



Modello Scala / Scala Model
H.470 X L.750 mm.
Art. 01.136.01 ≙ 14 X 6



Martellato / Hammered
H.400 X L.950 mm.
Art. 01.136.02 ≙ 25 X 6



Martellato sinistro / Hammered left
H.530 X L.1630 mm.
Art. 01.136.03 ≙ 25 X 6

Martellato destro / Hammered right
H.530 X L.1630 mm.
Art. 01.136.04 ≙ 25 X 6

Tutte le parti di questo catalogo - foto comprese - sono di proprietà Euro-Fer. La riproduzione, anche parziale, è vietata in ogni forma e con ogni mezzo. / Every part of this catalogue - photos included - is Euro-Fer's property. All forms of copying are strictly prohibited.



H.480 - Ø 550
Art. 01.136.05
Base 40 x 40



H.480 - Ø 550
Art. 01.136.06
Base 110 x 110



H.580 X L.1250 mm.

Art. 01.136.07 16 X 16 Liscio sinistro / *Smooth left*
Art. 01.136.09 16 X 16 Martellato sinistro / *Hammered left*

H.580 X L.1250 mm.

Art. 01.136.08 16 X 16 Liscio destro / *Smooth right*
Art. 01.136.10 16 X 16 Martellato destro / *Hammered right*



H.560 X L.1720 mm.

- Art. 01.136.11 □ 16 X 16 Liscio / Smooth
 Art. 01.136.12 □ 16 X 16 Martellato / Hammered

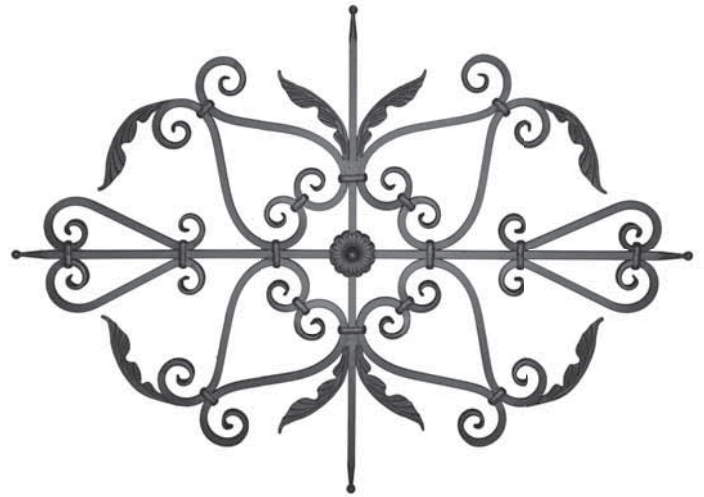

H.1420 X L.1030 mm.

- Art. 01.136.13 □ 16 X 16 Liscio / Smooth
 Art. 01.136.14 □ 16 X 16 Martellato / Hammered



H.1230 X L.1890 mm.

- Art. 01.136.15 □ 16 X 16 Liscio sinistro / Smooth left
 Art. 01.136.17 □ 16 X 16 Martellato sinistro / Hammered left



H.1230 X L.1890 mm.

- Art. 01.136.16 □ 16 X 16 Liscio destro / Smooth right
 Art. 01.136.18 □ 16 X 16 Martellato destro / Hammered right



Tutte le parti di questo catalogo - foto comprese - sono di proprietà Euro-Fer. La riproduzione, anche parziale, è vietata in ogni forma e con ogni mezzo. / Every part of this catalogue - photos included - is Euro-Fer's property. All forms of copying are strictly prohibited.



H.260 x L.100 mm
Liscio / Smooth

Art. 01.136.40 □ 14 X14mm

Art. 01.136.41 □ 12 X12mm

Martellato / Hammered

Art. 01.136.42 □ 14 X14mm

Art. 01.136.43 □ 12 X12mm



H.400 x L.110 mm
Liscio / Smooth

Art. 01.136.46 □ 14 X14mm

Art. 01.136.47 □ 12 X12mm

Martellato / Hammered

Art. 01.136.48 □ 14 X14mm

Art. 01.136.49 □ 12 X12mm



H.200 X L.95 mm.

Art. 01.137 □ 16 X 16



Martellato / Hammered

H.200 X L.95 mm.

Art. 01.138 □ 16 X 16



H.200 X L.95 mm.

Art. 01.139 □ 16 X 16



Martellato / Hammered

H.200 X L.95 mm.

Art. 01.140 □ 16 X 16



H.220 X L.115 mm.

Art. 01.141 □ 16 X 16



Martellato / Hammered

H.220 X L.115 mm.

Art. 01.142 □ 16 X 16



H.240 X L.160 mm.

Art. 01.143 □ 16 X 16



Martellato / Hammered

H.240 X L.160 mm.

Art. 01.144 □ 16 X 16



H.270 X L.100 mm.

Art. 01.145 □ 16 X 16



Martellato / Hammered

H.270 X L.100 mm.

Art. 01.146 □ 16 X 16



H.260 X L.135 mm.

Art. 01.147 □ 16 X 16



Martellato / Hammered

H.260 X L.135 mm.

Art. 01.148 □ 16 X 16



H.280 X L.105 mm.

Art. 01.149 □ 16 X 16



Martellato / Hammered

H.280 X L.105 mm.

Art. 01.150 □ 16 X 16



H.370 X L.190 mm.

Art. 01.151 □ 16 X 16



Martellato / Hammered

H.370 X L.190 mm.

Art. 01.152 □ 16 X 16



H.450 X L.200 mm.

Art. 01.153 □ 16 X 16



Martellato / Hammered

H.450 X L.200 mm.

Art. 01.154 □ 16 X 16



H.490 X L.170 mm.

Art. 01.155 □ 16 X 16



Martellato / Hammered

H.490 X L.170 mm.

Art. 01.156 □ 16 X 16



H.510 X L.195 mm.

Art. 01.157 □ 16 X 16



Martellato / Hammered

H.510 X L.195 mm.

Art. 01.158 □ 16 X 16



H.540 X L.200 mm.
Art. 01.159 □ 16 X 16



Martellato / Hammered
H.540 X L.200 mm.
Art. 01.160 □ 16 X 16



H.810 X L.540 mm.
Art. 01.161 □ 16 X 16



Martellato / Hammered
H.810 X L.540 mm.
Art. 01.162 □ 16 X 16



H.200 X L.85 mm.
Art. 01.163 □ 16 X 16



Martellato / Hammered
H.200 X L.85 mm.
Art. 01.164 □ 16 X 16



H.260 X L.95 mm.
Art. 01.165 □ 16 X 16



Martellato / Hammered
H.260 X L.95 mm.
Art. 01.166 □ 16 X 16



H.365 X L.170 mm.
Art. 01.167 □ 16 X 16



Martellato / Hammered
H.365 X L.170 mm.
Art. 01.168 □ 16 X 16



H.400 X L.185 mm.
Art. 01.169 □ 16 X 16



Martellato / Hammered
H.400 X L.185 mm.
Art. 01.170 □ 16 X 16



H.415 X L.190 mm.
Art. 01.171 □ 16 X 16



Martellato / Hammered
H.415 X L.190 mm.
Art. 01.172 □ 16 X 16



H.420 X L.150 mm.
Art. 01.173 □ 16 X 16



Martellato / Hammered
H.420 X L.150 mm.
Art. 01.174 □ 16 X 16



H.430 X L.205 mm.
Art. 01.175 □ 16 X 16



Martellato / Hammered
H.430 X L.205 mm.
Art. 01.176 □ 16 X 16



H.450 X L.180 mm.
Art. 01.177 □ 16 X 16



Martellato / Hammered
H.450 X L.180 mm.
Art. 01.178 □ 16 X 16



H.480 X L.140 mm.
Art. 01.179 □ 16 X 16



Martellato / Hammered
H.480 X L.140 mm.
Art. 01.180 □ 16 X 16



H.480 X L.160 mm.
Art. 01.181 □ 16 X 16



Martellato / Hammered
H.480 X L.160 mm.
Art. 01.182 □ 16 X 16

Tutte le parti di questo catalogo - foto comprese - sono di proprietà Euro-Fer. La riproduzione, anche parziale, è vietata in ogni forma e con ogni mezzo. / Every part of this catalogue - photos included - is Euro-Fer's property. All forms of copying are strictly prohibited.



H.520 X L.225 mm.
Art. 01.183 □ 16 X 16



Martellato / Hammered
H.520 X L.225 mm.
Art. 01.184 □ 16 X 16



H.550 X L.245 mm.
Art. 01.185 □ 16 X 16



Martellato / Hammered
H.550 X L.245 mm.
Art. 01.186 □ 16 X 16



H.590 X L.125 mm.
Art. 01.187 □ 16 X 16



Martellato / Hammered
H.590 X L.125 mm.
Art. 01.188 □ 16 X 16



H.600 X L.200 mm.
Art. 01.189 □ 16 X 16



Martellato / Hammered
H.600 X L.200 mm.
Art. 01.190 □ 16 X 16



H.600 X L.310 mm.
Art. 01.191 □ 16 X 16



Martellato / Hammered
H.600 X L.310 mm.
Art. 01.192 □ 16 X 16



H.620 X L.200 mm.
Art. 01.193 □ 16 X 16



Martellato / Hammered
H.620 X L.200 mm.
Art. 01.194 □ 16 X 16

Tutte le parti di questo catalogo - foto comprese - sono di proprietà Euro-Fer. La riproduzione, anche parziale, è vietata in ogni forma e con ogni mezzo. / Every part of this catalogue - photos included - is Euro-Fer's property. All forms of copying are strictly prohibited.



Martellato / Hammered

Martellato / Hammered

Martellato / Hammered

H.660 X L.170 mm.
Art. 01.195 □ 16 X 16

H.660 X L.170 mm.
Art. 01.196 □ 16 X 16

H.670 X L.200 mm.
Art. 01.197 □ 16 X 16

H.670 X L.200 mm.
Art. 01.198 □ 16 X 16

H.700 X L.330 mm.
Art. 01.199 □ 16 X 16

H.700 X L.330 mm.
Art. 01.200 □ 16 X 16



Martellato / Hammered

Martellato / Hammered

Martellato / Hammered

H.920 X L.310 mm.
Art. 01.201 □ 16 X 16

H.920 X L.310 mm.
Art. 01.202 □ 16 X 16

H.920 X L.530 mm.
Art. 01.203 □ 16 X 16

H.920 X L.530 mm.
Art. 01.204 □ 16 X 16

H.1020 X L.360 mm.
Art. 01.205 □ 16 X 16

H.1020 X L.360 mm.
Art. 01.206 □ 16 X 16



Tutte le parti di questo catalogo - foto comprese - sono di proprietà Euro-Fer. La riproduzione, anche parziale, è vietata in ogni forma e con ogni mezzo. / Every part of this catalogue - photos included - is Euro-Fer's property. All forms of copying are strictly prohibited.



H.170 X L.100 mm.
Art. 01.207 □ 16 X 16



Martellato / Hammered
H.170 X L.100 mm.
Art. 01.208 □ 16 X 16



H.210 X L.115 mm.
Art. 01.209 □ 16 X 16



Martellato / Hammered
H.210 X L.115 mm.
Art. 01.210 □ 16 X 16



H.220 X L.170 mm.
Art. 01.211 □ 16 X 16



Martellato / Hammered
H.220 X L.170 mm.
Art. 01.212 □ 16 X 16



H.250 X L.180 mm.
Art. 01.213 □ 16 X 16



Martellato / Hammered
H.250 X L.180 mm.
Art. 01.214 □ 16 X 16



H.270 X L.190 mm.
Art. 01.215 □ 16 X 16



Martellato / Hammered
H.270 X L.190 mm.
Art. 01.216 □ 16 X 16



H.280 X L.150 mm.
Art. 01.217 □ 16 X 16



Martellato / Hammered
H.280 X L.150 mm.
Art. 01.218 □ 16 X 16



H.310 X L.200 mm.
Art. 01.219 □ 16 X 16



Martellato / Hammered
H.310 X L.200 mm.
Art. 01.220 □ 16 X 16



H.320 X L.210 mm.
Art. 01.221 □ 16 X 16



Martellato / Hammered
H.320 X L.210 mm.
Art. 01.222 □ 16 X 16



H.320 X L.205 mm.
Art. 01.223 □ 16 X 16



H.320 X L.240 mm.
Art. 01.225 □ 16 X 16



Martellato / Hammered
H.320 X L.240 mm.
Art. 01.226 □ 16 X 16



H.350 X L.260 mm.
Art. 01.227 □ 16 X 16



Martellato / Hammered
H.350 X L.260 mm.
Art. 01.228 □ 16 X 16



H.350 X L.280 mm.
Art. 01.229 □ 16 X 16



Martellato / Hammered
H.350 X L.280 mm.
Art. 01.230 □ 16 X 16



H.420 X L.310 mm.
Art. 01.231 □ 16 X 16

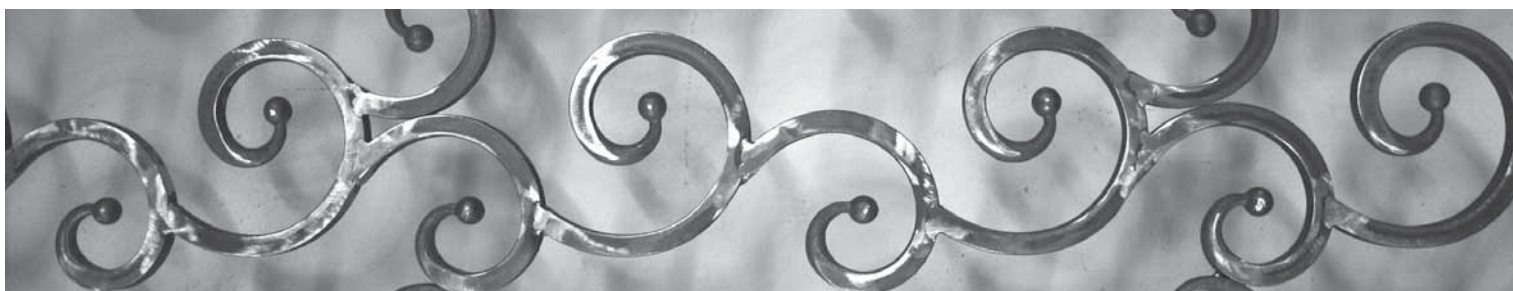

Tutte le parti di questo catalogo - foto comprese - sono di proprietà Euro-Fer. La riproduzione, anche parziale, è vietata in ogni forma e con ogni mezzo. / Every part of this catalogue - photos included - is Euro-Fer's property. All forms of copying are strictly prohibited.



H.450 X L.330 mm.
Art. 01.233 □ 16 X 16



Martellato / Hammered
H.450 X L.330 mm.
Art. 01.234 □ 16 X 16



H.480 X L.230 mm.
Art. 01.235 □ 16 X 16



Martellato / Hammered
H.480 X L.230 mm.
Art. 01.236 □ 16 X 16



H.510 X L.210 mm.
Art. 01.237 □ 16 X 16



Martellato / Hammered
H.510 X L.210 mm.
Art. 01.238 □ 16 X 16



H.540 X L.300 mm.
Art. 01.239 □ 16 X 16



Martellato / Hammered
H.540 X L.300 mm.
Art. 01.240 □ 16 X 16



H.580 X L.410 mm.
Art. 01.241 □ 16 X 16



Martellato / Hammered
H.580 X L.410 mm.
Art. 01.242 □ 16 X 16



H.200 X L.85 mm.
Art. 01.243 □ 10 X 10



H.240 X L.110 mm.
Art. 01.244 □ 10 X 10



H.250 X L.110 mm.
Art. 01.245 □ 10 X 10



H.270 X L.135 mm.
Art. 01.246 □ 10 X 10



H.350 X L.135 mm.
Art. 01.247 □ 10 X 10



H.420 X L.150 mm.
Art. 01.248 □ 10 X 10



H.470 X L.220 mm.
Art. 01.249 □ 10 X 10



H.450 X L.135 mm.
Art. 01.250 □ 10 X 10



H.330 X L.230 mm.
Art. 01.251 □ 10 X 10



H.440 X L.290 mm.
Art. 01.252 □ 10 X 10



H.540 X L.250 mm.
Art. 01.253 □ 10 X 10



H.570 X L.350 mm.
Art. 01.254 □ 10 X 10



Forgiato / Forged
H.360 X L.125 mm.
Art. 01.255 □ 14 X 14



Forgiato / Forged
H.360 X L.125 mm.
Art. 01.256 □ 14 X 14

Tutte le parti di questo catalogo - foto comprese - sono di proprietà Euro-Fer. La riproduzione, anche parziale, è vietata in ogni forma e con ogni mezzo. / Every part of this catalogue - photos included - is Euro-Fer's property. All forms of copying are strictly prohibited.



Tondo Forgiato / Round Forged
H.360 X L.125 mm.
Art. 01.257 Ø 14



Tondo / Round
H.360 X L.125 mm. Ø 12
Art. 01.258



Forgiato / Forged
H.360 X L.125 mm.
Art. 01.260 □ 14 X 14



Forgiato / Forged
H.360 X L.125 mm.
Art. 01.261 □ 14 X 14



Tondo Forgiato / Round Forged
H.360 X L.125 mm.
Art. 01.262 Ø 14



Tondo / Round
H.360 X L.125 mm. Ø 12
Art. 01.263



H.400 X L.200 mm.
Art. 01.265 □ 12 X 12
Art. 01.266 □ 14 X 14



Martellato / Hammered
H.400 X L.200 mm.
Art. 01.267 □ 12 X 12
Art. 01.268 □ 14 X 14



Forgiato / Forged
H.360 X L.125 mm.
Art. 01.269 □ 14 X 14



Forgiato / Forged
H.360 X L.125 mm.
Art. 01.270 □ 14 X 14



Tondo Forgiato / Round Forged
H.360 X L.125 mm.
Art. 01.271 Ø 14



Martellato / Hammered
H.360 X L.125 mm. □ 14 X 14
Art. 01.272
H.600 X L.125 mm. □ 14 X 14
Art. 01.273



Martellato / Hammered
H.360 X L.125 mm. □ 14 X 14
Art. 01.274
H.600 X L.125 mm. □ 14 X 14
Art. 01.275



Forgiato / Forged
H.360 X L.125 mm.
Art. 01.276 □ 14 X 14



Forgiato / Forged
H.360 X L.130 mm.
Art. 01.276.01 □ 14 X 14



Forgiato / Forged
H.360 X L.125 mm.
Art. 01.277 □ 14 X 14



Tondo Forgiato / Round Forged
H.360 X L.125 mm.
Art. 01.278 Ø 14



Martellato / *Hammered*
H.360 X L.125 mm.
Art. 01.279 □ 14 X 14

H.600 X L.125 mm.
Art. 01.280 □ 14 X 14



Martellato / *Hammered*
H.360 X L.125 mm.
Art. 01.281 □ 14 X 14

H.600 X L.125 mm.
Art. 01.282 □ 14 X 14



Martellato / *Hammered* □ 12 X 12
Art. 01.283 H.360 X L.125 mm.
Art. 01.284 H.600 X L.125 mm

Martellato / *Hammered* □ 14 X 14
Art. 01.285 H.360 X L.125 mm
Art. 01.286 H.600 X L.125 mm



□ 12 X 12
Art. 01.287 H.360 X L.125 mm.
Art. 01.288 H.600 X L.125 mm

□ 14 X 14
Art. 01.289 H.360 X L.125 mm
Art. 01.290 H.600 X L.125 mm



Martellato / *Hammered*
H.250 X L.150 mm.
Art. 01.291 □ 12 X 12
Art. 01.292 □ 14 X 14



Mod. Scala / *Scala Model*
H.115 X L.75 mm.
Art. 01.293 □ 8 X 8



Modello Scala / *Scala Model*
H.180 X L.90 mm.
Art. 01.294 ≧ 12 X 6
Art. 01.295 ≧ 14 X 6
Art. 01.295.01 ≧ 16 X 6



Modello Scala / *Scala Model*
H.280 X L.125 mm.
Art. 01.296 ≧ 12 X 6
Art. 01.297 ≧ 14 X 6
Art. 01.297.01 ≧ 16 X 6



Modello Scala / *Scala Model*
H.350 X L.135 mm.
Art. 01.298 ≧ 12 X 6
Art. 01.299 ≧ 14 X 6
Art. 01.299.01 ≧ 16 X 6



Modello Scala / *Scala Model*
H.450 X L.145 mm.
Art. 01.300 ≧ 12 X 6
Art. 01.301 ≧ 14 X 6
Art. 01.301.01 ≧ 16 X 6



H.280 X L.125 mm.
Art. 01.302 ≧ 12 X 6
Art. 01.303 ≧ 14 X 6
Art. 01.303.01 ≧ 16 X 6



H.350 X L.135 mm.
Art. 01.304 ≧ 12 X 6
Art. 01.305 ≧ 14 X 6
Art. 01.305.01 ≧ 16 X 6

Tutte le parti di questo catalogo - foto comprese - sono di proprietà Euro-Fer. La riproduzione, anche parziale, è vietata in ogni forma e con ogni mezzo. / Every part of this catalogue - photos included - is Euro-Fer's property. All forms of copying are strictly prohibited.



H.450 X L.145 mm.
 Art. 01.306 \neq 12 X 6
 Art. 01.307 \neq 14 X 6
 Art. 01.307.01 \neq 16 X 6



H.125 X L.80 mm.
 Art. 01.308 \neq 12 X 6
 Art. 01.309 \neq 14 X 6



H.145 X L.70 mm.
 Art. 01.310 \neq 12 X 6
 Art. 01.311 \neq 14 X 6



H.250 X L.130 mm.
 Art. 01.312 \neq 12 X 6
 Art. 01.313 \neq 14 X 6



Tondo / Round
 H.290 X L.115 mm.
 Art. 01.314 \varnothing 12
 Art. 01.314.01 \varnothing 14



Tondo / Round
 H.350 X L.125 mm.
 Art. 01.315 \varnothing 12
 Art. 01.315.01 \varnothing 14



Tondo / Round
 H.390 X L.130 mm.
 Art. 01.316 \varnothing 12
 Art. 01.316.01 \varnothing 14



Tondo / Round
 H.450 X L.130 mm.
 Art. 01.317 \varnothing 12
 Art. 01.317.01 \varnothing 14



Tondo / Round
 H.180 X L.105 mm.
 Art. 01.318 \varnothing 12
 Art. 01.318.01 \varnothing 14



Tondo / Round
 H.220 X L.110 mm.
 Art. 01.319 \varnothing 12
 Art. 01.319.01 \varnothing 14



Tondo / Round
 H.190 X L.105 mm.
 Art. 01.320 \varnothing 12
 Art. 01.320.01 \varnothing 14



Tondo / Round
 H.500 X L.100 mm.
 Art. 01.321 \varnothing 12
 Art. 01.321.01 \varnothing 14



Tondo Martellato
 Hammered Round
 H.290 X L.115 mm.
 Art. 01.322 \varnothing 12
 Art. 01.322.01 \varnothing 14



Tondo Martellato
 Hammered Round
 H.350 X L.125 mm.
 Art. 01.323 \varnothing 12
 Art. 01.323.01 \varnothing 14



Tondo Martellato
 Hammered Round
 H.390 X L.130 mm.
 Art. 01.324 \varnothing 12
 Art. 01.324.01 \varnothing 14



Tondo Martellato
 Hammered Round
 H.450 X L.130 mm.
 Art. 01.325 \varnothing 12
 Art. 01.325.01 \varnothing 14



Tondo Martellato
 Hammered Round
 H.180 X L.105 mm.
 Art. 01.326 \varnothing 12
 Art. 01.326.01 \varnothing 14



Tondo Martellato
 Hammered Round
 H.220 X L.110 mm.
 Art. 01.327 \varnothing 12
 Art. 01.327.01 \varnothing 14



Tondo Martellato
 Hammered Round
 H.190 X L.105 mm.
 Art. 01.328 \varnothing 12
 Art. 01.328.01 \varnothing 14



Tondo Martellato
 Hammered Round
 H.500 X L.100 mm.
 Art. 01.329 \varnothing 12



Martellato / Hammered
 H.380 X L.200 mm.
 Art. 01.330 \neq 25 X 6



Martellato / Hammered
 H.470 X L.270 mm.
 Art. 01.331 \neq 25 X 6



Martellato / Hammered
 H.640 X L.130 mm.
 Art. 01.332 \neq 25 X 6



Martellato / Hammered
 H.300 X L.150 mm.
 Art. 01.333 \neq 25 X 6



Martellato / *Hammered*
H.710 X L.305 mm.
Art. 01.334 ≙ 25 X 6



Martellato / *Hammered*
H.700 X L.300 mm.
Art. 01.335 ≙ 25 X 6



Martellato / *Hammered*
H.170 X L.115 mm.
Art. 01.336 □ 12 X 12
Art. 01.337 □ 14 X 14



Tondo / *Round*
H.200 X L.135 mm.
Art. 01.340 Ø 12
Art. 01.341 Ø 14
Art. 01.342 Ø 16



Liscio / *Smooth*
H.200 X L.135 mm.
Art. 01.343 □ 12 X 12
Art. 01.344 □ 14 X 14
Art. 01.345 □ 16 X 16



Martellato / *Hammered*
H.360 X L.130 mm.
Art. 01.349 □ 12 X 12
Art. 01.350 □ 14 X 14



Tondo / *Round*
H.350 X L.150 mm.
Art. 01.353 Ø 12
Art. 01.354 Ø 14
Art. 01.355 Ø 16



Liscio / *Smooth*
H.350 X L.150 mm.
Art. 01.356 □ 12 X 12
Art. 01.357 □ 14 X 14
Art. 01.358 □ 16 X 16



Liscio / *Smooth*
H.350 X L.150 mm.
Art. 01.362 □ 12 X 12
Art. 01.363 □ 14 X 14
Art. 01.364 □ 16 X 16



Tondo / *Round*
H.350 X L.150 mm.
Art. 01.368 Ø 12
Art. 01.369 Ø 14
Art. 01.370 Ø 16



Liscio / *Smooth*
H.135 X L.80 mm.
Art. 01.371 ≙ 14 X 6



Liscio / *Smooth*
H.360 X L.130 mm.
Art. 01.351 □ 12 X 12
Art. 01.352 □ 14 X 14

Liscio / *Smooth*
H.145 X L.90 mm.
Art. 01.372 Ø 10
Art. 01.372.01 Ø 12

Martellato / *Hammered*
H.350 X L.150 mm.
Art. 01.359 □ 12 X 12
Art. 01.360 □ 14 X 14
Art. 01.361 □ 16 X 16

Martellato / *Hammered*
H.350 X L.150 mm.
Art. 01.365 □ 12 X 12
Art. 01.366 □ 14 X 14
Art. 01.367 □ 16 X 16



Liscio / *Smooth*
H.290 X L.120 mm.
Art. 01.373 ≙ 14 X 6



Mod. Scala / *Scala model*
H.290 X L.120 mm.
Art. 01.374 ≙ 14 X 6



Liscio / *Smooth*
H.220 X L.110 mm.
Art. 01.375 ≙ 14 X 6



Liscio / *Smooth*
H.200 X L.100 mm.
Art. 01.376 ≙ 14 X 6
Art. 01.376.02 ≙ 16 X 8



Liscio / *Smooth*
H.250 X L.75 mm.
Art. 01.377 ≙ 14 X 6

Particolare con
rosetta / *Finished*
part with *little rose*



Liscio / *Smooth*
H.135 X L.80 mm.
Art. 01.400 ≙ 14 X 6



Tutte le parti di questo catalogo - foto comprese - sono di proprietà Euro-Fer. La riproduzione, anche parziale, è vietata in ogni forma e con ogni mezzo. / Every part of this catalogue - photos included - is Euro-Fer's property. All forms of copying are strictly prohibited.



Liscio / Smooth
H.190 X L.65 mm.
Art. 01.401 □ 8 X 8

Liscio / Smooth
H.200 X L.100 mm.
Art. 01.402 ≙ 14 X 6

Liscio / Smooth
H.220 X L.110 mm.
Art. 01.403 ≙ 14 X 6

Liscio / Smooth
H.360 X L.125 mm.
Art. 01.404 □ 12 X 12
Art. 01.404.01 □ 14 X 14
Art. 01.404.02 □ 16 X 16

Liscio / Smooth
H.350 X L.150 mm.
Art. 01.405 □ 12 X 12
Art. 01.405.01 □ 14 X 14
Art. 01.405.02 □ 16 X 16

Liscio / Smooth
H.350 X L.150 mm.
Art. 01.406 ∅ 12
Art. 01.406.01 ∅ 14



Particolare con rosetta / Finished part with little rose



Liscio / Smooth
H.420 X L.220 mm.
Art. 01.407 ∅ 10
Art. 01.407.01 ∅ 12
Art. 01.407.02 ∅ 14

Liscio / Smooth
H.550 X L.125 mm.
Art. 01.408 ∅ 10
Art. 01.408.01 ∅ 12
Art. 01.408.02 ∅ 14
Art. 01.408.03 ∅ 16

Liscio / Smooth
H.250 X L.75 mm.
Art. 01.409 ≙ 14 X 6

Rigato -Martellato-Attorcigliato
Fluted-Hammered and Twisted
H.800 X L.220 mm.
Art. 01.450 □ 14 X 14

Rigato -Martellato-Attorcigliato
Fluted-Hammered and Twisted
H.500 X L.145 mm.
Art. 01.451 □ 14 X 14

Rigato -Martellato-Attorcigliato
Fluted-Hammered and Twisted
H.330 X L.130 mm.
Art. 01.452 □ 14 X 14

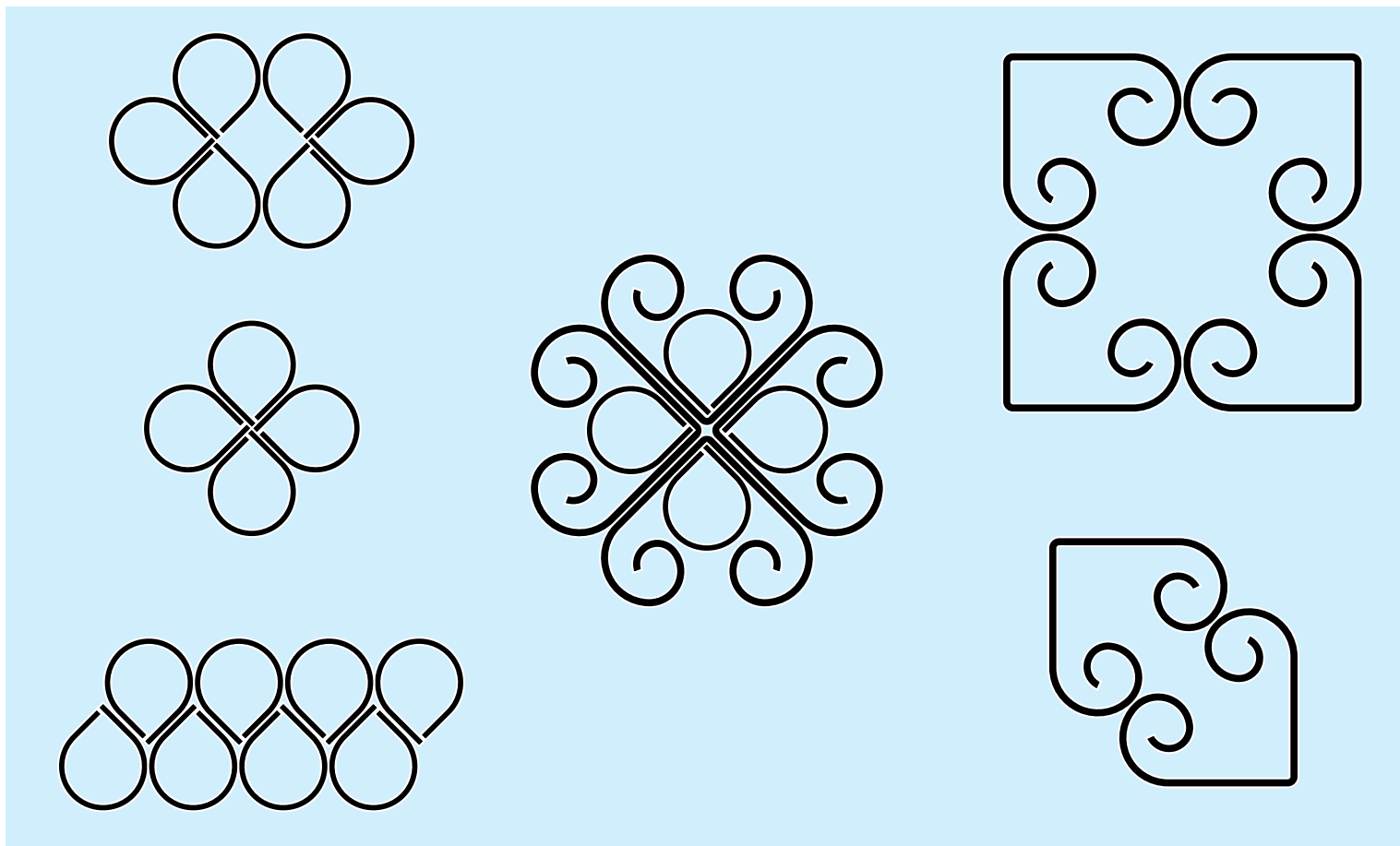



Finitura a caldo
Hot finished



Liscio / Smooth
H.200 x L.125 mm
Art. 01.490 \varnothing 14
Art. 01.491 \varnothing 16
Art. 01.492 \varnothing 18
Art. 01.493 \varnothing 20



Liscio / Smooth
H.160 x L.175 mm
Art. 01.500 \square 12X12
Art. 01.501 \neq 16x8
Art. 01.502 \neq 20x10
Art. 01.503 \varnothing 10



Liscio / Smooth
H.155 X L.95 mm.
Art. 01.504 \square 12 X 12
Art. 01.505 \neq 16 X 8
Art. 01.506 \neq 20 X 10
Art. 01.507 \varnothing 10



Liscio / Smooth
H.270 X L.85 mm.
Art. 01.508 \square 12 X 12
Art. 01.509 \neq 16 X 8
Art. 01.510 \neq 20 X 10
Art. 01.511 \varnothing 10



Liscio / Smooth
H.180 X L.90 mm.
Art. 01.512 \square 12 X 12
Art. 01.513 \neq 16 X 8
Art. 01.514 \neq 20 X 10
Art. 01.515 \varnothing 10



Liscio / Smooth
H.290 X L.115 mm.
Art. 01.516 \square 12 X 12
Art. 01.517 \neq 16 X 8
Art. 01.518 \neq 20 X 10
Art. 01.519 \varnothing 10



Liscio / Smooth
H.350 x L.110 mm
Art. 01.519.10 \square 16 X16



Liscio / Smooth
H.420 x L.165 mm
Art. 01.519.15 \square 16 X16



Liscio / Smooth
H.120 X L.70 mm.
Art. 01.520 \varnothing 10



Liscio / Smooth
H.140 X L.70 mm.
Art. 01.521 \varnothing 10



Liscio / Smooth
H.140 X L.80 mm.
Art. 01.522 \varnothing 10



Liscio / Smooth
H.210 x L.140 mm
Art. 01.522.05 \varnothing 10
Art. 01.522.06 \square 12
Art. 01.522.07 \neq 16 x 8
Art. 01.522.08 \neq 20 x 10



Liscio / Smooth
H.410 x L.270 mm
Art. 01.522.10 \varnothing 10
Art. 01.522.11 \square 12
Art. 01.522.12 \neq 20 x 10
Art. 01.522.13 \neq 16 x 8



Liscio / Smooth
H.294 X L.110 mm.
Art. 01.523 \neq 14 X 6
Art. 01.523.01 \neq 16 X 6



Mod. Scala / Scala Model
H.294 X L.110 mm.
Art. 01.524 \neq 14 X 6
Art. 01.524.01 \neq 16 X 6



Liscio / Smooth
H.200 x L.200 mm
Art. 01.525 \neq 12 x 6



Liscio / Smooth
H.120 x L.100 mm
Art. 01.526 \neq 12 x 6
H.125 x L.100 mm
Art. 01.527 \square 12



Liscio / Smooth
H.125 x L.117 mm
Art. 01.600 \neq 12 x 6

Fuori Produzione
Out of Production

Tutte le parti di questo catalogo - foto comprese - sono di proprietà Euro-Fer. La riproduzione, anche parziale, è vietata in ogni forma e con ogni mezzo. / Every part of this catalogue - photos included - is Euro-Fer's property. All forms of copying are strictly prohibited.

(N.B.: Tutti i cerchi non sono saldati.)
 (NOTE: All the circles are not welded.)
 H= Diametro esterno/ External Diameter

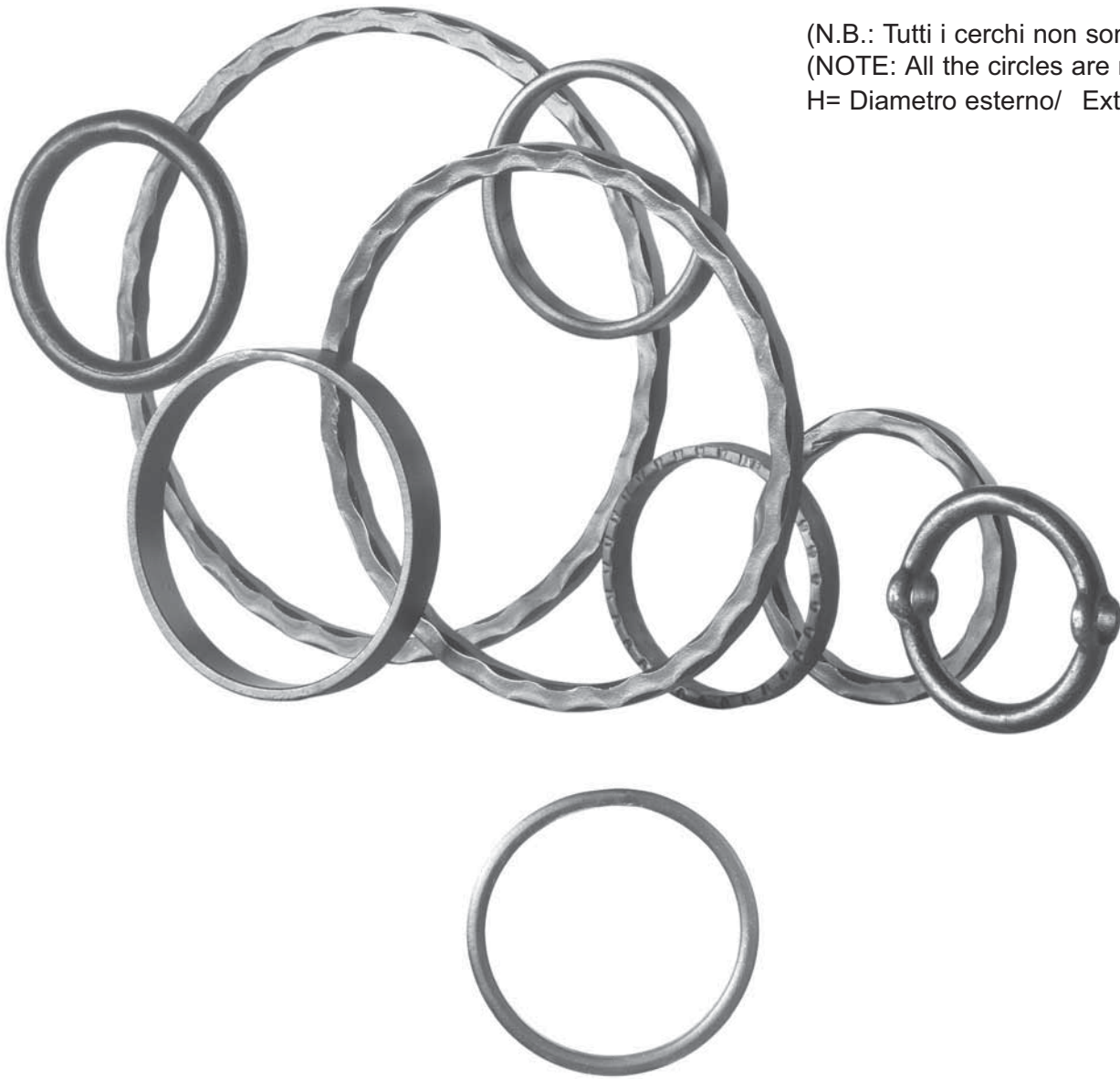

Cerchi con sezione in tondo e tondo martellato
 Round section circles and hammered circles

Ø 8 mm.	
Art. 02.001	H 100 mm.
Art. 02.002	H 120 mm.
Art. 02.003	H 130 mm.
Art. 02.003.01	H 90 mm.
Art. 02.003.02	H 105 mm.
Art. 02.003.03	H 110 mm.
Art. 02.003.04	H 135 mm.
Art. 02.003.05	H 180 mm.
Art. 02.003.06	H 250 mm.
Art. 02.003.07	H 270 mm.

Ø 10 mm.	
Art. 02.004	H 100 mm.
Art. 02.005	H 120 mm.
Art. 02.006	H 130 mm.
Art. 02.006.01	H 90 mm.
Art. 02.006.02	H 110 mm.
Art. 02.006.03	H 135 mm.
Art. 02.006.04	H 140 mm.
Art. 02.006.05	H 180 mm.
Art. 02.006.06	H 250 mm.
Art. 02.006.07	H 270 mm.

Ø 12 mm.	
Art. 02.006.50	H 115 mm.
Art. 02.007	H 100 mm.
Art. 02.008	H 120 mm.
Art. 02.009	H 130 mm.
Art. 02.009.01	H 110 mm.
Art. 02.009.02	H 135 mm.
Art. 02.009.03	H 140 mm.
Art. 02.009.04	H 180 mm.
Art. 02.009.05	H 210 mm.
Art. 02.009.06	H 250 mm.
Art. 02.009.07	H 275 mm.

Mart. a caldo / Hot hammered Ø 12 mm.	
Art. 02.007.01	H 100 mm.
Art. 02.007.02	H 110 mm.
Art. 02.007.03	H 120 mm.
Art. 02.007.04	H 130 mm.
Art. 02.007.05	H 135 mm.
Art. 02.007.06	H 140 mm.
Art. 02.007.07	H 180 mm.
Art. 02.007.08	H 210 mm.
Art. 02.007.09	H 250 mm.
Art. 02.007.10	H 275 mm.

Ø 14 mm.	
Art. 02.009.08	H 100 mm.
Art. 02.009.09	H 110 mm.
Art. 02.009.10	H 115 mm.
Art. 02.009.11	H 120 mm.
Art. 02.009.12	H 125 mm.
Art. 02.009.13	H 130 mm.
Art. 02.009.14	H 135 mm.
Art. 02.009.15	H 140 mm.
Art. 02.009.16	H 160 mm.
Art. 02.009.17	H 180 mm.
Art. 02.009.18	H 250 mm.

Mart. a caldo / Hot hammered Ø 14 mm.	
Art. 02.009.26	H 100 mm.
Art. 02.009.27	H 110 mm.
Art. 02.009.28	H 115 mm.
Art. 02.009.29	H 120 mm.
Art. 02.009.30	H 125 mm.
Art. 02.009.31	H 130 mm.
Art. 02.009.32	H 135 mm.
Art. 02.009.33	H 140 mm.
Art. 02.009.34	H 160 mm.
Art. 02.009.35	H 180 mm.
Art. 02.009.36	H 250 mm.

Ø 16 mm.	
Art. 02.009.19	H 100 mm.
Art. 02.009.20	H 110 mm.
Art. 02.009.21	H 120 mm.
Art. 02.009.22	H 135 mm.
Art. 02.009.23	H 140 mm.
Art. 02.009.24	H 180 mm.
Art. 02.009.25	H 250 mm.

Mart. a caldo / Hot hammered Ø 16 mm.	
Art. 02.009.37	H 100 mm.
Art. 02.009.38	H 110 mm.
Art. 02.009.39	H 120 mm.
Art. 02.009.40	H 135 mm.
Art. 02.009.41	H 140 mm.
Art. 02.009.42	H 180 mm.
Art. 02.009.43	H 250 mm.



Cerchi con sezione in quadro
Square section circles



□ 8 X 8 mm.	
Art. 02.010	H 100 mm.
Art. 02.011	H 120 mm.
Art. 02.012	H 130 mm.
Art. 02.012.01	H 90 mm.
Art. 02.012.02	H 105 mm.
Art. 02.012.03	H 110 mm.
Art. 02.012.04	H 135 mm.
Art. 02.012.05	H 180 mm.
Art. 02.012.06	H 250 mm.
Art. 02.012.07	H 270 mm.

□ 12 X 12 mm.	
Art. 02.016	H 100 mm.
Art. 02.017	H 120 mm.
Art. 02.018	H 130 mm.
Art. 02.018.01	H 110 mm.
Art. 02.018.02	H 135 mm.
Art. 02.018.03	H 140 mm.
Art. 02.018.04	H 180 mm.
Art. 02.018.05	H 210 mm.
Art. 02.018.06	H 250 mm.
Art. 02.018.07	H 275 mm.

□ 16 X 16 mm.	
Art. 02.018.19	H 100 mm.
Art. 02.018.20	H 110 mm.
Art. 02.018.21	H 120 mm.
Art. 02.018.22	H 135 mm.
Art. 02.018.23	H 140 mm.
Art. 02.018.24	H 180 mm.
Art. 02.018.25	H 250 mm.

□ 10 X 10 mm.	
Art. 02.013	H 100 mm.
Art. 02.014	H 120 mm.
Art. 02.015	H 130 mm.
Art. 02.015.01	H 90 mm.
Art. 02.015.02	H 110 mm.
Art. 02.015.03	H 135 mm.
Art. 02.015.04	H 140 mm.
Art. 02.015.05	H 180 mm.
Art. 02.015.06	H 250 mm.
Art. 02.015.07	H 270 mm.

□ 14 X 14 mm.	
Art. 02.018.08	H 100 mm.
Art. 02.018.09	H 110 mm.
Art. 02.018.10	H 115 mm.
Art. 02.018.11	H 120 mm.
Art. 02.018.12	H 125 mm.
Art. 02.018.13	H 130 mm.
Art. 02.018.14	H 135 mm.
Art. 02.018.15	H 140 mm.
Art. 02.018.16	H 160 mm.
Art. 02.018.17	H 180 mm.
Art. 02.018.18	H 250 mm.

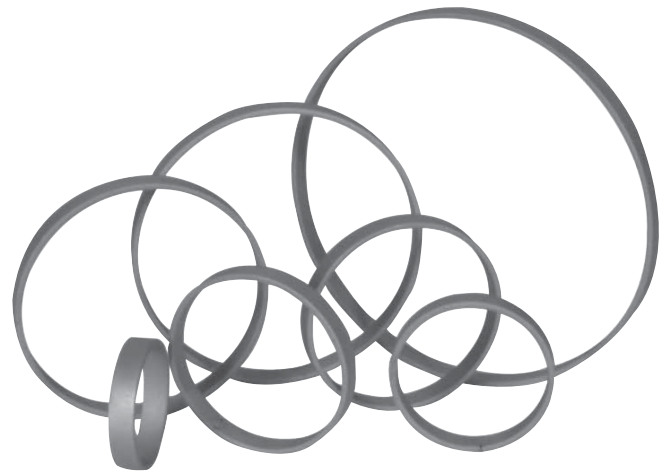

Cerchi con sezione in piatto
Flat section circles

≠ 16 X 4 mm.	
Art. 02.019	H 100 mm.
Art. 02.020	H 120 mm.
Art. 02.021	H 130 mm.
Art. 02.022	H 160 mm.
Art. 02.023	H 190 mm.
Art. 02.024	H 250 mm.
Art. 02.024.01	H 110 mm.
Art. 02.024.02	H 125 mm.
Art. 02.024.03	H 175 mm.
Art. 02.024.04	H 200 mm.
Art. 02.024.05	H 300 mm.

≠ 20 X 4 mm.	
Art. 02.025	H 100 mm.
Art. 02.026	H 120 mm.
Art. 02.027	H 130 mm.
Art. 02.028	H 160 mm.
Art. 02.029	H 190 mm.
Art. 02.030	H 250 mm.
Art. 02.030.01	H 110 mm.
Art. 02.030.02	H 125 mm.
Art. 02.030.03	H 175 mm.
Art. 02.030.04	H 200 mm.
Art. 02.030.05	H 300 mm.

≠ 30 X 4 mm.	
Art. 02.030.06	H 100 mm.
Art. 02.030.07	H 110 mm.
Art. 02.030.08	H 120 mm.
Art. 02.030.09	H 125 mm.
Art. 02.030.10	H 130 mm.
Art. 02.030.11	H 160 mm.
Art. 02.030.12	H 190 mm.
Art. 02.030.13	H 250 mm.

≠ 12 X 6 mm.	
Art. 02.031	H 100 mm.
Art. 02.032	H 120 mm.
Art. 02.033	H 130 mm.
Art. 02.034	H 160 mm.
Art. 02.035	H 190 mm.
Art. 02.035.01	H 80 mm.
Art. 02.035.02	H 90 mm.
Art. 02.035.03	H 105 mm.
Art. 02.035.04	H 110 mm.
Art. 02.035.05	H 115 mm.
Art. 02.035.06	H 125 mm.
Art. 02.035.07	H 128 mm.
Art. 02.035.08	H 150 mm.
Art. 02.035.09	H 250 mm.

≠ 14 X 6 mm.	
Art. 02.036	H 100 mm.
Art. 02.037	H 120 mm.
Art. 02.038	H 130 mm.
Art. 02.039	H 160 mm.
Art. 02.040	H 190 mm.
Art. 02.041	H 250 mm.
Art. 02.041.01	H 80 mm.
Art. 02.041.02	H 90 mm.
Art. 02.041.03	H 105 mm.
Art. 02.041.04	H 110 mm.
Art. 02.041.05	H 115 mm.
Art. 02.041.06	H 125 mm.
Art. 02.041.07	H 128 mm.
Art. 02.041.08	H 150 mm.

≠ 20 X 6 mm.	
Art. 02.041.09	H 80 mm.
Art. 02.041.10	H 90 mm.
Art. 02.041.11	H 100 mm.
Art. 02.041.12	H 105 mm.
Art. 02.041.13	H 110 mm.
Art. 02.041.14	H 115 mm.
Art. 02.041.15	H 120 mm.
Art. 02.041.16	H 125 mm.
Art. 02.041.17	H 128 mm.
Art. 02.041.18	H 130 mm.
Art. 02.041.19	H 150 mm.
Art. 02.041.20	H 160 mm.
Art. 02.041.21	H 190 mm.
Art. 02.041.22	H 250 mm.

≠ 16 X 8 mm.	
Art. 02.042	H 100 mm.
Art. 02.043	H 120 mm.
Art. 02.043.01	H 110 mm.
Art. 02.043.02	H 128 mm.
Art. 02.043.03	H 130 mm.
Art. 02.043.04	H 180 mm.

≠ 16 X 6 mm.	
Art. 02.043.29	H 80 mm.
Art. 02.043.30	H 90 mm.
Art. 02.043.31	H 100 mm.
Art. 02.043.32	H 105 mm.
Art. 02.043.33	H 110 mm.
Art. 02.043.34	H 115 mm.
Art. 02.043.35	H 120 mm.
Art. 02.043.36	H 125 mm.
Art. 02.043.37	H 128 mm.
Art. 02.043.38	H 130 mm.
Art. 02.043.39	H 150 mm.
Art. 02.043.40	H 160 mm.
Art. 02.043.41	H 190 mm.
Art. 02.043.42	H 250 mm.



Cerchio aperto sezione in piatto
Open circle flat section



Cerchio aperto sez. in quadro
Open circle square section

≠ 12 X 6 mm.	
Art. 02.043.05	H 100 mm.
Art. 02.043.06	H 110 mm.
Art. 02.043.07	H 120 mm.
Art. 02.043.08	H 130 mm.
Art. 02.043.09	H 150 mm.

≠ 20 X 6 mm.	
Art. 02.043.15	H 100 mm.
Art. 02.043.16	H 110 mm.
Art. 02.043.17	H 120 mm.
Art. 02.043.18	H 130 mm.
Art. 02.043.19	H 150 mm.

≠ 16 X 6 mm.	
Art. 02.043.43	H 100 mm.
Art. 02.043.44	H 110 mm.
Art. 02.043.45	H 120 mm.
Art. 02.043.46	H 130 mm.
Art. 02.043.47	H 150 mm.

□ 12 X 12 mm.	
Art. 02.043.24	H 100 mm.
Art. 02.043.25	H 110 mm.
Art. 02.043.26	H 120 mm.
Art. 02.043.27	H 130 mm.
Art. 02.043.28	H 180 mm.

≠ 14 X 6 mm.	
Art. 02.043.10	H 100 mm.
Art. 02.043.11	H 110 mm.
Art. 02.043.12	H 120 mm.
Art. 02.043.13	H 130 mm.
Art. 02.043.14	H 150 mm.

≠ 16 X 8 mm.	
Art. 02.043.20	H 100 mm.
Art. 02.043.21	H 110 mm.
Art. 02.043.22	H 120 mm.
Art. 02.043.23	H 130 mm.



Art. 02.043.100
H 100 mm ≠ 12 x 6 mm



H.200 X L.125 mm.
Art. 02.044 ≠ 12 X 6

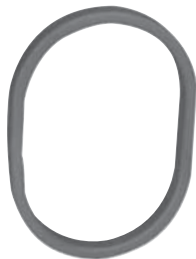

H.160 X L.120 mm.
Art. 02.048 ≠ 16 X 8



Ovale Piatto Modello Scala
Scala Model Flat Oval
H.160 X L.100 mm.
Art. 02.048.01 ≠ 12 X 6
Art. 02.048.02 ≠ 14 X 6
Art. 02.048.03 ≠ 16 X 6



H.240 X L.170 mm.
Art. 02.049 □ 14 X 14



H.160 X L.115 mm.
Art. 02.050 □ 12 X 12



H.100 X L.100 mm.
Art. 02.050.50 ≠ 14 x 6

H.160 X L.100 mm.	
Art. 02.045	≠ 16 X 8
Art. 02.045.01	≠ 12 X 6
Art. 02.045.02	≠ 14 X 6

H.140 X L.100 mm.	
Art. 02.046	≠ 16 X 8

H.190 X L.130 mm.	
Art. 02.047	≠ 20 X 4

H.200 X L.200 mm.	
Art. 02.051	□ 8 X 8
Art. 02.052	□ 10 X 10
Art. 02.053	□ 12 X 12



H.270 X L.190 mm.
Art. 02.054 □ 14 X 14



H.165 X L.120 mm.
Art. 02.055 □ 12 X 12



H.250 X L.175 mm.
Art. 02.056 □ 14 X 14



Mod. Scala / Scala Model
H.235 X L.125 mm.
Art. 02.057 ≠ 12 X 6
Art. 02.058 ≠ 14 X 6



H.250
Art. 02.059 ≠ 12 X 6
Art. 02.060 ≠ 14 X 6
Art. 02.061 ≠ 20 X 5



Mod. Scala / Scala Model
H.300 X L.110 mm.
Art. 02.062 ≠ 12 X 6
Art. 02.063 ≠ 14 X 6

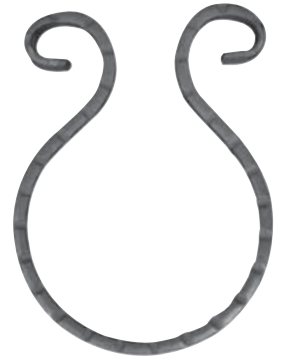

H.50 X L.50 mm.
 Art. 02.063.01 □ 4 X 4 - 6 Traf. / Elem.
 Art. 02.063.02 □ 4 X 4 - 4 Traf. / Elem.

H.70 X L.70 mm.
 Art. 02.063.03 □ 6 X 6 - 6 Traf. / Elem.
 Art. 02.063.04 □ 6 X 6 - 4 Traf. / Elem.

H.70 X L.70 mm.
 Art. 02.063.05 Ø 6 - 6 Traf. / Elem.

Mod. Scala / Scala Model
 H.160 X L.110 mm.
 Art. 02.064 ≙ 12 X 6
 Art. 02.065 ≙ 14 X 6



≙ 12 X 6 mm.
 Art. 02.065.01 H 100 mm.
 Art. 02.065.02 H 120 mm

≙ 12 X 6 mm.
 Art. 02.065.07 H 100 mm.
 Art. 02.065.08 H 120 mm

Ø 14 mm.
 Art. 02.065.13 H 110 mm.
 Art. 02.065.14 H 125 mm

Ø 14 mm.
 Art. 02.065.15 H 100 mm.
 Art. 02.065.16 H 110 mm.
 Art. 02.065.17 H 120 mm.

Mod. Scala / Scala Model
 H.160 X L.110 mm.
 Art. 02.064 ≙ 12 X 6
 Art. 02.065 ≙ 14 X 6

≙ 14 X 6 mm.
 Art. 02.065.03 H 100 mm.
 Art. 02.065.04 H 120 mm.

≙ 14 X 6 mm.
 Art. 02.065.09 H 100 mm.
 Art. 02.065.10 H 120 mm.

≙ 16 X 6 mm.
 Art. 02.065.05 H 100 mm.
 Art. 02.065.06 H 120 mm.

≙ 16 X 6 mm.
 Art. 02.065.11 H 100 mm.
 Art. 02.065.12 H 120 mm.



Piatto Modello Scala
 Flat Scala Model

Martellato
 Hammered

≙ 12 X 6 mm.
 Art. 02.072 H 100 mm.
 Art. 02.073 H 120 mm.
 Art. 02.074 H 130 mm.
 Art. 02.074.01 H 80 mm.
 Art. 02.074.02 H 90 mm.
 Art. 02.074.03 H 105 mm.
 Art. 02.074.04 H 110 mm.
 Art. 02.074.05 H 115 mm.
 Art. 02.074.06 H 125 mm.
 Art. 02.074.07 H 150 mm.
 Art. 02.074.08 H 250 mm.

≙ 20 X 6 mm.
 Art. 02.077.09 H 80 mm.
 Art. 02.077.10 H 90 mm.
 Art. 02.077.11 H 100 mm.
 Art. 02.077.12 H 105 mm.
 Art. 02.077.13 H 110 mm.
 Art. 02.077.14 H 115 mm.
 Art. 02.077.15 H 120 mm.
 Art. 02.077.16 H 125 mm.
 Art. 02.077.17 H 130 mm.
 Art. 02.077.18 H 150 mm.
 Art. 02.077.19 H 160 mm.
 Art. 02.077.20 H 190 mm.
 Art. 02.077.21 H 250 mm.

≙ 14 X 6 mm.
 Art. 02.075 H 100 mm.
 Art. 02.076 H 120 mm.
 Art. 02.077 H 130 mm.
 Art. 02.077.01 H 80 mm.
 Art. 02.077.02 H 90 mm.
 Art. 02.077.03 H 105 mm.
 Art. 02.077.04 H 110 mm.
 Art. 02.077.05 H 115 mm.
 Art. 02.077.06 H 125 mm.
 Art. 02.077.07 H 150 mm.
 Art. 02.077.08 H 250 mm.

≙ 16 X 6 mm.
 Art. 02.074.17 H.100
 Art. 02.074.18 H.110
 Art. 02.074.20 H.120

□ 12 X 12 mm.
 Art. 02.077.22 H 100 mm.
 Art. 02.077.23 H 110 mm.
 Art. 02.077.24 H 120 mm.
 Art. 02.077.25 H 180 mm.

Mart. a caldo / Hot hammered
 □ 14 X 14 mm.
 Art. 02.077.26 H 100 mm.
 Art. 02.077.27 H 110 mm.
 Art. 02.077.28 H 115 mm.
 Art. 02.077.29 H 120 mm.
 Art. 02.077.30 H 125 mm.
 Art. 02.077.31 H 130 mm.
 Art. 02.077.32 H 135 mm.
 Art. 02.077.33 H 140 mm.
 Art. 02.077.34 H 160 mm.
 Art. 02.077.35 H 180 mm.
 Art. 02.077.36 H 250 mm.

Mart. a caldo / Hot hammered
 □ 16 X 16 mm.
 Art. 02.077.37 H 100 mm.
 Art. 02.077.38 H 110 mm.
 Art. 02.077.39 H 120 mm.
 Art. 02.077.40 H 135 mm.
 Art. 02.077.41 H 140 mm.
 Art. 02.077.42 H 180 mm.
 Art. 02.077.43 H 250 mm.

Pigne a 4 Trafilati / 4 - Element Crowns



H.90 X L.35 mm.
Art. 02.078 □ 8 X 8



H.110 X L.45 mm.
Art. 02.079 □ 10 X 10



H.150 X L.65 mm.
Art. 02.080 □ 12 X 12



Liscio / Smooth
4 Trafilati / Elements
Art. 02.080.ES
H. 125 x L.57 mm □ 12 x 12
Art. 02.081.ES
H. 135 x L.60 mm □ 14 x 14
Art. 02.082.ES
H. 150 x L.70 mm □ 16 x 16



H.160 X L.70 mm.
Art. 02.081 □ 14 X 14



H.160 X L.70 mm.
Art. 02.082 □ 16 X 16



H.210 X L.90 mm.
Art. 02.083 □ 20 X 20



H.210 X L.110 mm.
Art. 02.084 □ 24 X 24
Martellato / Hammered
Art. 02.084.01 □ 24 X 24



H.240 X L.115 mm.
Art. 02.085 □ 30 X 30



4 Quadri da 6 mm
4 Six mm Squares



H.150 X L.50 mm.
Art. 02.089 □ 12 X 12



4 Tondini da 6 mm
4 Six mm Rounds

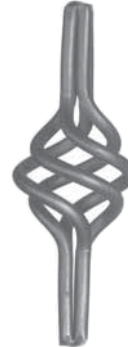

H.150 X L.50 mm.
Art. 02.090 Ø 12



4 Tondini da 6 mm
4 Six mm Rounds



H.150 X L.60 mm.
Art. 02.091 Ø 12



Art. 02.100 H.195 X L.50 mm. □ 12 X 12
Art. 02.100.01 H.200 X L.60 mm. □ 14 X 14
Art. 02.100.02 H.200 X L.65 mm. □ 16 X 16
Art. 02.100.03 H.195 X L.50 mm. Ø 12
A 9 trafilati / 9 - Element Crowns
Art. 02.100.04 H.195 X L.50 mm. □ 12 X 12

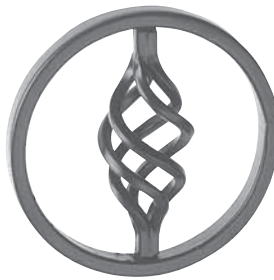

H.100 X L.100 mm.
Art. 02.130
≠ 14 X 6
□ 4 X 4



H.160 X L.105 mm.
Art. 02.140
≠ 14 X 6
□ 6 X 6

Pigne a 9 Trafilati / 9 - Element Crowns

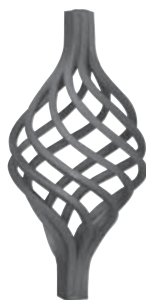

H.155 X L.75 mm.
Art. 02.086 □ 12 X 12

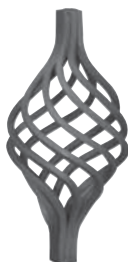

H.125 X L.65 mm.
Art. 02.086.01 □ 12 X 12



H.190 X L.105 mm.
Art. 02.087 □ 24 X 24

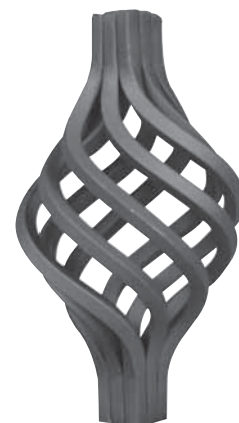

H.245 X L.130 mm.
Art. 02.088 □ 30 X 30



Liscio / Smooth
H. 190 x L.120 mm
Art. 02.200 □ 16 mm
Art. 02.200.01 □ 20 mm



Liscio / Smooth
H. 380 x L.120 mm
Art. 02.201 □ 16 mm



Liscio / Smooth
H. 235 x L.120 mm
Art. 02.202 □ 16 mm



Liscio / Smooth
H. 155 x L.135 mm
Art. 02.203 □ 16 mm
Art. 02.203.01 □ 20 mm



Liscio / Smooth
H. 470 x L.120 mm
Art. 02.204 □ 16 mm



Liscio / Smooth
H. 185 x L.155 mm
Art. 02.205 □ 16 mm



Liscio / Smooth
H. 195 x L.165 mm
Art. 02.206 □ 16 mm

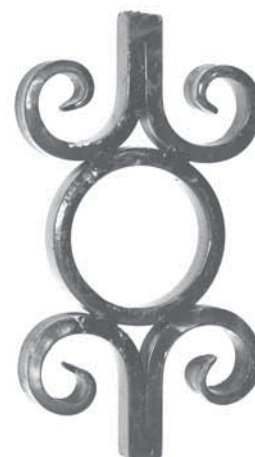

Liscio / Smooth
H. 240 x L.135 mm
Art. 02.207 □ 16 mm

Tutte le parti di questo catalogo - foto comprese - sono di proprietà Euro-Fer. La riproduzione, anche parziale, è vietata in ogni forma e con ogni mezzo. / Every part of this catalogue - photos included - is Euro-Fer's property. All forms of copying are strictly prohibited.

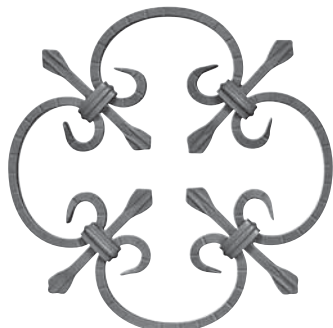

H.250 x L.250 mm
Modello Scala / Scala Model
Art. 03.001 □ 8 x 8
Liscio / Smooth
Art. 03.001.01 □ 8 x 8

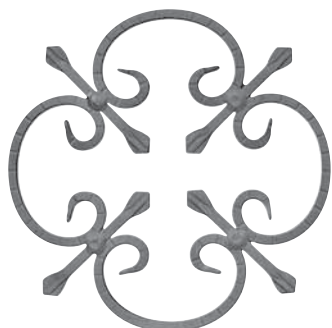

H.250 x L.250 mm
Modello Scala / Scala Model
Art. 03.002 □ 8 x 8
Liscio / Smooth
Art. 03.002.01 □ 8 x 8

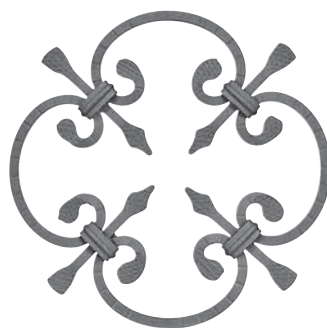

Mod. Scala / Scala Model
H.250 X L.250 mm.
Art. 03.003 □ 8 X 8



Mod. Scala / Scala Model
H.250 X L.250 mm.
Art. 03.004 □ 8 X 8

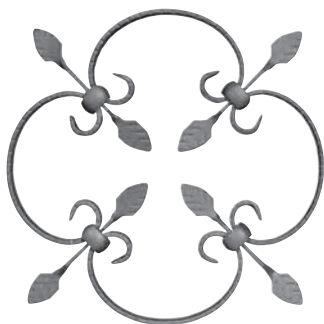

Mod. Scala / Scala Model
H.250 X L.250 mm.
Art. 03.005 ≧ 20 X 4

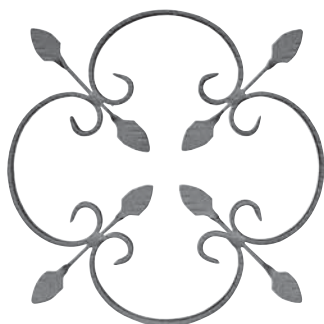

Mod. Scala / Scala Model
H.250 X L.250 mm.
Art. 03.006 ≧ 20 X 4

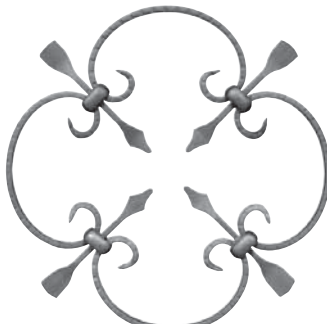

Mod. Scala / Scala Model
H.250 X L.250 mm.
Art. 03.007 ≧ 10 X 5

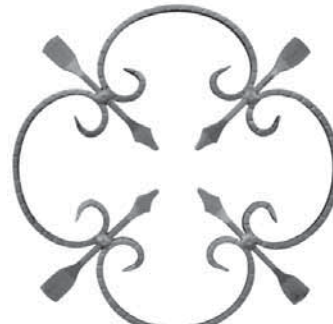

Mod. Scala / Scala Model
H.250 X L.250 mm.
Art. 03.008 ≧ 10 X 5

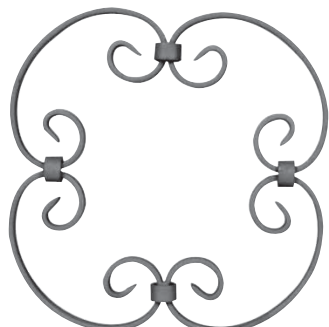

Liscio / Smooth
H.250 X L.250 mm.
Art. 03.009 ≧ 16 X 4

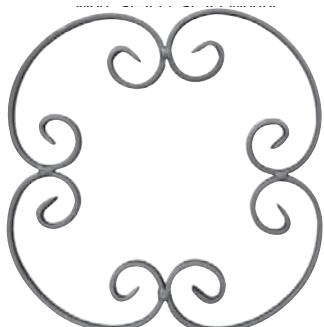

Liscio / Smooth
H.250 X L.250 mm.
Art. 03.010 ≧ 16 X 4

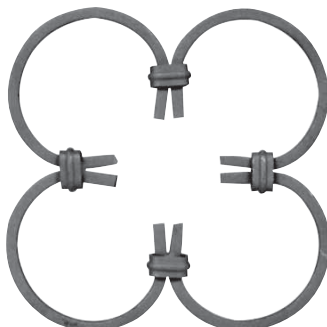

Liscio / Smooth
H.250 X L.250 mm.
Art. 03.011 □ 8 X 8

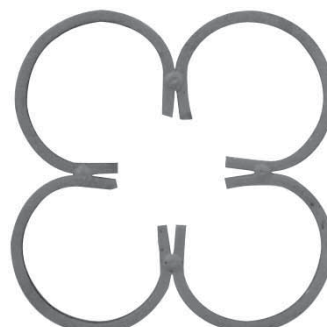

Liscio / Smooth
H.250 X L.250 mm.
Art. 03.012 □ 8 X 8

Tutte le parti di questo catalogo - foto comprese - sono di proprietà Euro-Fer. La riproduzione, anche parziale, è vietata in ogni forma e con ogni mezzo. / Every part of this catalogue - photos included - is Euro-Fer's property. All forms of copying are strictly prohibited.



H.250 X L.250 mm.
Art. 03.013 □ 8 X 8

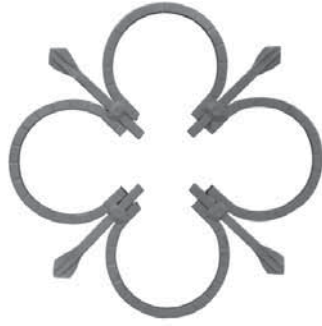

Mod. Scala / Scala Model
H.250 X L.250 mm.
Art. 03.014 □ 8 X 8



Liscio / Smooth
H.250 x L.250 mm
Art. 03.014.01 □ 8
Art. 03.014.02 Ø 8



Liscio / Smooth
H.250 x L.250 mm
Art. 03.014.03 ≡ 12 x 4



Liscio / Smooth
H.250 x L.250 mm
Art. 03.014.04 ≡ 12 x 4

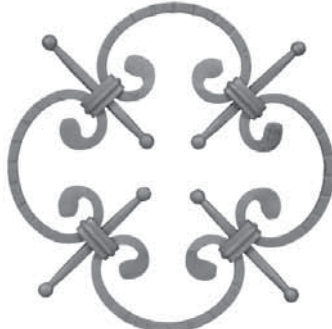

Mod. Scala / Scala Model
H.250 X L.250 mm.
Art. 03.015 □ 8 X 8



Mod. Scala / Scala Model
H.250 X L.250 mm.
Art. 03.016 □ 8 X 8

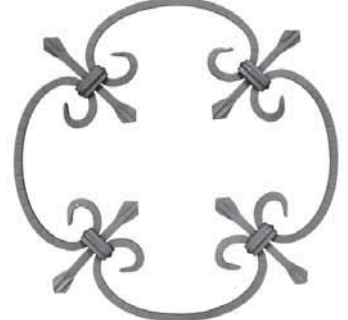

Mod. Scala / Scala Model
H.300 X L.300 mm.
Art. 03.017 □ 8 X 8

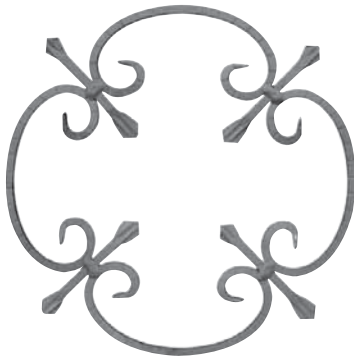

Mod. Scala / Scala Model
H.300 X L.300 mm.
Art. 03.018 □ 8 X 8



Liscio / Smooth
H.250 X L.250 mm.
Art. 03.018.01 ≡ 12 X 6

Mod. Scala / Scala Model
H.250 X L.250 mm.
Art. 03.018.02 ≡ 12 X 6

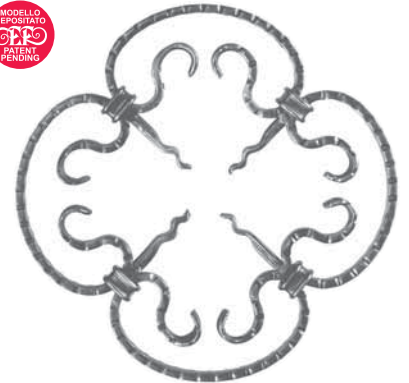

Mod. Scala / Scala Model
H.270 X L.270 mm.
Art. 03.018.03 ≡ 14 X 6



Tondo / Round
H.380 X L.380 mm.
Art. 03.018.04 Ø 12

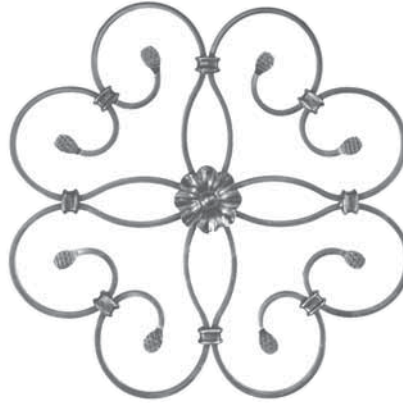

Liscio / Smooth
H.360 X L.360 mm.
Art. 03.018.05 ≡ 12 X 6
Art. 03.018.16 ≡ 14 X 6

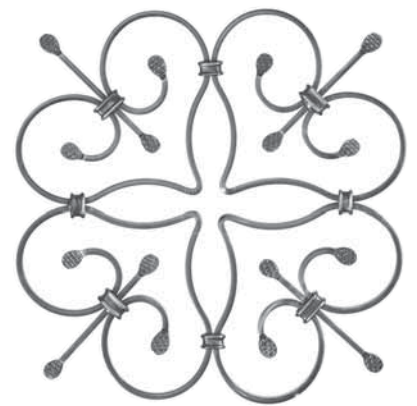

Liscio / Smooth
H.370 X L.370 mm.
Art. 03.018.06 ≡ 12 X 6
Art. 03.018.17 ≡ 14 X 6

Tutte le parti di questo catalogo - foto comprese - sono di proprietà Euro-Fer. La riproduzione, anche parziale, è vietata in ogni forma e con ogni mezzo. / Every part of this catalogue - photos included - is Euro-Fer's property. All forms of copying are strictly prohibited.



Mod. Scala / Scala Model

H.445 X L.445 mm.

Art. 03.018.07 ≙ 14 X 6

Art. 03.018.18 ≙ 16 X 6

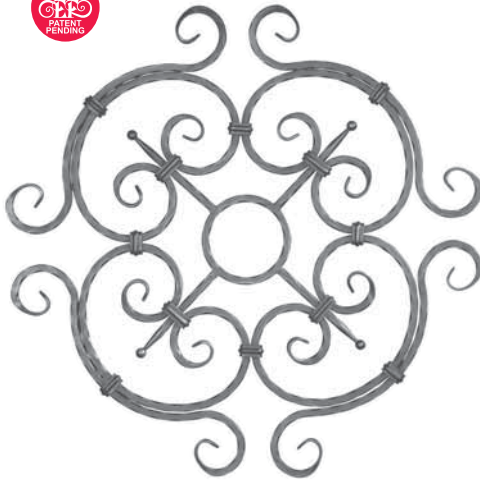

Martellato / Hammered

H.710 X L.710 mm.

Art. 03.018.08 □ 12 X 12



Modello Scala / Scala Model

H.760 x L.760 mm.

Art. 03.018.09 ≙ 14 x 6

Art. 03.018.19 ≙ 16 x 6



Martellato / Hammered

H.780 X L.780 mm.

Art. 03.018.10 □ 12 X 12

Art. 03.018.11 □ 14 X 14

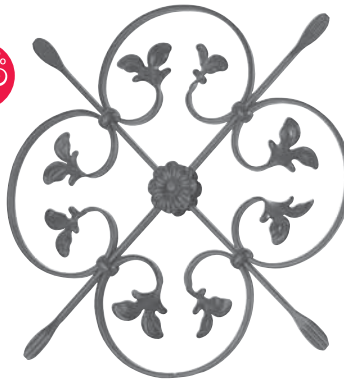

Liscio / Smooth

H.545 X L.545 mm.

Art. 03.018.12 ≙ 12 X 6

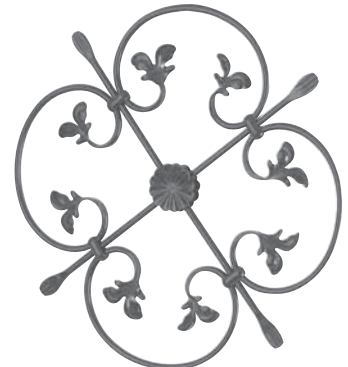

Liscio / Smooth

H.530 X L.530 mm.

Art. 03.018.13 Ø 10

Art. 03.018.20 Ø 12



Liscio / Smooth

H.545 X L.545 mm.

Art. 03.018.14

≙ 12 X 6

Ø 10

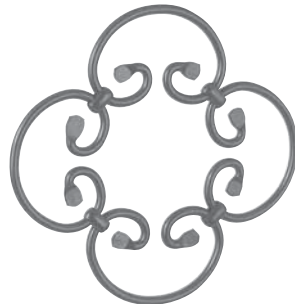

Liscio / Smooth

H.250 X L.250 mm.

Art. 03.018.15 Ø 8

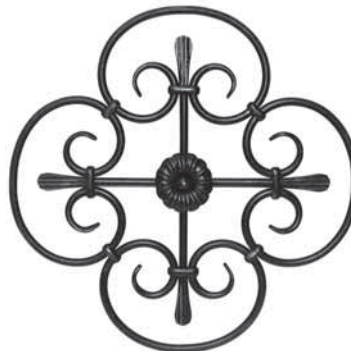

Liscio / Smooth

H.565 x L.565 mm

Art. 03.018.21 Ø 14 mm

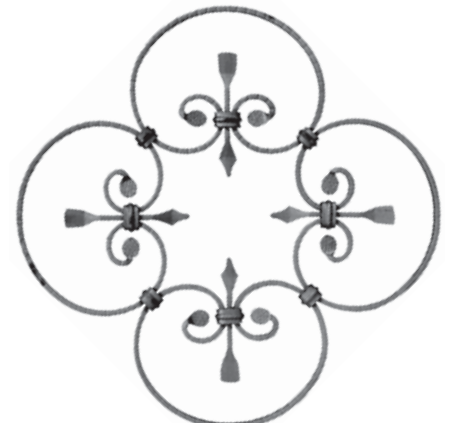

Mod. Scala / Scala Model

H.380 X L.380 mm.

Art. 03.019 ≙ 10 X 5

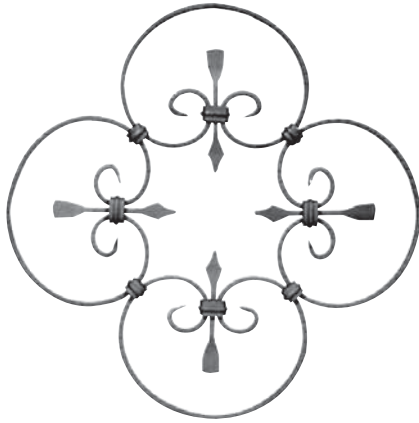

Mod. Scala / Scala Model
H.380 X L.380 mm.
Art. 03.020 ≙ 10 X 5

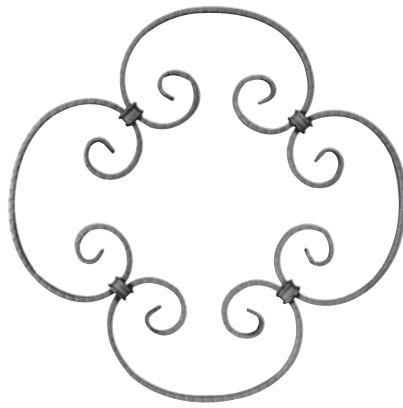

Mod. Scala / Scala Model
H.370 X L.370 mm.
Art. 03.021 ≙ 12 X 6

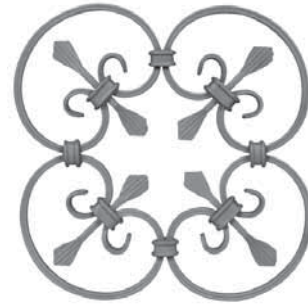

Rigato / Fluted
H.300 X L.300 mm.
Art. 03.022 ≙ 12 X 6



Rigato / Fluted
H.140 X L.205 mm.
Art. 03.023 ≙ 12 X 6



Mod. Scala / Scala Model
H.155 X L.155 mm.
Art. 03.024 □ 6 X 6

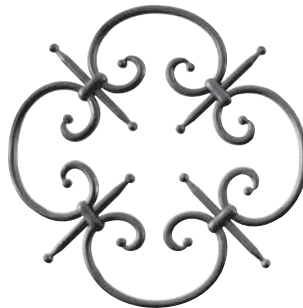

Liscio / Smooth
H.330 X L.330 mm.
Art. 03.024.01 ∅ 10

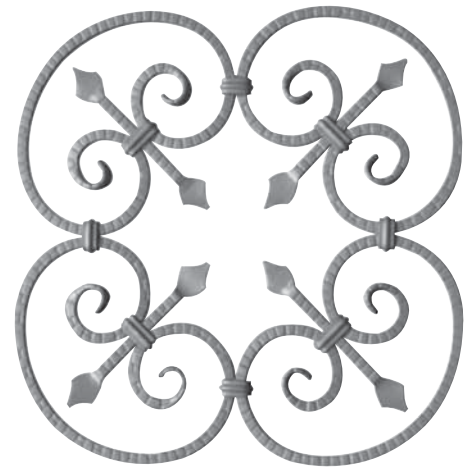

Mod. Mattone / Brick Model
H.590 X L.590 mm.
Art. 03.025 □ 12 X 12
Art. 03.025.02 □ 14 X 14

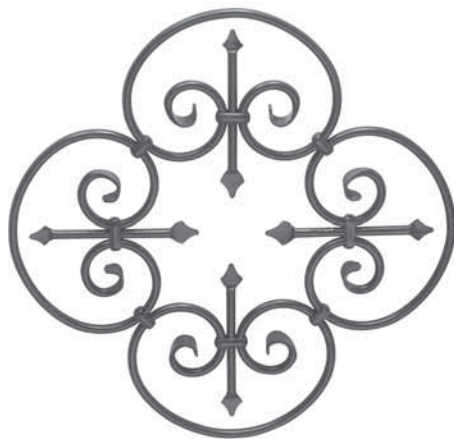

Liscio / Smooth
H.580 X L.580 mm.
Art. 03.025.01 ∅ 12
Art. 03.025.03 ∅ 14

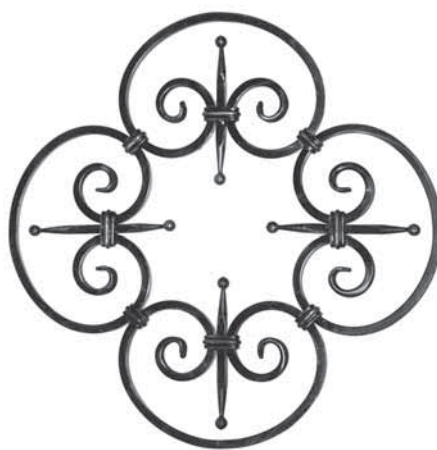

Liscio / Smooth
H.580 x L.580 mm
Art. 03.025.04 □ 12 mm
Art. 03.025.05 □ 14 mm

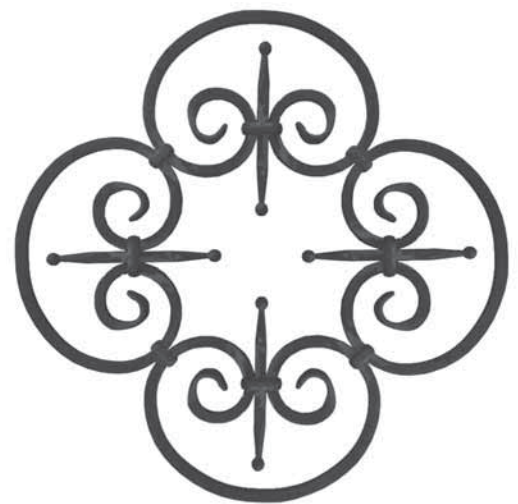

Liscio / Smooth
H.625 x L. 625
Art. 03.025.10 □ 14x14 mm

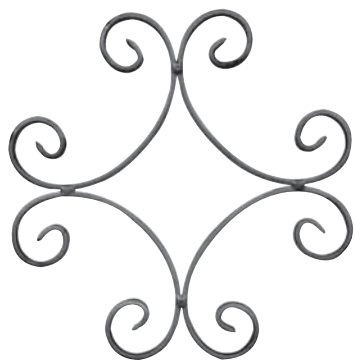

Liscio / Smooth
H.240 X L.240 mm.
Art. 03.026 ≙ 16 X 4

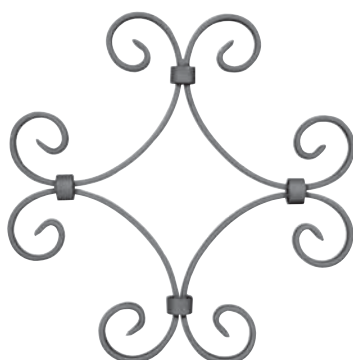

Liscio / Smooth
H.240 X L.240 mm.
Art. 03.027 ≙ 16 X 4

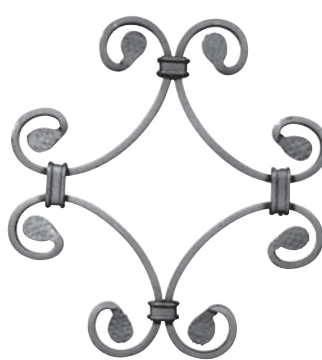

Liscio / Smooth
H.240 X L.240 mm.
Art. 03.028 ≙ 12 X 6

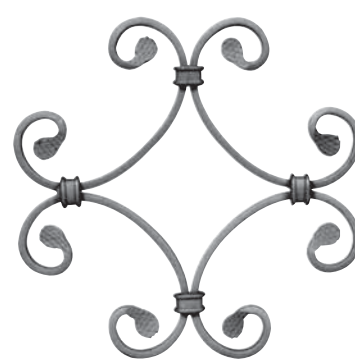

Liscio / Smooth
H.240 X L.240 mm.
Art. 03.029 ≙ 12 X 6

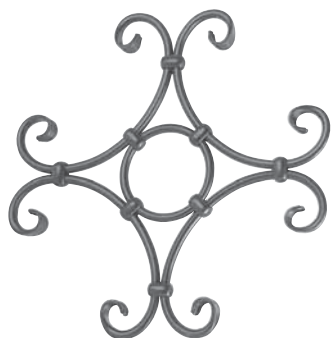

Liscio / Smooth
H.360 X L.360 mm.
Art. 03.029.01 Ø 10
Art. 03.029.03 Ø 12
Art. 03.029.04 Ø 14

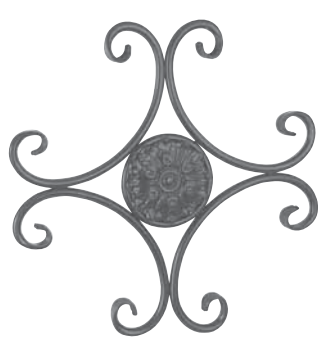

Liscio / Smooth
H.360 X L.360 mm.
Art. 03.029.02 Ø 10
Art. 03.029.05 Ø 12
Art. 03.029.06 Ø 14

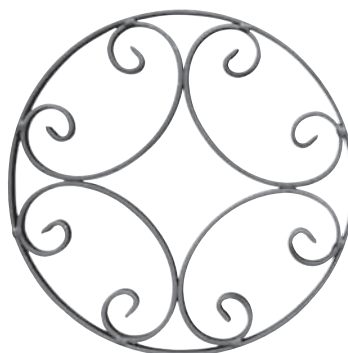

Liscio / Smooth
H.250 X L.250 mm.
Art. 03.030 ≙ 16 X 4

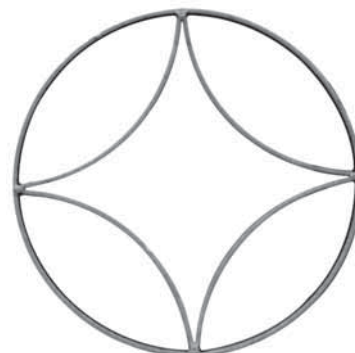

Liscio / Smooth
H.250 X L.250 mm.
Art. 03.031 ≙ 16 X 4



Mod. Scala / Scala Model
H.270 X L.270 mm.
Art. 03.031.01 ≙ 12 X 6
Art. 03.031.07 ≙ 14 X 6



Liscio / Smooth
H.220 X L.220 mm.
Art. 03.031.02 ≙ 12 X 6
Art. 03.031.08 ≙ 14 X 6

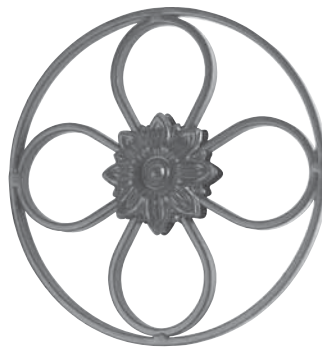

Liscio / Smooth
H.250 X L.250 mm.
Art. 03.031.03 ≙ 12 X 6
Art. 03.031.09 ≙ 14 X 6



Liscio / Smooth
H.250 X L.250 mm.
Art. 03.031.04 ≙ 12 X 6



Liscio / Smooth
H.250 X L.250 mm.
Art. 03.031.05 Ø 10



Liscio / Smooth
H.250 X L.250 mm.
Art. 03.031.06 Ø 10

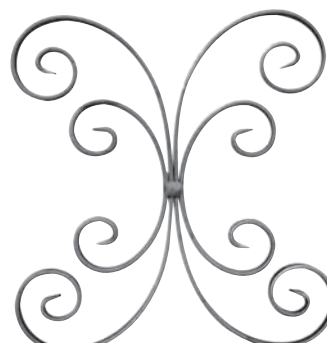

Liscio / Smooth
H.250 X L.250 mm.
Art. 03.032 ≙ 16 X 4

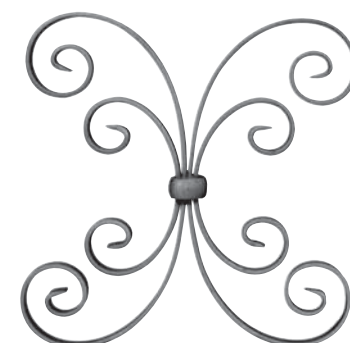

Liscio / Smooth
H.250 X L.250 mm.
Art. 03.033 ≙ 16 X 4

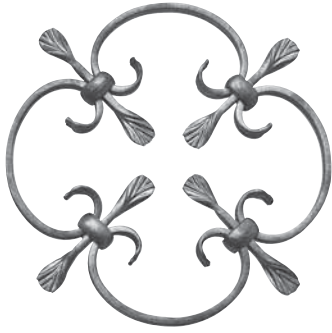

Liscio / Smooth
 H.350 X L.350 mm.
 Art. 03.033.01 ≙ 12 X 6
 H.250 X L.250 mm.
 Art. 03.033.02 ≙ 12 X 6

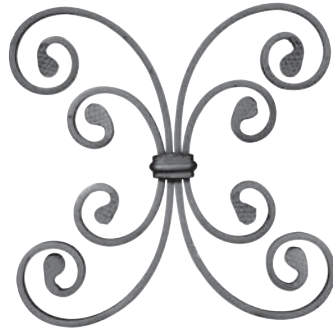

Liscio / Smooth
 H.250 X L.250 mm.
 Art. 03.034 ≙ 12 X 6



Liscio / Smooth
 H.260 X L.260 mm.
 Art. 03.034.01 ≙ 12 X 6

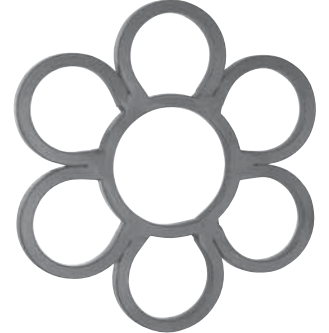

Liscio / Smooth
 H.300 X L.300 mm.
 Art. 03.034.10 □ 12 X 12

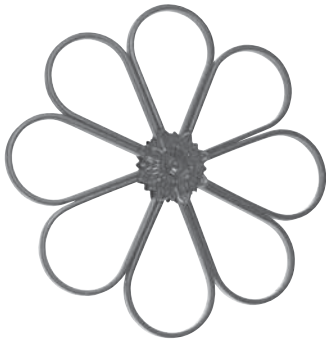

Liscio / Smooth
 H.380 X L.380 mm.
 Art. 03.034.12 ≙ 12 X 6



Liscio / Smooth
 H.530 X L.530 mm.
 Art. 03.034.21 ≙ 12 X 6



Liscio / Smooth
 H.470 X L.470 mm.
 Art. 03.034.22 Ø 10
 Art. 03.034.29 Ø 12
 Art. 03.034.30 Ø 14
 Art. 03.034.31 Ø 16

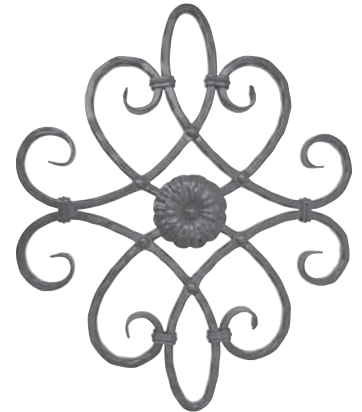

Martellato / Hammered
 H.520 X L.420 mm.
 Art. 03.034.23 □ 12 X 12
 Art. 03.034.32 □ 14 X 14
 Liscio / Smooth
 H.520 x L.420 mm
 Art. 03.034.41 □ 12 X 12
 Art. 03.034.42 Ø 12
 Art. 03.034.43 Ø 14

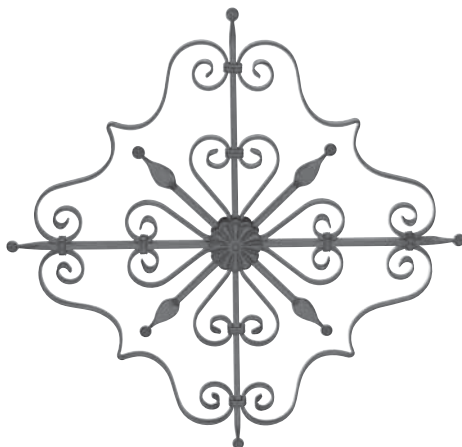

Liscio / Smooth
 H.830 X L.830 mm.
 Art. 03.034.24
 ≙ 12 X 6
 □ 12 X 12
 Art. 03.034.33
 ≙ 14 X 6
 □ 14 X 14

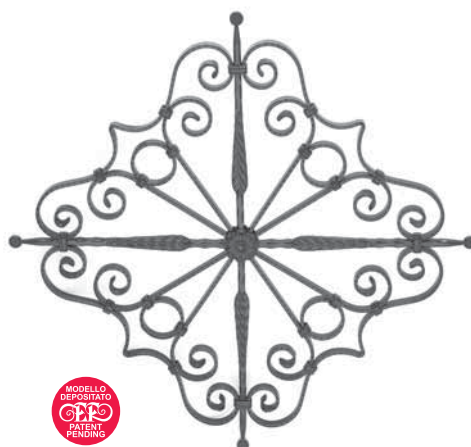

Liscio / Smooth
 H.830 X L.830 mm.
 Art. 03.034.25
 ≙ 12 X 6 Mod. Scala / Scala Model
 □ 12 X 12 Martellato / Hammered
 Art. 03.034.34
 ≙ 14 X 6 Mod. Scala / Scala Model
 □ 14 X 14 Martellato / Hammered

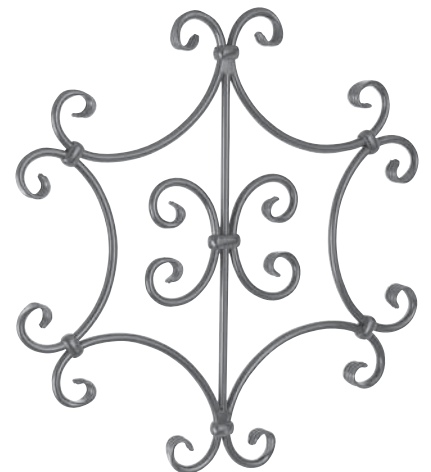

Liscio / Smooth
 H.500 X L.500 mm.
 Art. 03.034.26 Ø 12
 Art. 03.034.27 Ø 14
 Art. 03.034.28 Ø 16

Tutte le parti di questo catalogo - foto comprese - sono di proprietà Euro-Fer. La riproduzione, anche parziale, è vietata in ogni forma e con ogni mezzo. / Every part of this catalogue - photos included - is Euro-Fer's property. All forms of copying are strictly prohibited.

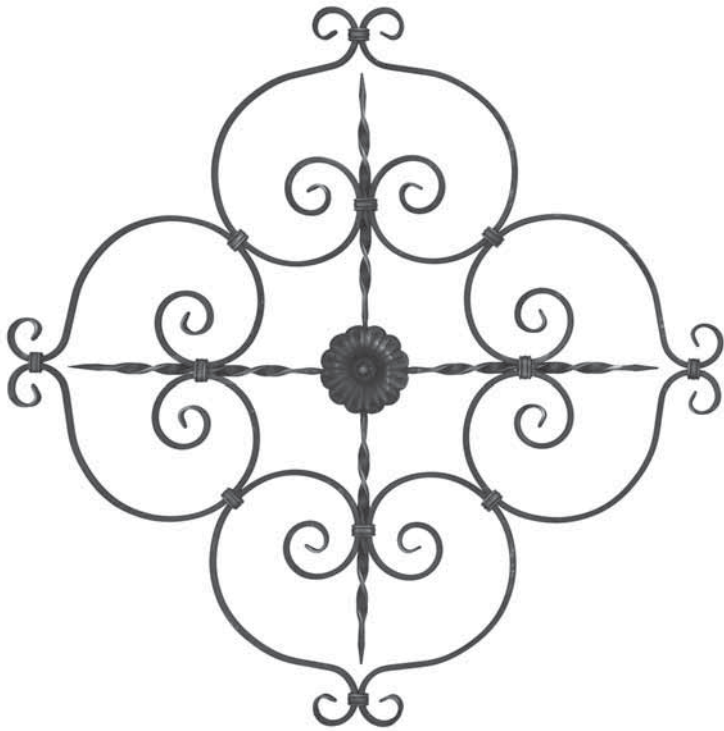

Liscio / Smooth
H.970 x L.970 mm
Art. 03.034.35 \neq 16 x 8

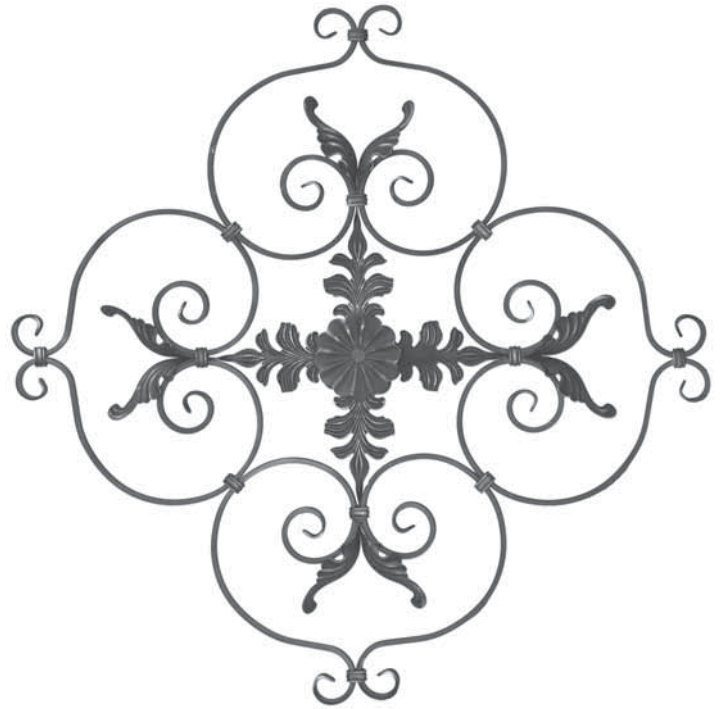

Liscio / Smooth
H.970 x L.970 mm
Art. 03.034.36 \neq 16 x 8



Liscio / Smooth
L.200 x H.200 mm
Art. 03.034.38 \neq 12 x 6

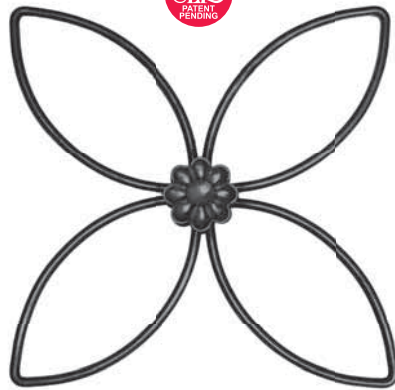

Liscio / Smooth
L.315 x H.315 mm
Art. 03.034.39 \varnothing 8



Martellato / Hammered
H.950 x L.430 mm
Art. 03.034.40 \square 12
Fiori su ambo i lati
Flowers on both sides

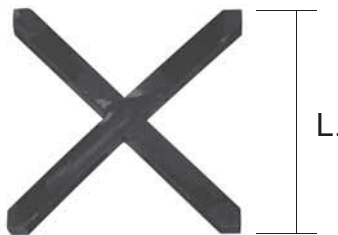

Liscio / Smooth
Art. 03.034.60 \square 12 L.100 x H.100 mm
Art. 03.034.61 \square 12 L.110 x H.110 mm
Art. 03.034.62 \square 12 L.125 x H.125 mm
Art. 03.034.63 \square 12 L.108 x H.108 mm

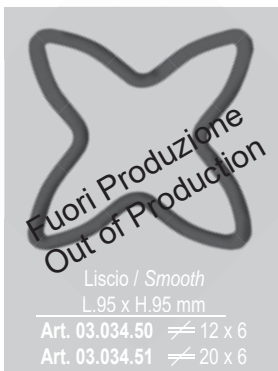

Liscio / Smooth
L.95 x H.95 mm
Art. 03.034.50 \neq 12 x 6
Art. 03.034.51 \neq 20 x 6



Modello Scala / *Scala Model*
H.155 X L.180 mm.
Art. 03.035 ≙ 10 X 5



Modello Scala / *Scala Model*
H.180 X L.130 mm.
Art. 03.035.01 ≙ 10 X 5



Modello Scala / *Scala Model*
H.155 X L.180 mm.
Art. 03.036 ≙ 10 X 5

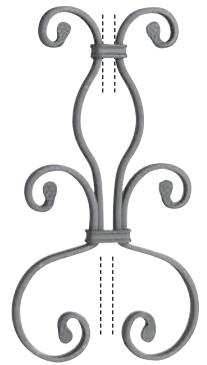

H.350 X L.190 mm.
Art. 03.036.01 ≙ 12 X 6



H.110 X L.125 mm.
Art. 03.036.02 ∅ 8



H.125 X L.115 mm.
Art. 03.037 ≙ 12 X 6
Art. 03.038 □ 8 X 8

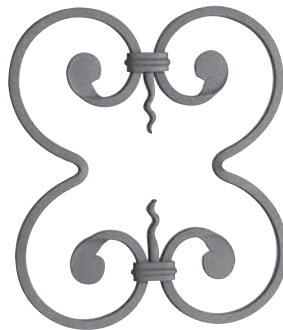

H.240 X L.210 mm.
Art. 03.038.01 □ 8 X 8



H.215 X L.155 mm.
Art. 03.039 ≙ 12 X 6

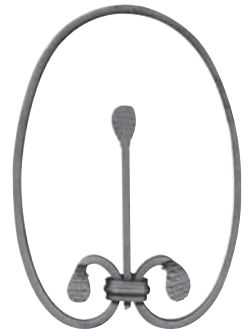

H.215 X L.155 mm.
Art. 03.040 ≙ 12 X 6



H.215 X L.165 mm.
Art. 03.041 ≙ 12 X 6



H.380 X L.185 mm.
Art. 03.042 ≙ 12 X 6

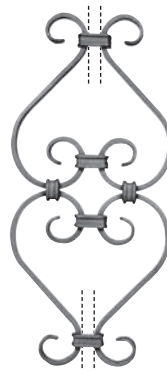

H.360 X L.165 mm.
Art. 03.043 ≙ 12 X 6

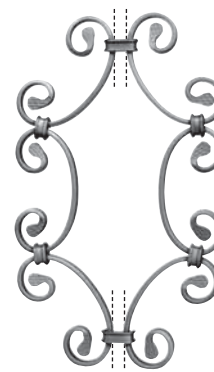

H.380 X L.230 mm.
Art. 03.044 ≙ 12 X 6

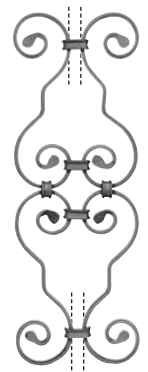

H.480 X L.170 mm.
Art. 03.045 ≙ 12 X 6



H.440 X L.225 mm.
Art. 03.046 ≙ 12 X 6



H.410 X L.200 mm.
Art. 03.047 ≙ 12 X 6



H.450 X L.205 mm.
Art. 03.048 ≙ 12 X 6



H.330 X L.180 mm.
Art. 03.049 ≙ 12 X 6

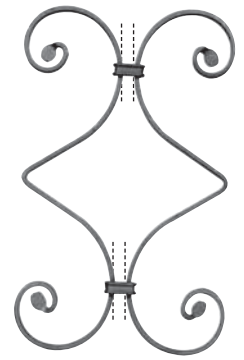

H.385 X L.230 mm.
Art. 03.050 ≙ 12 X 6

Tutte le parti di questo catalogo - foto comprese - sono di proprietà Euro-Fer. La riproduzione, anche parziale, è vietata in ogni forma e con ogni mezzo. / Every part of this catalogue - photos included - is Euro-Fer's property. All forms of copying are strictly prohibited.

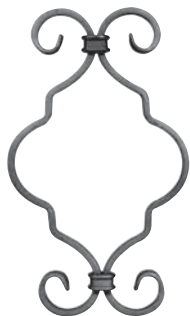

H.250 X L.160 mm.
Art. 03.051 ≙ 12 X 6



H.185 X L.200 mm.
Art. 03.051.01 ≙ 12 X 6
Art. 03.051.06 ≙ 14 X 6

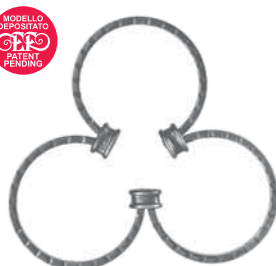

H.185 X L.200 mm.
Art. 03.051.02 ≙ 12 X 6
Art. 03.051.07 ≙ 14 X 6
Modello Scala / Scala Model



H.380 X L.135 mm.
Art. 03.051.03 ≙ 12 X 6



H.300 X L.115 mm.
Art. 03.051.04 ≙ 12 X 6
Art. 03.051.05 ≙ 14 X 6
Modello Scala / Scala Model



Liscio / Smooth
H.440 x L.160 mm
Art. 03.051.08 ≙ 14 x 6 mm
Art. 03.051.09 ≙ 16 x 6 mm



Liscio / Smooth
H.420 x L.180 mm
Art. 03.051.10 ≙ 12 x 6
Art. 03.051.11 ≙ 14 x 6

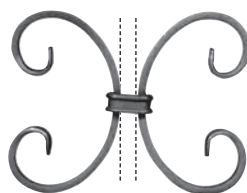

H.135 X L.165 mm.
Art. 03.052 ≙ 12 X 6

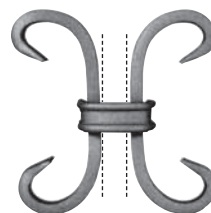

H.95 X L.95 mm.
Art. 03.053 ≙ 12 X 6

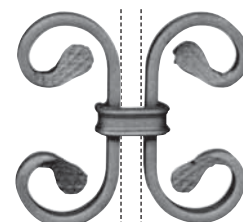

H.100 X L.110 mm.
Art. 03.054 ≙ 12 X 6



Liscio / Smooth
H.200 X L.190 mm.
Art. 03.055 ∅ 10



Liscio / Smooth
H.100 X L.210 mm.
Art. 03.056 ≙ 12 X 6



Liscio / Smooth
H.100 X L.265 mm.
Art. 03.057 ∅ 10



Liscio / Smooth
H.85 X L.230 mm.
Art. 03.058 ≙ 12 X 6



Liscio / Smooth
H.250 X L.170 mm.
Art. 03.059 □ 14 X 14



Liscio / Smooth
H.190 mm.
Art. 03.060 ≙ 12 X 6



Liscio / Smooth
H.290 X L.100 mm.
Art. 03.061 ≙ 12 X 6



Liscio / Smooth
H.125 mm.
Art. 03.062 □ 8 X 8



Liscio / Smooth
H.340 mm.
Art. 03.063 ∅ 12
Sinistro - Left



Liscio / Smooth
H.340 mm.
Art. 03.064 ∅ 12
Destro - Right



Liscio / Smooth
H.390 X L.200 mm.
Art. 03.065 Ø 8

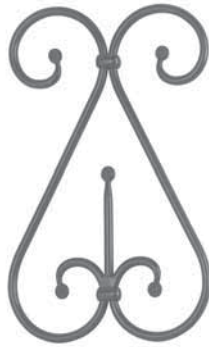

Liscio / Smooth
H.370 X L.240 mm.
Art. 03.066 Ø 10

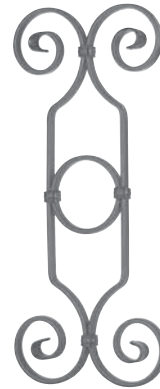

Liscio / Smooth
H.470 X L.210 mm.
Art. 03.067 ≙ 12 X 6
Art. 03.067.01 ≙ 14 X 6

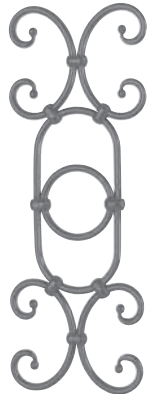

Liscio / Smooth
H.495 X L.180 mm.
Art. 03.068 Ø 10

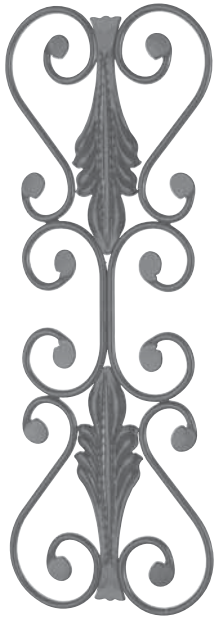

Liscio / Smooth
H.620 X L.235 mm.
Art. 03.069 Ø 8



Liscio / Smooth
H.460 X L.185 mm.
Art. 03.070 ≙ 12 X 6
Art. 03.070.01 ≙ 14 X 6

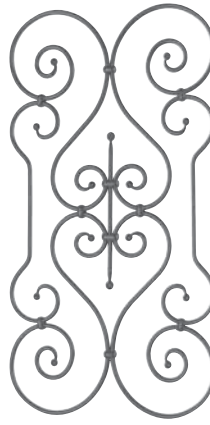

Liscio / Smooth
H.840 X L.440 mm.
Art. 03.071 Ø 10
Art. 03.071.01 Ø 12



Liscio / Smooth
H.400 X L.125 mm
Art. 03.080 □ 12 X 12

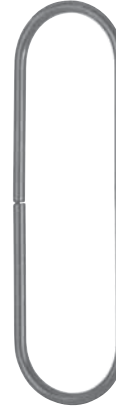

Liscio / Smooth
H.400 X L.125 mm.
Art. 03.081 Ø 12

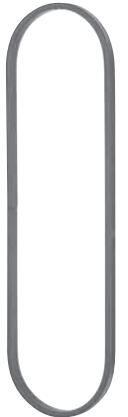

Liscio / Smooth
H.400 X L.115 mm.
Art. 03.082 ≙ 12 X 6

OVALI NON SALDATI / NOT WELDED OVALS

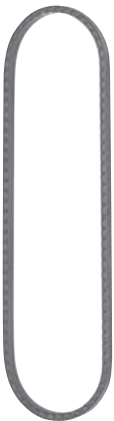

Mod. Scala / Scala Model
H.400 X L.115 mm.
Art. 03.083 ≙ 12 X 6



Liscio / Smooth
H.400 X L.125 mm
Art. 03.084 □ 12 X 12



Liscio / Smooth
H.400 X L.125 mm.
Art. 03.085 Ø 12



Liscio / Smooth
H.400 X L.115 mm.
Art. 03.086 ≙ 12 X 6



Mod. Scala / Scala Model
H.400 X L.115 mm.
Art. 03.087 ≙ 12 X 6



Liscio / Smooth
Art. 03.088 □ 14 H.710 x L.126 mm
Art. 03.088.01 □ 14 H.590 x L.126 mm
Art. 03.088.02 □ 14 H.540 x L.126 mm
Art. 03.088.03 □ 14 H.410 x L.126 mm

Tutte le parti di questo catalogo - foto comprese - sono di proprietà Euro-Fer. La riproduzione, anche parziale, è vietata in ogni forma e con ogni mezzo. / Every part of this catalogue - photos included - is Euro-Fer's property. All forms of copying are strictly prohibited.



Liscio / Smooth
H.175 X L.500 mm.
Art. 03.090 \neq 12 X 6



Liscio / Smooth
H.210 X L.530 mm.
Art. 03.091 \neq 12
Art. 03.091.01 \neq 14



Liscio / Smooth
H.260 X L.885 mm.
Art. 03.092 \neq 12



Liscio / Smooth
H.300 X L.835 mm.
Art. 03.093 \neq 20 X 5



Liscio / Smooth
H.235 X L.580 mm.
Art. 03.094 \neq 10



Liscio / Smooth
H.235 X L.860 mm.
Art. 03.095 \neq 10



Liscio / Smooth
 H.330 X L.1000 mm.
 Art. 03.096 □ 12
 Art. 03.096.01 □ 14
 Art. 03.096.02 □ 16



Liscio / Smooth
 L.1000 x H.110 mm
 Art. 03.096.50 Ø 10
 Con fiori su ambo i lati /
 Flowers on both sides



Liscio / Smooth
 L.1000 x H.110 mm
 Art. 03.096.51 □ 10
 Con fiori su ambo i lati /
 Flowers on both sides



Attorcigliato / Twisted
 L.1000 x H.110 mm
 Art. 03.096.52 □ 10
 Con fiori su ambo i lati /
 Flowers on both sides



Modello Scala / Scala Model
 L.1000 x H.110 mm
 Art. 03.096.53 ≇ 12 x 6
 Con fiori su ambo i lati /
 Flowers on both sides



Liscio / Smooth
 L.1230 x H.350 mm
 Art. 03.097 ≇ 30 x 10

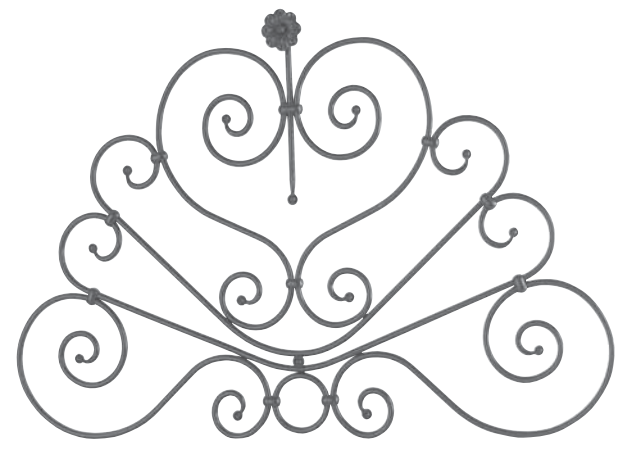

Liscio / Smooth
 H.630 X L.930 mm.
 Art. 03.100 Ø 10
 Art. 03.100.01 Ø 12



Liscio / Smooth
 H.900 X L.1300 mm.
 Art. 03.101 Ø 12

Tutte le parti di questo catalogo - foto comprese - sono di proprietà Euro-Fer. La riproduzione, anche parziale, è vietata in ogni forma e con ogni mezzo. / Every part of this catalogue - photos included - is Euro-Fer's property. All forms of copying are strictly prohibited.

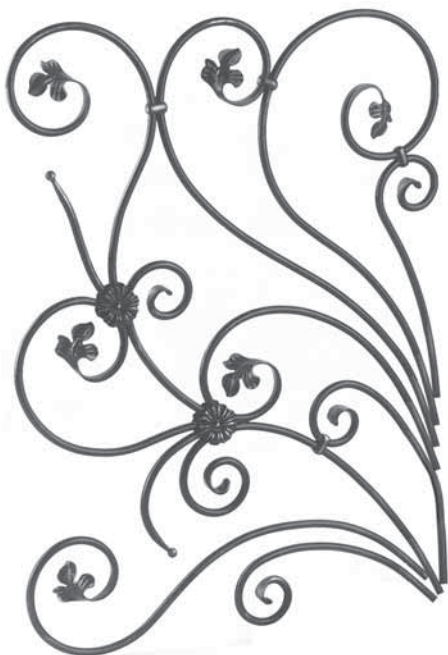

Liscio / Smooth
H.900 X L.650 mm.
Art. 03.102 \varnothing 12
Sinistro - Left

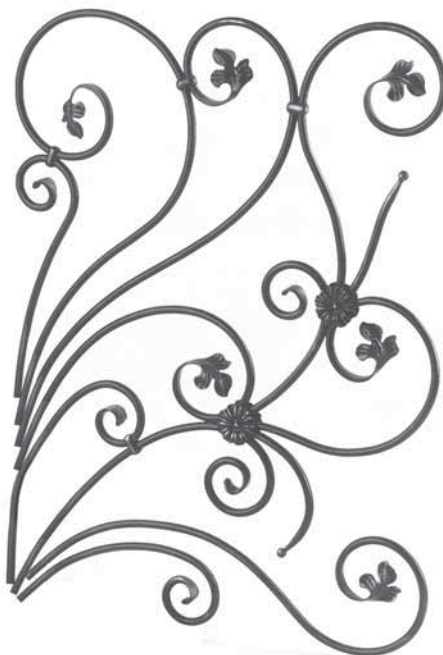

Liscio / Smooth
H.900 X L.650 mm.
Art. 03.103 \varnothing 12
Destro - Right

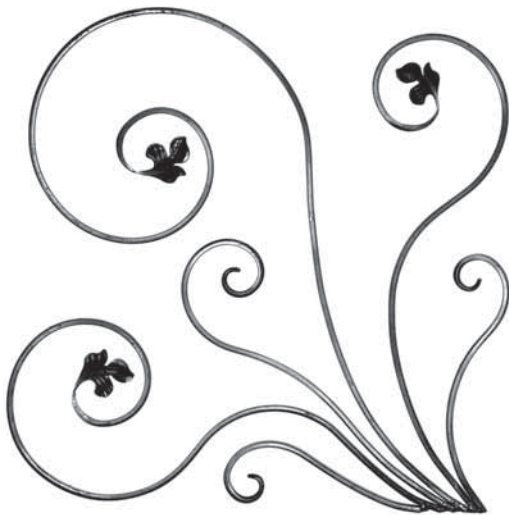

Liscio / Smooth
H.600 x L.600 mm
Art. 03.104 \varnothing 16 x 8
Sinistro / Left

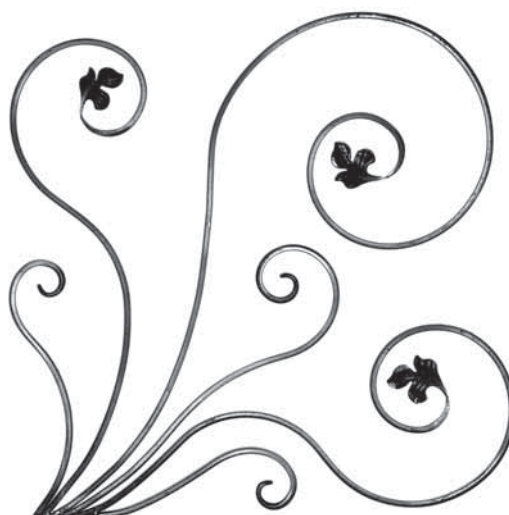

Liscio / Smooth
H.600 x L.600 mm
Art. 03.105 \varnothing 16 x 8
Destro / Right



Martellato / Hammered
H.600 x L.600 mm
Art. 03.106 \varnothing 16 x 8
Sinistro / Left

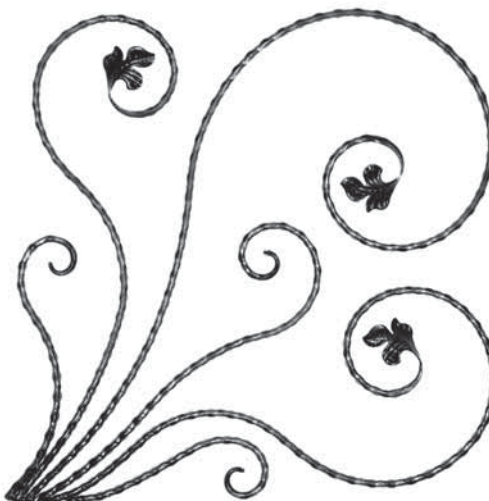

Martellato / Hammered
H.600 x L.600 mm
Art. 03.107 \varnothing 16 x 8
Destro / Right



03.400

Liscio / *Smooth*
H.296 x L.296 mm ca.
□ 12 mm

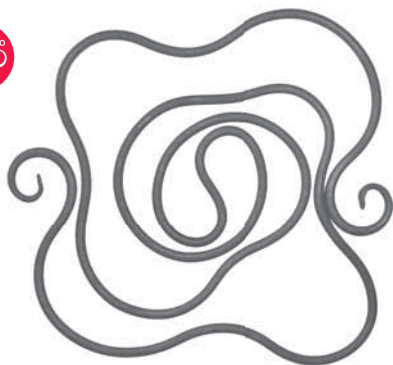

03.600

Martellato / *Hammered*
H.400 x L.400 mm ca.
Ø 12 mm

03.601

Modello Cortecchia / *Bark Model*
H.400 x L.400 mm ca.
Ø 12 mm

03.602

Liscio / *Smooth*
H.400 x L.400 mm ca.
Ø 10 mm

Art. 03.610

Liscio / *Smooth*
H. 400 x L.400 mm c.a.
□ 10 mm



Martellato / *Hammered*
H.85 x L.295 mm
Art. 03.645 ≙ 12 x 6



Martellato / *Hammered*
H.270 x L.245 mm
Art. 03.650 ≙ 12 x 6

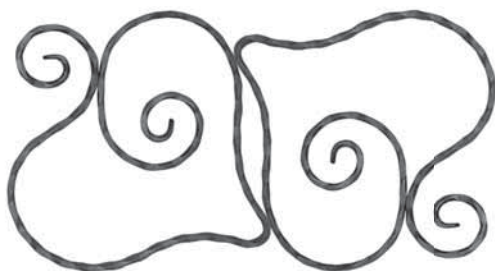

Martellato / *Hammered*
H.235 x L.390 mm
Art. 03.651. ≙ 12 x 6



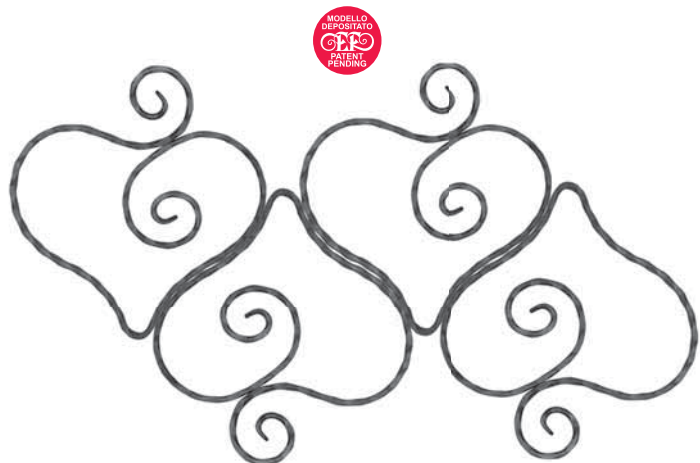

Martellato / *Hammered*
 H.410 x L.620 mm
 Art. 03.652. \neq 12 x 6

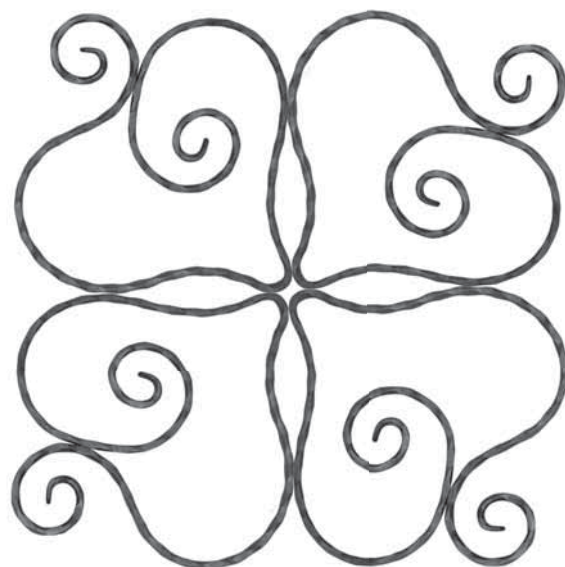

Martellato / *Hammered*
 H.430 x L.430 mm
 Art. 03.655. \neq 12 x 6



Martellato / *Hammered*
 H.510 x L.510 mm
 Art. 03.657 \neq 12 x 6

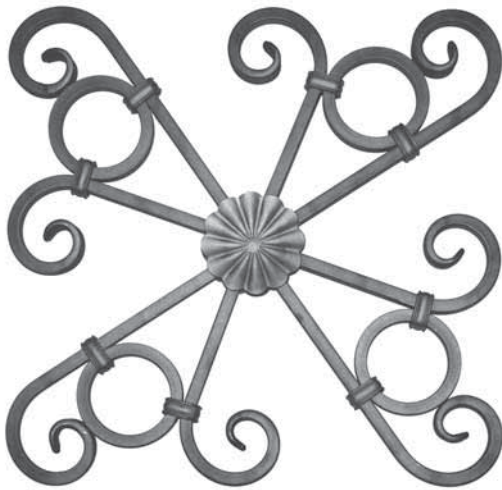

Liscio / Smooth
H.460 x L.460 mm
Art. 03.700 □ 12 mm



Liscio / Smooth
H.420 x L.420 mm
Art. 03.701 Ø 12 mm

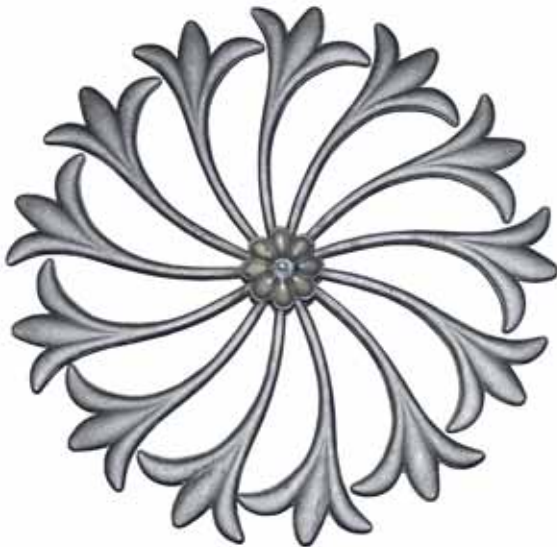

Liscio / Smooth
H.400 x L.400 mm
Art. 03.702
spessore / thickness 10 mm



Liscio / Smooth
H.460 x L.460 mm
Art. 03.703 Ø 12 mm

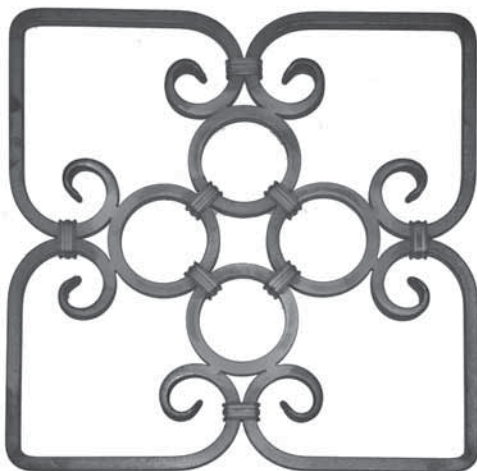

Liscio / Smooth
H.415 x L.415 mm
Art. 03.704 □ 12 mm

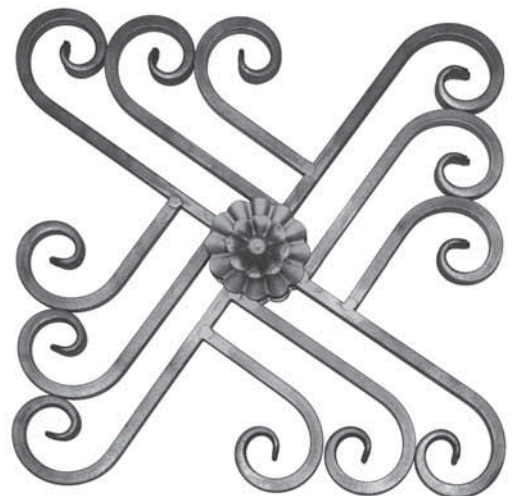

Liscio / Smooth
H.460 x L.460 mm
Art. 03.705 □ 12 mm



Tutte le parti di questo catalogo - foto comprese - sono di proprietà Euro-Fer. La riproduzione, anche parziale, è vietata in ogni forma e con ogni mezzo. / Every part of this catalogue - photos included - is Euro-Fer's property. All forms of copying are strictly prohibited.



Modello Mattone
Brick Model



H.950 X L.300 mm. \neq 40 X 4
Art. 04.001 Liscio / Smooth
Art. 04.002 Mattone / Brick



H.720 X L.250 mm. \neq 40 X 4
Art. 04.003 Liscio / Smooth
Art. 04.004 Mattone / Brick



H.720 X L.250 mm. \neq 40 X 4
Art. 04.005 Liscio / Smooth
Art. 04.006 Mattone / Brick



H.950 X L.220 mm. \neq 40 X 4
Art. 04.007 Liscio / Smooth
Art. 04.008 Mattone / Brick



H.950 X L.180 mm. \neq 40 X 4
Art. 04.009 Liscio / Smooth
Art. 04.010 Mattone / Brick



H.370 X L.125 mm. \neq 40 X 4
Art. 04.011 Liscio / Smooth
Art. 04.012 Mattone / Brick



Liscio / Smooth
H.440 X L.75 mm.
Art. 04.012.01 \neq 40 X 4

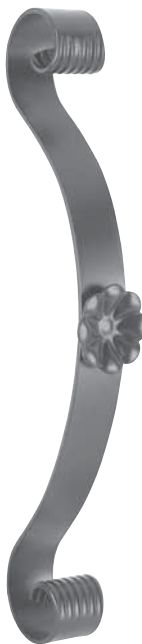

Liscio / Smooth
H.440 X L.75 mm.
Art. 04.012.02 \neq 40 X 4



Mattone / Brick
H.440 X L.75 mm.
Art. 04.012.03 \neq 40 X 4



Mattone / Brick
H.440 X L.75 mm.
Art. 04.012.04 \neq 40 X 4



H.800 X L.135 mm. Liscio / Smooth

Art. 04.013 ≙ 20 X 4
 Art. 04.014 ≙ 25 X 4
 Art. 04.015 ≙ 30 X 4
 Art. 04.016 ≙ 40 X 4



H.800 X L.135 mm. Mattone / Brick

Art. 04.017 ≙ 20 X 4
 Art. 04.018 ≙ 25 X 4
 Art. 04.019 ≙ 30 X 4
 Art. 04.020 ≙ 40 X 4



H.900 X L.240 mm. ≙ 40 X 6

Art. 04.021 Liscio / Smooth



Liscio / Smooth

H.950 X L.240 mm.

Art. 04.021.01 ≙ 40 X 4



Liscio / Smooth

H.950 X L.240 mm.

Art. 04.021.02 ≙ 40 X 4



Liscio / Smooth

H.950 X L.240 mm.

Art. 04.021.03 ≙ 40 X 4



Mattone / Brick

H.950 X L.240 mm.

Art. 04.021.04 ≙ 40 X 4



Mattone / Brick

H.950 X L.240 mm.

Art. 04.021.05 ≙ 40 X 4

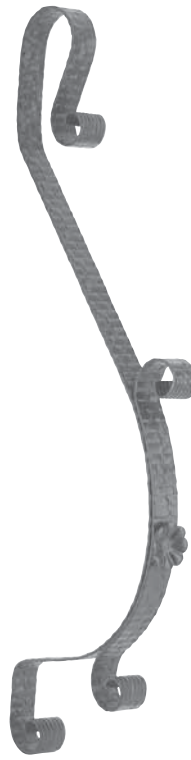

Mattone / Brick

H.950 X L.240 mm.

Art. 04.021.06 ≙ 40 X 4



H.950 x L.190 mm

Martellato / Hammered

Art. 04.021.10 ≙ 30 x 8 mm

Liscio / Smooth

Art. 04.021.11 ≙ 30 x 8 mm



H.750 X L.110 mm.
Art. 04.022 ≡ 20 X 4
Art. 04.023 ≡ 20 X 5

H.900 X L.180 mm.
Art. 04.024 ≡ 16 X 4
Art. 04.025 ≡ 20 X 6
Art. 04.026 □ 8 X 8

H.850 X L.170 mm.
Art. 04.027 ≡ 25 X 5

H.780 X L.250 mm.
Art. 04.028 ≡ 30 X 4
Art. 04.029 ≡ 25 X 5

Liscio / Smooth
H.730 x L.250 mm
Art. 04.029.01 ≡ 30 x 10

H.720 X L.130 mm.
Art. 04.030 ≡ 16 X 4
Art. 04.031 ≡ 10 X 5
Art. 04.032 ≡ 20 X 6
Art. 04.033 □ 8 X 8

H.720 X L.75 mm.
Art. 04.034 ≡ 16 X 4
Art. 04.035 ≡ 10 X 5
Art. 04.036 ≡ 20 X 6
Art. 04.037 □ 8 X 8

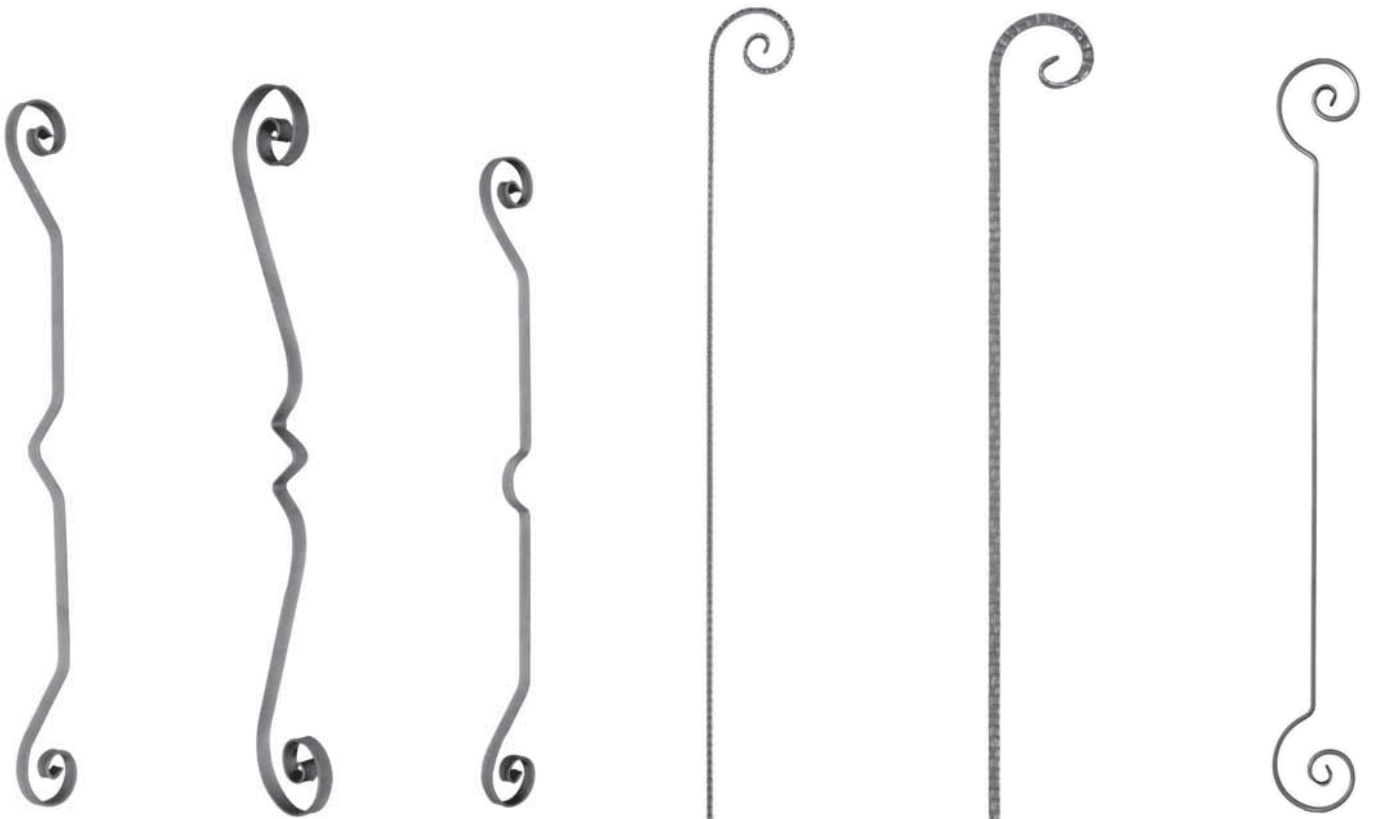

H.720 X L.75 mm.
Art. 04.038 ≡ 16 X 4
Art. 04.039 ≡ 10 X 5
Art. 04.040 ≡ 20 X 6
Art. 04.041 □ 8 X 8

H.800 X L.115 mm.
Art. 04.042 ≡ 16 X 4
Art. 04.043 ≡ 20 X 4
Art. 04.044 ≡ 25 X 4

H.720 X L.75 mm.
Art. 04.045 ≡ 16 X 4
Art. 04.046 ≡ 10 X 5
Art. 04.047 ≡ 20 X 6

Modello Scala / Scala Model
L.100 mm. ≡ 20 X 6
Art. 04.048.01 H.1000 mm.
Art. 04.048.02 H.1500 mm.

Modello Mattone / Brick Model
H. 1000 X L.110 mm.
Art. 04.048.03 □ 12 X 12

H.950 X L.100 mm.
Art. 04.048.04 ≡ 12 X 6
Art. 04.048.05 ≡ 14 X 6

Tutte le parti di questo catalogo - foto comprese - sono di proprietà Euro-Fer. La riproduzione, anche parziale, è vietata in ogni forma e con ogni mezzo. / Every part of this catalogue - photos included - is Euro-Fer's property. All forms of copying are strictly prohibited.



H.950 X L.100 mm.
Art. 04.048.06 □ 12 X 12
Art. 04.048.07 □ 14 X 14

H.950 X L.125 mm.
Art. 04.048.08 ≡ 12 X 6
Art. 04.048.09 ≡ 14 X 6

L.170 mm. □ 10 X 10
Art. 04.049 H. 720 mm.
Art. 04.050 H. 820 mm.
Art. 04.051 H. 900 mm.
Art. 04.052 H.1000 mm.

L.115 mm. □ 12 X 12
Art. 04.056.01 H. 650 mm.
Art. 04.056.02 H. 720 mm.
Art. 04.056.03 H.1200 mm.

Martellato / Hammered
 L.90 mm. □ 12 X 12
Art. 04.056.07 H. 650 mm.
Art. 04.056.08 H. 720 mm.
Art. 04.056.09 H.1200 mm.

H.520 X L.200 mm.
Art. 04.056.13 □ 12 X 12
Art. 04.056.17 □ 14 X 14
Art. 04.056.18 □ 16 X 16

L.170 mm. □ 12 X 12
Art. 04.053 H. 720 mm.
Art. 04.054 H. 820 mm.
Art. 04.055 H. 900 mm.
Art. 04.056 H.1000 mm.

L.115 mm. □ 14 X 14
Art. 04.056.04 H. 650 mm.
Art. 04.056.05 H. 720 mm.
Art. 04.056.06 H.1200 mm.

L.90 mm. □ 14 X 14
Art. 04.056.10 H. 650 mm.
Art. 04.056.11 H. 720 mm.
Art. 04.056.12 H.1200 mm.



H.690 X L.260 mm.
Art. 04.056.14 □ 20 X 20

L.235 mm. ≡ 20 X 6
Art. 04.056.15 H.660 mm.
Art. 04.056.16 H.760 mm.

Liscio / Smooth
 H.600 x L.290 mm
Art. 04.056.20 □ 12

L.250 mm. □ 12 X 12
Art. 04.057 H. 720 mm.
Art. 04.058 H. 820 mm.
Art. 04.059 H. 900 mm.
Art. 04.060 H.1200 mm.
Art. 04.061 H. 1500 mm.
Art. 04.062 H. 1800 mm.

L.250 mm. □ 14 X 14
Art. 04.057.01 H. 720 mm.
Art. 04.058.01 H. 820 mm.
Art. 04.059.01 H. 900 mm.
Art. 04.060.01 H.1200 mm.
Art. 04.061.01 H.1500 mm.
Art. 04.062.01 H.1800 mm.

L.250 mm. □ 16 X 16
Art. 04.057.02 H. 720 mm.
Art. 04.058.02 H. 820 mm.
Art. 04.059.02 H. 900 mm.
Art. 04.060.02 H.1200 mm.
Art. 04.061.02 H 1500 mm.
Art. 04.062.02 H 1800 mm.



Rigato / Fluted

L.210 mm. □ 12 X 12
Art. 04.063 H.1000 mm.
Art. 04.064 H.1200 mm.



Rigato / Fluted

L.210 mm. □ 12 X 12
Art. 04.065 H.1000 mm.
Art. 04.066 H.1200 mm.



L.200 mm. □ 12 X 12
Art. 04.067 H. 950 mm.
Art. 04.068 H.1200 mm.
Art. 04.069 H.1500 mm.
Art. 04.070 H.1800 mm.

L.200 mm. □ 14 X 14
Art. 04.071 H. 950 mm.
Art. 04.072 H.1200 mm.
Art. 04.073 H.1500 mm.
Art. 04.074 H.1800 mm.



L.125 mm. □ 12 X 12
Art. 04.075 H. 950 mm.
Art. 04.076 H.1200 mm.
Art. 04.077 H.1500 mm.
Art. 04.078 H.1800 mm.

L.125 mm. □ 14 X 14
Art. 04.079 H. 950 mm.
Art. 04.080 H.1200 mm.
Art. 04.081 H.1500 mm.
Art. 04.082 H.1800 mm.



L.125 mm. □ 12 X 12
Art. 04.083 H. 950 mm.
Art. 04.084 H.1200 mm.
Art. 04.085 H.1500 mm.
Art. 04.086 H.1800 mm.

L.125 mm. □ 14 X 14
Art. 04.087 H. 950 mm.
Art. 04.088 H.1200 mm.
Art. 04.089 H.1500 mm.
Art. 04.090 H.1800 mm.



Liscio / Smooth

H.950 X L.205 mm.
Art. 04.090.01 □ 14 X 14



Martellato / Hammered

H.950 x L.125 mm
Art. 04.090.09 □ 12 X 12 mm



Liscio / Smooth

H.950 mm
Art. 04.090.10 □ 12
Art. 04.090.11 □ 14
Art. 04.090.12 □ 16



L.200 mm. □ 12 X 12
Art. 04.091 H. 950 mm.
Art. 04.092 H.1200 mm.
Art. 04.093 H.1500 mm.
Art. 04.094 H.1800 mm.



H.950 X L.170 mm.
Art. 04.095 □ 12 X 12



H.540 X L.115 mm.
Art. 04.096 □ 10 X 10
Art. 04.097 □ 12 X 12



Martellato / Hammered
H.540 X L.115 mm.
Art. 04.098 □ 12 X 12



Martellato / Hammered

L.200 mm. □ 12 X 12
 Art. 04.098.01 H. 950 mm.
 Art. 04.098.02 H.1200 mm.
 Art. 04.098.03 H.1500 mm.
 Art. 04.098.04 H.1800 mm.

L.200 mm. □ 14 X 14
 Art. 04.098.05 H. 950 mm.
 Art. 04.098.06 H.1200 mm.
 Art. 04.098.07 H.1500 mm.
 Art. 04.098.08 H.1800 mm.



L.200 mm. □ 12 X 12
 Art. 04.098.09 H. 950 mm.
 Art. 04.098.10 H.1200 mm.
 Art. 04.098.11 H.1500 mm.
 Art. 04.098.12 H.1800 mm.

L.200 mm. □ 14 X 14
 Art. 04.098.13 H. 950 mm.
 Art. 04.098.14 H.1200 mm.
 Art. 04.098.15 H.1500 mm.
 Art. 04.098.16 H.1800 mm.



Tondo / Round

L.200 mm. Ø 14
 Art. 04.098.17 H. 950 mm.
 Art. 04.098.18 H.1200 mm.
 Art. 04.098.19 H.1500 mm.
 Art. 04.098.20 H.1800 mm.

L.200 mm. Ø 16
 Art. 04.098.21 H. 950 mm.
 Art. 04.098.22 H.1200 mm.
 Art. 04.098.23 H.1500 mm.
 Art. 04.098.24 H.1800 mm.

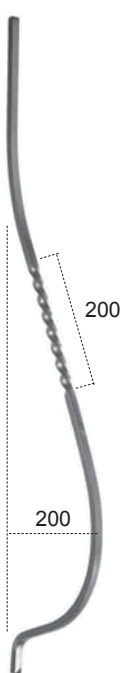

L.200 mm. □ 12 X 12
 Art. 04.098.25 H. 950 mm.
 Art. 04.098.26 H.1200 mm.
 Art. 04.098.27 H.1500 mm.
 Art. 04.098.28 H.1800 mm.

L.200 mm. □ 14 X 14
 Art. 04.098.29 H. 950 mm.
 Art. 04.098.30 H.1200 mm.
 Art. 04.098.31 H.1500 mm.
 Art. 04.098.32 H.1800 mm.

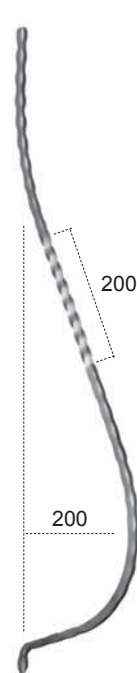

Martellato / Hammered

L.200 mm. □ 12 X 12
 Art. 04.099 H. 950 mm.
 Art. 04.100 H.1200 mm.
 Art. 04.101 H.1500 mm.
 Art. 04.102 H.1800 mm.



Martellato / Hammered

L.200 mm. □ 12 X 12
 Art. 04.103 H. 950 mm.
 Art. 04.104 H.1200 mm.
 Art. 04.105 H.1500 mm.
 Art. 04.106 H.1800 mm.

L.200 mm. □ 14 X 14
 Art. 04.106.01 H. 950 mm.
 Art. 04.106.02 H.1200 mm.
 Art. 04.106.03 H.1500 mm.
 Art. 04.106.04 H.1800 mm.

Attorcigliato, Martellato e Rigato
Fluted, Hammered and Twisted

L.200 mm. □ 14 X 14
 Art. 04.106.21 H.950 mm.



Martellato / Hammered

L.200 mm. □ 12 X 12
 Art. 04.106.30 H.950 mm.



Martellato / Hammered

L.200 mm. □ 12 X 12
 Art. 04.106.31 H.950 mm.



Martellato / Hammered

L.200 mm. □ 12 X 12
 Art. 04.107 H. 950 mm.
 Art. 04.108 H.1200 mm.
 Art. 04.109 H.1500 mm.
 Art. 04.110 H.1800 mm.

L.200 mm. □ 14 X 14
 Art. 04.110.01 H. 950 mm.
 Art. 04.110.02 H.1200 mm.
 Art. 04.110.03 H.1500 mm.
 Art. 04.110.04 H.1800 mm.

L.200 mm. □ 12 X 12
 Art. 04.106.05 H. 950 mm.
 Art. 04.106.06 H.1200 mm.
 Art. 04.106.07 H.1500 mm.
 Art. 04.106.08 H.1800 mm.

L.200 mm. □ 14 X 14
 Art. 04.106.09 H. 950 mm.
 Art. 04.106.10 H.1200 mm.
 Art. 04.106.11 H.1500 mm.
 Art. 04.106.12 H.1800 mm.

Tondo / Round

L.200 mm. Ø 14
 Art. 04.106.13 H. 950 mm.
 Art. 04.106.14 H.1200 mm.
 Art. 04.106.15 H.1500 mm.
 Art. 04.106.16 H.1800 mm.

L.200 mm. Ø 16
 Art. 04.106.17 H. 950 mm.
 Art. 04.106.18 H.1200 mm.
 Art. 04.106.19 H.1500 mm.
 Art. 04.106.20 H.1800 mm.



L.200 mm. □ 12 X 12
Art. 04.110.05 H. 950 mm.
Art. 04.110.06 H.1200 mm.
Art. 04.110.07 H.1500 mm.
Art. 04.110.08 H.1800 mm.

Martellato / Hammered
 L.200 mm. □ 12 X 12
Art. 04.111 H. 950 mm.
Art. 04.112 H.1200 mm.
Art. 04.113 H.1500 mm.
Art. 04.114 H.1800 mm.

L.200 mm. □ 12 X 12
Art. 04.114.05 H. 950 mm.
Art. 04.114.06 H.1200 mm.
Art. 04.114.07 H.1500 mm.
Art. 04.114.08 H.1800 mm.

Martellato / Hammered
 L.200 mm. □ 12 X 12
Art. 04.115 H. 950 mm.
Art. 04.116 H.1200 mm.
Art. 04.117 H.1500 mm.
Art. 04.118 H.1800 mm.

L.200 mm. □ 12 X 12
Art. 04.118.05 H. 950 mm.
Art. 04.118.06 H.1200 mm.
Art. 04.118.07 H.1500 mm.
Art. 04.118.08 H.1800 mm.

Forgiato / Forged
 H.950 x L.150 mm
Art. 04.118.40 ≙ 13 x 10 mm

L.200 mm. □ 14 X 14
Art. 04.110.09 H. 950 mm.
Art. 04.110.10 H.1200 mm.
Art. 04.110.11 H.1500 mm.
Art. 04.110.12 H.1800 mm.

L.200 mm. □ 14 X 14
Art. 04.114.01 H. 950 mm.
Art. 04.114.02 H.1200 mm.
Art. 04.114.03 H.1500 mm.
Art. 04.114.04 H.1800 mm.

L.200 mm. □ 14 X 14
Art. 04.114.09 H. 950 mm.
Art. 04.114.10 H.1200 mm.
Art. 04.114.11 H.1500 mm.
Art. 04.114.12 H.1800 mm.

L.200 mm. □ 14 X 14
Art. 04.118.01 H. 950 mm.
Art. 04.118.02 H.1200 mm.
Art. 04.118.03 H.1500 mm.
Art. 04.118.04 H.1800 mm.

L.200 mm. □ 14 X 14
Art. 04.118.09 H. 950 mm.
Art. 04.118.10 H.1200 mm.
Art. 04.118.11 H.1500 mm.
Art. 04.118.12 H.1800 mm.



Forgiato / Forged
 H.950 x L.150 mm
Art. 04.118.45 ≙ 13 x 10 mm

Liscio / Smooth
 H.720 x L.260mm
Art. 04.118.99 Ø 12

H.730 X L.250 mm.
Art. 04.119 ≙ 20 X 6

Modello Scala / Scala Model
 H.730 X L.250 mm.
Art. 04.119.01 ≙ 20 X 6

Tondo / Round
 H.750 X L.250 mm.
Art. 04.119.02 Ø 14

H.470 X L.180 mm.
Art. 04.119.03 ≙ 20 X 6



H.850 X L.235 mm. Sinistro/Left
Art. 04.119.04 ≙ 20 X 6
 H.950 X L.235 mm. Sinistro/Left
Art. 04.119.06 ≙ 20 X 6



H.850 X L.235 mm. Destro/Right
Art. 04.119.05 ≙ 20 X 6
 H.950 X L.235 mm. Destro/Right
Art. 04.119.07 ≙ 20 X 6



Martellato / Hammered
 H.900 X L.380 mm.
Art. 04.119.08 □ 25 X 25



Martellato / Hammered
 H.750 X L.350 mm.
Art. 04.119.09 □ 12 mm ≙ 12 X 6
Art. 04.119.10 □ 14 mm ≙ 12 X 6
Art. 04.120 □ 16 mm ≙ 16 X 8



Martellato / Hammered
 H.480 X L.220 mm.
Art. 04.120.01 □ 12 mm ≙ 12 X 6
Art. 04.120.02 □ 14 mm ≙ 12 X 6
Art. 04.120.03 □ 16 mm ≙ 16 X 8



Battuto / Wrought
 H.800 X L.305 mm.
Art. 04.120.04 ≙ 25 X 10



H.700 X L.250 mm.
Art. 04.120.05 ≙ 20 X 8



H.730 X L.240 mm.
Art. 04.121 ≙ 20 X 6



Modello Scala / Scala Model
 H.730 X L.240 mm.
Art. 04.121.01 ≙ 20 X 6



Liscio / Smooth
 H.740 X L.250 mm.
Art. 04.140 □ 10 mm



Liscio / Smooth
 H.770 X L.280 mm.
Art. 04.141 Ø 25 mm



Rigato / Fluted
 H.550 X L.250 mm.
Art. 04.142 ≙ 16 X 8



Liscio / Smooth
 H.570 X L.160 mm.
Art. 04.143 ≙ 14 X 6
Art. 04.143.01 ≙ 16 X 6

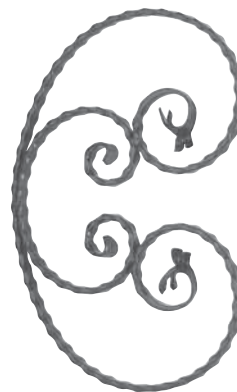

Martellato / Hammered
 H.480 X L.330 mm.
Art. 04.145 ≙ 18 X 10



Liscio / Smooth
 H.885 X L.265 mm.
Art. 04.146 Ø 12 mm
Art. 04.146.01 Ø 14 mm
Art. 04.146.02 Ø 16 mm



Gli articoli della Linea Liberty possono includere particolari in ghisa o ferro fuso.
 The items of the Liberty Line could contain casting parts.



H.280 x L.210 mm
 Art. 04.400 Ø 10 mm
 Sinistro / Left

H.280 x L.210 mm
 Art. 04.401 Ø 10 mm
 Destro / Right



Martellato / Hammered
 H.400 x L.200 mm
 Art. 04.402 ≠ 16 X 8 mm
 Sinistro / Left

Martellato / Hammered
 H.400 x L.200 mm
 Art. 04.403 ≠ 16 X 8 mm
 Destro / Right



Martellato / Hammered
 H.400 x L.250 mm
 Art. 04.404 ≠ 16 X 8 mm
 Sinistro / Left

Martellato / Hammered
 H.400 x L.250 mm
 Art. 04.405 ≠ 16 x 8 mm
 Destro / Right



Martellato / Hammered
 H.450 x L.300 mm
 Art. 04.406 ≠ 16 x 8 mm
 Sinistro / Left

Martellato / Hammered
 H.450 x L.300 mm
 Art. 04.407 ≠ 16 x 8 mm
 Destro / Right

Tutte le parti di questo catalogo - foto comprese - sono di proprietà Euro-Fer. La riproduzione, anche parziale, è vietata in ogni forma e con ogni mezzo. / Every part of this catalogue - photos included - is Euro-Fer's property. All forms of copying are strictly prohibited.



Martellato / Hammered
H.500 x L.260 mm
Art. 04.408 \neq 16 x 8 mm
Sinistro / Left

Martellato / Hammered
H.500 x L.260 mm
Art. 04.409 \neq 16 X 8 mm
Destro / Right



H.370 X L.330 mm.
Art. 04.500 \varnothing 12 mm

H.370 X L.330 mm.
Art. 04.501 \varnothing 12 mm



H.460 X L.440 mm.
Art. 04.502 \varnothing 12 mm

H.460 X L.440 mm.
Art. 04.503 \varnothing 12 mm



H.620 X L.410 mm.
Art. 04.505 \varnothing 12 mm

H.620 X L.410 mm.
Art. 04.506 \varnothing 12 mm



H.970 X L.780 mm.
Art. 04.507 \varnothing 12 mm



H.970 X L.780 mm.
Art. 04.508 \varnothing 12 mm



H.970 X L.780 mm.
Art. 04.509 Ø 12 mm



H.970 X L.780 mm.
Art. 04.510 Ø 12 mm



H.550 x L.750 mm
Art. 04.516 Ø 12 mm



H.550 X L.750 mm.
Art. 04.517 Ø 12 mm



H.970 X L.420 mm.
Art. 04.520 Ø 12 mm



H.970 X L.420 mm.
Art. 04.521 Ø 12 mm



Rigato / Fluted
H.870 x L.380 mm
Art. 04.522 ≠ 16 X 8 mm



Rigato / Fluted
H.870 x L.380 mm
Art. 04.523 ≠ 16 X 8 mm



Rigato / Fluted
H.715 x L.190 mm
Art. 04.528 \neq 16 x 8 mm
Sinistro / Left



Rigato / Fluted
H.715 x L.190 mm
Art. 04.529 \neq 16 x 8 mm
Destro / Right

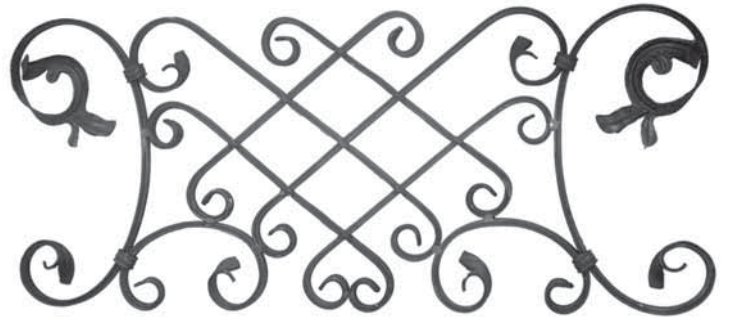

Rigato / Fluted
H.370 X L.880 mm.
Art. 04.530 \neq 16 X 8



Rigato / Fluted
H.710 X L.640 mm.
Art. 04.531 \neq 16 X 8

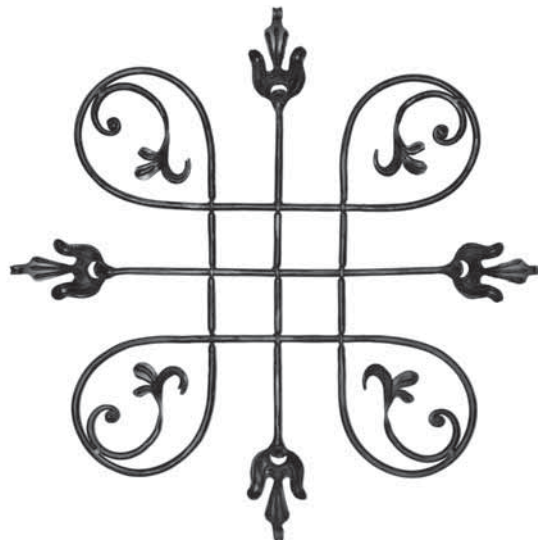

Rigato / Fluted
H.720 x L.720 mm
Art. 04.533 \neq 16 x 8 mm

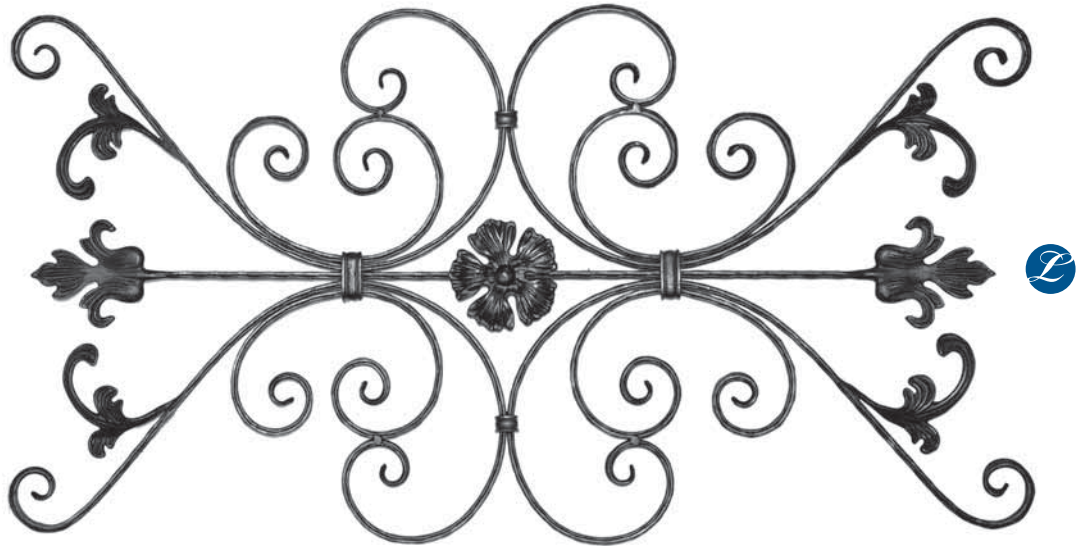

Rigato / Fluted
H.1010 x L.540 mm
Art. 04.536 \neq 20 x 8 mm



Martellato / Hammered
H.900 x L.350 mm
Art. 04.538 \square 12 mm



Martellato / Hammered
H.440 x L.330 mm
Art. 04.580



Martellato / Hammered
H.410 x L.370 mm
Art. 04.581

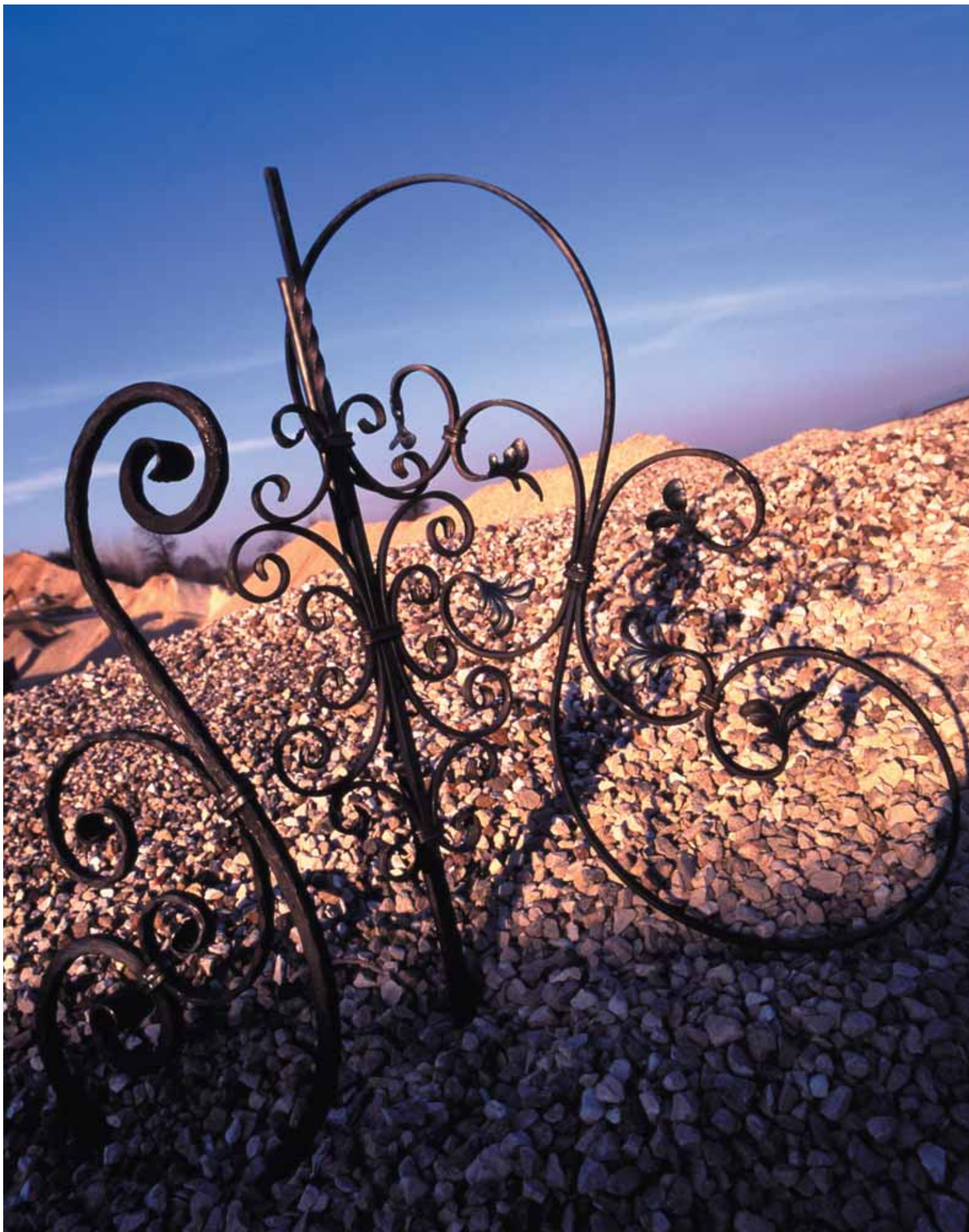



H.800 X L.65
Art. 05.001
 ≧ 20 X 4



H.750 X L.110
Art. 05.002
 ≧ 20 X 4



H.750 X L.110
Art. 05.003
 ≧ 20 X 4



H.750 X L.130
Art. 05.004
 ≧ 20 X 4



H.750 X L.110
Art. 05.005
 ≧ 20 X 4



H.800 X L.110
Art. 05.006
 ≧ 20 X 4



H.750 X L.150
Art. 05.007
 ≧ 20 X 4

Gli elementi indicati qui sopra sono venduti singolarmente: sono accoppiati a titolo dimostrativo / The elements in the line above are sold separately: they are only in pairs for demonstration purposes



H.750 X L.115
Art. 05.008
 ≧ 20 X 4



H.750 X L.125
Art. 05.009
 ≧ 20 X 4



H.750 X L.90
Art. 05.010
 ≧ 20 X 4



H.750 X L.110
Art. 05.011
 ≧ 20 X 4



H.750 X L.110
Art. 05.012
 ≧ 20 X 4



H.750 X L.110
Art. 05.013
 ≧ 20 X 4



H.860 X L.140 mm.
Art. 05.014
 ≧ 20 X 4

Gli elementi indicati qui sopra sono venduti singolarmente: sono accoppiati a titolo dimostrativo / The elements in the line above are sold separately: they are only in pairs for demonstration purposes



H.860 X L.140 mm.
Art. 05.015
 ≧ 20 X 4



H.900 X L.165 mm.
Art. 05.016
 ≧ 20 X 6



L.160 mm. ≧ 20 X 4
Art. 05.017 H. 720
Art. 05.018 H. 820



H.860 X L.110 mm.
Art. 05.019
 ≧ 16 X 5



Modello Scala / *Scala Model*
 H.860 X L.145 mm.
Art. 05.020
 □ 8 X 8



Modello Scala / *Scala Model*
 H.720 X L.250 mm.
Art. 05.021
 □ 8 X 8

Tutte le parti di questo catalogo - foto comprese - sono di proprietà Euro-Fer. La riproduzione, anche parziale, è vietata in ogni forma e con ogni mezzo. / Every part of this catalogue - photos included - is Euro-Fer's property. All forms of copying are strictly prohibited.



Modello Scala / Scala Model

H.700 X L.250 mm.
Art. 05.022
□ 8 X 8



H.720 X L.250 mm.
Art. 05.023
≠ 16 X 4



Tondo / Round
H.870 X L.260 mm.
Art. 05.023.01
∅ 12



H.720 X L.250 mm.
Art. 05.024
≠ 16 X 4



H.720 X L.250 mm.
Art. 05.025
≠ 16 X 4

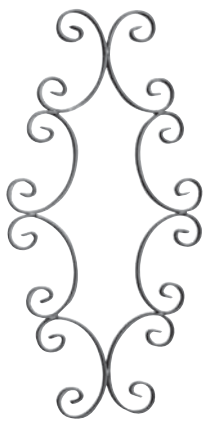

H.540 X L.250 mm.
Art. 05.026
≠ 16 X 4

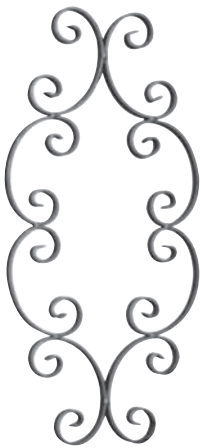

H.540 X L.250 mm.
Art. 05.027
≠ 16 X 4



H.720 X L.330 mm.
Art. 05.028
≠ 16 X 4



Ferro Spigolato
Edged Bar
H.950 X L.125 mm.
Art. 05.029
□ 14 X 14

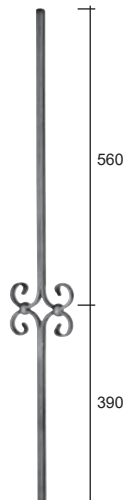

Ferro Spigolato
Edged Bar
H.950 X L.125 mm.
Art. 05.030
□ 14 X 14



Ferro Spigolato
Edged Bar
H.950 X L.125 mm.
Art. 05.031
□ 14 X 14



H.750 X L.200 mm.
Art. 05.032
3 ≠ 16 X 4



H.750 X L.200 mm.
Art. 05.033
3 ≠ 16 X 4



H.750 X L.200 mm.
Art. 05.034
4 ≠ 16 X 4



H.750 X L.200 mm.
Art. 05.035
4 ≠ 16 X 4



H.750 X L.200 mm.
Art. 05.036
3 ≠ 16 X 4



H.750 X L.200 mm.
Art. 05.037
3 ≠ 16 X 4



H.750 mm.
Art. 05.038 ≠ 16 X 4
Art. 05.039 ≠ 20 X 4
H.850 mm.
Art. 05.040 ≠ 16 X 4
Art. 05.041 ≠ 20 X 4



H.950 mm.
Art. 05.043.01
≠ 20 X 6



H.950 mm.
Art. 05.043.02
≠ 20 X 6

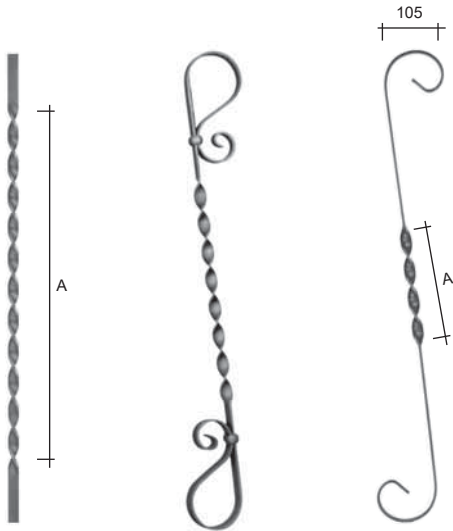

H.720 mm.
Art. 05.043.03
 ≡ 20 X 6
 A = 550 mm.

H.730 X L.90 mm.
Art. 05.044
 ≡ 20 X 4

H.350 mm. - A = 100 mm.
Art. 05.044.01 ≡ 20 X 5
 H.650 mm. - A = 220 mm.
Art. 05.044.02 ≡ 20 X 5
 H.850 mm. - A = 220 mm.
Art. 05.044.03 ≡ 20 X 5
 H.950 mm. - A = 220 mm.
Art. 05.044.04 ≡ 20 X 5

H.950 mm.
Art. 05.043.04
 ≡ 20 X 6
 A = 700 mm.

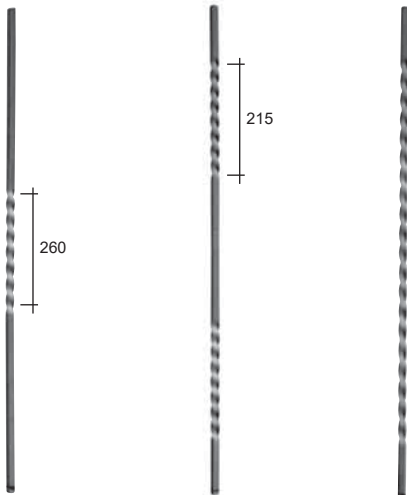

H.950 mm.
Art. 05.045 □ 12
Art. 05.045.01 □ 14
Art. 05.045.02 □ 16

H.950 mm.
Art. 05.046 □ 12
Art. 05.046.01 □ 14
Art. 05.046.02 □ 16

H.750 mm.
Art. 05.047 □ 8
Art. 05.048 □ 10
Art. 05.049 □ 12
Art. 05.050 □ 14
Art. 05.051 □ 16

H.1200 mm.
Art. 05.045.03 □ 12
Art. 05.045.04 □ 14
Art. 05.045.05 □ 16

H.850 mm.
Art. 05.052 □ 8
Art. 05.053 □ 10
Art. 05.054 □ 12
Art. 05.055 □ 14
Art. 05.056 □ 16

H.1500 mm.
Art. 05.045.06 □ 12
Art. 05.045.07 □ 14
Art. 05.045.08 □ 16

H.950 mm.
Art. 05.057 □ 8
Art. 05.058 □ 10
Art. 05.059 □ 12
Art. 05.060 □ 14
Art. 05.061 □ 16



H.950 mm.
Art. 05.062 □ 12



H.950 mm.
Art. 05.063 □ 12



H.950 X L.110 mm.
Art. 05.064
 □ 12 ≡ 12 X 4



H.950 X L.165 mm.
Art. 05.065
 □ 12 ≡ 12 X 6



H.950 X L.165 mm.
Art. 05.066
 □ 12 ≡ 12 X 6

PANNELLI LISCI E PALETTI PER RECINZIONI
PLAIN PANEL UNITS AND STAKES FOR FENCES



H.950 X L.170 mm.
Art. 05.067
 □12 ≄12 X 6



H.950 X L.170 mm.
Art. 05.068
 □12 ≄12 X 6



H.950 X L.110 mm.
Art. 05.069
 □12 ≄12 X 6



H.950 X L.140 mm.
Art. 05.070
 □12 ≄12 X 6



H.950 X L.140 mm.
Art. 05.071
 □12 ≄12 X 6



H.950 X L.155 mm.
Art. 05.071.01
 □12 ≄12 X 6

H.950 X L.155 mm.
Art. 05.071.02
 □14 ≄14 X 6



H.950 X L.155 mm.
Art. 05.071.03
 □12 ≄12 X 6

H.950 X L.155 mm.
Art. 05.071.04
 □14 ≄14 X 6



H.950 X L.220 mm.
Art. 05.072
 □12 ≄12 X 6



H.950 X L.180 mm.
Art. 05.073
 □12 ≄12 X 6



H.950 X L.220 mm.
Art. 05.074
 □12 ≄12 X 6



H.950 X L.170 mm.
Art. 05.075
 □12 ≄12 X 6



H.950 X L.180 mm.
Art. 05.076
 □12 ≄12 X 6



H.1200 X L.185 mm
Art. 05.076.01
 □16 ≄16 X 4



H.950 x L.180 mm
Art. 05.076.02
 □12 mm ≄12 x 6



H.950 X L.220 mm.
Art. 05.077
 □12 ≄12 X 6



H.950 X L.240 mm.
Art. 05.078
 □12 ≄12 X 6



H.950 X L.150 mm.
Art. 05.079
 □12 ≄12 X 6



H.950 X L.220 mm.
Art. 05.080
 □12 ≄12 X 6



H.950 X L.150 mm.
Art. 05.081
 □12 ≄12 X 6



H.950 x L.100 mm
Art. 05.081.50 □14



H.950 X L.220 mm.
Art. 05.082
 □12 ≄12 X 6

Tutte le parti di questo catalogo - foto comprese - sono di proprietà Euro-Fer. La riproduzione, anche parziale, è vietata in ogni forma e con ogni mezzo. / Every part of this catalogue - photos included - is Euro-Fer's property. All forms of copying are strictly prohibited.



H.950 X L.210 mm.
 Art. 05.083
 □12 ≰12 X 4



H.950 X L.210 mm.
 Art. 05.084
 □12 ≰12 X 4



H.950 X L.270 mm.
 Art. 05.085
 □12 ≰12 X 6

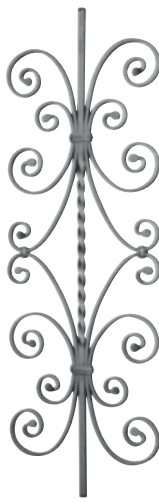

H.950 X L.300 mm.
 Art. 05.086
 □12 ≰12 X 6



H.950 X L.220 mm.
 Art. 05.087
 □12 ≰12 X 6



H.950 X L.275 mm.
 Art. 05.088
 □12 ≰12 X 6



H.950 X L.180 mm.
 Art. 05.088.01
 □12 ≰12 X 6



H.950 X L.220 mm.
 Art. 05.089
 □12 ≰12 X 6

Tutte le parti di questo catalogo - foto comprese - sono di proprietà Euro-Fer. La riproduzione, anche parziale, è vietata in ogni forma e con ogni mezzo. / Every part of this catalogue - photos included - is Euro-Fer's property. All forms of copying are strictly prohibited.

PANNELLI LISCI E PALETTI PER RECINZIONI
PLAIN PANEL UNITS AND STAKES FOR FENCES



H.950 X L.190 mm.
Art. 05.090
 □12 ≙ 12 X 6



H.950 X L.190 mm.
Art. 05.091
 □12 ≙ 12 X 6



H.950 X L.130 mm.
Art. 05.092
 ≙ 40 X 4



H.950 X L.130 mm.
Art. 05.093
 ≙ 40 X 4



Tondo / Round
 H.950 X L.130 mm.
Art. 05.094 ØØ12



Tondo / Round
 H.950 X L.130 mm.
Art. 05.094.01 ØØ12



Tondo / Round
 H.950 X L.130 mm.
Art. 05.094.02 ØØ12



Tondo / Round
 H.950 X L.270 mm.
Art. 05.094.03 ØØ12



Tondo / Round
 H.900 X L.360 mm.
Art. 05.094.04 Ø14



Tondo / Round
 H.900 X L.360 mm.
Art. 05.094.05 Ø14



H.950 X L.125 mm.
Art. 05.095 □ 12



H.800 X L.100 mm.
Art. 05.096 □ 8
Art. 05.097 □ 10
 H.950 X L.100 mm.
Art. 05.098 □ 8
Art. 05.099 □ 10



H.800 X L.100 mm.
Art. 05.100 □ 8
Art. 05.101 □ 10
 H.950 X L.100 mm.
Art. 05.102 □ 8
Art. 05.103 □ 10



H.800 X L.160 mm.
Art. 05.104 □ 8
 H.950 X L.160 mm.
Art. 05.105 □ 8



H.800 X L.110 mm.
Art. 05.106 □ 10



H.800 X L.200 mm.
Art. 05.107 □ 8



H.800 X L.260 mm.
Art. 05.108 □ 8



H.800 X L.140 mm.
Art. 05.109 □ 8
 H.950 X L.140 mm.
Art. 05.110 □ 8



H.800 X L.200 mm.
Art. 05.111 □ 8
 H.950 X L.200 mm.
Art. 05.112 □ 8



H.800 X L.140 mm.
Art. 05.113 □ 8
 H.950 X L.140 mm.
Art. 05.114 □ 8



H.950 X L.240 mm.
Art. 05.115
 □12 ≙ 12 X 6

Tutte le parti di questo catalogo - foto comprese - sono di proprietà Euro-Fer. La riproduzione, anche parziale, è vietata in ogni forma e con ogni mezzo. / Every part of this catalogue - photos included - is Euro-Fer's property. All forms of copying are strictly prohibited.



H.950 X L.160 mm.
Art. 05.116
□ 12 ≙ 12 X 6



H.820 X L.215 mm.
Art. 05.117 □ 8
H.950 X L.215 mm.
Art. 05.118 □ 8



H.820 X L.205 mm.
Art. 05.119 □ 8
H.950 X L.205 mm.
Art. 05.120 □ 8



H.880 X L.150 mm.
Art. 05.121
≙ 12 X 6



H.840 X L.150 mm.
Art. 05.122
≙ 12 X 6



Rigato / Fluted
H.950 x L.240 mm
Art. 05.122.50
□ 12 mm ≙ 12 x 6



Rigato / Fluted
H.950 x L.240 mm
Art. 05.122.51
□ 12 mm ≙ 12 x 6



Liscio / Smooth
H.950 mm
Art. 05.123 □ 12 mm
Art. 05.123.01 □ 14 mm
Art. 05.123.ES □ 12 mm
Art. 05.123.01.ES □ 14 mm
Art. 05.123.02 □ 16 mm
Art. 05.123.02.ES □ 16 mm

.ES = "Modello España"
.ES = "España Model"



Liscio / Smooth
H.950 mm
Art. 05.124 □ 12 mm
Art. 05.124.01 □ 14 mm
Art. 05.124.ES □ 12 mm
Art. 05.124.01.ES □ 14 mm
Art. 05.124.06 □ 16 mm
Art. 05.124.06.ES □ 16 mm



Liscio / Smooth
H.950 mm
Art. 05.124.02 □ 12 mm
H.950 mm
Art. 05.124.03 □ 14 mm
H.950 mm
Art. 05.124.07 □ 16 mm



Liscio / Smooth
H.950 mm
Art. 05.124.04 □ 12 mm
H.950 mm
Art. 05.124.05 □ 14 mm
H.950 mm
Art. 05.124.08 □ 16 mm



H.950 X L.150 mm.
Art. 05.125
□ 12 ≙ 12 X 6



H.950 X L.150 mm.
Art. 05.126
□ 12 ≙ 12 X 6



H.950 X L.220 mm.
Art. 05.127
□ 12 ≙ 12 X 6



H.950 X L.140 mm.
Art. 05.128
□ 12 ≠ 12 X 6



H.950 X L.205 mm.
Art. 05.129
□ 12 ≠ 12 X 6



H.950 X L.170 mm.
Art. 05.130
□ 12 ≠ 12 X 6



H.950 X L.170 mm.
Art. 05.131
□ 12 ≠ 12 X 6



H.950 X L.230 mm.
Art. 05.132
□ 12 ≠ 12 X 6



H.950 X L.185 mm.
Art. 05.133
□ 12 ≠ 12 X 6



H.950 X L.215 mm.
Art. 05.134
□ 12 ≠ 12 X 6



H.950 X L.215 mm.
Art. 05.135
□ 12 ≠ 12 X 6



H.950 X L.215 mm.
Art. 05.136
□ 12 ≠ 12 X 6



Liscio / Smooth
H.950 x L.235 mm
Art. 05.136.01
□ 12 mm ≠ 12 x 6 mm

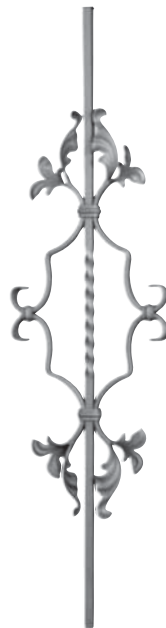

H.950 X L.250 mm.
Art. 05.137
□ 12 ≠ 12 X 6



H.950 X L.250 mm.
Art. 05.138
□ 12 ≠ 12 X 6



H.950 X L.170 mm.
Art. 05.139
□ 12 ≠ 12 X 6



H.950 X L.170 mm.
Art. 05.140
□ 12 ≠ 12 X 6

Tutte le parti di questo catalogo - foto comprese - sono di proprietà Euro-Fer. La riproduzione, anche parziale, è vietata in ogni forma e con ogni mezzo. / Every part of this catalogue - photos included - is Euro-Fer's property. All forms of copying are strictly prohibited.



H.950 X L.260 mm.
Art. 05.141
□ 12 ≙ 12 X 6
Art. 05.141.02
□ 14 ≙ 14 X 6



H.950 X L.230 mm.
Art. 05.141.01
□ 12 ≙ 12 X 6
Art. 05.141.03
□ 14 ≙ 14 X 6



Liscio / Smooth
H.950 x L.280 mm
Art. 05.141.04
□ 12 ≙ 12 x 6



H.860 X L.350 mm.
Art. 05.142 ≙ 12 X 6
Art. 05.142.04 ≙ 14 X 6
Art. 05.142.05 ≙ 16 X 8
Mod. Scala / *Scala Model*
Art. 05.142.06 ≙ 12 X 6
Art. 05.142.07 ≙ 14 X 6
Art. 05.142.08 ≙ 16 X 8



H.860 X L.350 mm.
Art. 05.142.01 ≙ 12 X 6
Art. 05.142.09 ≙ 14 X 6
Art. 05.142.10 ≙ 16 X 8
Mod. Scala / *Scala Model*
Art. 05.142.11 ≙ 12 X 6
Art. 05.142.12 ≙ 14 X 6
Art. 05.142.13 ≙ 16 X 8



H.950 X L.175 mm.
Art. 05.142.02 □ 12
H.950 X L.175 mm.
Art. 05.142.03 □ 14



H.950 X L.260 mm.
Art. 05.143
□ 12 ≙ 12 X 6



Tutte le parti di questo catalogo - foto comprese - sono di proprietà Euro-Fer. La riproduzione, anche parziale, è vietata in ogni forma e con ogni mezzo. / Every part of this catalogue - photos included - is Euro-Fer's property. All forms of copying are strictly prohibited.

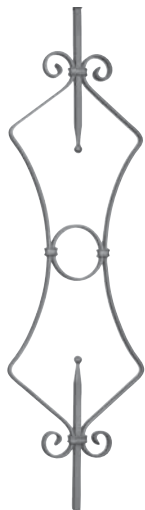

H.950 X L.260 mm.
Art. 05.144
□ 12 ≧ 12 X 6



H.950 X L.260 mm.
Art. 05.145
□ 12 ≧ 12 X 6

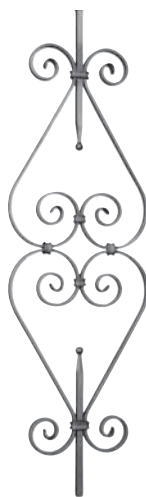

H.950 X L.260 mm.
Art. 05.146
□ 12 ≧ 12 X 6



H.950 X L.290 mm.
Art. 05.147
□ 12 ≧ 12 X 6



H.950 X L.290 mm.
Art. 05.148
□ 12 ≧ 12 X 6



H.950 X L.205 mm.
Art. 05.149
□ 12 ≧ 12 X 6



H.950 X L.140 mm.
Art. 05.149.01
□ 12 ≧ 12 X 6



H.950 X L.190 mm.
Art. 05.150
□ 12 ≧ 12 X 6



H.950 X L.145 mm.
Art. 05.150.01
□ 12 ≧ 12 X 6
Art. 05.150.02
□ 14 ≧ 14 X 6



H.950 X L.95 mm.
Art. 05.151
□ 12 ≧ 12 X 6



H.950 X L.210 mm.
Art. 05.152
□ 12 ≧ 12 X 6



H.950 X L.150 mm.
Art. 05.152.01 □ 8



H.950 X L.205 mm.
Art. 05.153
□ 12 ≧ 12 X 6

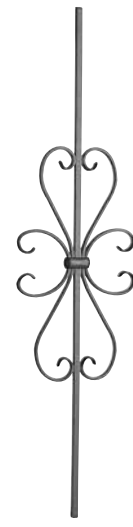

H.950 X L.225 mm.
Art. 05.153.01
□ 12 ≧ 12 X 6



H.950 X L.220 mm.
Art. 05.154
□ 12 ≧ 12 X 6



H.950 X L.230 mm.
Art. 05.154.01
□ 12 ≧ 12 X 6
Art. 05.154.08
□ 14 ≧ 14 X 6



H.950 X L.185 mm.
Art. 05.154.02
□ 14 ≧ 14 X 6



H.950 X L.200 mm.
Art. 05.154.03
□ 12 ≧ 12 X 6
Art. 05.154.09
□ 14 ≧ 14 X 6



H.950 X L.220 mm.
Art. 05.154.04
□ 12 ≧ 12 X 6
Art. 05.154.10
□ 16 ≧ 16 X 8



H.950 X L.205 mm.
Art. 05.154.05
□ 12 ≧ 12 X 6
Art. 05.154.11
□ 16 ≧ 16 X 8

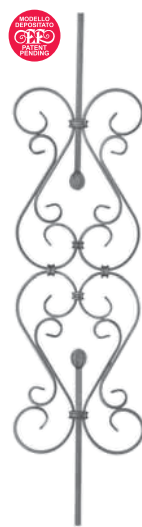

H.950 X L.245 mm.
Art. 05.154.06
□ 12 ≧ 12 X 6



H.830 X L.280 mm.
Art. 05.154.07
≠ 16 X 6



Martellato / *Hammered*
H.950 x L.170 mm
Art. 05.154.12
□ 12 ≠ 12 x 6 mm



Rigato / *Fluted*
H.950 x L.240 mm
Art. 05.154.13
≠ 16 x 8 mm



Rigato / *Fluted*
H.950 x L.360 mm
Art. 05.154.14
□ 16 ≠ 16 x 8 mm

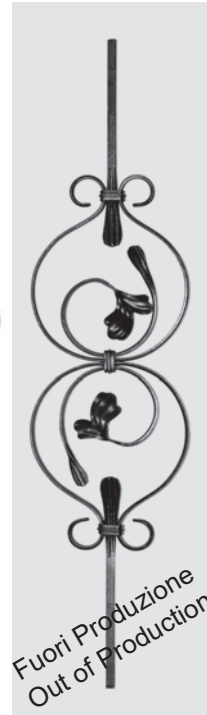

Fuori Produzione
Out of Production

Liscio / *Smooth*
H.950 X L.200 mm
Art. 05.154.15
□ 12 ≠ 12 X 6 mm



Liscio / *Smooth*
H.900 x L.275 mm
Art. 05.154.16
≠ 20 x 6 mm



Rigato / *Fluted*
H.950 x L.190 mm
Art. 05.154.17
≠ 16 x 8 mm



Martellato / *Hammered*
H.950 x L.230 mm
Art. 05.154.18
≠ 16 x 8 mm



Martellato / *Hammered*
H.950 x L.230 mm
Art. 05.154.19
≠ 16 x 8 mm



Liscio / *Smooth*
H.950 x L.180 mm
Art. 05.154.20 □ 12 mm
Con fiori su ambo i lati /
Flowers on both sides



Liscio / *Smooth*
H.950 mm
Art. 05.154.100 □ 12 mm
Art. 05.154.101 □ 14 mm
Art. 05.154.102 □ 16 mm
Art. 05.154.103 □ 18 mm
Art. 05.154.104 □ 20 mm



Liscio / *Smooth*
H.950 mm
Art. 05.154.200 Ø 12 mm
Art. 05.154.201 Ø 14 mm
Art. 05.154.202 Ø 16 mm
Art. 05.154.203 Ø 18 mm
Art. 05.154.204 Ø 20 mm



PANNELLI LISCI E PALETTI PER RECINZIONI
PLAIN PANEL UNITS AND STAKES FOR FENCES



Tondo / Round

- H.950 mm.
 Art. 05.155 Ø 12
 Art. 05.156 Ø 14
 Art. 05.157 Ø 16
 Art. 05.158 Ø 18
 Art. 05.159 Ø 20
- H.1000 mm.
 Art. 05.160 Ø 12
 Art. 05.161 Ø 14
 Art. 05.162 Ø 16
 Art. 05.163 Ø 18
 Art. 05.164 Ø 20
- H.1200 mm.
 Art. 05.165 Ø 12
 Art. 05.166 Ø 14
 Art. 05.167 Ø 16
 Art. 05.168 Ø 18
 Art. 05.169 Ø 20
- H.1500 mm.
 Art. 05.170 Ø 12
 Art. 05.171 Ø 14
 Art. 05.172 Ø 16
 Art. 05.173 Ø 18
 Art. 05.174 Ø 20



- H.950 mm.
 Art. 05.175 □ 12
 Art. 05.176 □ 14
 Art. 05.177 □ 16
 Art. 05.178 □ 18
 Art. 05.179 □ 20
 Art. 05.180 □ 25
 Art. 05.181 □ 30
 Art. 05.182 □ 35
 Art. 05.183 □ 40
- H.1200 mm.
 Art. 05.193 □ 12
 Art. 05.194 □ 14
 Art. 05.195 □ 16
 Art. 05.196 □ 18
 Art. 05.197 □ 20
 Art. 05.198 □ 25
 Art. 05.199 □ 30
 Art. 05.200 □ 35
 Art. 05.201 □ 40
- H.1000 mm.
 Art. 05.184 □ 12
 Art. 05.185 □ 14
 Art. 05.186 □ 16
 Art. 05.187 □ 18
 Art. 05.188 □ 20
 Art. 05.189 □ 25
 Art. 05.190 □ 30
 Art. 05.191 □ 35
 Art. 05.192 □ 40
- H.1500 mm.
 Art. 05.202 □ 12
 Art. 05.203 □ 14
 Art. 05.204 □ 16
 Art. 05.205 □ 18
 Art. 05.206 □ 20
 Art. 05.207 □ 25
 Art. 05.208 □ 30
 Art. 05.209 □ 35
 Art. 05.210 □ 40



Martellato / Hammered

- H.950 mm.
 Art. 05.211 □ 12
 Art. 05.212 □ 14
 Art. 05.213 □ 16
 Art. 05.214 □ 18
 Art. 05.215 □ 20
- H.1000 mm.
 Art. 05.216 □ 12
 Art. 05.217 □ 14
 Art. 05.218 □ 16
 Art. 05.219 □ 18
 Art. 05.220 □ 20
- H.1200 mm.
 Art. 05.221 □ 12
 Art. 05.222 □ 14
 Art. 05.223 □ 16
 Art. 05.224 □ 18
 Art. 05.225 □ 20
- H.1500 mm.
 Art. 05.226 □ 12
 Art. 05.227 □ 14
 Art. 05.228 □ 16
 Art. 05.229 □ 18
 Art. 05.230 □ 20



Tubo / Tube

- H.900 x L.140 mm
 Art. 05.229.01 Ø 20 mm
 H.1150 x L.140 mm
 Art. 05.229.02 Ø 20 mm
 H.1475 x L.140 mm
 Art. 05.229.03 Ø 20 mm
 H.1800 x L.140 mm
 Art. 05.229.04 Ø 20 mm

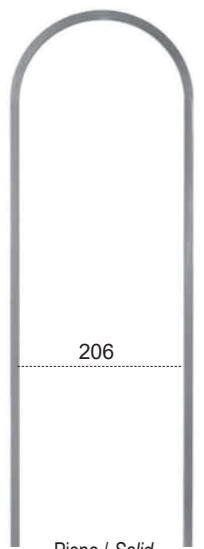

206

Pieno / Solid

- H.1000 X L.124 mm.
 Art. 05.230.01 Ø 12
 H.1000 X L.128 mm.
 Art. 05.230.02 Ø 14
 H.1000 X L.124 mm.
 Art. 05.230.03 □ 12
 H.1000 X L.128 mm.
 Art. 05.230.04 □ 14

Pieno / Solid

- H.1000 X L.230 mm.
 Art. 05.230.05 □ 12
 H.1000 X L.234 mm.
 Art. 05.230.06 □ 14
 H.1000 X L.230 mm.
 Art. 05.230.07 Ø 12
 H.1000 X L.234 mm.
 Art. 05.230.08 Ø 14

Palline Grandi / Large Balls

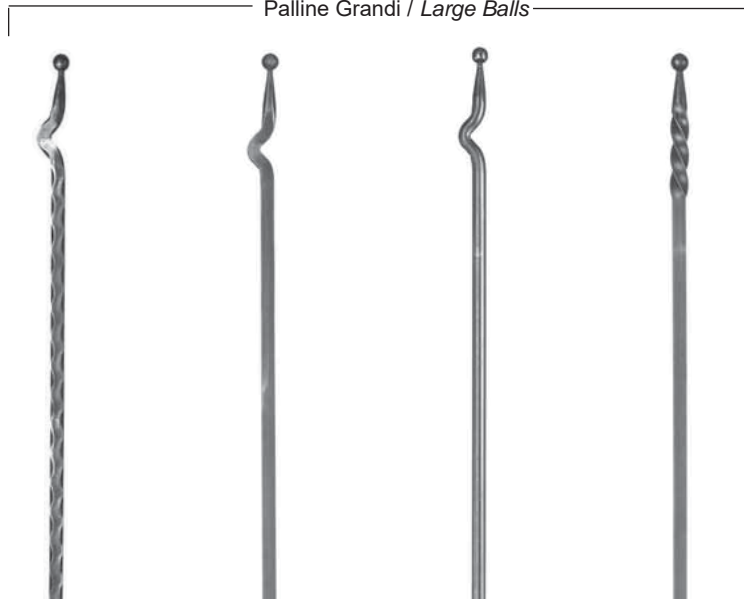

Martellato / Hammered

- H.950 mm.
 Art. 05.230.09 □ 12
 Art. 05.230.10 □ 14
 Art. 05.230.11 □ 16
 Art. 05.230.12 □ 18
- H.1000 mm.
 Art. 05.230.13 □ 12
 Art. 05.230.14 □ 14
 Art. 05.230.15 □ 16
 Art. 05.230.16 □ 18
- H.1200 mm.
 Art. 05.230.17 □ 12
 Art. 05.230.18 □ 14
 Art. 05.230.19 □ 16
 Art. 05.230.20 □ 18
- H.1500 mm.
 Art. 05.230.21 □ 12
 Art. 05.230.22 □ 14
 Art. 05.230.23 □ 16
 Art. 05.230.24 □ 18

- H.950 mm.
 Art. 05.230.25 □ 12
 Art. 05.230.26 □ 14
 Art. 05.230.27 □ 16
 Art. 05.230.28 □ 18
- H.1000 mm.
 Art. 05.230.29 □ 12
 Art. 05.230.30 □ 14
 Art. 05.230.31 □ 16
 Art. 05.230.32 □ 18
- H.1200 mm.
 Art. 05.230.33 □ 12
 Art. 05.230.34 □ 14
 Art. 05.230.35 □ 16
 Art. 05.230.36 □ 18
- H.1500 mm.
 Art. 05.230.37 □ 12
 Art. 05.230.38 □ 14
 Art. 05.230.39 □ 16
 Art. 05.230.40 □ 18

Tondo / Round

- H.950 mm.
 Art. 05.230.41 Ø12
 Art. 05.230.42 Ø14
 Art. 05.230.43 Ø16
 Art. 05.230.44 Ø18
- H.1000 mm.
 Art. 05.230.45 Ø12
 Art. 05.230.46 Ø14
 Art. 05.230.47 Ø16
 Art. 05.230.48 Ø18
- H.1200 mm.
 Art. 05.230.49 Ø12
 Art. 05.230.50 Ø14
 Art. 05.230.51 Ø16
 Art. 05.230.52 Ø18
- H.1500 mm.
 Art. 05.230.53 Ø12
 Art. 05.230.54 Ø14
 Art. 05.230.55 Ø16
 Art. 05.230.56 Ø18

- H.950 mm.
 Art. 05.230.57 □ 12
 Art. 05.230.58 □ 14
 Art. 05.230.59 □ 16
 Art. 05.230.60 □ 18
- H.1000 mm.
 Art. 05.230.61 □ 12
 Art. 05.230.62 □ 14
 Art. 05.230.63 □ 16
 Art. 05.230.64 □ 18
- H.1200 mm.
 Art. 05.230.65 □ 12
 Art. 05.230.66 □ 14
 Art. 05.230.67 □ 16
 Art. 05.230.68 □ 18
- H.1500 mm.
 Art. 05.230.69 □ 12
 Art. 05.230.70 □ 14
 Art. 05.230.71 □ 16
 Art. 05.230.72 □ 18



Tutte le parti di questo catalogo - foto comprese - sono di proprietà Euro-Fer. La riproduzione, anche parziale, è vietata in ogni forma e con ogni mezzo. / Every part of this catalogue - photos included - is Euro-Fer's property. All forms of copying are strictly prohibited.

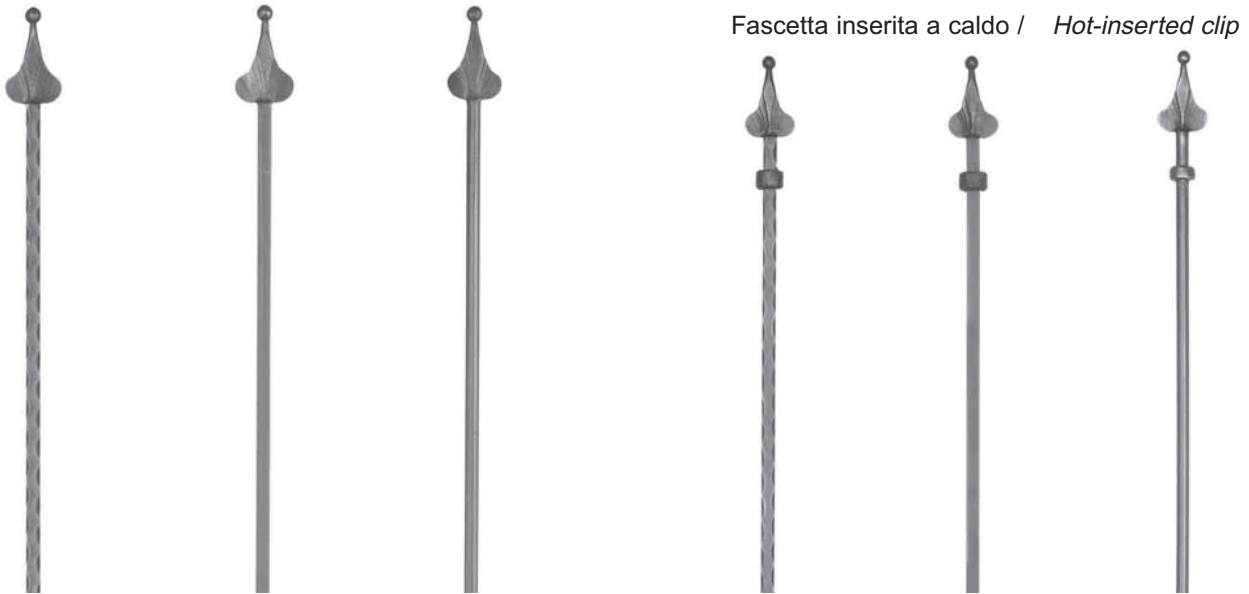

Fascetta inserita a caldo / Hot-inserted clip

Martellato / Hammered

H.950 mm.	
Art. 05.230.73	□ 14
Art. 05.230.74	□ 16
H.1000 mm.	
Art. 05.230.75	□ 14
Art. 05.230.76	□ 16
H.1200 mm.	
Art. 05.230.77	□ 14
Art. 05.230.78	□ 16
H.1500 mm.	
Art. 05.230.79	□ 14
Art. 05.230.80	□ 16
H.2000 mm.	
Art. 05.230.81	□ 14
Art. 05.230.82	□ 16

H.950 mm.	
Art. 05.230.83	□ 14
Art. 05.230.84	□ 16
H.1000 mm.	
Art. 05.230.85	□ 14
Art. 05.230.86	□ 16
H.1200 mm.	
Art. 05.230.87	□ 14
Art. 05.230.88	□ 16
H.1500 mm.	
Art. 05.230.89	□ 14
Art. 05.230.90	□ 16
H.2000 mm.	
Art. 05.230.91	□ 14
Art. 05.230.92	□ 16

Tondo / Round

H.950 mm.	
Art. 05.230.93	Ø14
Art. 05.230.94	Ø16
H.1000 mm.	
Art. 05.230.95	Ø14
Art. 05.230.96	Ø16
H.1200 mm.	
Art. 05.230.97	Ø14
Art. 05.230.98	Ø16
H.1500 mm.	
Art. 05.230.99	Ø14
Art. 05.230.100	Ø16
H.2000 mm.	
Art. 05.230.101	Ø14
Art. 05.230.102	Ø16

Martellato / Hammered

H.950 mm.	
Art. 05.230.103	□ 14
Art. 05.230.104	□ 16
H.1000 mm.	
Art. 05.230.105	□ 14
Art. 05.230.106	□ 16
H.1200 mm.	
Art. 05.230.107	□ 14
Art. 05.230.108	□ 16
H.1500 mm.	
Art. 05.230.109	□ 14
Art. 05.230.110	□ 16
H.2000 mm.	
Art. 05.230.111	□ 14
Art. 05.230.112	□ 16

H.950 mm.	
Art. 05.230.113	□ 14
Art. 05.230.114	□ 16
H.1000 mm.	
Art. 05.230.115	□ 14
Art. 05.230.116	□ 16
H.1200 mm.	
Art. 05.230.117	□ 14
Art. 05.230.118	□ 16
H.1500 mm.	
Art. 05.230.119	□ 14
Art. 05.230.120	□ 16
H.2000 mm.	
Art. 05.230.121	□ 14
Art. 05.230.122	□ 16

Tondo / Round

H.950 mm.	
Art. 05.230.123	Ø14
Art. 05.230.124	Ø16
H.1000 mm.	
Art. 05.230.125	Ø14
Art. 05.230.126	Ø16
H.1200 mm.	
Art. 05.230.127	Ø14
Art. 05.230.128	Ø16
H.1500 mm.	
Art. 05.230.129	Ø14
Art. 05.230.130	Ø16
H.2000 mm.	
Art. 05.230.131	Ø14
Art. 05.230.132	Ø16



Martellato / Hammered

H.1000 mm.	
Art. 05.230.133	□ 14
Art. 05.230.134	□ 16
Art. 05.230.135	□ 18
H.1200 mm.	
Art. 05.230.136	□ 14
Art. 05.230.137	□ 16
Art. 05.230.138	□ 18
H.1500 mm.	
Art. 05.230.139	□ 14
Art. 05.230.140	□ 16
Art. 05.230.141	□ 18

H.1000 mm.	
Art. 05.230.142	□ 14
Art. 05.230.143	□ 16
Art. 05.230.144	□ 18
H.1200 mm.	
Art. 05.230.145	□ 14
Art. 05.230.146	□ 16
Art. 05.230.147	□ 18
H.1500 mm.	
Art. 05.230.148	□ 14
Art. 05.230.149	□ 16
Art. 05.230.150	□ 18

Tondo / Round

H.1000 mm.	
Art. 05.230.151	Ø14
Art. 05.230.152	Ø16
Art. 05.230.153	Ø18
H.1200 mm.	
Art. 05.230.154	Ø14
Art. 05.230.155	Ø16
Art. 05.230.156	Ø18
H.1500 mm.	
Art. 05.230.157	Ø14
Art. 05.230.158	Ø16
Art. 05.230.159	Ø18

Tondo Lavorato
Worked Round Bar

H.1000 mm.	
Art. 05.230.160	Ø14
Art. 05.230.161	Ø16
Art. 05.230.162	Ø18
H.1200 mm.	
Art. 05.230.163	Ø14
Art. 05.230.164	Ø16
Art. 05.230.165	Ø18
H.1500 mm.	
Art. 05.230.166	Ø14
Art. 05.230.167	Ø16
Art. 05.230.168	Ø18

Liscio / Smooth	
H.950 x L.120 mm	
Art. 05.230.169	□ 12

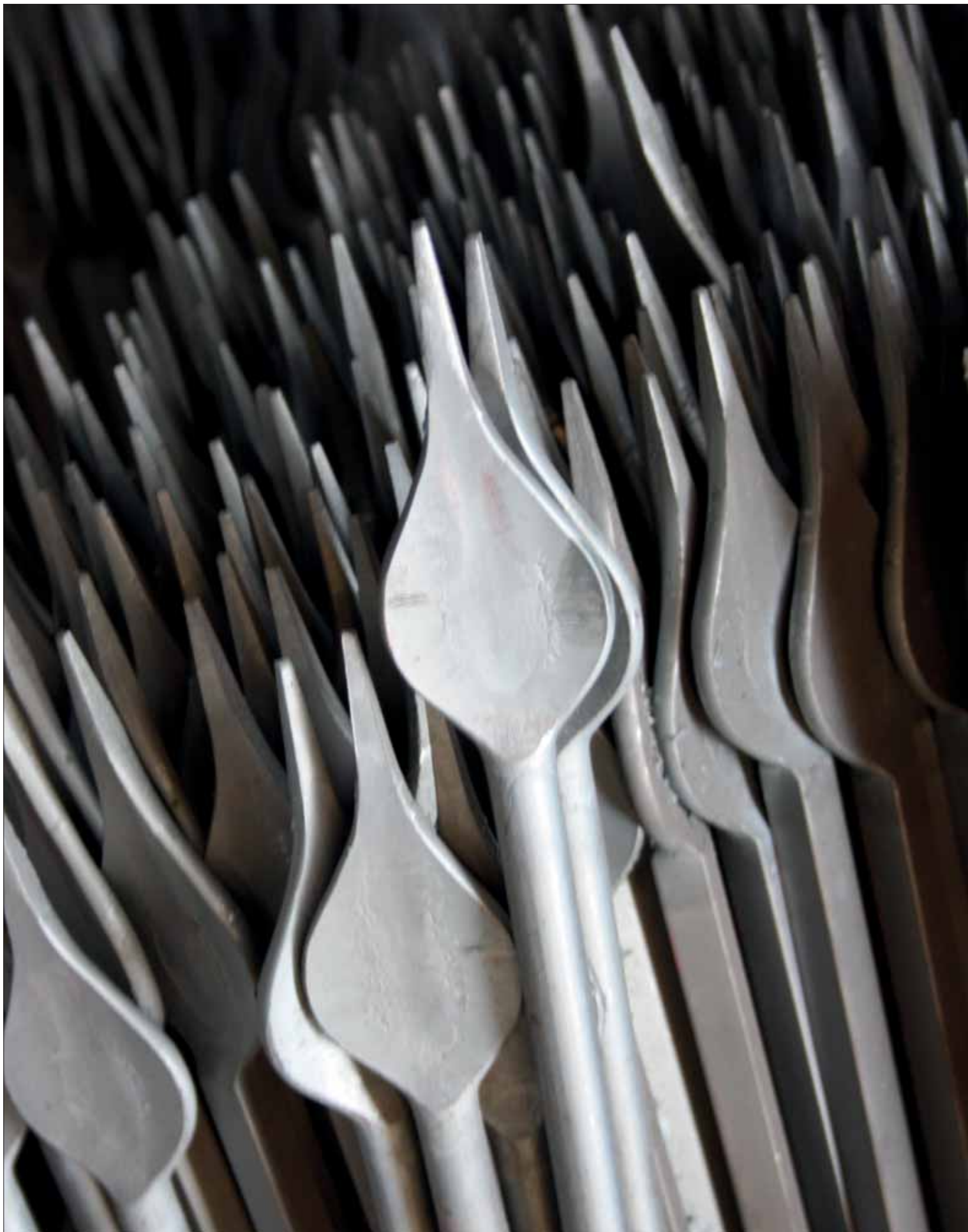

Tutte le parti di questo catalogo - foto comprese - sono di proprietà Euro-Fer. La riproduzione, anche parziale, è vietata in ogni forma e con ogni mezzo. / Every part of this catalogue - photos included - is Euro-Fer's property. All forms of copying are strictly prohibited.

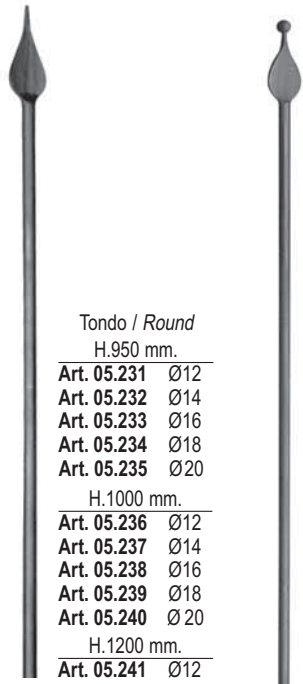

- Tondo / Round*
H.950 mm.
- Art. 05.231 Ø12
 - Art. 05.232 Ø14
 - Art. 05.233 Ø16
 - Art. 05.234 Ø18
 - Art. 05.235 Ø20
- H.1000 mm.
- Art. 05.236 Ø12
 - Art. 05.237 Ø14
 - Art. 05.238 Ø16
 - Art. 05.239 Ø18
 - Art. 05.240 Ø20
- H.1200 mm.
- Art. 05.241 Ø12
 - Art. 05.242 Ø14
 - Art. 05.243 Ø16
 - Art. 05.244 Ø18
 - Art. 05.245 Ø20
- H.1500 mm.
- Art. 05.246 Ø12
 - Art. 05.247 Ø14
 - Art. 05.248 Ø16
 - Art. 05.249 Ø18
 - Art. 05.250 Ø20

- Tondo / Round*
H.950 mm.
- Art. 05.231.01 Ø12
 - Art. 05.232.01 Ø14
 - Art. 05.233.01 Ø16
- H.1000 mm.
- Art. 05.236.01 Ø12
 - Art. 05.237.01 Ø14
 - Art. 05.238.01 Ø16
- H.1200 mm.
- Art. 05.241.01 Ø12
 - Art. 05.242.01 Ø14
 - Art. 05.243.01 Ø16
 - Art. 05.245.01 Ø20
- H.1500 mm.
- Art. 05.246.01 Ø12
 - Art. 05.247.01 Ø14
 - Art. 05.248.01 Ø16

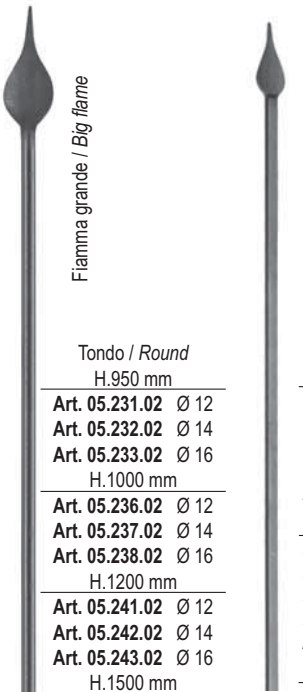

- Fiamma grande / Big flame*
- Tondo / Round*
H.950 mm
- Art. 05.231.02 Ø 12
 - Art. 05.232.02 Ø 14
 - Art. 05.233.02 Ø 16
- H.1000 mm
- Art. 05.236.02 Ø 12
 - Art. 05.237.02 Ø 14
 - Art. 05.238.02 Ø 16
- H.1200 mm
- Art. 05.241.02 Ø 12
 - Art. 05.242.02 Ø 14
 - Art. 05.243.02 Ø 16
- H.1500 mm
- Art. 05.246.02 Ø 12
 - Art. 05.247.02 Ø 14
 - Art. 05.248.02 Ø 16

- H.950 mm.
- Art. 05.251 □ 12
 - Art. 05.252 □ 14
 - Art. 05.253 □ 16
 - Art. 05.254 □ 18
 - Art. 05.255 □ 20
- H.1000 mm.
- Art. 05.256 □ 12
 - Art. 05.257 □ 14
 - Art. 05.258 □ 16
 - Art. 05.259 □ 18
 - Art. 05.260 □ 20
- H.1200 mm.
- Art. 05.261 □ 12
 - Art. 05.262 □ 14
 - Art. 05.263 □ 16
 - Art. 05.264 □ 18
 - Art. 05.265 □ 20
- H.1500 mm.
- Art. 05.266 □ 12
 - Art. 05.267 □ 14
 - Art. 05.268 □ 16
 - Art. 05.269 □ 18
 - Art. 05.270 □ 20

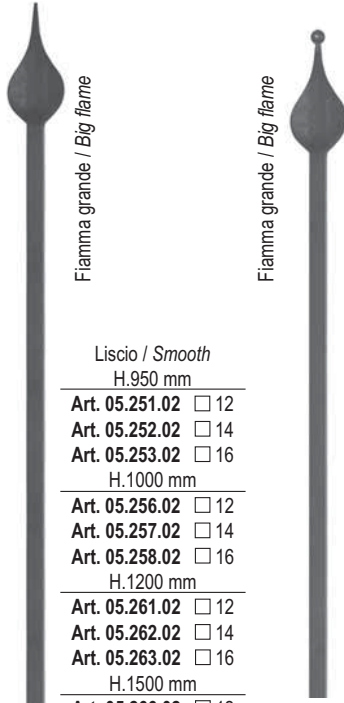

- Fiamma grande / Big flame*
- Liscio / Smooth*
H.950 mm
- Art. 05.251.02 □ 12
 - Art. 05.252.02 □ 14
 - Art. 05.253.02 □ 16
 - Art. 05.254.02 □ 18
 - Art. 05.255.02 □ 20
- H.1000 mm
- Art. 05.256.02 □ 12
 - Art. 05.257.02 □ 14
 - Art. 05.258.02 □ 16
- H.1200 mm
- Art. 05.261.02 □ 12
 - Art. 05.262.02 □ 14
 - Art. 05.263.02 □ 16
- H.1500 mm
- Art. 05.266.02 □ 12
 - Art. 05.267.02 □ 14
 - Art. 05.268.02 □ 16

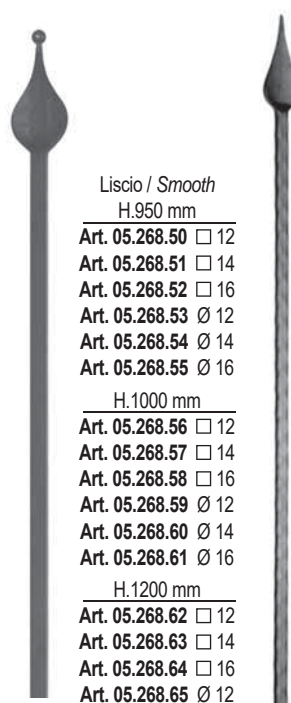

- Fiamma grande / Big flame*
- Liscio / Smooth*
H.950 mm
- Art. 05.268.50 □ 12
 - Art. 05.268.51 □ 14
 - Art. 05.268.52 □ 16
 - Art. 05.268.53 Ø 12
 - Art. 05.268.54 Ø 14
 - Art. 05.268.55 Ø 16
- H.1000 mm
- Art. 05.268.56 □ 12
 - Art. 05.268.57 □ 14
 - Art. 05.268.58 □ 16
 - Art. 05.268.59 Ø 12
 - Art. 05.268.60 Ø 14
 - Art. 05.268.61 Ø 16
- H.1200 mm
- Art. 05.268.62 □ 12
 - Art. 05.268.63 □ 14
 - Art. 05.268.64 □ 16
 - Art. 05.268.65 Ø 12
 - Art. 05.268.66 Ø 14
 - Art. 05.268.67 Ø 16
- H.1500 mm
- Art. 05.268.68 □ 12
 - Art. 05.268.69 □ 14
 - Art. 05.268.70 □ 16
 - Art. 05.268.71 Ø 12
 - Art. 05.268.72 Ø 14
 - Art. 05.268.73 Ø 16

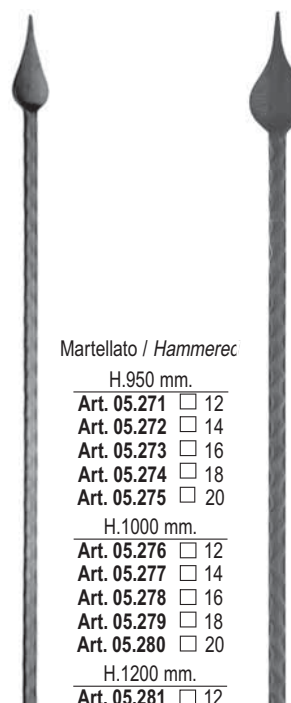

- Martellato / Hammerec*
H.950 mm.
- Art. 05.271 □ 12
 - Art. 05.272 □ 14
 - Art. 05.273 □ 16
 - Art. 05.274 □ 18
 - Art. 05.275 □ 20
- H.1000 mm.
- Art. 05.276 □ 12
 - Art. 05.277 □ 14
 - Art. 05.278 □ 16
 - Art. 05.279 □ 18
 - Art. 05.280 □ 20
- H.1200 mm.
- Art. 05.281 □ 12
 - Art. 05.282 □ 14
 - Art. 05.283 □ 16
 - Art. 05.284 □ 18
 - Art. 05.285 □ 20
- H.1500 mm.
- Art. 05.286 □ 12
 - Art. 05.287 □ 14
 - Art. 05.288 □ 16
 - Art. 05.289 □ 18
 - Art. 05.290 □ 20

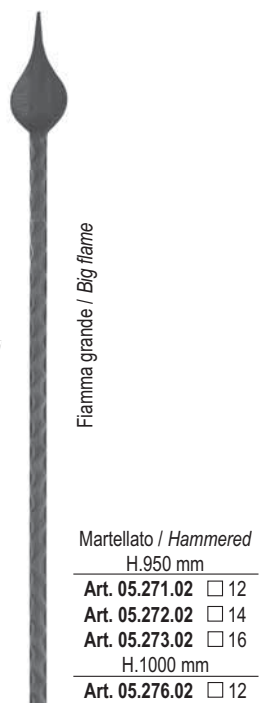

- Fiamma grande / Big flame*
- Martellato / Hammered*
H.950 mm
- Art. 05.271.02 □ 12
 - Art. 05.272.02 □ 14
 - Art. 05.273.02 □ 16
- H.1000 mm
- Art. 05.276.02 □ 12
 - Art. 05.277.02 □ 14
 - Art. 05.278.02 □ 16
- H.1200 mm
- Art. 05.281.02 □ 12
 - Art. 05.282.02 □ 14
 - Art. 05.283.02 □ 16
- H.1500 mm
- Art. 05.286.02 □ 12
 - Art. 05.287.02 □ 14
 - Art. 05.288.02 □ 16



Schiacciata sullo spigolo /
Ornament on the edge

Liscio / Smooth
H.950 mm

Art. 05.289.01 12
Art. 05.289.02 14
Art. 05.289.03 16

H.1000 mm

Art. 05.289.04 12
Art. 05.289.05 14
Art. 05.289.06 16

H.1200 mm

Art. 05.289.07 12
Art. 05.289.08 14
Art. 05.289.09 16

H.1500 mm

Art. 05.289.10 12
Art. 05.289.11 14
Art. 05.289.12 16



Martellato / Hammered
H.950 mm

Art. 05.290.01 12
Art. 05.290.02 14
Art. 05.290.03 16

H.1000 mm

Art. 05.290.04 12
Art. 05.290.05 14
Art. 05.290.06 16

H.1200 mm

Art. 05.290.07 12
Art. 05.290.08 14
Art. 05.290.09 16

H.1500 mm

Art. 05.290.10 12
Art. 05.290.11 14
Art. 05.290.12 16



Liscio / Smooth
H.950 mm

Art. 05.290.13 12
Art. 05.290.14 14
Art. 05.290.15 16

H.1000 mm

Art. 05.290.16 12
Art. 05.290.17 14
Art. 05.290.18 16

H.1200 mm

Art. 05.290.19 12
Art. 05.290.20 14
Art. 05.290.21 16

H.1500 mm

Art. 05.290.22 12
Art. 05.290.23 14
Art. 05.290.24 16



H.950 mm.

Art. 05.291 12
Art. 05.292 14
Art. 05.293 16

H.1000 mm.

Art. 05.294 12
Art. 05.295 14
Art. 05.296 16

H.1200 mm.

Art. 05.297 12
Art. 05.298 14
Art. 05.299 16

H.1500 mm.

Art. 05.300 12
Art. 05.301 14
Art. 05.302 16



H.950 mm.

Art. 05.303 12
Art. 05.304 14
Art. 05.305 16
Art. 05.306 18
Art. 05.307 20

H.1000 mm.

Art. 05.308 12
Art. 05.309 14
Art. 05.310 16
Art. 05.311 18
Art. 05.312 20

H.1200 mm.

Art. 05.313 12
Art. 05.314 14
Art. 05.315 16
Art. 05.316 18
Art. 05.317 20

H.1500 mm.

Art. 05.318 12
Art. 05.319 14
Art. 05.320 16
Art. 05.321 18
Art. 05.322 20



H.950 mm.

Art. 05.323 12
Art. 05.324 14
Art. 05.325 16
Art. 05.326 18
Art. 05.327 20

H.1000 mm.

Art. 05.328 12
Art. 05.329 14
Art. 05.330 16
Art. 05.331 18
Art. 05.332 20

H.1200 mm.

Art. 05.333 12
Art. 05.334 14
Art. 05.335 16
Art. 05.336 18
Art. 05.337 20

H.1500 mm.

Art. 05.338 12
Art. 05.339 14
Art. 05.340 16
Art. 05.341 18
Art. 05.342 20



Liscio / Smooth
H.950 mm

Art. 05.342.20 12
Art. 05.342.21 14

H.1000 mm

Art. 05.342.22 12
Art. 05.342.23 14

H.1200 mm

Art. 05.342.24 12
Art. 05.342.25 14

H.1500 mm

Art. 05.342.26 12
Art. 05.342.27 14



Liscio
≠ 25 x 8 mm

Art. 05.342.100 H.950
Art. 05.342.101 H.1000
Art. 05.342.102 H.1200
Art. 05.342.103 H.1500

Liscio
≠ 30 x 8 mm

Art. 05.342.104 H.950
Art. 05.342.105 H.1000
Art. 05.342.106 H.1200
Art. 05.342.107 H.1500



Martellato / Hammered

H.950 mm.

Art. 05.343 12
Art. 05.344 14

H.1000 mm.

Art. 05.345 12
Art. 05.346 14

H.1200 mm.

Art. 05.347 12
Art. 05.348 14

H.1500 mm.

Art. 05.349 12
Art. 05.350 14



Liscio / Smooth
H 950 mm

Art. 05.350.100 Ø12
Art. 05.350.101 Ø14

H 1000 mm

Art. 05.350.103 Ø12
Art. 05.350.104 Ø14



Liscio / Smooth
H 950 mm

Art. 05.350.125 12
Art. 05.350.126 14
Art. 05.350.127 16

H 1000 mm

Art. 05.350.130 12
Art. 05.350.131 14
Art. 05.350.132 16

PALLINE GRANDI / LARGE BALLS

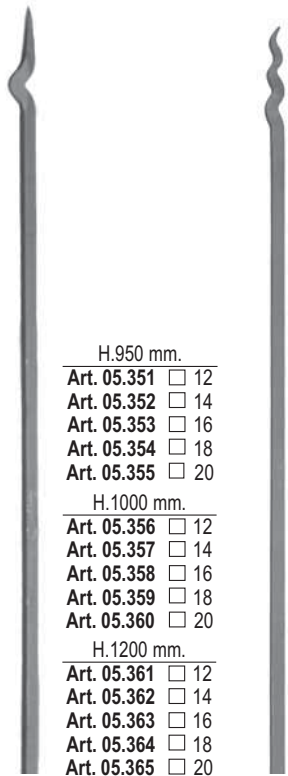

- H.950 mm.
Art. 05.351 □ 12
Art. 05.352 □ 14
Art. 05.353 □ 16
Art. 05.354 □ 18
Art. 05.355 □ 20
- H.1000 mm.
Art. 05.356 □ 12
Art. 05.357 □ 14
Art. 05.358 □ 16
Art. 05.359 □ 18
Art. 05.360 □ 20
- H.1200 mm.
Art. 05.361 □ 12
Art. 05.362 □ 14
Art. 05.363 □ 16
Art. 05.364 □ 18
Art. 05.365 □ 20
- H.1500 mm.
Art. 05.366 □ 12
Art. 05.367 □ 14
Art. 05.368 □ 16
Art. 05.369 □ 18
Art. 05.370 □ 20

- H.950 mm.
Art. 05.371 □ 12
Art. 05.372 □ 14
Art. 05.373 □ 16
Art. 05.374 □ 18
Art. 05.375 □ 20
- H.1000 mm.
Art. 05.376 □ 12
Art. 05.377 □ 14
Art. 05.378 □ 16
Art. 05.379 □ 18
Art. 05.380 □ 20
- H.1200 mm.
Art. 05.381 □ 12
Art. 05.382 □ 14
Art. 05.383 □ 16
Art. 05.384 □ 18
Art. 05.385 □ 20
- H.1500 mm.
Art. 05.386 □ 12
Art. 05.387 □ 14
Art. 05.388 □ 16
Art. 05.389 □ 18
Art. 05.390 □ 20



Martellato / Hammered

Martellato / Hammered

- H.950 mm.
Art. 05.390.01 □ 12
Art. 05.390.02 □ 14
- H.1000 mm.
Art. 05.390.03 □ 12
Art. 05.390.04 □ 14
- H.1200 mm.
Art. 05.390.05 □ 12
Art. 05.390.06 □ 14
- H.1500 mm.
Art. 05.390.07 □ 12
Art. 05.390.08 □ 14

- H.950 mm.
Art. 05.390.09 □ 12
Art. 05.390.10 □ 14
- H.1000 mm.
Art. 05.390.11 □ 12
Art. 05.390.12 □ 14
- H.1200 mm.
Art. 05.390.13 □ 12
Art. 05.390.14 □ 14
- H.1500 mm.
Art. 05.390.15 □ 12
Art. 05.390.16 □ 14

- H.950 mm.
Art. 05.399 □ 12
Art. 05.400 □ 14
- H.1000 mm.
Art. 05.401 □ 12
Art. 05.402 □ 14
- H.1200 mm.
Art. 05.403 □ 12
Art. 05.404 □ 14
- H.1500 mm.
Art. 05.405 □ 12
Art. 05.406 □ 14

- H.950 mm.
Art. 05.407 □ 12
Art. 05.408 □ 14
- H.1000 mm.
Art. 05.409 □ 12
Art. 05.410 □ 14
- H.1200 mm.
Art. 05.411 □ 12
Art. 05.412 □ 14
- H.1500 mm.
Art. 05.413 □ 12
Art. 05.414 □ 14

Tondo / Round

- H.950 mm.
Art. 05.414.01 Ø12
Art. 05.414.02 Ø14
Art. 05.414.03 Ø16
- H.1000 mm.
Art. 05.414.04 Ø12
Art. 05.414.05 Ø14
Art. 05.414.06 Ø16
- H.1200 mm.
Art. 05.414.07 Ø12
Art. 05.414.08 Ø14
Art. 05.414.09 Ø16
- H.1500 mm.
Art. 05.414.10 Ø12
Art. 05.414.11 Ø14
Art. 05.414.12 Ø16

PALLINE GRANDI / LARGE BALLS

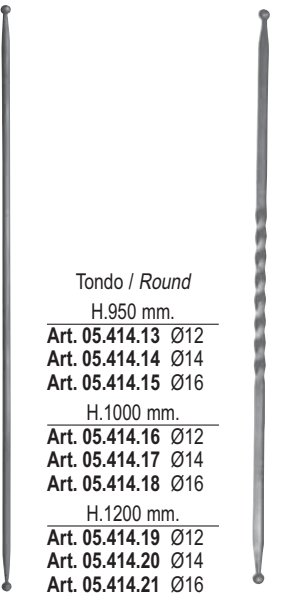

Tondo / Round

- H.950 mm.
Art. 05.414.13 Ø12
Art. 05.414.14 Ø14
Art. 05.414.15 Ø16
- H.1000 mm.
Art. 05.414.16 Ø12
Art. 05.414.17 Ø14
Art. 05.414.18 Ø16
- H.1200 mm.
Art. 05.414.19 Ø12
Art. 05.414.20 Ø14
Art. 05.414.21 Ø16
- H.1500 mm.
Art. 05.414.22 Ø12
Art. 05.414.23 Ø14
Art. 05.414.24 Ø16

- H.950 mm.
Art. 05.415 □ 12
Art. 05.416 □ 14
- H.1000 mm.
Art. 05.417 □ 12
Art. 05.418 □ 14
- H.1200 mm.
Art. 05.419 □ 12
Art. 05.420 □ 14
- H.1500 mm.
Art. 05.421 □ 12
Art. 05.422 □ 14

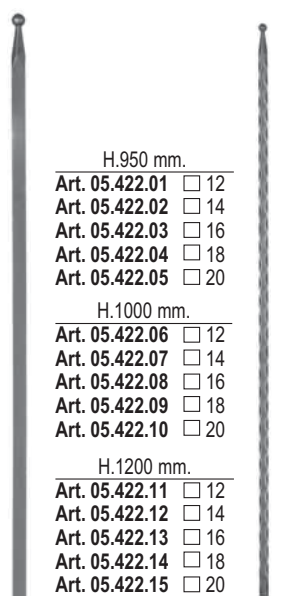

Martellato / Hammered

- H.950 mm.
Art. 05.422.01 □ 12
Art. 05.422.02 □ 14
Art. 05.422.03 □ 16
Art. 05.422.04 □ 18
Art. 05.422.05 □ 20
- H.1000 mm.
Art. 05.422.06 □ 12
Art. 05.422.07 □ 14
Art. 05.422.08 □ 16
Art. 05.422.09 □ 18
Art. 05.422.10 □ 20
- H.1200 mm.
Art. 05.422.11 □ 12
Art. 05.422.12 □ 14
Art. 05.422.13 □ 16
Art. 05.422.14 □ 18
Art. 05.422.15 □ 20
- H.1500 mm.
Art. 05.422.16 □ 12
Art. 05.422.17 □ 14
Art. 05.422.18 □ 16
Art. 05.422.19 □ 18
Art. 05.422.20 □ 20

- H.950 mm.
Art. 05.422.21 □ 12
Art. 05.422.22 □ 14
Art. 05.422.23 □ 16
Art. 05.422.24 □ 18
Art. 05.422.25 □ 20
- H.1000 mm.
Art. 05.422.26 □ 12
Art. 05.422.27 □ 14
Art. 05.422.28 □ 16
Art. 05.422.29 □ 18
Art. 05.422.30 □ 20
- H.1200 mm.
Art. 05.422.31 □ 12
Art. 05.422.32 □ 14
Art. 05.422.33 □ 16
Art. 05.422.34 □ 18
Art. 05.422.35 □ 20
- H.1500 mm.
Art. 05.422.36 □ 12
Art. 05.422.37 □ 14
Art. 05.422.38 □ 16
Art. 05.422.39 □ 18
Art. 05.422.40 □ 20

Tondo / Round

- H.950 mm.
Art. 05.422.41 Ø12
Art. 05.422.42 Ø14
Art. 05.422.43 Ø16
Art. 05.422.44 Ø18
- H.1000 mm.
Art. 05.422.45 Ø12
Art. 05.422.46 Ø14
Art. 05.422.47 Ø16
Art. 05.422.48 Ø18
- H.1200 mm.
Art. 05.422.49 Ø12
Art. 05.422.50 Ø14
Art. 05.422.51 Ø16
Art. 05.422.52 Ø18
- H.1500 mm.
Art. 05.422.53 Ø12
Art. 05.422.54 Ø14
Art. 05.422.55 Ø16
Art. 05.422.56 Ø18

- H.950 mm.
Art. 05.422.57 □ 12
Art. 05.422.58 □ 14
Art. 05.422.59 □ 16
Art. 05.422.60 □ 18
Art. 05.422.61 □ 20
- H.1000 mm.
Art. 05.422.62 □ 12
Art. 05.422.63 □ 14
Art. 05.422.64 □ 16
Art. 05.422.65 □ 18
Art. 05.422.66 □ 20
- H.1200 mm.
Art. 05.422.67 □ 12
Art. 05.422.68 □ 14
Art. 05.422.69 □ 16
Art. 05.422.70 □ 18
Art. 05.422.71 □ 20
- H.1500 mm.
Art. 05.422.72 □ 12
Art. 05.422.73 □ 14
Art. 05.422.74 □ 16
Art. 05.422.75 □ 18
Art. 05.422.76 □ 20

PALLINE PICCOLE / SMALL BALLS

PALLINE PICCOLE / SMALL BALLS



H.950 mm.
Art. 05.422.77 12
Art. 05.422.78 14
Art. 05.422.79 16

Martellato / *Hammered*
H.950 mm.
Art. 05.422.80 12
Art. 05.422.81 14
Art. 05.422.82 16

Tondo / *Round*
H.950 mm.
Art. 05.422.83 Ø14
Art. 05.422.84 Ø16

H.950 mm.
Art. 05.422.85 12
Art. 05.422.86 14
Art. 05.422.87 16

Martellato / *Hammered*
H.950 mm.
Art. 05.422.88 12
Art. 05.422.89 14
Art. 05.422.90 16

Tondo / *Round*
H.950 mm.
Art. 05.422.91 Ø14
Art. 05.422.92 Ø16

H.950 mm.
Art. 05.422.93 12
Art. 05.422.94 14
Art. 05.422.95 16

PALLINE PICCOLE / SMALL BALLS

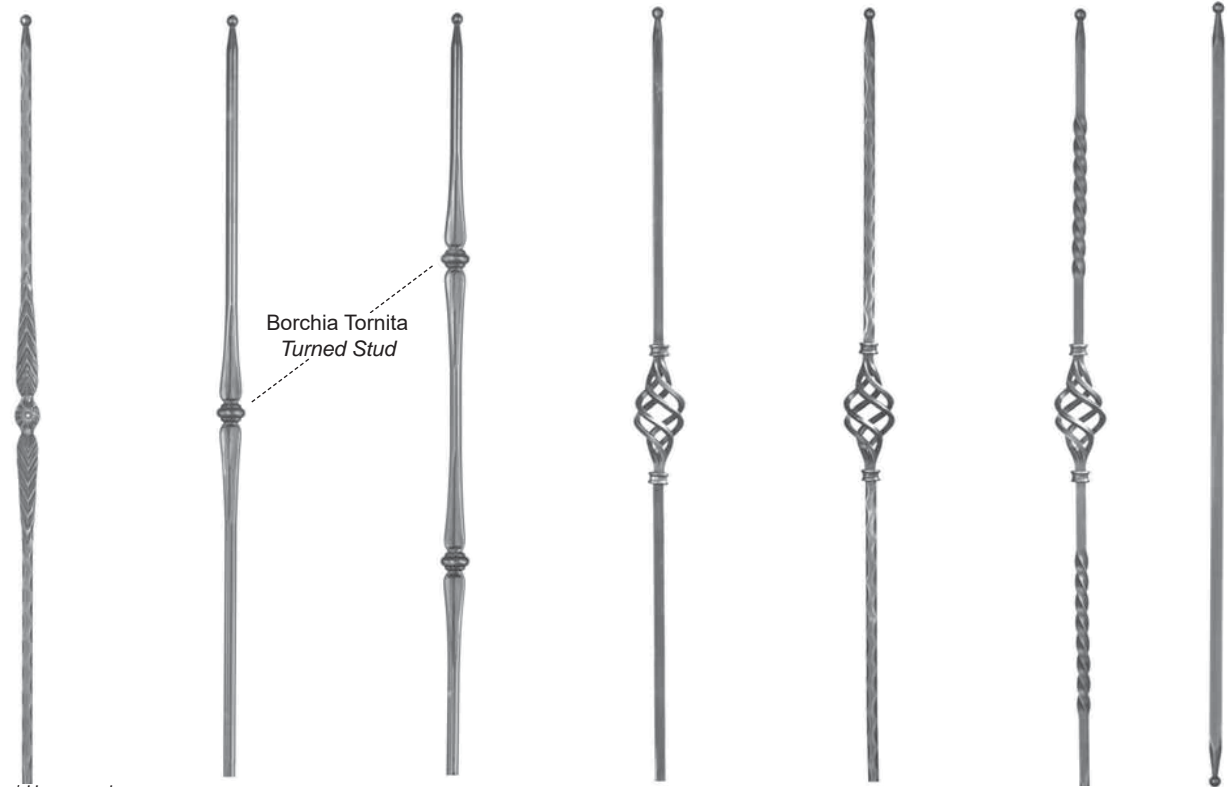

Martellato / *Hammered*
H.950 mm.
Art. 05.422.96 12
Art. 05.422.97 14
Art. 05.422.98 16

Tondo / *Round*
H.950 mm.
Art. 05.422.99 Ø12
Art. 05.422.100 Ø14

Borchia Tornita
Turned Stud

Tondo / *Round*
H.950 mm.
Art. 05.422.101 Ø12
Art. 05.422.102 Ø14

H.950 mm.
Art. 05.422.103 12
Art. 05.422.104 14

Martellato / *Hammered*
H.950 mm.
Art. 05.422.105 12
Art. 05.422.106 14

H.950 mm.
Art. 05.422.107 12
Art. 05.422.108 14

H.950 mm.
Art. 05.422.109 12
Art. 05.422.110 14
Art. 05.422.111 16
Art. 05.422.112 18
Art. 05.422.113 20

H.1000 mm.
Art. 05.422.114 12
Art. 05.422.115 14
Art. 05.422.116 16
Art. 05.422.117 18
Art. 05.422.118 20

H.1200 mm.
Art. 05.422.119 12
Art. 05.422.120 14
Art. 05.422.121 16
Art. 05.422.122 18
Art. 05.422.123 20

H.1500 mm.
Art. 05.422.124 12
Art. 05.422.125 14
Art. 05.422.126 16
Art. 05.422.127 18
Art. 05.422.128 20

Tutte le parti di questo catalogo - foto comprese - sono di proprietà Euro-Fer. La riproduzione, anche parziale, è vietata in ogni forma e con ogni mezzo. / Every part of this catalogue - photos included - is Euro-Fer's property. All forms of copying are strictly prohibited.



Martellato / *Hammered*

- H.950 mm.
Art. 05.422.129 □12
Art. 05.422.130 □14
Art. 05.422.131 □16
Art. 05.422.132 □18
Art. 05.422.133 □20
- H.1000 mm.
Art. 05.422.134 □12
Art. 05.422.135 □14
Art. 05.422.136 □16
Art. 05.422.137 □18
Art. 05.422.138 □20
- H.1200 mm.
Art. 05.422.139 □12
Art. 05.422.140 □14
Art. 05.422.141 □16
Art. 05.422.142 □18
Art. 05.422.143 □20
- H.1500 mm.
Art. 05.422.144 □12
Art. 05.422.145 □14
Art. 05.422.146 □16
Art. 05.422.147 □18
Art. 05.422.148 □20



Tondo / *Round*

- H.950 mm.
Art. 05.422.149 Ø12
Art. 05.422.150 Ø14
Art. 05.422.151 Ø16
Art. 05.422.152 Ø18
- H.1000 mm.
Art. 05.422.153 Ø12
Art. 05.422.154 Ø14
Art. 05.422.155 Ø16
Art. 05.422.156 Ø18
- H.1200 mm.
Art. 05.422.157 Ø12
Art. 05.422.158 Ø14
Art. 05.422.159 Ø16
Art. 05.422.160 Ø18
- H.1500 mm.
Art. 05.422.161 Ø12
Art. 05.422.162 Ø14
Art. 05.422.163 Ø16
Art. 05.422.164 Ø18



H.950 mm.

- Art. 05.422.165 □12
Art. 05.422.166 □14
Art. 05.422.167 □16
Art. 05.422.168 □18
Art. 05.422.169 □20
- H.1000 mm.
Art. 05.422.170 □12
Art. 05.422.171 □14
Art. 05.422.172 □16
Art. 05.422.173 □18
Art. 05.422.174 □20
- H.1200 mm.
Art. 05.422.175 □12
Art. 05.422.176 □14
Art. 05.422.177 □16
Art. 05.422.178 □18
Art. 05.422.179 □20
- H.1500 mm.
Art. 05.422.180 □12
Art. 05.422.181 □14
Art. 05.422.182 □16
Art. 05.422.183 □18
Art. 05.422.184 □20



H.950 mm.

- Art. 05.422.185 □12
Art. 05.422.186 □14
Art. 05.422.187 □16



Martellato / *Hammered*

- H.950 mm.
Art. 05.422.188 □12
Art. 05.422.189 □14
Art. 05.422.190 □16



Tondo / *Round*

- H.950 mm.
Art. 05.422.191 Ø14
Art. 05.422.192 Ø16



H.950 mm.

- Art. 05.422.193 □12
Art. 05.422.194 □14
Art. 05.422.195 □16



Martellato / *Hammered*

- H.950 mm.
Art. 05.422.196 □12
Art. 05.422.197 □14
Art. 05.422.198 □16



Tondo / *Round*

- H.950 mm.
Art. 05.422.199 Ø14
Art. 05.422.200 Ø16



H.950 mm.

- Art. 05.422.201 □12
Art. 05.422.202 □14
Art. 05.422.203 □16



Martellato / *Hammered*

- H.950 mm.
Art. 05.422.204 □12
Art. 05.422.205 □14
Art. 05.422.206 □16



Tondo / *Round*

- H.950 mm.
Art. 05.422.207 Ø12
Art. 05.422.208 Ø14



Tondo / *Round*

- H.950 mm.
Art. 05.422.209 Ø12
Art. 05.422.210 Ø14

Borchia Tornita
Turned Stud

PANNELLI LISCI E PALETTI PER RECINZIONI
PLAIN PANEL UNITS AND STAKES FOR FENCES



H.950 mm.
 Art. 05.422.211 12
 Art. 05.422.212 14



Martellato / *Hammered*
 H.950 mm.
 Art. 05.422.213 12
 Art. 05.422.214 14



H.950 mm.
 Art. 05.422.215 12
 Art. 05.422.216 14



Pallina piccola / Small ball
 Liscio / Smooth

H.950 mm
 Art. 05.422.250 12 mm
 Art. 05.422.251 14 mm
 Art. 05.422.252 16 mm

H.1000 mm
 Art. 05.422.253 12 mm
 Art. 05.422.254 14 mm
 Art. 05.422.255 16 mm

H.1200 mm
 Art. 05.422.256 12 mm
 Art. 05.422.257 14 mm
 Art. 05.422.258 16 mm

H.1500 mm
 Art. 05.422.259 12 mm
 Art. 05.422.260 14 mm
 Art. 05.422.261 16 mm



Pallina piccola / Small ball
 Martellato / Hammered

H.950 mm
 Art. 05.422.300 12 mm
 Art. 05.422.301 14 mm
 Art. 05.422.302 16 mm

H.1000 mm
 Art. 05.422.303 12 mm
 Art. 05.422.304 14 mm
 Art. 05.422.305 16 mm

H.1200 mm
 Art. 05.422.306 12 mm
 Art. 05.422.307 14 mm
 Art. 05.422.308 16 mm

H.1500 mm
 Art. 05.422.309 12 mm
 Art. 05.422.310 14 mm
 Art. 05.422.311 16 mm



Liscio / Smooth
 H.1000 mm
 Art. 05.427.01 Ø 12 mm
 Art. 05.427.02 Ø 14 mm



Liscio / Smooth
 H.1000 mm
 Art. 05.427.04 Ø 12 mm
 Art. 05.427.05 Ø 14 mm



Liscio / Smooth
 H.1000 mm
 Art. 05.427.07 Ø 12 mm
 Art. 05.427.08 Ø 14 mm



Liscio / Smooth
 H.1000 mm
 Art. 05.427.10 Ø 12 mm
 Art. 05.427.11 Ø 14 mm



Liscio / Smooth
 H.950 mm
 Art. 05.427.50 12
 Art. 05.427.51 14
 H.1000 mm
 Art. 05.427.52 12
 Art. 05.427.53 14
 H.1200 mm
 Art. 05.427.54 12
 Art. 05.427.55 14
 H.1500 mm
 Art. 05.427.56 12
 Art. 05.427.57 14



Modello Catania / Catania model

PALLINE SU BARRE / BALLS ON BARS

SU RICHIESTA SIAMO IN GRADO DI PRODURRE I SEGUENTI PALETTI CON PALLINA ANCHE SU MISURA.
 ON REQUEST WE ARE ABLE TO MANUFACTURE THE FOLLOWING BALL ON BAR INFILLS, CUSTOMIZED ALSO AVAILABLE.



Paletti / Bars H. 1000

Pallina / Ball Ø 16 mm - H. 1000

Art. 05.427.100 tondo liscio Ø 12 mm con pallina Ø 16 mm / round plain 12 mm solid bar with 16 mm ball

Pallina / Ball Ø 18 mm - H. 1000

Art. 05.427.110 tondo liscio Ø 12 mm con pallina Ø 18 mm / round plain 12 mm solid bar with 18 mm ball

Art. 05.427.112 tondo liscio Ø 14 mm con pallina Ø 18 mm / round plain 14 mm solid bar with 18 mm ball

Art. 05.427.115 quadro liscio □ 12x12 mm con pallina Ø 18 mm / square plain □ 12x12 mm solid bar with 18 mm ball

Pallina / Ball Ø 20 mm - H. 1000

Art. 05.427.130 tondo liscio Ø 12 mm con pallina Ø 20 mm / round plain 12 mm solid bar with 20 mm ball

Art. 05.427.132 tondo liscio Ø 14 mm con pallina Ø 20 mm / round plain 14 mm solid bar with 20 mm ball

Art. 05.427.134 tondo liscio Ø 16 mm con pallina Ø 20 mm / round plain 16 mm solid bar with 20 mm ball

Art. 05.427.140 quadro liscio □ 12x12 mm con pallina Ø 20 mm / square plain □ 12x12 mm solid bar with 20 mm ball

Art. 05.427.142 quadro liscio □ 14x14 mm con pallina Ø 20 mm / square plain □ 14x14 mm solid bar with 20 mm ball

Pallina / Ball Ø 24 mm - H. 1000

Art. 05.427.160 tondo liscio Ø 12 mm con pallina Ø 24 mm / round plain 12 mm solid bar with 24 mm ball

Art. 05.427.162 tondo liscio Ø 14 mm con pallina Ø 24 mm / round plain 14 mm solid bar with 24 mm ball

Art. 05.427.164 tondo liscio Ø 16 mm con pallina Ø 24 mm / round plain 16 mm solid bar with 24 mm ball

Art. 05.427.170 quadro liscio □ 12x12 mm con pallina Ø 24 mm / square plain □ 12x12 mm solid bar with 24 mm ball

Art. 05.427.172 quadro liscio □ 14x14 mm con pallina Ø 24 mm / square plain □ 14x14 mm solid bar with 24 mm ball

Art. 05.427.174 quadro liscio □ 16x16 mm con pallina Ø 24 mm / square plain □ 16x16 mm solid bar with 24 mm ball



Tubi ferro conificati / Cone - shaped iron tubes

H.730 mm.
Art. 05.428 Ø 22
Art. 05.429 Ø 30
 H.830 mm.
Art. 05.430 Ø 22
Art. 05.431 Ø 30

Pigne a 9 Trafilati / 9 - Element Basket

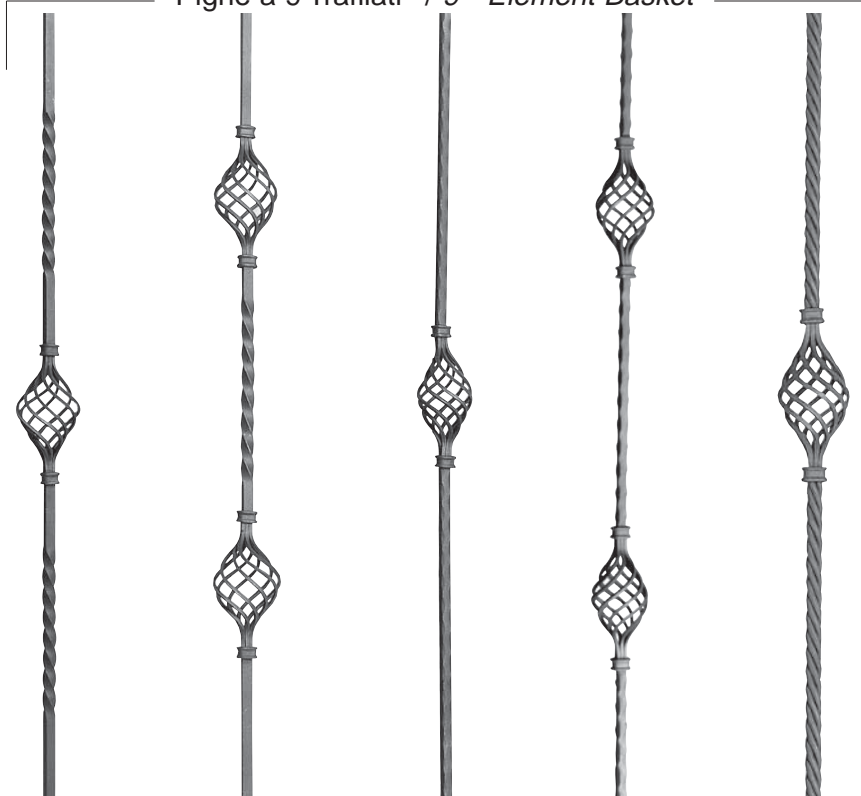

H.950 mm.
Art. 05.432 □ 12

H.950 mm.
Art. 05.433 □ 12

Martell. / Hammered
 H.950 mm.
Art. 05.434 □ 12

Martell. / Hammered
 H.950 mm.
Art. 05.435 □ 12

H.950 mm.
Art. 05.436 Ø 15

PANNELLI LISCI E PALETTI PER RECINZIONI
PLAIN PANEL UNITS AND STAKES FOR FENCES



H.900 X L.330 mm.
Art. 05.437 □ 14



H.900 X L.350 mm.
Art. 05.437.01 ≡ 12 X 6 mm.
Art. 05.437.02 ≡ 14 X 6 mm.



Martellato / *Hammered*
H.860 X L.350 mm.
Art. 05.438 ≡ 12 X 6 mm.
Art. 05.438.01 ≡ 16 X 5 mm.

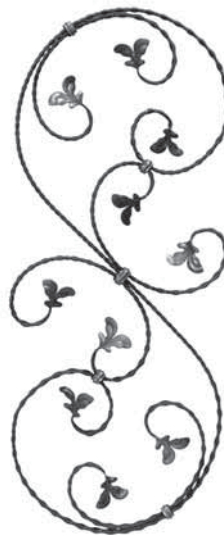

Martellato / *Hammered*
H.860 X L.350 mm.
Art. 05.438.02 ≡ 12 X 6 mm.
Art. 05.438.03 ≡ 16 X 5 mm.

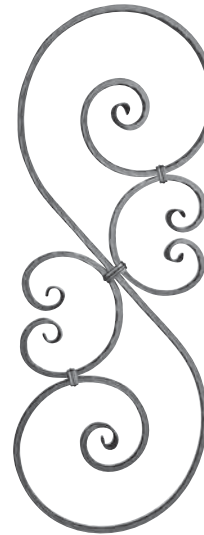

Liscio / *Smooth*
H.900 X L.330 mm.
Art. 05.439 □ 14



Con fiori su ambo i lati
Flowers on both sides
H.900 X L.350 mm.
Art. 05.440.01 □ 12

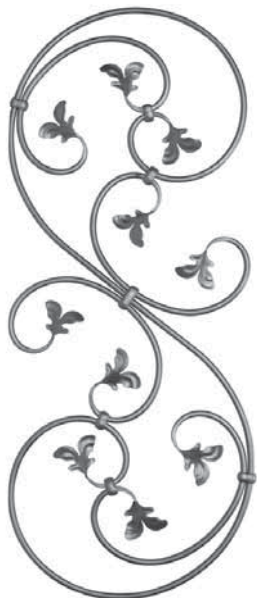

H.900 X L.350 mm.
Art. 05.440.02 Ø 10



Modello Scala / *Scala Model*
H.860 x L.350 mm
Art. 05.440.03 ≡ 14 x 6 mm



Liscio / *Smooth*
H.900 x L.370 mm
Art. 05.440.05 ≡ 12 x 6 mm



H.1100 mm.
Art. 05.441 □ 25
Art. 05.442 □ 30



Liscio / *Smooth*
H.950 mm.
Art. 05.443 Ø 12



Liscio / *Smooth*
H.950 mm.
Art. 05.444 Ø 12



Liscio / *Smooth*
H.950 mm.
Art. 05.445 Ø 12

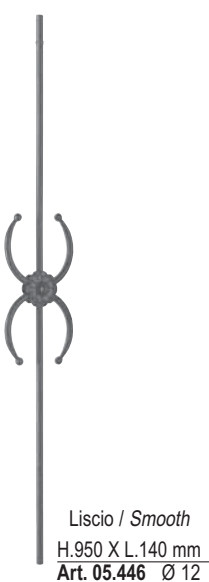

Liscio / *Smooth*
H.950 X L.140 mm
Art. 05.446 Ø 12



Liscio / *Smooth*
H.950 X L.100 mm.
Art. 05.447 Ø 12



Liscio / *Smooth*
H.950 X L.100 mm.
Art. 05.448 Ø 12



Liscio / *Smooth*
H.950 x L.180 mm
Art. 05.448.01 Ø 12 mm
Con fiori su ambo i lati /
Flowers on both sides



Fiore in ottone / *Brass flower*

Liscio / *Smooth*
H.950 x mm
Art. 05.448.02
Ø 12 mm
Art. 05.448.03
Ø 14 mm

Con fiori su ambo
i lati / *Flowers
on both sides*

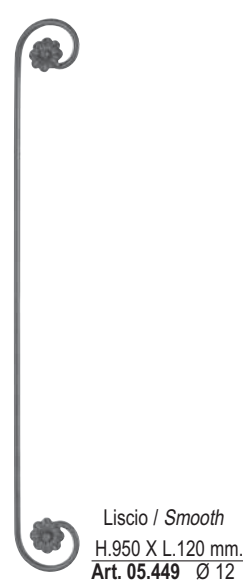

Liscio / *Smooth*
H.950 X L.120 mm.
Art. 05.449 Ø 12

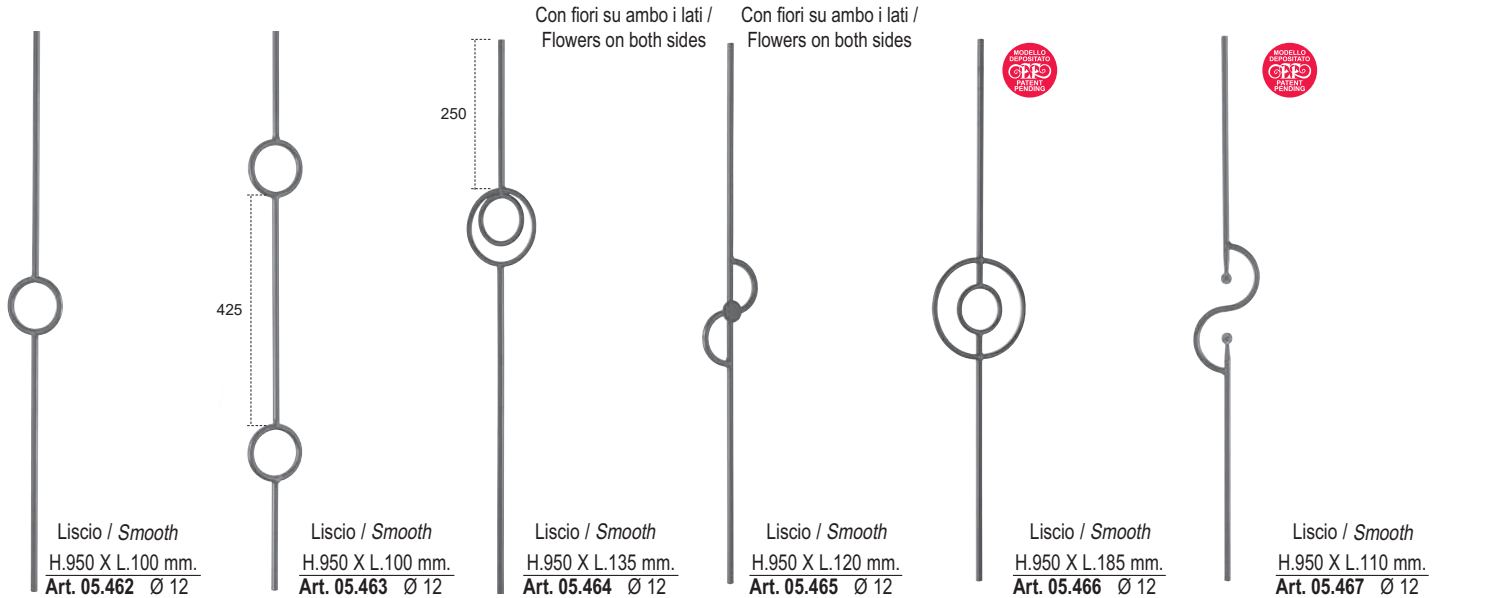
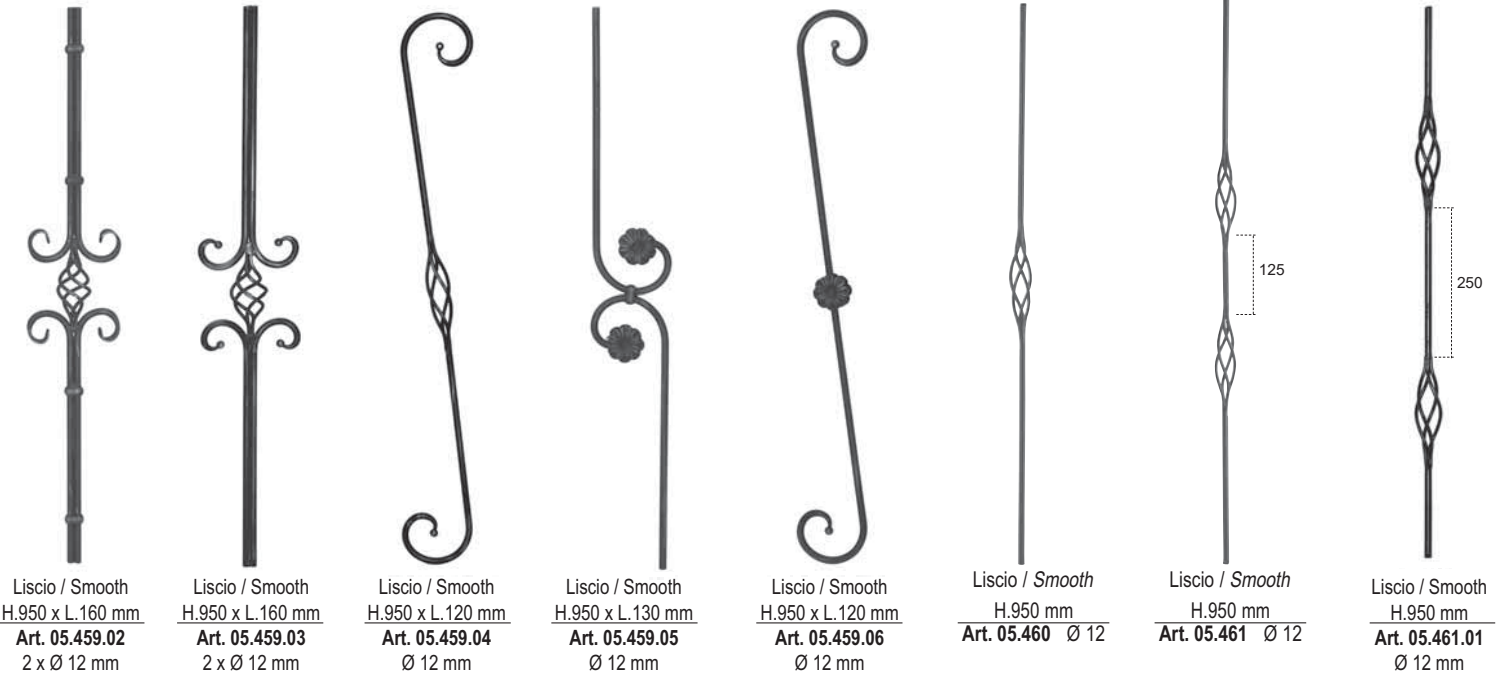
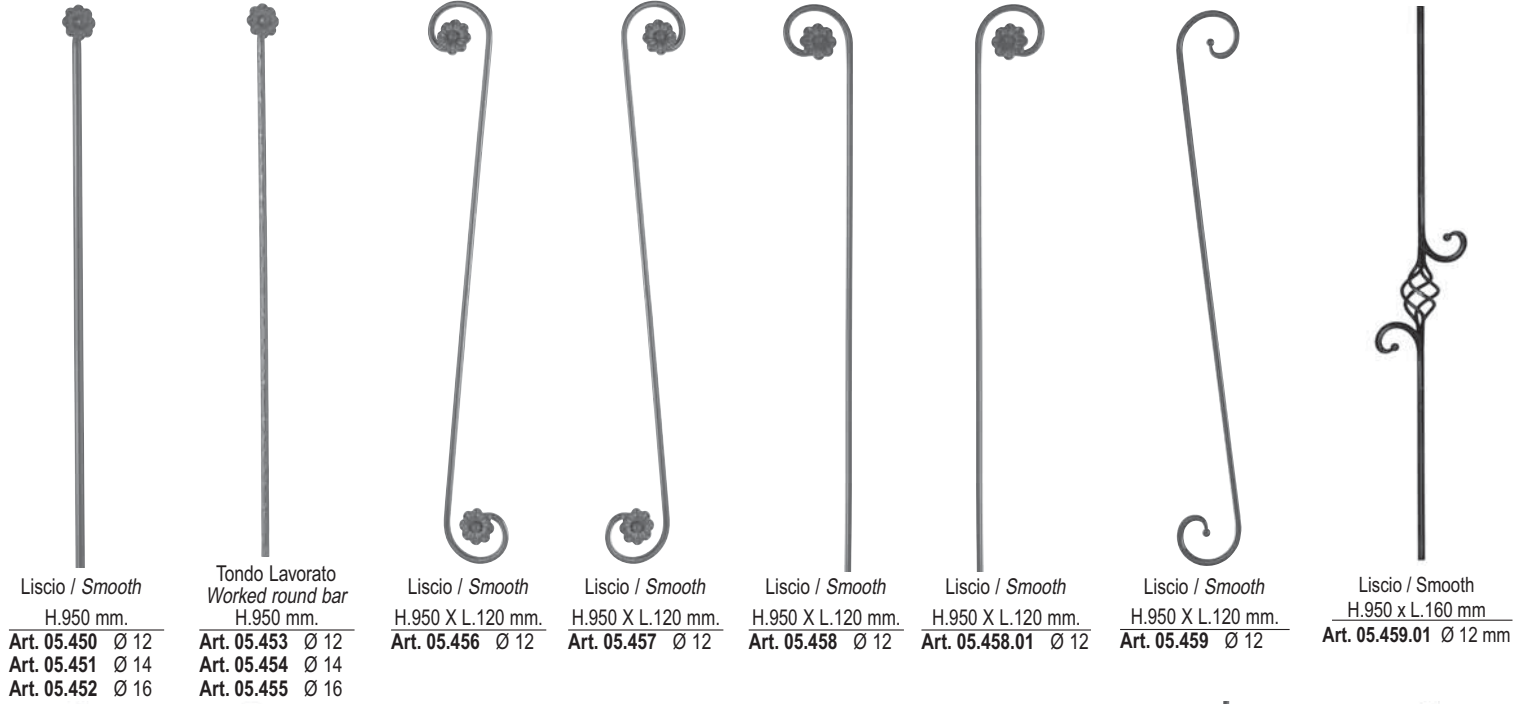

Tutte le parti di questo catalogo - foto comprese - sono di proprietà Euro-Fer. La riproduzione, anche parziale, è vietata in ogni forma e con ogni mezzo. / Every part of this catalogue - photos included - is Euro-Fer's property. All forms of copying are strictly prohibited.



Liscio / Smooth
 H.950 X L.100 mm.
 Art. 05.468 Ø 12



Liscio / Smooth
 H.950 X L.125 mm.
 Art. 05.469 Ø 12
 Art. 05.469.01 Ø 14



Liscio / Smooth
 H.950 X L.125 mm.
 Art. 05.470 Ø 12
 Art. 05.470.01 Ø 14



Liscio / Smooth
 H.950 X L.130 mm.
 Art. 05.471 Ø 12
 Art. 05.471.01 Ø 14



Liscio / Smooth
 H.950 X L.125 mm.
 Art. 05.472 Ø 12
 Art. 05.472.01 Ø 14



Liscio / Smooth
 H.950 X L.125 mm.
 Art. 05.473 Ø 12
 Art. 05.473.01 Ø 10



Liscio / Smooth
 H.950 X L.100 mm.
 Art. 05.474 Ø 10



Liscio / Smooth
 H.950 X L.100 mm.
 Art. 05.475 Ø 10

Cerchio
 Hole
 Ø 90 mm
 Cerchio
 Hole
 Ø 100 mm
 Cerchio
 Hole
 Ø 90 mm



Liscio / Smooth
 H.950 X L.140 mm.
 Art. 05.476 Ø 10



Liscio / Smooth
 H.950 X L.180 mm.
 Art. 05.477 Ø 12



Liscio / Smooth
 H.950 X L.75 mm.
 Art. 05.478 Ø 10
 Art. 05.478.01 Ø 12



Liscio / Smooth
 H.950 X L.85 mm.
 Art. 05.479 Ø 10
 Art. 05.479.01 Ø 12



Liscio / Smooth
 H.950 x L.150 mm
 Art. 05.479.02
 Ø 12 mm



Liscio / Smooth
 H.1000 x L.45 mm
 Art. 05.479.10
 Ø 12 mm



Liscio / Smooth
 H.1000 x L.45 mm
 Art. 05.479.11
 Ø 12 mm



Liscio / Smooth
 H.1000 x L.45 mm
 Art. 05.479.12
 Ø 12 mm



Liscio / Smooth
 H.1000 x L.45 mm
 Art. 05.479.13
 Ø 12 mm



Liscio / Smooth
 H.1000 x L.130 mm
 Art. 05.479.14
 Ø 12 mm



Liscio / Smooth
 H.1000 x L.45 mm
 Art. 05.479.15
 Ø 12 mm



Liscio / Smooth
 H.1000 x L.55 mm
 Art. 05.479.16
 Ø 12 mm



Liscio / Smooth
 H.1000 x L.85 mm
 Art. 05.479.18
 Ø 12 mm



Liscio / Smooth
 H.1000 x L.85 mm
 Art. 05.479.19
 Ø 12 mm



Liscio / Smooth
 H.1000 x L.65 mm
 Art. 05.479.20
 Ø 12 mm



Liscio / Smooth
 H.1000 x L.120 mm
Art. 05.479.29
 □ 12 mm
Art. 05.479.30
 □ 16 mm



Liscio / Smooth
 H.1000 x L.120 mm
Art. 05.479.31
 □ 16 mm



Liscio / Smooth
 H.1000 x L.120 mm
Art. 05.479.32
 □ 16 mm



Liscio / Smooth
 H.1000 x L.120 mm
Art. 05.479.33
 □ 16 mm



Liscio / Smooth
 H.1000 x L.120 mm
Art. 05.479.34
 □ 16 mm



Liscio / Smooth
 H.1000 x L.120 mm
Art. 05.479.35
 □ 16 mm



Liscio / Smooth
 H.950 X L.175 mm.
Art. 05.480 Ø 14



Liscio / Smooth
 H.950 X L.100 mm.
Art. 05.481 Ø 12



Liscio / Smooth
 H.950 X L.100 mm.
Art. 05.482 Ø 12



Liscio / Smooth
 H.950 X L.165 mm.
Art. 05.483 Ø 12



Liscio / Smooth
 H.950 X L.165 mm.
Art. 05.484 Ø 12



Liscio / Smooth
 H.950 X L.125 mm.
Art. 05.485 Ø 12



Liscio / Smooth
 H.950 X L.130 mm.
Art. 05.486 Ø 12



Liscio / Smooth
 H.950 X L.105 mm.
Art. 05.487 Ø 12



Liscio / Smooth
 H.950 X L.100 mm.
Art. 05.488 Ø 12



Con Ricalcatura
 New Forged
 Element



Liscio / Smooth
 H.950 X L.125 mm.
Art. 05.489 Ø 14



Liscio / Smooth
 H.950 X L.110 mm.
Art. 05.490 Ø 14



Liscio / Smooth
 H.950 X L.155 mm.
Art. 05.491 Ø 12

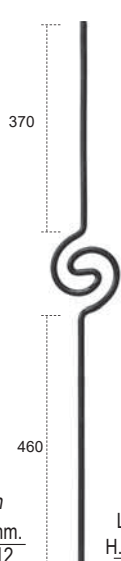

Liscio / Smooth
 H.990 x L.100 mm
Art. 05.491.10
 Ø 12 mm

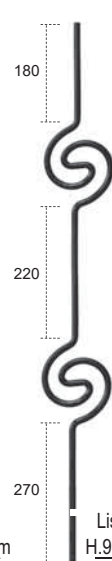

Liscio / Smooth
 H.990 x L.100 mm
Art. 05.491.11
 Ø 12 mm

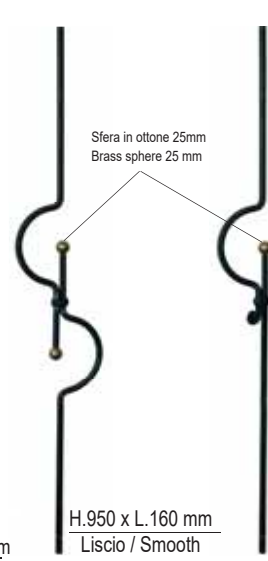

Liscio / Smooth
 H.950 x L.160 mm
Art. 05.491.20 Ø 12
Art. 05.491.21 Ø 14

Sfera in ottone 25mm
 Brass sphere 25 mm



Liscio / Smooth
 H.950 x L.110 mm
Art. 05.491.22 Ø 12
Art. 05.491.23 Ø 14

Tutte le parti di questo catalogo - foto comprese - sono di proprietà Euro-Fer. La riproduzione, anche parziale, è vietata in ogni forma e con ogni mezzo. / Every part of this catalogue - photos included - is Euro-Fer's property. All forms of copying are strictly prohibited.

PANNELLI LISCI E PALETTI PER RECINZIONI
PLAIN PANEL UNITS AND STAKES FOR FENCES



Liscio / Smooth
 H.950 X L.170 mm.
Art. 05.492 □ 12



Liscio / Smooth
 H.950 X L.100 mm.
Art. 05.493 □ 12



Liscio / Smooth
 H.950 x L.100 mm
Art. 05.493.02
 Ø 12 mm



Liscio / Smooth
 H.950 x L.100 mm
Art. 05.493.03
 Ø 12 mm



Liscio / Smooth
 H.950 X L.90 mm.
Art. 05.494 □ 12



Liscio / Smooth
 H.950.
Art. 05.495 □ 12

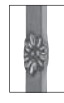

Liscio / Smooth
 H.950.
Art. 05.496 □ 12



Liscio / Smooth
 H.950.
Art. 05.497 □ 12



Liscio / Smooth
 H.950.
Art. 05.498 ≡ 16 x 8



Liscio / Smooth
 H.950.
Art. 05.499 ≡ 16 x 8



Liscio / Smooth
 H.950.
Art. 05.500 ≡ 16 x 8



Liscio / Smooth
 H.950
Art. 05.501.01 □ 12



Liscio / Smooth
 H.950
Art. 05.502.01 □ 12



Liscio / Smooth
 H.950
Art. 05.503 □ 12



Liscio / Smooth
 H.950 X L.100 mm.
Art. 05.504 □ 12



Liscio / Smooth
 H.950 X L.230 mm.
Art. 05.505 □ 12



Liscio / Smooth
 H.950 X L.230 mm.
Art. 05.506 □ 12



H.950 X L.100 mm.
Art. 05.507 □ 12
Art. 05.507.01 □ 16



H.950 X L.100 mm.
Art. 05.508 □ 12
Art. 05.508.01 □ 16



H.950 X L.115 mm.
Art. 05.509 □ 12



H.950 x L.100 mm
Art. 05.509.01
 □ 12 ≡ 12 x 6



H.950 x L.100 mm
Art. 05.509.02
 □ 12 ≡ 12 x 6



H.950 x L.115 mm
 Martellato / Hammered
Art. 05.509.05 □ 12
 Liscio / Smooth
Art. 05.509.06 □ 12

Tutte le parti di questo catalogo - foto comprese - sono di proprietà Euro-Fer. La riproduzione, anche parziale, è vietata in ogni forma e con ogni mezzo. / Every part of this catalogue - photos included - is Euro-Fer's property. All forms of copying are strictly prohibited.



H.950 X L.90 mm.
Art. 05.510 □ 12
Art. 05.510.01 □ 14



H.950 X L.145 mm.
Art. 05.511 □ 10



H.950 X L.140 mm.
Art. 05.512 □ 12



H.950 X L.140 mm.
Art. 05.513 □ 12



Liscio / Smooth
H.1000 x L.120 mm
Art. 05.513.100 □ 16
Art. 05.513.101 □ 20



Liscio / Smooth
H.1000 x L.120 mm
Art. 05.513.102 □ 16



Liscio / Smooth
H.1000 x L.120 mm
Art. 05.513.103 □ 16



Liscio / Smooth
H.1000 x L.135 mm
Art. 05.513.104 □ 16
Art. 05.513.105 □ 20



Liscio / Smooth
H.1000 x L.120 mm
Art. 05.513.106 □ 16



Liscio / Smooth
H.1000 x L.155 mm
Art. 05.513.107 □ 16



Liscio / Smooth
H.1000 x L.165 mm
Art. 05.513.108 □ 16



Liscio / Smooth
H.1000 x L.135 mm
Art. 05.513.109 □ 16



Liscio / Smooth
H.1000 x L.200 mm
Art. 05.513.110
□ 16 ≠ 16 x 8



Liscio / Smooth
H.1000 x L.190 mm
Art. 05.513.111
□ 16 ≠ 16 x 8



Liscio / Smooth
H.1000 x L.140 mm
Art. 05.513.112 □ 16



Liscio / Smooth
H.950 x L.225 mm
Art. 05.513.120
Ø 12 mm



Liscio / Smooth
H.950 x L.225 mm
Art. 05.513.121
Ø 12 mm



Liscio / Smooth
H.950 X L.145 mm.
Art. 05.514 □ 12



Liscio / Smooth
H.950 X L.200 mm.
Art. 05.515 □ 10



Liscio / Smooth
H.950 X L.165 mm.
Art. 05.516 □ 10



Liscio / Smooth
H.950 X L.200 mm.
Art. 05.517 □ 12



Liscio / Smooth
H. 950 X 115 mm
Art. 05.518 □ 12



Liscio / Smooth
H.950 X L.180 mm.
Art. 05.519 □ 12



Liscio / Smooth
H.950 X L.220 mm.
Art. 05.520 □ 12
≠ 12 x 6

PANNELLI LISCI E PALETTI PER RECINZIONI
PLAIN PANEL UNITS AND STAKES FOR FENCES



Liscio / Smooth
H.950 X L.175 mm.
Art. 05.521 □ 10
≡ 12 x 6

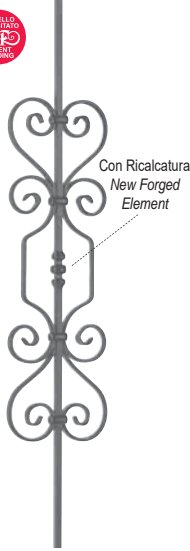

Liscio / Smooth
H.950 X L.180 mm.
Art. 05.522 □ 12
Con Ricalcatura
New Forged
Element



Liscio / Smooth
H.950 mm.
Art. 05.523 □ 12



Liscio / Smooth
H.950 mm.
Art. 05.523.01 □ 12



Martellato / Hammered
H.950 mm.
Art. 05.524 □ 12
Art. 05.524.01 □ 14



Martellato / Hammered
H.950 mm.
Art. 05.524.02 □ 12
Art. 05.524.03 □ 14



Liscio / Smooth
H.950 mm.
Art. 05.525 □ 12
Art. 05.525.01 □ 14



Liscio / Smooth
H.950 mm.
Art. 05.525.02 □ 12
Art. 05.525.03 □ 14



Liscio / Smooth
H.950 x L.60 mm
Art. 05.525.04 □ 12 mm



Liscio / Smooth
H.950 x L.60 mm
Art. 05.525.06 □ 12 mm



Liscio / Smooth
H.950 x L.75 mm
Art. 05.525.12 □ 12



Liscio / Smooth
H.950 mm.
Art. 05.526 □ 14
Art. 05.526.01 □ 12



Martellato / Hammered
H.950 mm.
Art. 05.527 □ 14
Art. 05.527.01 □ 12



Sfera / Sphere Ø22
H 950 mm
Art. 05.527.10 Ø12
H 1000 mm
Art. 05.527.11 Ø12



Sfera / Sphere Ø35

Art. 05.527.45 Ø12 H 950 mm
Art. 05.527.46 Ø12 H 1000 mm
Art. 05.527.47 Ø12 H 1200 mm

H 950 mm
Art. 05.527.50 Ø16
Art. 05.527.51 □ 12
Art. 05.527.52 □ 14

H 1000 mm
Art. 05.527.53 Ø16
Art. 05.527.54 □ 12
Art. 05.527.55 □ 14

H 1200 mm
Art. 05.527.56 Ø16
Art. 05.527.57 □ 12
Art. 05.527.58 □ 14

H 1500 mm
Art. 05.527.59 Ø16

Sfera / Sphere Ø30

Art. 05.527.60 Ø12 H 950 mm
Art. 05.527.61 Ø12 H 1000 mm
Art. 05.527.62 Ø12 H 1200 mm

Art. 05.527.64 Ø14 H 950 mm
Art. 05.527.65 Ø14 H 1000 mm
Art. 05.527.66 Ø14 H 1200 mm

Sfera / Sphere Ø25

H 950 mm
Art. 05.527.70 Ø12
Art. 05.527.71 Ø14

H 1000 mm
Art. 05.527.73 Ø12
Art. 05.527.74 Ø14

H 1200 mm
Art. 05.527.76 Ø12
Art. 05.527.77 Ø14

H 1500 mm
Art. 05.527.79 Ø12
Art. 05.527.80 Ø14

Art. 05.527.81 □ 12 H 950 mm
Art. 05.527.82 □ 12 H 1000 mm
Art. 05.527.83 □ 12 H 1200 mm

Sfera / Sphere Ø20

Art. 05.527.90 Ø12 H 950 mm
Art. 05.527.91 Ø12 H 1000 mm
Art. 05.527.92 Ø12 H 1200 mm



Sfera Forgiata Ø 25
/ Forged Sphere Ø 25

Art. 05.527.100 Ø12 H 1000 mm



Lancia elettrosaldata /
Electro-welded spear

Lancia mod. /
Spear mod.
Art.13.072

Liscio / Smooth

- H.950 mm.
- Art. 05.528 □ 12
- Art. 05.528.01 □ 14
- H.1000 mm.
- Art. 05.528.02 □ 12
- Art. 05.528.03 □ 14
- H.1200 mm.
- Art. 05.528.04 □ 12
- Art. 05.528.05 □ 14
- H.1500 mm.
- Art. 05.528.06 □ 12
- Art. 05.528.07 □ 14



Lancia elettrosaldata /
Electro-welded spear

Lancia mod. /
Spear mod.
Art.13.060.02

Liscio / Smooth

- H.950 mm.
- Art. 05.529 □ 12
- Art. 05.529.01 □ 14
- H.1000 mm.
- Art. 05.529.02 □ 12
- Art. 05.529.03 □ 14
- H.1200 mm.
- Art. 05.529.04 □ 12
- Art. 05.529.05 □ 14
- H.1500 mm.
- Art. 05.529.06 □ 12
- Art. 05.529.07 □ 14



Lancia elettrosaldata /
Electro-welded spear

Lancia mod. /
Spear mod.
Art.13.056

Liscio / Smooth

- H.950 mm.
- Art. 05.530 Ø 12
- Art. 05.530.01 Ø 14
- H.1000 mm.
- Art. 05.530.02 Ø 12
- Art. 05.530.03 Ø 14
- H.1200 mm.
- Art. 05.530.04 Ø 12
- Art. 05.530.05 Ø 14
- H.1500 mm.
- Art. 05.530.06 Ø 12
- Art. 05.530.07 Ø 14



Lancia elettrosaldata /
Electro-welded spear

Lancia mod. /
Spear mod.
Art.13.098.02

Liscio / Smooth

- H.950 mm.
- Art. 05.531 Ø 12
- Art. 05.531.01 Ø 14
- H.1000 mm.
- Art. 05.531.02 Ø 12
- Art. 05.531.03 Ø 14
- H.1200 mm.
- Art. 05.531.04 Ø 12
- Art. 05.531.05 Ø 14
- H.1500 mm.
- Art. 05.531.06 Ø 12
- Art. 05.531.07 Ø 14



Lancia elettrosaldata /
Electro-welded spear

Lancia mod. /
Spear mod.
Art.13.092

Liscio / Smooth

- H.950 mm
- Art. 05.531.08 □ 12 mm
- Art. 05.531.09 □ 14 mm
- H.1000 mm
- Art. 05.531.10 □ 12 mm
- Art. 05.531.11 □ 14 mm
- H.1200 mm
- Art. 05.531.12 □ 12 mm
- Art. 05.531.13 □ 14 mm
- H.1500 mm
- Art. 05.531.14 □ 12 mm
- Art. 05.531.15 □ 14 mm



Lancia elettrosaldata /
Electro-welded spear

Lancia mod. /
Spear mod.
Art.13.077

H.950 mm

- Art. 05.531.16 □ 12 mm
- Art. 05.531.17 □ 14 mm

H.1000 mm

- Art. 05.531.18 □ 12 mm
- Art. 05.531.19 □ 14 mm

H.1200 mm

- Art. 05.531.20 □ 12 mm
- Art. 05.531.21 □ 14 mm

H.1500 mm

- Art. 05.531.22 □ 12 mm
- Art. 05.531.23 □ 14 mm



Lancia elettrosaldata /
Electro-welded spear

Lancia mod. /
Spear mod.
Art.13.061

H.950 mm

- Art. 05.531.24 Ø 16 mm

H.1000 mm

- Art. 05.531.25 Ø 16 mm

H.1200 mm

- Art. 05.531.26 Ø 16 mm

H.1500 mm

- Art. 05.531.27 Ø 16 mm



Lancia elettrosaldata /
Electro-welded spear

Lancia mod. /
Spear mod.
Art.13.077.06

H.950 mm

- Art. 05.531.28 Ø 12 mm
- Art. 05.531.29 Ø 14 mm

H.1000 mm

- Art. 05.531.30 Ø 12 mm
- Art. 05.531.31 Ø 14 mm

H.1200 mm

- Art. 05.531.32 Ø 12 mm
- Art. 05.531.33 Ø 14 mm

H.1500 mm

- Art. 05.531.34 Ø 12 mm
- Art. 05.531.35 Ø 14 mm



Art. 05.531.80
□ 12 H 950 mm
Art. 05.531.81
□ 12 H 1000 mm
Art. 05.531.82
□ 12 H 1200 mm



Art. 05.531.100
Ø 12 H 1000 mm
Art. 05.531.101
Ø 12 H 1200 mm



Art. 05.531.110
□ 12 H 1000 mm
Art. 05.531.111
□ 12 H 1200 mm



Art. 05.531.116
Ø 12 H 1000 mm
Art. 05.531.117
Ø 12 H 1200 mm



Art. 05.531.120
Ø 12 H 1000 mm
Art. 05.531.121
Ø 12 H 1200 mm



Liscio / Smooth
H.950 X L.100 mm.
Art. 05.532 □ 12



Liscio / Smooth
H.950 X L.100 mm.
Art. 05.533 □ 12



Liscio / Smooth
H.950 X L.130 mm.
Art. 05.534 □ 12

425

Tutte le parti di questo catalogo - foto comprese - sono di proprietà Euro-Fer. La riproduzione, anche parziale, è vietata in ogni forma e con ogni mezzo. / Every part of this catalogue - photos included - is Euro-Fer's property. All forms of copying are strictly prohibited.

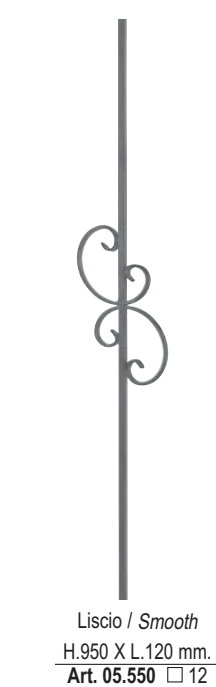
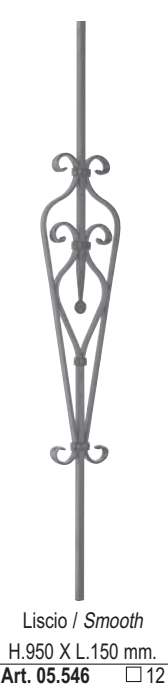
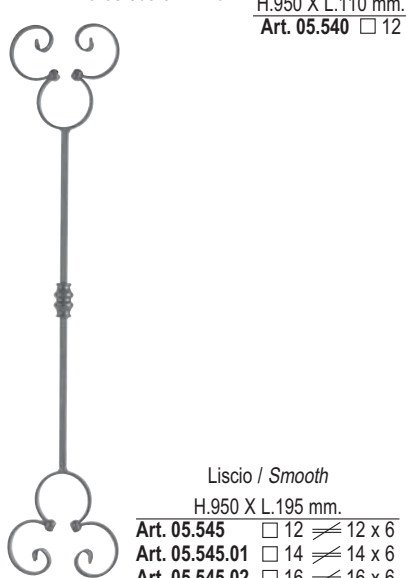
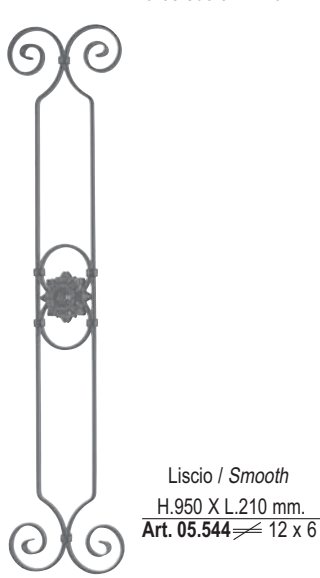
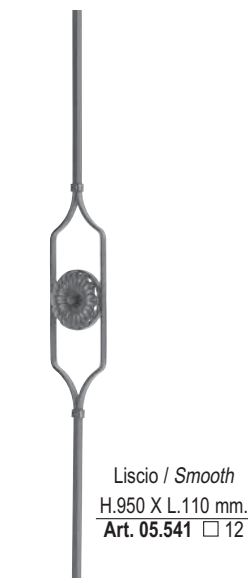
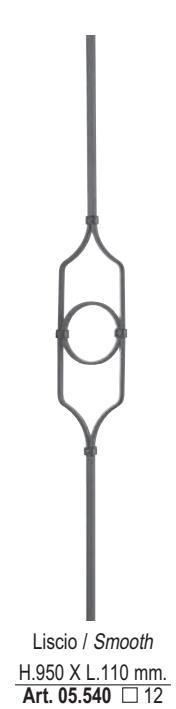
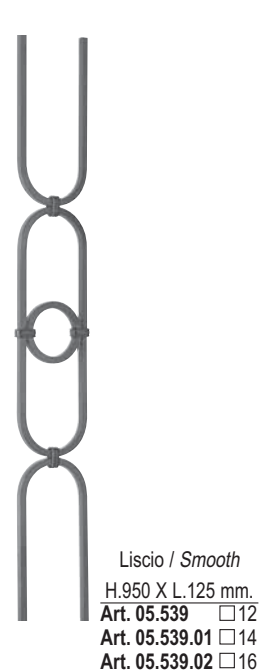
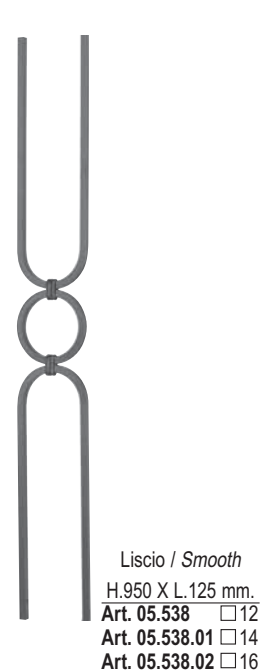
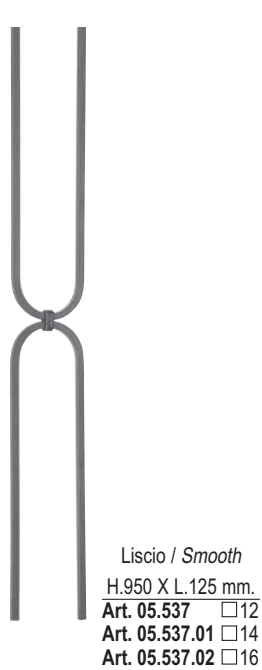
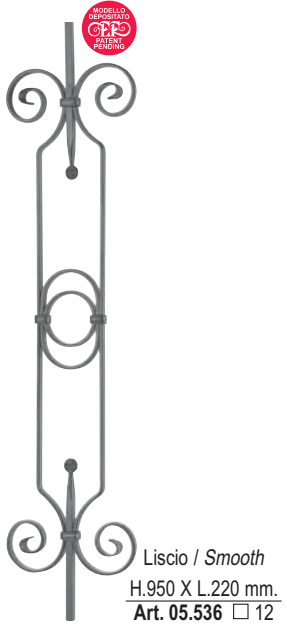
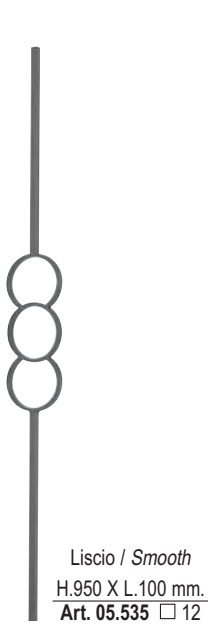

Tutte le parti di questo catalogo - foto comprese - sono di proprietà Euro-Fer. La riproduzione, anche parziale, è vietata in ogni forma e con ogni mezzo. / Every part of this catalogue - photos included - is Euro-Fer's property. All forms of copying are strictly prohibited.

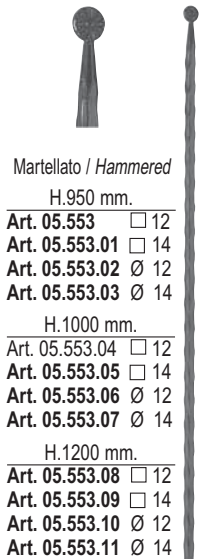

Martellato / Hammered
 H.950 mm.
 Art. 05.553 □ 12
 Art. 05.553.01 □ 14
 Art. 05.553.02 Ø 12
 Art. 05.553.03 Ø 14
 H.1000 mm.
 Art. 05.553.04 □ 12
 Art. 05.553.05 □ 14
 Art. 05.553.06 Ø 12
 Art. 05.553.07 Ø 14
 H.1200 mm.
 Art. 05.553.08 □ 12
 Art. 05.553.09 □ 14
 Art. 05.553.10 Ø 12
 Art. 05.553.11 Ø 14
 H.1500 mm.
 Art. 05.553.12 □ 12
 Art. 05.553.13 □ 14
 Art. 05.553.14 Ø 12
 Art. 05.553.15 Ø 14

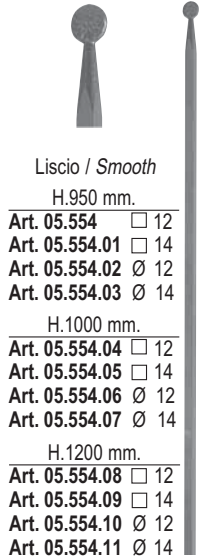

Liscio / Smooth
 H.950 mm.
 Art. 05.554 □ 12
 Art. 05.554.01 □ 14
 Art. 05.554.02 Ø 12
 Art. 05.554.03 Ø 14
 H.1000 mm.
 Art. 05.554.04 □ 12
 Art. 05.554.05 □ 14
 Art. 05.554.06 Ø 12
 Art. 05.554.07 Ø 14
 H.1200 mm.
 Art. 05.554.08 □ 12
 Art. 05.554.09 □ 14
 Art. 05.554.10 Ø 12
 Art. 05.554.11 Ø 14
 H.1500 mm.
 Art. 05.554.12 □ 12
 Art. 05.554.13 □ 14
 Art. 05.554.14 Ø 12
 Art. 05.554.15 Ø 14

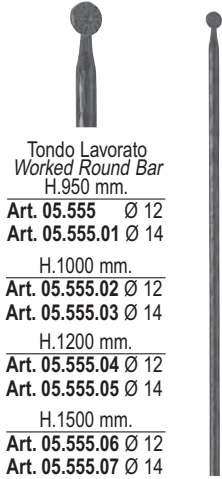

Tondo Lavorato / Worked Round Bar
 H.950 mm.
 Art. 05.555 Ø 12
 Art. 05.555.01 Ø 14
 H.1000 mm.
 Art. 05.555.02 Ø 12
 Art. 05.555.03 Ø 14
 H.1200 mm.
 Art. 05.555.04 Ø 12
 Art. 05.555.05 Ø 14
 H.1500 mm.
 Art. 05.555.06 Ø 12
 Art. 05.555.07 Ø 14

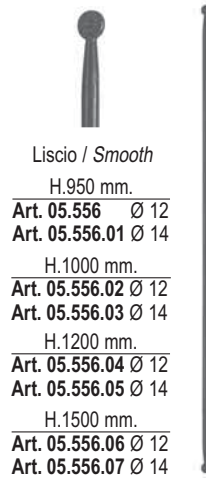

Liscio / Smooth
 H.950 mm.
 Art. 05.556 Ø 12
 Art. 05.556.01 Ø 14
 H.1000 mm.
 Art. 05.556.02 Ø 12
 Art. 05.556.03 Ø 14
 H.1200 mm.
 Art. 05.556.04 Ø 12
 Art. 05.556.05 Ø 14
 H.1500 mm.
 Art. 05.556.06 Ø 12
 Art. 05.556.07 Ø 14



Liscio / Smooth
 H.950 X L.250 mm.
 Art. 05.560 Ø 10
 Art. 05.560.01 Ø 12

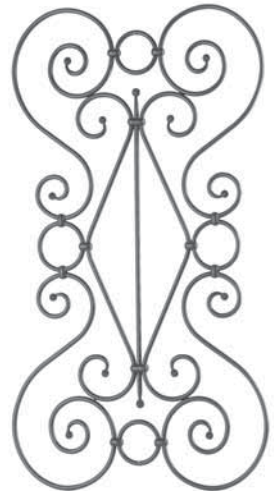

Liscio / Smooth
 H.950 X L.520 mm.
 Art. 05.561 Ø 10
 Art. 05.561.01 Ø 12



Liscio / Smooth
 H.950 x L.420 mm
 Art. 05.561.02 Ø 12
 Con fiori su ambo i lati /
 Flowers on both sides

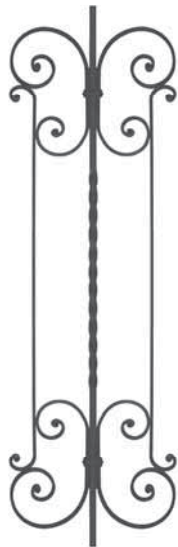

Liscio / Smooth
 H.1000 x L.310 mm
 Art. 05.561.05
 □ 12 mm ≠ 12 x 6 mm



Liscio / Smooth
 H.900 X L.175 mm.
 Art. 05.562 Ø 12



05.562.20
Liscio / Smooth
 H.1200 x L.420 mm ca.
 Rosa / Rose Ø 10 mm
 Paletto / Bar Ø 12 mm



05.562.21
Martellato / Hammered
 H.1200 x L.420 mm ca.
 Rosa / Rose Ø 12 mm
 Paletto / Bar Ø 12 mm

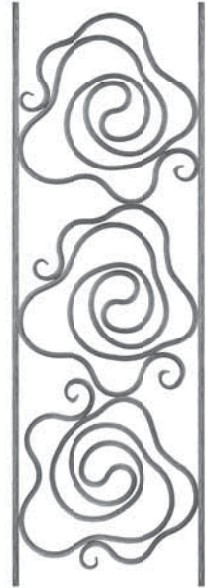

05.562.22
Modello Corteccia / Bark Model
 H.1200 x L.420 mm ca.
 Rosa / Rose Ø 12 mm
 Paletto / Bar Ø 12 mm



Tutte le parti di questo catalogo - foto comprese - sono di proprietà Euro-Fer. La riproduzione, anche parziale, è vietata in ogni forma e con ogni mezzo. / Every part of this catalogue - photos included - is Euro-Fer's property. All forms of copying are strictly prohibited.

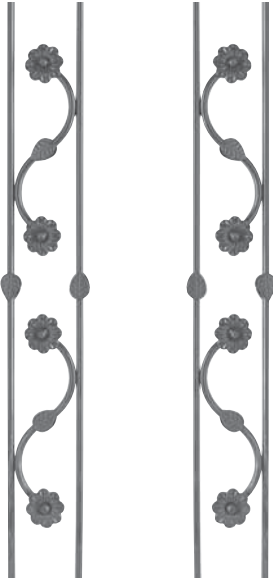

Liscio / Smooth
H.950 X L.120 mm.
Art. 05.563 Ø 12



Liscio / Smooth
H.950 X L.120 mm.
Art. 05.564 Ø 12

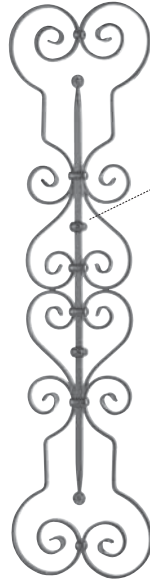

Con Ricalcatura
New Forged
Element

Liscio / Smooth
H.950 X L.245mm.
Art. 05.565 12 x 6
□ 12



Liscio / Smooth
H.950 x L.190 mm
Art. 05.566 Ø 12
Art. 05.567 □ 12



Liscio / Smooth
H.950 x L.240 mm
Art. 05.568 Ø 12
Art. 05.569 □ 12



Liscio / Smooth
H.950 x L.210 mm
Art. 05.570 Ø 12





Liscio / Smooth
H.950 x L.230 mm
Art. 05.590 Ø 12
Con fiori su ambo i lati /
Flowers on both sides



Rigato / Fluted
H.950 x L.100 mm
Art. 05.591 □ 14
Art. 05.591.01 □ 12
Con fiori su ambo i lati /
Flowers on both sides



Profilo a nuvola /
Cloud profile
H.950 mm
Art. 05.592 ≄ 20 x 12



Profilo a nuvola /
Cloud profile



Profilo nuvola /
Cloud profile
H.950 mm
Art. 05.592.01 ≄ 20 x 12



Forgiato / Forged
H.950 mm
Art. 05.593 □ 14



Forgiato / Forged
H.950 mm
Art. 05.593.01 □ 14



Pigna schiacciata /
Flatted Basket



Liscio / Smooth
H.950 x L.114 mm
Art. 05.600 □ 14

Con borchia in Acciaio Fuso / With Cast Steel stud Art.CI.13.921



Liscio / Smooth
H.950 mm
Art. 05.700 Ø 16 x 1,5
Tubo / Pipe bar



Liscio / Smooth
H.950 mm
Art. 05.701 Ø 16 x 1,5
Tubo / Pipe bar

370



Liscio / Smooth
H.950 mm
Art. 05.702 Ø 16 x 1,5
Tubo / Pipe bar



Liscio / Smooth
H.1750 x L.320 mm
Art. 05.729.08
□ 20 mm ≠ 16 x 8 mm



Liscio / Smooth
H.1750 x L.320 mm
Art. 05.729.09
□ 20 mm ≠ 16 x 8 mm

PANNELLI MARTELLATI HAMMERED PANELS



Mart./Hammered
H.950 mm.
Art. 06.001 □ 12
Art. 06.002 □ 14



Mart./Hammered
H.950 mm.
Art. 06.003
□ 12 X 12



Mart./Hammered
H.950 mm.
Art. 06.004
□ 12 X 12



Mart./Hammered
H.950 mm.
Art. 06.005
□ 12 X 12



Mart./Hammered
H.950 mm.
Art. 06.006
□ 12 X 12



Mart./Hammered
H.950 mm.
Art. 06.007
□ 12 X 12



Mart./Hammered
H.950 mm.
Art. 06.008 □ 12
Art. 06.008.01 □ 14
Art. 06.008.ES □ 12
Art. 06.008.01.ES □ 14



Mart./Hammered
H.950 mm.
Art. 06.009 □ 12
Art. 06.009.01 □ 14
Art. 06.009.ES □ 12
Art. 06.009.01.ES □ 14



Mart./Hammered
H.950 X L.130 mm.
Art. 06.010
□ 12 ≠ 12 X 6



Mart./Hammered
H.950 X L.200 mm.
Art. 06.011
□ 12 ≠ 12 X 6



Mart./Hammered
H.950 X L.150 mm.
Art. 06.012
□ 12 ≠ 12 X 6
Liscio / Smooth
Art. 06.012.01
□ 12 ≠ 12 X 6



Mart./Hammered
H.950 X L.150 mm.
Art. 06.013
□ 12 ≠ 12 X 6
Liscio / Smooth
Art. 06.013.01
□ 12 ≠ 12 X 6



Mart./Hammered
H.950 X L.140 mm.
Art. 06.014
□ 12 ≠ 12 X 6
Art. 06.014.01
□ 14 ≠ 14 X 6



Mart./Hammered
H.950 X L.135 mm.
Art. 06.015
□ 12 ≠ 12 X 6



Mart./Hammered
H.950 X L.170 mm.
Art. 06.016
□ 12 ≠ 12 X 6



Mart./Hammered
H.950 X L.170 mm.
Art. 06.017
□ 12 ≠ 12 X 6



Mart./Hammered
H.950 X L.135 mm.
Art. 06.018
□ 12 ≠ 12 X 6



Mart./Hammered
H.950 X L.120 mm.
Art. 06.019
□ 12 ≠ 12 X 6



Mart./Hammered
H.950 X L.170 mm.
Art. 06.020
□ 12 ≠ 12 X 6



Mart./Hammered
H.950 X L.165 mm.
Art. 06.021
□ 12 ≠ 12 X 6

Tutte le parti di questo catalogo - foto comprese - sono di proprietà Euro-Fer. La riproduzione, anche parziale, è vietata in ogni forma e con ogni mezzo. / Every part of this catalogue - photos included - is Euro-Fer's property. All forms of copying are strictly prohibited.



Mart./Hammered
H.950 X L.165 mm.
Art. 06.023
□ 12 ≠ 12 X 6



Mart./Hammered
H. 950 X L.165 mm.
Art. 06.024
□ 12 ≠ 12 x 6 mm



H.950 X L.185 mm.
Art. 06.025
□ 12 X 12
Mart./Hammered



H.950 X L.160 mm.
Art. 06.026
□ 12 ≠ 12 X 6
Mart./Hammered



H.950 X L.220 mm.
Art. 06.027
□ 12 ≠ 12 X 6
Mart./Hammered



H.950 mm.
Art. 06.028
□ 12 X 12
Mart./Hammered



Mart./Hammered
H.950 X L.150 mm.
Art. 06.029
□ 12 ≠ 12 X 6



Mart./Hammered
H.950 X L.215 mm.
Art. 06.029.01
□ 12 ≠ 12 X 6
Art. 06.029.08
□ 14 ≠ 14 X 6
Art. 06.029.09
□ 16 ≠ 16 X 6



Mart./Hammered
H.950 X L.275 mm.
Art. 06.029.02
□ 12 ≠ 12 X 6
Art. 06.029.10
□ 14 ≠ 14 X 6
Art. 06.029.11
□ 16 ≠ 16 X 6



Mart./Hammered
H.950 X L.275 mm.
Art. 06.029.03
□ 12 ≠ 12 X 6
Art. 06.029.12
□ 14 ≠ 14 X 6
Art. 06.029.13
□ 16 ≠ 16 X 6



Martellato/Hammered
H.950 X L.115 mm.
Art. 06.029.04
□ 12 ≠ 12 X 6



Martellato/Hammered
H.950 X L.200 mm.
Art. 06.029.05
□ 14 ≠ 14 X 6



Martellato/Hammered
H.950 X L.215 mm.
Art. 06.029.06
□ 14 ≠ 14 X 6



Martellato/Hammered
H.950 X L.205 mm.
Art. 06.029.07
□ 14 ≠ 14 X 6



Martellato / Hammered
H.950 x L.260 mm
Art. 06.029.14
□ 12 mm ≠ 12 x 6



Martellato Rigato / Hammered Fluted
H.950 x L.210 mm
Art. 06.029.15
□ 12 mm ≠ 12 x 6



Mart. / Hammered
H.1000 mm.
Art. 06.030 □ 12
Art. 06.031 □ 14
Art. 06.032 □ 16



Liscio / Smooth
H.1000 mm.
Art. 06.030.01 □ 12
Art. 06.030.02 □ 14
Art. 06.030.03 □ 16



Tondo / Round
H.1200 mm.
Art. 06.032.01 Ø 12
Art. 06.032.02 Ø 14
Art. 06.032.03 Ø 16



Liscio / Smooth
H.1200 mm.
Art. 06.032.04 □ 12
Art. 06.032.05 □ 14
Art. 06.032.06 □ 16



Batt. 4 lati/Beaten on 4 sides
H.1200 mm.
Art. 06.032.07 □ 12
Art. 06.032.08 □ 14
Art. 06.032.09 □ 16
H.1500 mm.
Art. 06.032.10 □ 16

Tutte le parti di questo catalogo - foto comprese - sono di proprietà Euro-Fer. La riproduzione, anche parziale, è vietata in ogni forma e con ogni mezzo. / Every part of this catalogue - photos included - is Euro-Fer's property. All forms of copying are strictly prohibited.

**PANNELLI MARTELLATI
HAMMERED PANELS**



Martellato / Hammered
H.1200 mm.
Art. 06.032.11 □12
Art. 06.032.12 □14
Art. 06.032.13 □16



Martellato / Hammered
H.250 mm.
Art. 06.033 □12
Art. 06.034 □14
Art. 06.035 □16



Tondo / Round
H.250 mm.
Art. 06.035.01 Ø 12
Art. 06.035.02 Ø 14
Art. 06.035.03 Ø 16



H.250 mm.
Art. 06.035.04 □12
Art. 06.035.05 □14
Art. 06.035.06 □16



Battuto 4 lati / Beaten on 4 sides
H.250 mm.
Art. 06.035.07 □12
Art. 06.035.08 □14
Art. 06.035.09 □16



Martellato / Hammered
H.250 mm.
Art. 06.035.10 □12
Art. 06.035.11 □14
Art. 06.035.12 □16



Mart./Hammered
H.950 X L.100 mm.
Art. 06.036
≠ 25 X 12



Mart./Hammered
H.950 X L.100 mm.
Art. 06.037
≠ 25 X 12



Mattone / Brick
H.950 X L.130 mm.
Art. 06.038
≠ 40 X 4



Mattone / Brick
H.950 X L.130 mm.
Art. 06.039
≠ 40 X 4



Martellato / Hammered
H.950 X L.230 mm.
Art. 06.040
□12 ≠ 12 X 6
Art. 06.040.01
□14 ≠ 14 X 6



Martellato / Hammered
H.950 X L.160 mm.
Art. 06.041
□12 ≠ 12 X 6
Art. 06.041.01
□14 ≠ 14 X 6



Martellato / Hammered
H.950 X L.160 mm.
Art. 06.042
□12 ≠ 12 X 6
Art. 06.042.01
□14 ≠ 14 X 6



Martellato / Hammered
H.950 X L.115 mm.
Art. 06.043
□12 ≠ 12 X 6
Art. 06.043.01
□14 ≠ 14 X 6

Tutte le parti di questo catalogo - foto comprese - sono di proprietà Euro-Fer. La riproduzione, anche parziale, è vietata in ogni forma e con ogni mezzo. / Every part of this catalogue - photos included - is Euro-Fer's property. All forms of copying are strictly prohibited.

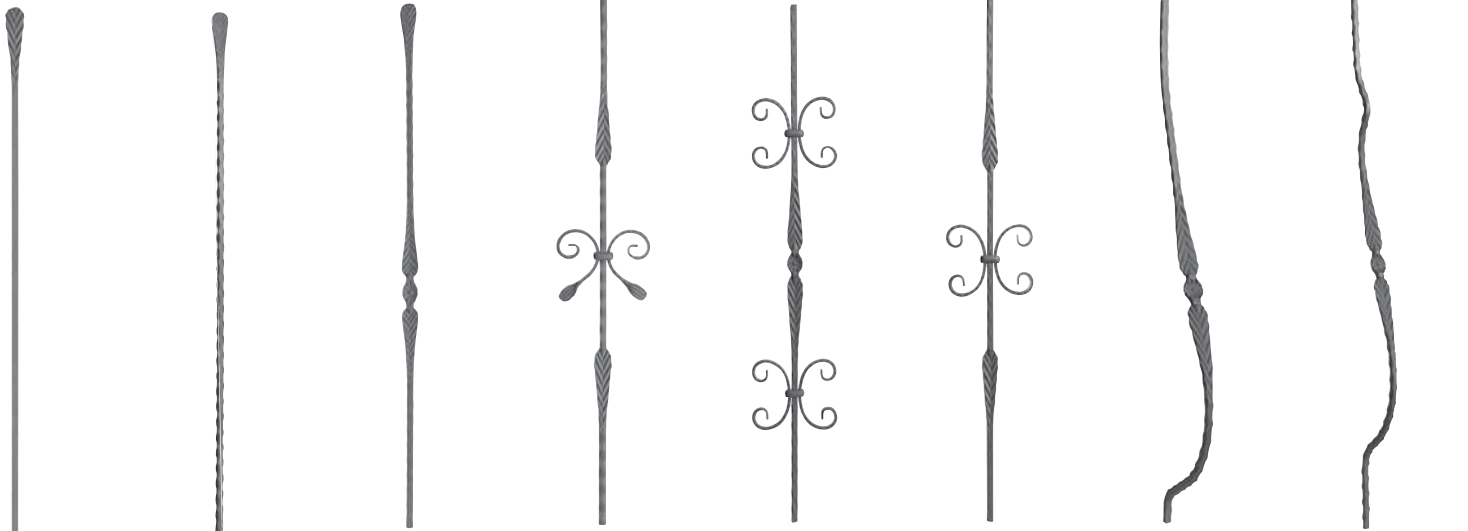

Liscio / Smooth
H.950 mm.
Art. 06.044 12
Art. 06.045 14

Martellato / Hammered
H.950 mm.
Art. 06.046 12
Art. 06.047 14

Martellato / Hammered
H.950 mm.
Art. 06.048 12
Art. 06.049 14

Martellato / Hammered
H.950 X L.170 mm.
Art. 06.050 12
Art. 06.050.01 14

Martellato / Hammered
H.950 X L.155 mm.
Art. 06.051 12
Art. 06.051.01 14

Martellato / Hammered
H.950 X L.155 mm.
Art. 06.052 12
Art. 06.052.01 14

Martellato / Hammered
H.950 X L.200 mm.
Art. 06.053 12
Art. 06.054 14

Martellato / Hammered
H.950 X L.125 mm.
Art. 06.055 12
Art. 06.056 14

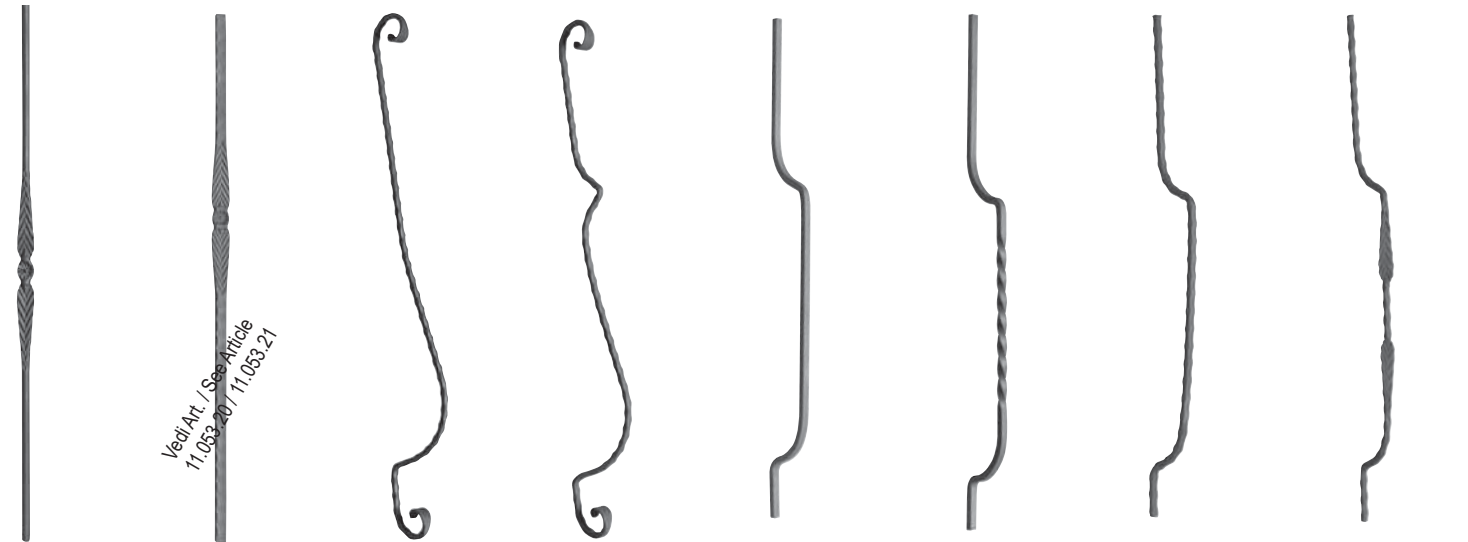

Tondo / Round
H.950 mm.
Art. 06.057 12
Art. 06.058 14

Martellato / Hammered
H.1100 mm.
Art. 06.059 20
Art. 06.060 25

Vedi Art. / See Article
11.053.20 / 11.053.21

Martellato / Hammered
H.1000 X L.150 mm.
Art. 06.061 12
Art. 06.062 14

Martellato / Hammered
H.1000 X L.150 mm.
Art. 06.063 12
Art. 06.064 14

H.950 X L.105 mm.
Art. 06.065 12
Art. 06.066 14

H.950 X L.105 mm.
Art. 06.067 12
Art. 06.068 14

Martellato / Hammered
H.950 X L.105 mm.
Art. 06.069 12
Art. 06.070 14

Martellato / Hammered
H.950 X L.105 mm.
Art. 06.071 12
Art. 06.072 14

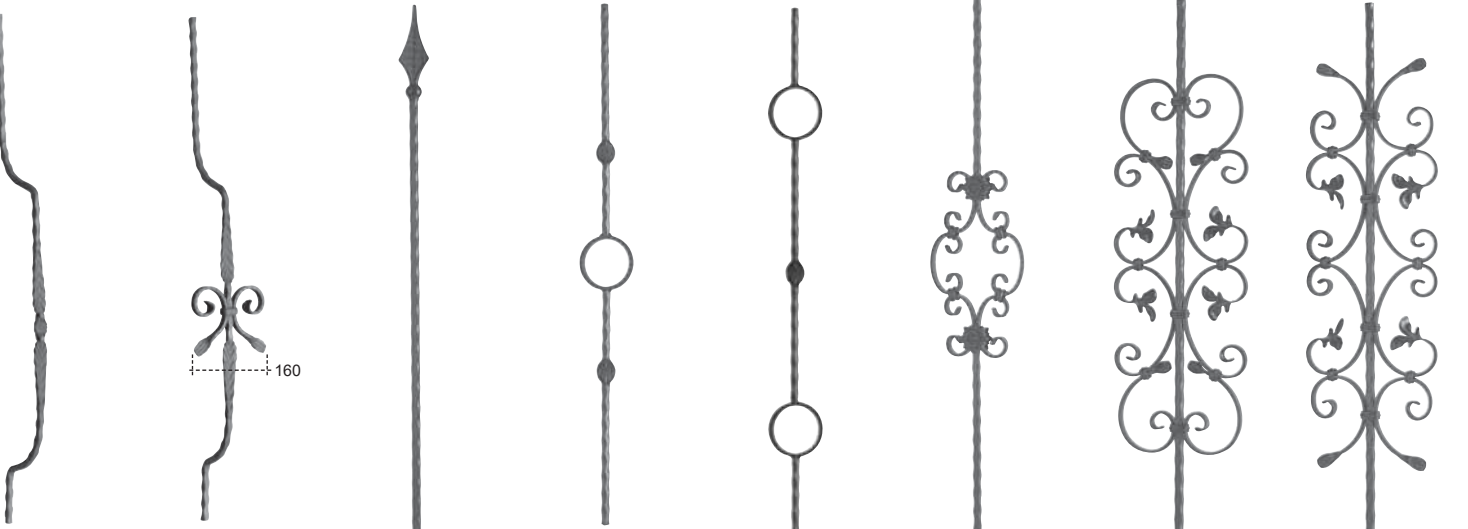

Martellato / Hammered
H.950 X L.105 mm.
Art. 06.073 12
Art. 06.074 14

Martellato / Hammered
H.950 X L.160 mm.
Art. 06.075 12
Art. 06.076 14

160

Martellato / Hammered
H.950 mm.
Art. 06.077 14

Martellato / Hammered
H.950 X L.100 mm.
Art. 06.078 12

Martellato / Hammered
H.950 X L.100 mm.
Art. 06.079 12













Martellato / Hammered
H.950 X L.180 mm.
Art. 06.080 12

Martellato / Hammered
H.950 X L.260 mm.
Art. 06.081 14

Martellato / Hammered
H.950 X L.260 mm.
Art. 06.082 14

Tutte le parti di questo catalogo - foto comprese - sono di proprietà Euro-Fer. La riproduzione, anche parziale, è vietata in ogni forma e con ogni mezzo. / Every part of this catalogue - photos included - is Euro-Fer's property. All forms of copying are strictly prohibited.



 H.950 mm. Art. 07.001 <input type="checkbox"/> 12 Art. 07.001.01 <input type="checkbox"/> 14 Art. 07.001.05 <input type="checkbox"/> 16	 Modello Liquirizia / Liquorice Model H.950 mm. Art. 07.001.02 <input type="checkbox"/> 12 Art. 07.001.03 <input type="checkbox"/> 14 Art. 07.001.06 <input type="checkbox"/> 16	 Modello Liquirizia / Liquorice Model H.950 mm Art. 07.001.07 <input type="checkbox"/> 12 Art. 07.001.08 <input type="checkbox"/> 14	 Modello Liquirizia / Liquorice Model H.950 mm Art. 07.001.09 <input type="checkbox"/> 12 Art. 07.001.10 <input type="checkbox"/> 14	 Modello Liquirizia / Liquorice Model H.950 mm Art. 07.001.11 <input type="checkbox"/> 12 Art. 07.001.12 <input type="checkbox"/> 14 Art. 07.001.13 <input type="checkbox"/> 16	 H.950 mm. Art. 07.002 <input type="checkbox"/> 12 Art. 07.002.01 <input type="checkbox"/> 14 Art. 07.002.03 <input type="checkbox"/> 16	 H.950 mm. Art. 07.003 <input type="checkbox"/> 12 Art. 07.003.01 <input type="checkbox"/> 14 Art. 07.003.06 <input type="checkbox"/> 16
 H.950 mm. Art. 07.002.02 <input type="checkbox"/> 16 x 8	 H.950 mm. Art. 07.003.02 <input type="checkbox"/> 16 x 8	 H.950 mm. Art. 07.003.05 <input type="checkbox"/> 16 x 8	 H.950 X L.140 mm. Art. 07.004 <input type="checkbox"/> 12 <input type="checkbox"/> 12 X 6	 H.950 X L.140 mm. Art. 07.005 <input type="checkbox"/> 12 <input type="checkbox"/> 12 X 6	 H.950 X L.100 Art. 07.006 <input type="checkbox"/> 12	



Particolare rigato
Fluted detail

Tutte le parti di questo catalogo - foto comprese - sono di proprietà Euro-Fer. La riproduzione, anche parziale, è vietata in ogni forma e con ogni mezzo. / Every part of this catalogue - photos included - is Euro-Fer's property. All forms of copying are strictly prohibited.



H.950 X L.105 mm.
Art. 07.007 □ 12



H.950 X L.115 mm.
Art. 07.007.01 □ 12



H.950 mm.
Art. 07.008 □ 12



H.950 mm.
Art. 07.009 □ 12



H.950 X L.165 mm.
Art. 07.010
□ 12 ≧ 12 X 6



H.950 X L.165 mm.
Art. 07.011
□ 12 ≧ 12 X 6



H.950 X L.145 mm.
Art. 07.012
□ 12 ≧ 12 X 6



H.950 X L.70 mm.
Art. 07.013 □ 12



H.950 X L.190 mm.
Art. 07.014
□ 12 ≧ 12 X 6



H.950 X L.145 mm.
Art. 07.015
□ 12 ≧ 12 X 6



H.950 X L.215 mm.
Art. 07.016
□ 12 ≧ 12 X 6



H.950 X L.170 mm.
Art. 07.017
□ 12 ≧ 12 X 6



H.950 X L.140 mm.
Art. 07.018
□ 12 ≧ 12 X 6



H.950 X L.230 mm.
Art. 07.019
□ 12 ≧ 12 X 6
Art. 07.019.01
□ 14 ≧ 14 X 6



Liscio / Smooth
H.950 x L.230 mm
Art. 07.019.02 □ 12
Art. 07.019.03 □ 14



H.950 X L.205 mm.
Art. 07.020
□ 12 ≧ 12 X 6
Art. 07.020.01
□ 14 ≧ 14 X 6

PANNELLI RIGATI CON PROFILO A NUVOLOLA / FLUTED PANELS "CLOUD"



H.950 X L.145 mm.
Art. 07.021
□ 12 ≧ 12 X 6



H.850 X L.200 mm.
Art. 07.022
□ 12 ≧ 12 X 6



H.850 X L.200 mm.
Art. 07.023
□ 12 ≧ 12 X 6

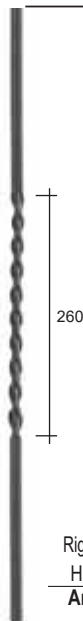

Rigato / Fluted
H.950 mm.
Art. 07.050
20 x 12



Rigato / Fluted
H.950 mm.
Art. 07.051
20 x 12



Rigato / Fluted
H.950 mm.
Art. 07.052
20 x 12



CON PROFILO
COME
ART. 12.263
WITH
SECTION AS
ART. 12.263

Tutte le parti di questo catalogo - foto comprese - sono di proprietà Euro-Fer. La riproduzione, anche parziale, è vietata in ogni forma e con ogni mezzo. / Every part of this catalogue - photos included - is Euro-Fer's property. All forms of copying are strictly prohibited.



H.900 mm
Art. 07.060 2 x Ø 8



H.900 mm
Art. 07.061 2 x Ø 8



H.900 x L.120 mm
Art. 07.064 2 x Ø 8



Tubo Liscio /
Smooth Tube
H.900 mm
Art. TB.21.900 Ø 30



Tubo Liscio /
Smooth Tube
H.900 mm
Art. TB.21.901 Ø 30



Tubo Liscio /
Smooth Tube
H.900 mm
Art. TB.21.902 Ø 30



Tubo Liscio /
Smooth Tube
H.900 mm
Art. TB.21.903 Ø 30



Tubo Liscio /
Smooth Tube
H.1200 mm
Art. TB.24.400 Ø 40



Tutte le parti di questo catalogo - foto comprese - sono di proprietà Euro-Fer. La riproduzione, anche parziale, è vietata in ogni forma e con ogni mezzo. / Every part of this catalogue - photos included - is Euro-Fer's property. All forms of copying are strictly prohibited.

Riassunto barre forate in ordine di codice pag. 234
Summary holed bars in order of code pag. 234



lunghezza standard 2000 mm / standard size 2000 mm.

interasse / centre distance

luce / distance between holes

- quadro / square
- ◇ foro quadro in obliquo / slanting square hole
- ∅ tondo / round
- ∅ foro ovale / oval hole
- ▭ foro rettangolo / rectangular hole
- ES foro largo / larger hole



sezione ferro	tipo ferro	codice	interasse	nr. fori	tipo fori	luce	trattamento
■ 12x12	liscio / smooth	08.006.01	120 mm	16 fori / holes	□ 12x12	108 mm	grezzo / raw
■ 14x14	liscio / smooth	08.119	125 mm	15 fori / holes	□ 14x14	111 mm	grezzo / raw
■ 14x14	liscio / smooth	ES 08.119.01	125 mm	14 fori / holes	□ 14x14	121 mm.	grezzo / raw
■ 14x14	liscio / smooth	08.001	140 mm	14 fori / holes	□ 14x14	126 mm	grezzo / raw
■ 16x16	liscio / smooth	08.120	125 mm	15 fori / holes	□ 16x16	109 mm	grezzo / raw
■ 16x16	liscio / smooth	08.131	125 mm	15 fori / holes	□ 14x14	111 mm	grezzo / raw
■ 16x16	liscio / smooth	ES 08.120.01	135 mm	14 fori / holes	□ 16x16	119 mm	grezzo / raw
■ 16x16	liscio / smooth	08.002	150 mm	13 fori / holes	□ 16x16	134 mm	grezzo / raw
■ 18x18	liscio / smooth	08.121	128 mm	14 fori / holes	□ 18x18	110 mm	grezzo / raw
■ 18x18	liscio / smooth	08.003	160 mm	12 fori / holes	□ 18x18	142 mm	grezzo / raw
■ 20x20	liscio / smooth	08.122	130 mm	13 fori / holes	□ 20x20	110 mm	grezzo / raw
■ 20x20	liscio / smooth	08.004	170 mm	11 fori / holes	□ 20x20	150 mm	grezzo / raw
■ 22x22	liscio / smooth	08.005	170 mm	11 fori / holes	□ 22x22	148 mm	grezzo / raw
■ 25x25	liscio / smooth	08.006	180 mm	10 fori / holes	□ 25x25	155 mm	grezzo / raw



sezione ferro	tipo ferro	codice	interasse	nr. fori	tipo fori	luce	trattamento
■ 14x14	liscio / smooth	08.123	128 mm	14 fori / holes	◇14x14 sullo spigolo / on the edge	108 mm	grezzo / raw
■ 14x14	liscio / smooth	08.007	140 mm	14 fori / holes	◇14x14 sullo spigolo / on the edge	120 mm	grezzo / raw
■ 16x16	liscio / smooth	08.124	130 mm	14 fori / holes	◇16x16 sullo spigolo / on the edge	107 mm	grezzo / raw
■ 16x16	liscio / smooth	08.008	150 mm	13 fori / holes	◇16x16 sullo spigolo / on the edge	127 mm	grezzo / raw
■ 18x18	liscio / smooth	08.125	132 mm	14 fori / holes	◇18x18 sullo spigolo / on the edge	107 mm	grezzo / raw
■ 18x18	liscio / smooth	08.009	160 mm	12 fori / holes	◇18x18 sullo spigolo / on the edge	135 mm	grezzo / raw
■ 20x20	liscio / smooth	08.126	134 mm	13 fori / holes	◇20x20 sullo spigolo / on the edge	106 mm	grezzo / raw
■ 20x20	liscio / smooth	08.010	170 mm	11 fori / holes	◇20x20 sullo spigolo / on the edge	142 mm	grezzo / raw
■ 22x22	liscio / smooth	08.011	170 mm	11 fori / holes	◇22x22 sullo spigolo / on the edge	139 mm	grezzo / raw
■ 25x25	liscio / smooth	08.012	180 mm	10 fori / holes	◇25x25 sullo spigolo / on the edge	145 mm	grezzo / raw



sezione ferro	tipo ferro	codice	interasse	nr. fori	tipo fori	luce	trattamento
■ 14x14	liscio / smooth	08.127	128 mm	14 fori / holes	◇14x14	108 mm	grezzo / raw
■ 14x14	liscio / smooth	ES 08.127.01	135 mm	14 fori / holes	◇14x14	115 mm	grezzo / raw
■ 14x14	liscio / smooth	08.013	140 mm	14 fori / holes	◇14x14	120 mm	grezzo / raw
■ 16x16	liscio / smooth	ES 08.128.02	125 mm	15 fori / holes	◇16x16	102 mm	grezzo / raw
■ 16x16	liscio / smooth	08.128	130 mm	14 fori / holes	◇16x16	107 mm	grezzo / raw
■ 16x16	liscio / smooth	ES 08.128.01	135 mm	14 fori / holes	◇16x16	112 mm	grezzo / raw
■ 16x16	liscio / smooth	08.014	150 mm	13 fori / holes	◇16x16	127 mm	grezzo / raw
■ 18x18	liscio / smooth	08.129	132 mm	14 fori / holes	◇18x18	107 mm	grezzo / raw
■ 18x18	liscio / smooth	ES 08.129.01	135 mm	14 fori / holes	◇18x18	110 mm	grezzo / raw
■ 18x18	liscio / smooth	08.015	160 mm	12 fori / holes	◇18x18	135 mm	grezzo / raw
■ 20x20	liscio / smooth	08.130	135 mm	13 fori / holes	◇20x20	107 mm	grezzo / raw
■ 20x20	liscio / smooth	08.016	170 mm	11 fori / holes	◇20x20	142 mm	grezzo / raw
■ 22x22	liscio / smooth	08.017	170 mm	11 fori / holes	◇22x22	139 mm	grezzo / raw
■ 25x25	liscio / smooth	08.018	180 mm	10 fori / holes	◇25x25	145 mm	grezzo / raw



sezione ferro	tipo ferro	codice	interasse	nr. fori	tipo fori	luce	trattamento
Ø 14	liscio / smooth	08.019	140 mm	14 fori / holes	Ø 14 ovale / oval		grezzo / raw
Ø 16	liscio / smooth	08.020	150 mm	13 fori / holes	Ø 16 ovale / oval		grezzo / raw
Ø 18	liscio / smooth	08.021	160 mm	12 fori / holes	Ø 18 ovale / oval		grezzo / raw
Ø 20	liscio / smooth	08.022	170 mm	11 fori / holes	Ø 20 ovale / oval		grezzo / raw

Riassunto barre forate in ordine di codice pag. 234
Summary holed bars in order of code pag. 234

lunghezza standard 2000 mm / standard size 2000 mm.

interasse / centre distance

luce / distance between holes

□ quadro / square

◇ foro quadro in obliquo / slanting square hole

∅ tondo / round

∅ foro ovale / oval hole

▭ foro rettangolo / rectangular hole

ES foro largo / larger hole



sezione ferro	tipo ferro	codice	interasse	nr. fori	tipo fori	luce	trattamento
∅ 12	liscio / smooth	08.029.01	120 mm	16 fori / holes	∅ 12	108 mm	grezzo / raw
∅ 14	liscio / smooth	08.115	125 mm	15 fori / holes	∅ 14	111 mm	grezzo / raw
∅ 14	liscio / smooth	08.115.01	130 mm	14 fori / holes	∅ 14	116 mm	grezzo / raw
∅ 14	liscio / smooth	08.023	140 mm	14 fori / holes	∅ 14	126 mm	grezzo / raw
∅ 16	liscio / smooth	08.116	125 mm	15 fori / holes	∅ 16	109 mm	grezzo / raw
∅ 16	liscio / smooth	08.132	125 mm	15 fori / holes	∅ 14	111 mm	grezzo / raw
∅ 16	liscio / smooth	08.024	150 mm	13 fori / holes	∅ 16	126 mm	grezzo / raw
∅ 16	liscio / smooth	08.116.01	160 mm	12 fori / holes	∅ 16	144 mm	grezzo / raw
∅ 18	liscio / smooth	08.117	128 mm	14 fori / holes	∅ 18	110 mm	grezzo / raw
∅ 18	liscio / smooth	08.025	160 mm	12 fori / holes	∅ 18	142 mm	grezzo / raw
∅ 20	liscio / smooth	08.118	130 mm	13 fori / holes	∅ 20	110 mm	grezzo / raw
∅ 20	liscio / smooth	08.026	170 mm	11 fori / holes	∅ 20	150 mm	grezzo / raw
∅ 22	liscio / smooth	08.027	170 mm	11 fori / holes	∅ 22	148 mm	grezzo / raw
∅ 25	liscio / smooth	08.028	180 mm	10 fori / holes	∅ 25	155 mm	grezzo / raw
∅ 30	liscio / smooth	08.029	200 mm	9 fori / holes	∅ 30	170 mm	grezzo / raw



sezione ferro	tipo ferro	codice	interasse	nr. fori	tipo fori	luce	trattamento
■ 14x14	liscio / smooth	08.106	140 mm	14 fori / holes	▭ 24x15 rettangolo / rectangular		grezzo / raw
■ 16x16	liscio / smooth	08.107	150 mm	13 fori / holes	▭ 30x17 rettangolo / rectangular		grezzo / raw
■ 18x18	liscio / smooth	08.108	160 mm	12 fori / holes	▭ 31x19 rettangolo / rectangular		grezzo / raw
■ 20x20	liscio / smooth	08.109	170 mm	11 fori / holes	▭ 33x21 rettangolo / rectangular		grezzo / raw



sezione ferro	tipo ferro	codice	interasse	nr. fori	tipo fori	luce	trattamento
∅ 14	corteccia / bark	08.130.01	125 mm	15 fori / holes	∅ 14	111 mm	grezzo / raw
∅ 14	corteccia / bark	08.109.01	140 mm	14 fori / holes	∅ 14	126 mm	grezzo / raw
∅ 16	corteccia / bark	08.130.02	125 mm	15 fori / holes	∅ 16	109 mm	grezzo / raw
∅ 16	corteccia / bark	08.109.02	150 mm	13 fori / holes	∅ 16	126 mm	grezzo / raw
∅ 18	corteccia / bark	08.130.03	128 mm	14 fori / holes	∅ 18	110 mm	grezzo / raw
∅ 18	corteccia / bark	08.109.03	160 mm	12 fori / holes	∅ 18	142 mm	grezzo / raw
∅ 20	corteccia / bark	08.109.04	170 mm	11 fori / holes	∅ 20	150 mm	grezzo / raw
∅ 22	corteccia / bark	08.109.05	170 mm	11 fori / holes	∅ 22	148 mm	grezzo / raw



sezione ferro	tipo ferro	codice	interasse	nr. fori	tipo fori	luce	trattamento
■ 12x12	martellato / hammered	08.110	120 mm	16 fori / holes	□ 12x12	108 mm	grezzo / raw
■ 14x14	martellato / hammered	08.111	140 mm	14 fori / holes	□ 14x14	126 mm	grezzo / raw
■ 16x16	martellato / hammered	08.112	150 mm	13 fori / holes	□ 16x16	134 mm	grezzo / raw
■ 18x18	martellato / hammered	08.113	160 mm	12 fori / holes	□ 18x18	142 mm	grezzo / raw
■ 20x20	martellato / hammered	08.114	170 mm	11 fori / holes	□ 20x20	150 mm	grezzo / raw



sezione ferro	tipo ferro	codice	interasse	nr. fori	tipo fori	luce	trattamento
■ 14x14	corteccia / bark	08.114.01	140 mm	14 fori / holes	□ 14x14	126 mm	grezzo / raw
■ 16x16	corteccia / bark	08.114.02	150 mm	13 fori / holes	□ 16x16	134 mm	grezzo / raw



sezione ferro	tipo ferro	codice	interasse	nr. fori	tipo fori	luce	trattamento
■ 14x14	corteccia / bark	08.114.10	140 mm	14 fori / holes	◇ 14x14	120 mm	grezzo / raw
■ 16x16	corteccia / bark	08.114.11	150 mm	13 fori / holes	◇ 16x16	127 mm	grezzo / raw



sezione ferro	tipo ferro	codice	interasse	nr. fori	tipo fori	luce	trattamento
■ 14x14	martellato / hammered	08.114.20	140 mm	14 fori / holes	◇ 14x14 sullo spigolo / on the edge	120 mm	grezzo / raw
■ 16x16	martellato / hammered	08.114.21	150 mm	13 fori / holes	◇ 16x16 sullo spigolo / on the edge	127 mm	grezzo / raw



sezione ferro	tipo ferro	codice	interasse	nr. fori	tipo fori	luce	trattamento
■ 12x12	in spigolo / edged	08.114.30	120 mm	16 fori / holes	□ 12x12	108 mm	grezzo / raw
■ 14x14	in spigolo / edged	08.114.31	140 mm	14 fori / holes	□ 14x14	126 mm	grezzo / raw
■ 16x16	in spigolo / edged	08.114.32	150 mm	13 fori / holes	□ 16x16	134 mm	grezzo / raw
■ 18x18	in spigolo / edged	08.114.33	160 mm	12 fori / holes	□ 18x18	142 mm	grezzo / raw

lunghezza standard 2000 mm / standard size 2000 mm.

interasse / centre distance

luce / distance between holes

□ quadro / square

◇ foro quadro in obliquo / slanting square hole

∅ tondo / round

∅ foro ovale / oval hole

▭ foro rettangolo / rectangular hole

ES foro largo / larger hole

SABBiate / SAND - BLASTED



sezione ferro	tipo ferro	codice	interasse	nr. fori	tipo fori	luce	trattamento
■ 12x12	liscio / smooth	08.133	120 mm	16 fori / holes	□ 12x12	108 mm	sabbiate / sandblasted
■ 14x14	liscio / smooth	08.168	125 mm	15 fori / holes	□ 14x14	111 mm	sabbiate / sandblasted
■ 14x14	liscio / smooth ES	08.168.01	125 mm	14 fori / holes	□ 14x14	121 mm.	sabbiate / sandblasted
■ 14x14	liscio / smooth	08.134	140 mm	14 fori / holes	□ 14x14	126 mm	sabbiate / sandblasted
■ 16x16	liscio / smooth	08.169	125 mm	15 fori / holes	□ 16x16	109 mm	sabbiate / sandblasted
■ 16x16	liscio / smooth	08.180	125 mm	15 fori / holes	□ 14x14	111 mm	sabbiate / sandblasted
■ 16x16	liscio / smooth ES	08.169.01	135 mm	14 fori / holes	□ 16x16	119 mm	sabbiate / sandblasted
■ 16x16	liscio / smooth	08.135	150 mm	13 fori / holes	□ 16x16	134 mm	sabbiate / sandblasted
■ 18x18	liscio / smooth	08.170	128 mm	14 fori / holes	□ 18x18	110 mm	sabbiate / sandblasted
■ 18x18	liscio / smooth	08.136	160 mm	12 fori / holes	□ 18x18	142 mm	sabbiate / sandblasted
■ 20x20	liscio / smooth	08.171	130 mm	13 fori / holes	□ 20x20	110 mm	sabbiate / sandblasted
■ 20x20	liscio / smooth	08.137	170 mm	11 fori / holes	□ 20x20	150 mm	sabbiate / sandblasted
■ 22x22	liscio / smooth	08.138	170 mm	11 fori / holes	□ 22x22	148 mm	sabbiate / sandblasted
■ 25x25	liscio / smooth	08.139	180 mm	10 fori / holes	□ 25x25	155 mm	sabbiate / sandblasted

SABBiate / SAND - BLASTED



sezione ferro	tipo ferro	codice	interasse	nr. fori	tipo fori	luce	trattamento
■ 14x14	liscio / smooth	08.172	128 mm	14 fori / holes	◇ 14x14 sullo spigolo / on the edge	108 mm	sabbiate / sandblasted
■ 14x14	liscio / smooth	08.140	140 mm	14 fori / holes	◇ 14x14 sullo spigolo / on the edge	120 mm	sabbiate / sandblasted
■ 16x16	liscio / smooth	08.173	130 mm	14 fori / holes	◇ 16x16 sullo spigolo / on the edge	107 mm	sabbiate / sandblasted
■ 16x16	liscio / smooth	08.141	150 mm	13 fori / holes	◇ 16x16 sullo spigolo / on the edge	127 mm	sabbiate / sandblasted
■ 18x18	liscio / smooth	08.174	132 mm	14 fori / holes	◇ 18x18 sullo spigolo / on the edge	107 mm	sabbiate / sandblasted
■ 18x18	liscio / smooth	08.142	160 mm	12 fori / holes	◇ 18x18 sullo spigolo / on the edge	135 mm	sabbiate / sandblasted
■ 20x20	liscio / smooth	08.175	134 mm	13 fori / holes	◇ 20x20 sullo spigolo / on the edge	106 mm	sabbiate / sandblasted
■ 20x20	liscio / smooth	08.143	170 mm	11 fori / holes	◇ 20x20 sullo spigolo / on the edge	142 mm	sabbiate / sandblasted
■ 22x22	liscio / smooth	08.144	170 mm	11 fori / holes	◇ 22x22 sullo spigolo / on the edge	139 mm	sabbiate / sandblasted
■ 25x25	liscio / smooth	08.145	180 mm	10 fori / holes	◇ 25x25 sullo spigolo / on the edge	145 mm	sabbiate / sandblasted

Riassunto barre forate in ordine di codice pag. 234
Summary holed bars in order of code pag. 234

SABBiate / SAND - BLASTED



sezione ferro	tipo ferro	codice	interasse	nr. fori	tipo fori	luce	trattamento
■ 14x14	liscio / smooth	08.176	128 mm	14 fori / holes	◇14x14	108 mm	sabbiato / sandblasted
■ 14x14	liscio / smooth ES	08.176.01	135 mm	14 fori / holes	◇14x14	115 mm	sabbiato / sandblasted
■ 14x14	liscio / smooth	08.146	140 mm	14 fori / holes	◇14x14	120 mm	sabbiato / sandblasted
■ 16x16	liscio / smooth ES	08.177.02	125 mm	15 fori / holes	◇16x16	102 mm	sabbiato / sandblasted
■ 16x16	liscio / smooth	08.177	130 mm	14 fori / holes	◇16x16	107 mm	sabbiato / sandblasted
■ 16x16	liscio / smooth ES	08.177.01	135 mm	14 fori / holes	◇16x16	112 mm	sabbiato / sandblasted
■ 16x16	liscio / smooth	08.147	150 mm	13 fori / holes	◇16x16	127 mm	sabbiato / sandblasted
■ 18x18	liscio / smooth	08.178	132 mm	14 fori / holes	◇18x18	107 mm	sabbiato / sandblasted
■ 18x18	liscio / smooth ES	08.178.01	135 mm	14 fori / holes	◇18x18	110 mm	sabbiato / sandblasted
■ 18x18	liscio / smooth	08.148	160 mm	12 fori / holes	◇18x18	135 mm	sabbiato / sandblasted
■ 20x20	liscio / smooth	08.179	135 mm	13 fori / holes	◇20x20	107 mm	sabbiato / sandblasted
■ 20x20	liscio / smooth	08.149	170 mm	11 fori / holes	◇20x20	142 mm	sabbiato / sandblasted
■ 22x22	liscio / smooth	08.150	170 mm	11 fori / holes	◇22x22	139 mm	sabbiato / sandblasted
■ 25x25	liscio / smooth	08.151	180 mm	10 fori / holes	◇25x25	145 mm	sabbiato / sandblasted

SABBiate / SAND - BLASTED



sezione ferro	tipo ferro	codice	interasse	nr. fori	tipo fori	luce	trattamento
Ø 14	liscio / smooth	08.152	140 mm	14 fori / holes	Ø 14 ovale / oval		sabbiato / sandblasted
Ø 16	liscio / smooth	08.153	150 mm	13 fori / holes	Ø 16 ovale / oval		sabbiato / sandblasted
Ø 18	liscio / smooth	08.154	160 mm	12 fori / holes	Ø 18 ovale / oval		sabbiato / sandblasted
Ø 20	liscio / smooth	08.155	170 mm	11 fori / holes	Ø 20 ovale / oval		sabbiato / sandblasted

SABBiate / SAND - BLASTED



sezione ferro	tipo ferro	codice	interasse	nr. fori	tipo fori	luce	trattamento
Ø 12	liscio / smooth	08.156	120 mm	16 fori / holes	Ø 12	108 mm	sabbiato / sandblasted
Ø 14	liscio / smooth	08.164	125 mm	15 fori / holes	Ø 14	111 mm	sabbiato / sandblasted
Ø 14	liscio / smooth	08.164.01	130 mm	14 fori / holes	Ø 14	116 mm	sabbiato / sandblasted
Ø 14	liscio / smooth	08.157	140 mm	14 fori / holes	Ø 14	126 mm	sabbiato / sandblasted
Ø 16	liscio / smooth	08.165	125 mm	15 fori / holes	Ø 16	109 mm	sabbiato / sandblasted
Ø 16	liscio / smooth	08.181	125 mm	15 fori / holes	Ø 14	111 mm	sabbiato / sandblasted
Ø 16	liscio / smooth	08.158	150 mm	13 fori / holes	Ø 16	126 mm	sabbiato / sandblasted
Ø 16	liscio / smooth	08.165.01	160 mm	12 fori / holes	Ø 16	144 mm	sabbiato / sandblasted
Ø 18	liscio / smooth	08.166	128 mm	14 fori / holes	Ø 18	110 mm	sabbiato / sandblasted
Ø 18	liscio / smooth	08.159	160 mm	12 fori / holes	Ø 18	142 mm	sabbiato / sandblasted
Ø 20	liscio / smooth	08.167	130 mm	13 fori / holes	Ø 20	110 mm	sabbiato / sandblasted
Ø 20	liscio / smooth	08.160	170 mm	11 fori / holes	Ø 20	150 mm	sabbiato / sandblasted
Ø 22	liscio / smooth	08.161	170 mm	11 fori / holes	Ø 22	148 mm	sabbiato / sandblasted
Ø 25	liscio / smooth	08.162	180 mm	10 fori / holes	Ø 25	155 mm	sabbiato / sandblasted
Ø 30	liscio / smooth	08.163	200 mm	9 fori / holes	Ø 30	170 mm	sabbiato / sandblasted

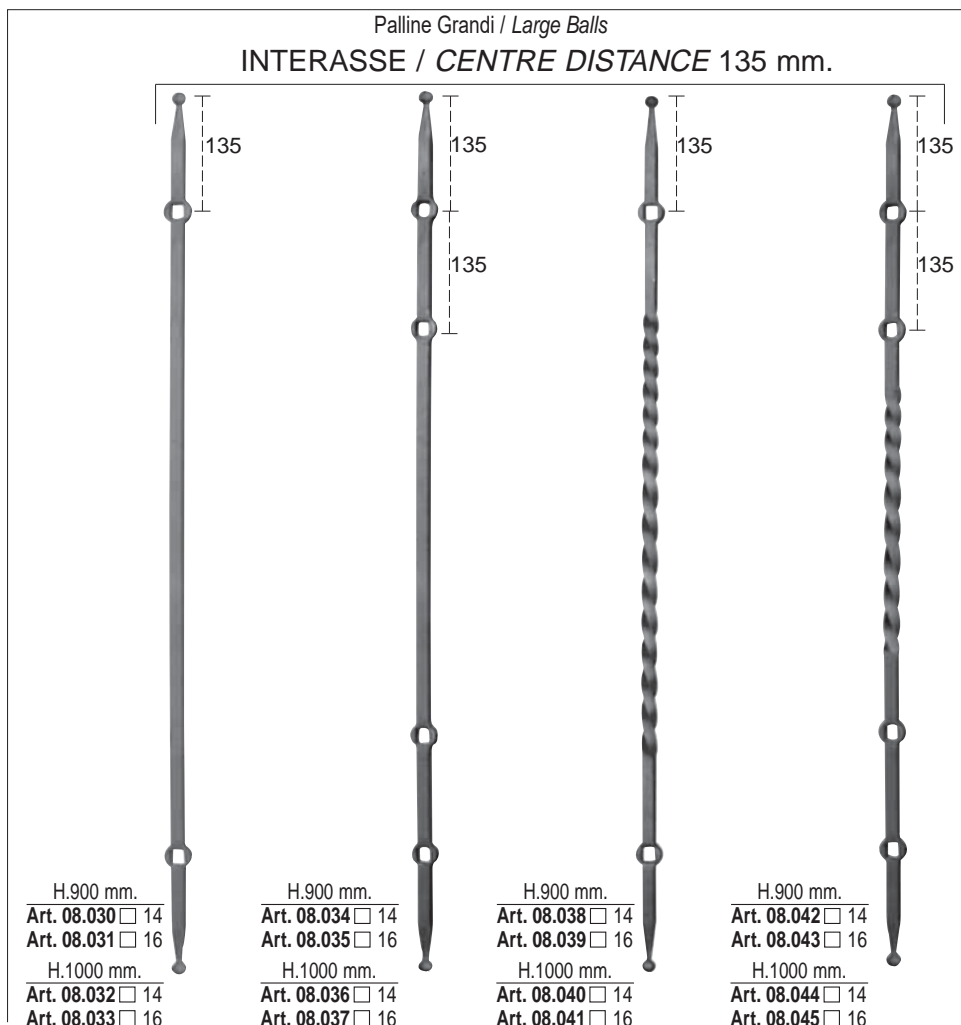

BARRE FORATE - Piantoni "Portofino" HOLED BARS - "Portofino" Posts

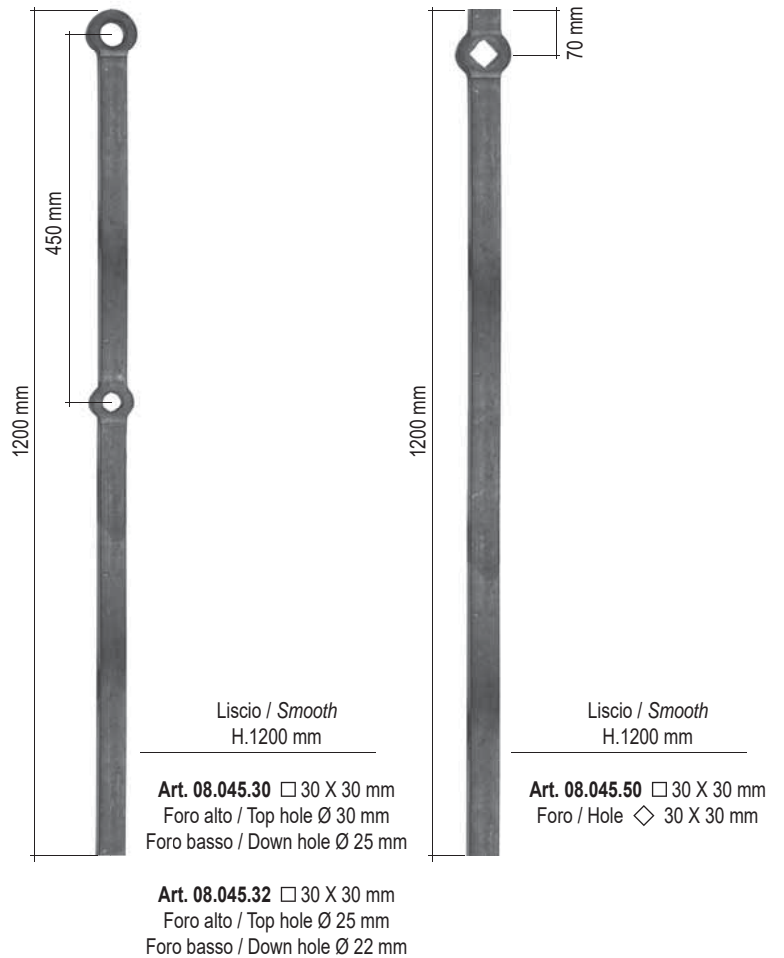
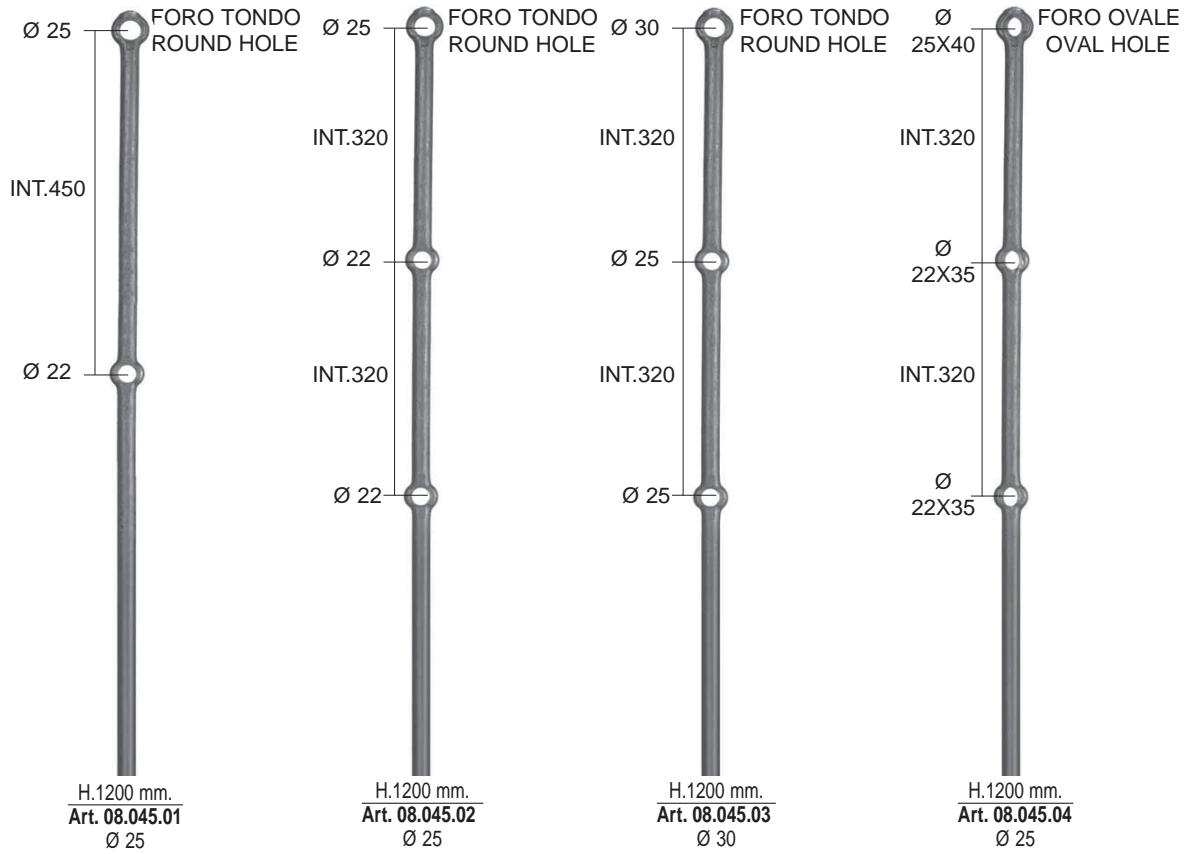

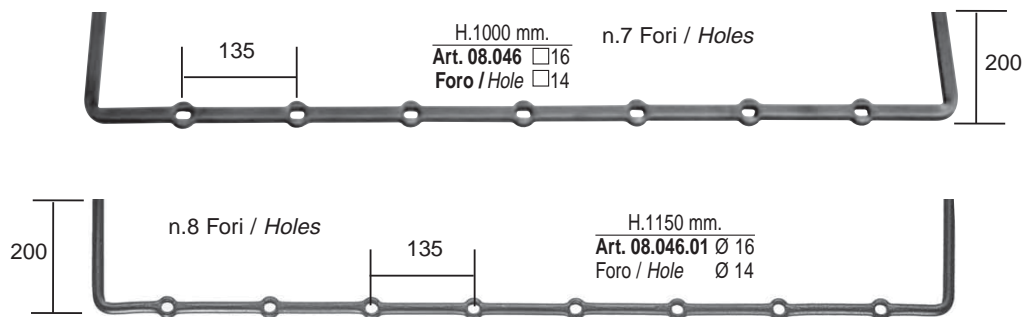

INT. standard: 125 mm. - n. Fori 15

MISURE STANDARD 2000 mm. / 2000 mm. STANDARD SIZE

INT. = INTERASSE / CENTRE DISTANCE

LUCE = DISTANCE BETWEEN HOLES

FORO = HOLE

FORO QUADRO IN OBLIQUO
SLANTING SQUARE HOLE

INT. 125
INT. 125
15 Fori per barra
Holes per bar

H.2000 mm. Foro \diamond 12
Art. 08.047 \neq 30 X 8
Art. 08.048 \neq 30 X 10
Art. 08.049 \neq 35 X 8
Art. 08.050 \neq 35 X 10
Art. 08.051 \neq 40 X 8
Art. 08.052 \neq 40 X 10
H.2000 mm. Foro \diamond 14
Art. 08.053 \neq 30 X 8
Art. 08.054 \neq 30 X 10
Art. 08.055 \neq 35 X 8
Art. 08.056 \neq 35 X 10
Art. 08.057 \neq 40 X 8
Art. 08.058 \neq 40 X 10
H.2000 mm. Foro \diamond 16
Art. 08.058.01 \neq 30 X 8
Art. 08.058.02 \neq 30 X 10
Art. 08.058.03 \neq 35 X 8
Art. 08.058.04 \neq 35 X 10
Art. 08.058.05 \neq 40 X 8
Art. 08.058.06 \neq 40 X 10

FORO QUADRO IN OBLIQUO
SLANTING SQUARE HOLE

INT. 149

INT. 149 mm.
Luce 128 mm.
n. Fori 12

H.2000 mm. Foro \diamond 14
Art. 08.058.07 \neq 30 X 8
Art. 08.058.08 \neq 30 X 10

FORO QUADRO IN OBLIQUO
SLANTING SQUARE HOLE

INT. 74,5

INT. 74,5 mm.
Luce 53,5 mm.
n. Fori 26

H.2000 mm. Foro \diamond 14
Art. 08.058.09 \neq 30 X 8
Art. 08.058.10 \neq 30 X 10

FORO QUADRO
SQUARE HOLE

INT. 125
INT. 125
15 Fori per barra
Holes per bar

H.2000 mm. Foro \square 12
Art. 08.059 \neq 30 X 8
Art. 08.060 \neq 30 X 10
Art. 08.061 \neq 35 X 8
Art. 08.062 \neq 35 X 10
Art. 08.063 \neq 40 X 8
Art. 08.064 \neq 40 X 10
H.2000 mm. Foro \square 14
Art. 08.065 \neq 30 X 8
Art. 08.066 \neq 30 X 10
Art. 08.067 \neq 35 X 8
Art. 08.068 \neq 35 X 10
Art. 08.069 \neq 40 X 8
Art. 08.070 \neq 40 X 10
H.2000 mm. Foro \square 16
Art. 08.070.01 \neq 30 X 8
Art. 08.070.02 \neq 30 X 10
Art. 08.070.03 \neq 35 X 8
Art. 08.070.04 \neq 35 X 10
Art. 08.070.05 \neq 40 X 8
Art. 08.070.06 \neq 40 X 10

INT. 112

INT. 112
17 Fori per barra
17 Holes per bar

H. 2000 Foro / Hole \diamond 12
Art. 08.046.100 \neq 30 X 8 mm
H. 2000 Foro / Hole \diamond 14
Art. 08.046.106 \neq 30 X 8 mm
H. 2000 Foro / Hole \diamond 16
Art. 08.046.112 \neq 30 X 8 mm

INT. 112

INT. 112
17 Fori per barra
17 Holes per bar

H. 2000 Foro / Hole \square 12
Art. 08.058.100 \neq 30 X 8 mm
H. 2000 Foro / Hole \square 14
Art. 08.058.106 \neq 30 X 8 mm
H. 2000 Foro / Hole \square 16
Art. 08.058.112 \neq 30 X 8 mm

INT. 112

INT. 112
17 Fori per barra
17 Holes per bar

H. 2000 Foro / Hole \emptyset 12
Art. 08.070.100 \neq 30 X 8 mm
H. 2000 Foro / Hole \emptyset 14
Art. 08.070.106 \neq 30 X 8 mm
H. 2000 Foro / Hole \emptyset 16
Art. 08.070.112 \neq 30 X 8 mm

Le barre forate possono essere prodotte anche da 3000 mm. / Our flat punched bars are also available at 3 meter length.

Tutte le parti di questo catalogo - foto comprese - sono di proprietà Euro-Fer. La riproduzione, anche parziale, è vietata in ogni forma e con ogni mezzo. / Every part of this catalogue - photos included - is Euro-Fer's property. All forms of copying are strictly prohibited.

INT. standard: 125 mm. - n. Fori 15

MISURE STANDARD 2000 mm. / 2000 mm. STANDARD SIZE

INT. = INTERASSE / CENTRE DISTANCE

LUCE = DISTANCE BETWEEN HOLES

FORO = HOLE

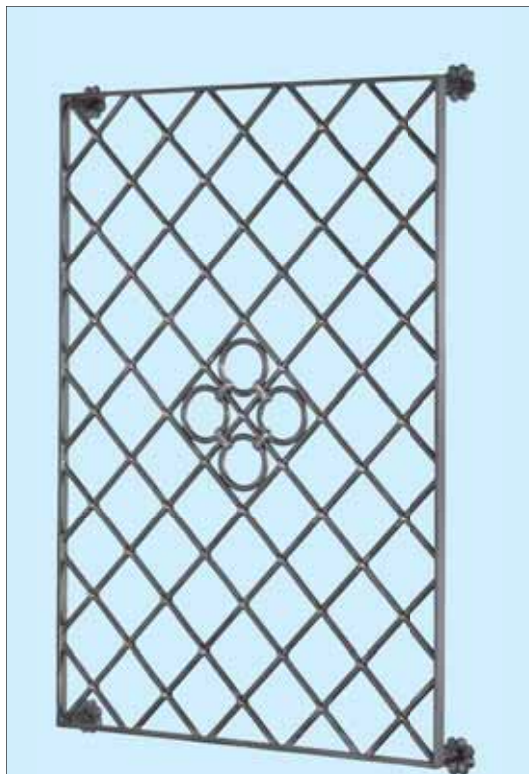
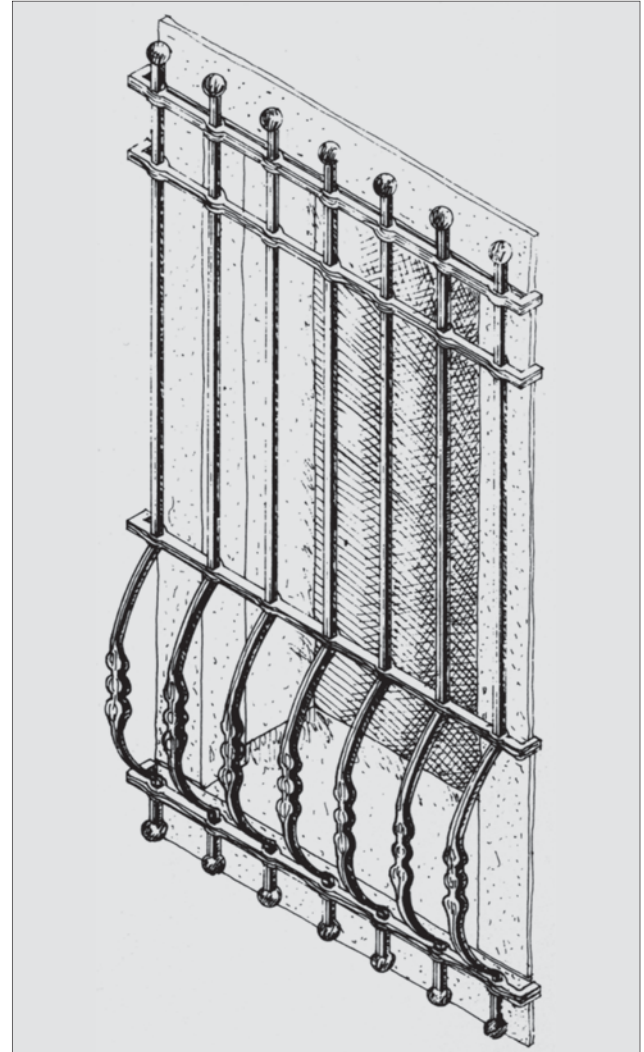
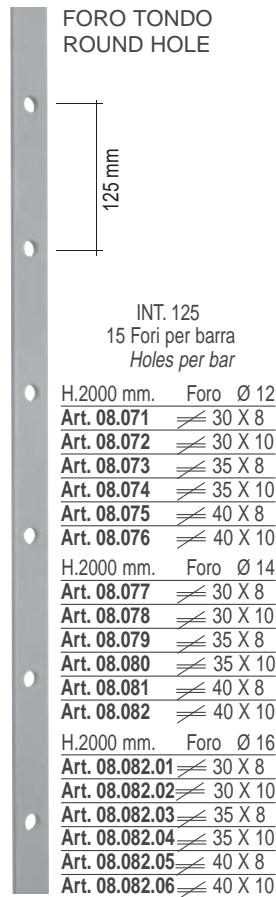
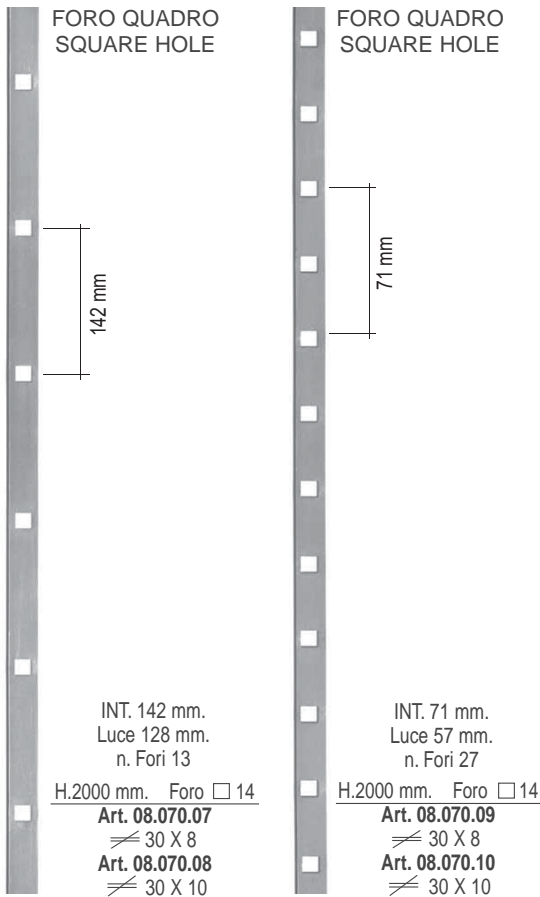

Piatto Martellato 4 Lati / Hammered Flat - 4 Sides

**FORO QUADRO IN OBLIQUO
SLANTING SQUARE HOLE**

INT. 125
15 Fori per barra / Holes per bar

H.2000 mm. Foro ◇ 12
Art. 08.082.20 ≙ 30 X 8
Art. 08.082.21 ≙ 30 X 10
Art. 08.082.22 ≙ 35 X 8
Art. 08.082.23 ≙ 35 X 10
Art. 08.082.24 ≙ 40 X 8
Art. 08.082.25 ≙ 40 X 10

H.2000 mm. Foro ◇ 14
Art. 08.082.26 ≙ 30 X 8
Art. 08.082.27 ≙ 30 X 10
Art. 08.082.28 ≙ 35 X 8
Art. 08.082.29 ≙ 35 X 10
Art. 08.082.30 ≙ 40 X 8
Art. 08.082.31 ≙ 40 X 10

H.2000 mm. Foro ◇ 16
Art. 08.082.32 ≙ 30 X 8
Art. 08.082.33 ≙ 30 X 10
Art. 08.082.34 ≙ 35 X 8
Art. 08.082.35 ≙ 35 X 10
Art. 08.082.36 ≙ 40 X 8
Art. 08.082.37 ≙ 40 X 10

**FORO QUADRO
SQUARE HOLE**

INT. 125
15 Fori per barra / Holes per bar

H.2000 mm. □ 12 X 12
Art. 08.082.38 ≙ 30 X 8
Art. 08.082.39 ≙ 30 X 10
Art. 08.082.40 ≙ 35 X 8
Art. 08.082.41 ≙ 35 X 10
Art. 08.082.42 ≙ 40 X 8
Art. 08.082.43 ≙ 40 X 10

H.2000 mm. □ 14 X 14
Art. 08.082.44 ≙ 30 X 8
Art. 08.082.45 ≙ 30 X 10
Art. 08.082.46 ≙ 35 X 8
Art. 08.082.47 ≙ 35 X 10
Art. 08.082.48 ≙ 40 X 8
Art. 08.082.49 ≙ 40 X 10

H.2000 mm. □ 16 X 16
Art. 08.082.50 ≙ 30 X 8
Art. 08.082.51 ≙ 30 X 10
Art. 08.082.52 ≙ 35 X 8
Art. 08.082.53 ≙ 35 X 10
Art. 08.082.54 ≙ 40 X 8
Art. 08.082.55 ≙ 40 X 10

**FORO TONDO
ROUND HOLE**

INT. 125
15 Fori per barra / Holes per bar

H.2000 mm. Ø 12
Art. 08.082.56 ≙ 30 X 8
Art. 08.082.57 ≙ 30 X 10
Art. 08.082.58 ≙ 35 X 8
Art. 08.082.59 ≙ 35 X 10
Art. 08.082.60 ≙ 40 X 8
Art. 08.082.61 ≙ 40 X 10

H.2000 mm. Ø 14
Art. 08.082.62 ≙ 30 X 8
Art. 08.082.63 ≙ 30 X 10
Art. 08.082.64 ≙ 35 X 8
Art. 08.082.65 ≙ 35 X 10
Art. 08.082.66 ≙ 40 X 8
Art. 08.082.67 ≙ 40 X 10

H.2000 mm. Ø 16
Art. 08.082.68 ≙ 30 X 8
Art. 08.082.69 ≙ 30 X 10
Art. 08.082.70 ≙ 35 X 8
Art. 08.082.71 ≙ 35 X 10
Art. 08.082.72 ≙ 40 X 8
Art. 08.082.73 ≙ 40 X 10

Le barre forate possono essere prodotte anche da 3000 mm. / Our flat punched bars are also available at 3 meter length.

30 x 20 x 2 mm

Tubo liscio / Plain

int. 125 mm - **fori passanti** / int. 125 mm - **fully drilled holes**

H. 2000

Art. 08.082.100	foro Ø 12	nr. 15 fori
Art. 08.082.101	foro Ø 14	nr. 15 fori
Art. 08.082.102	foro □ 12	nr. 15 fori

H. 3000

Art. 08.082.105	foro Ø 12	nr. 23 fori
Art. 08.082.106	foro Ø 14	nr. 23 fori
Art. 08.082.107	foro □ 12	nr. 23 fori

H. 6000

Art. 08.082.110	foro Ø 12	nr. 47 fori
Art. 08.082.111	foro Ø 14	nr. 47 fori
Art. 08.082.112	foro □ 12	nr. 47 fori

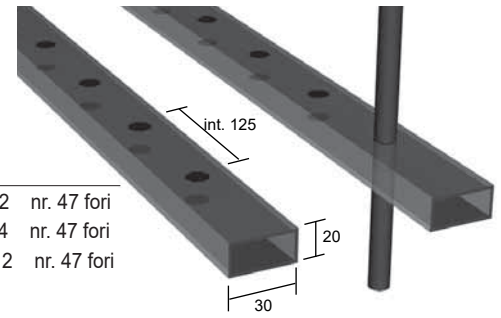

30 x 20 x 2 mm

Tubo liscio / Plain

int. 125 mm - **fori in battuta** / int. 125 mm - **part drilled holes**

H. 2000

Art. 08.082.115	foro Ø 12	nr. 15 fori
Art. 08.082.116	foro □ 12	nr. 15 fori

H. 3000

Art. 08.082.118	foro Ø 12	nr. 23 fori
Art. 08.082.119	foro □ 12	nr. 23 fori

H. 6000

Art. 08.082.121	foro Ø 12	nr. 47 fori
Art. 08.082.122	foro □ 12	nr. 47 fori

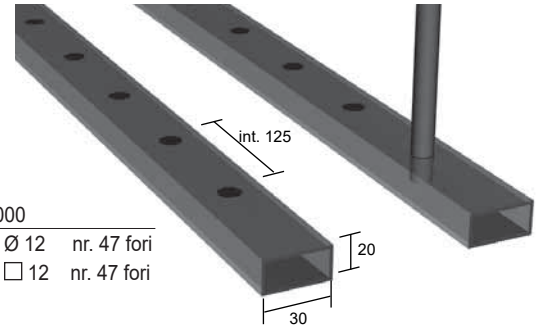

40 x 20 x 2 mm

Tubo liscio / Plain

int. 125 mm - **fori passanti** / int. 125 mm - **fully drilled holes**

H. 2000

Art. 08.082.148	foro Ø 12	nr. 15 fori
Art. 08.082.149	foro Ø 14	nr. 15 fori
Art. 08.082.154	foro □ 12	nr. 15 fori
Art. 08.082.155	foro □ 14	nr. 15 fori

H. 3000

Art. 08.082.163	foro Ø 12	nr. 23 fori
Art. 08.082.164	foro Ø 14	nr. 23 fori
Art. 08.082.169	foro □ 12	nr. 23 fori
Art. 08.082.170	foro □ 14	nr. 23 fori

H. 6000

Art. 08.082.178	foro Ø 12	nr. 47 fori
Art. 08.082.179	foro Ø 14	nr. 47 fori
Art. 08.082.184	foro □ 12	nr. 47 fori
Art. 08.082.185	foro □ 14	nr. 47 fori

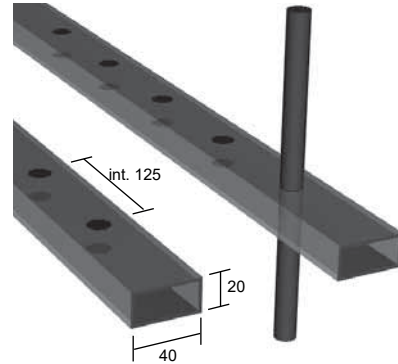

40 x 20 x 2 mm - Tubo liscio / Plain

int. 125 mm - **fori in battuta** / int. 125 mm - **part drilled holes**

H. 2000

Art. 08.082.194	foro Ø 14	nr. 15 fori
Art. 08.082.200	foro □ 14	nr. 15 fori

H. 3000

Art. 08.082.208	foro Ø 14	nr. 23 fori
Art. 08.082.214	foro □ 14	nr. 23 fori

H. 6000

Art. 08.082.222	foro Ø 14	nr. 47 fori
Art. 08.082.228	foro □ 14	nr. 47 fori

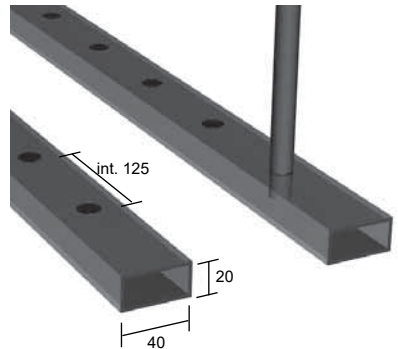

50 x 25 x 2 mm - Tubo liscio / Plain

int. 125 mm - **fori passanti** / int. 125 mm - **fully drilled holes**

H. 2000

Art. 08.082.323	foro Ø 14	nr. 15 fori
Art. 08.082.330	foro □ 14	nr. 15 fori

H. 3000

Art. 08.082.340	foro Ø 14	nr. 23 fori
Art. 08.082.347	foro □ 14	nr. 23 fori

H. 6000

Art. 08.082.357	foro Ø 14	nr. 47 fori
Art. 08.082.364	foro □ 14	nr. 47 fori

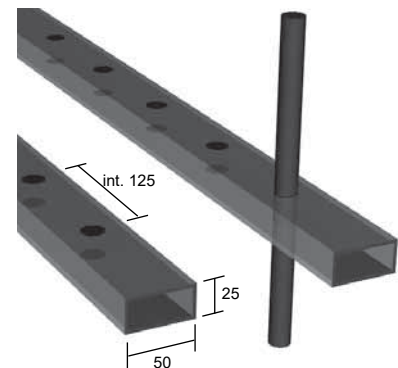

50 x 25 x 2 mm - Tubo liscio / Plain int. 125 mm - fori in battuta / int. 125 mm - part drilled holes

H. 2000

Art. 08.082.374 foro Ø 14 nr. 15 fori
Art. 08.082.381 foro □ 14 nr. 15 fori

H. 3000

Art. 08.082.390 foro Ø 14 nr. 23 fori
Art. 08.082.397 foro □ 14 nr. 23 fori

H. 6000

Art. 08.082.406 foro Ø 14 nr. 47 fori
Art. 08.082.413 foro □ 14 nr. 47 fori

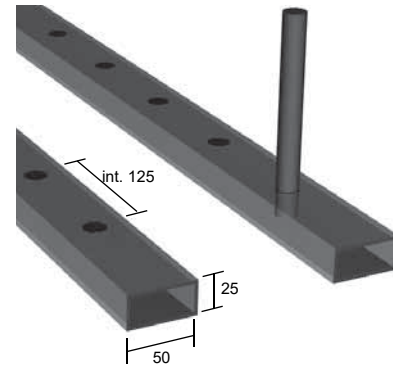

40 x 40 x 3 mm - Tubo liscio / Plain int. 125 mm - fori passanti / int. 125 mm - fully drilled holes

H. 2000

Art. 08.082.510 foro Ø 12 nr. 15 fori
Art. 08.082.511 foro Ø 14 nr. 15 fori
Art. 08.082.512 foro □ 12 nr. 15 fori
Art. 08.082.513 foro □ 14 nr. 15 fori

H. 3000

Art. 08.082.520 foro Ø 12 nr. 23 fori
Art. 08.082.521 foro Ø 14 nr. 23 fori
Art. 08.082.522 foro □ 12 nr. 23 fori
Art. 08.082.523 foro □ 14 nr. 23 fori

H. 6000

Art. 08.082.530 foro Ø 12 nr. 47 fori
Art. 08.082.531 foro Ø 14 nr. 47 fori
Art. 08.082.532 foro □ 12 nr. 47 fori
Art. 08.082.533 foro □ 14 nr. 47 fori

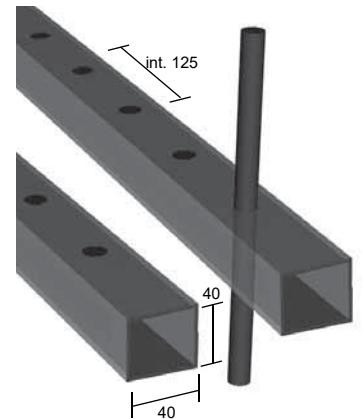

Su richiesta è possibile realizzare tubi forati di diverse lunghezze e con diverse misure di interasse
Customized sizes and dimensions available on demand

Per realizzare un tubo forato a misura dovete indicare /
For customized items please indicate:

Tipo di tubo / Type of tube

- 30x20 x 2mm Tubo Liscio / Plain
- 40x20 x 2mm Tubo Liscio / Plain
- 40x40 x 3mm Tubo Liscio / Plain
- 50x25 x 2mm Tubo Liscio / Plain

■ fori passanti / fully drilled holes

■ fori in battuta / part drilled holes

□ Numero dei fori / Number of holes

Tipo di fori e dimensioni / Kind and sizes of hole

□ □ □ mm

Ø □ □ mm

□ Lunghezza tubo / Tube lenght

□ Int. A / Int. A

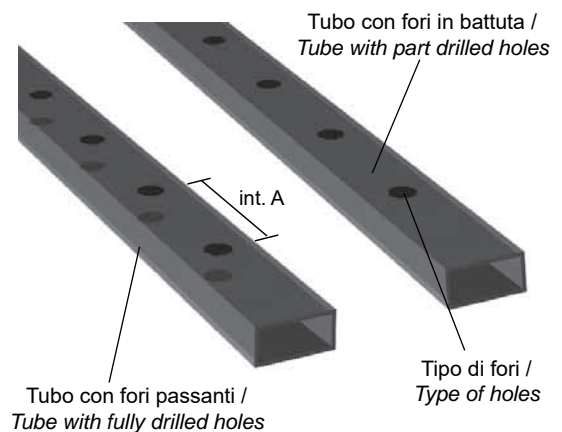

Cliente

Data

Timbro e Firma

Note

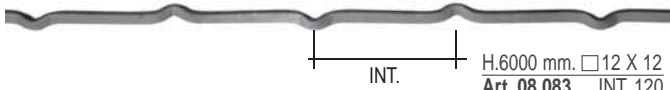

H.6000 mm. □ 12 X 12	
Art. 08.083	INT. 120
Art. 08.084	INT. 140
Art. 08.085	INT. 160
Art. 08.086	INT. 180
Art. 08.087	INT. 200
Art. 08.088	INT. 300
H.6000 mm. □ 14 X 14	
Art. 08.089	INT. 120
Art. 08.090	INT. 140
Art. 08.091	INT. 160
Art. 08.092	INT. 180
Art. 08.093	INT. 200
Art. 08.094	INT. 300



H.2000 mm. ≠ 20x4	
Art. 08.094.50	INT. 120
Art. 08.094.51	INT. 160

Esempio / Example

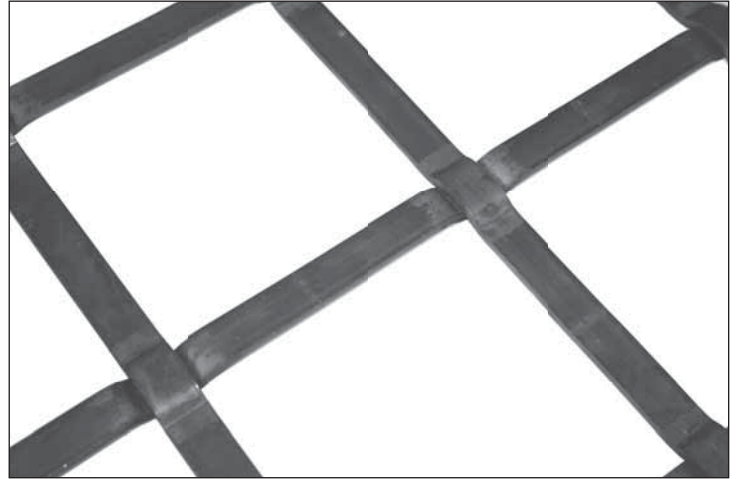

SALISBURGHESI

LE BARRE "SALISBURGHESI" SONO FORNITE SINGOLARMENTE: SONO ACCOPPIATE SOLO A TITOLO DIMOSTRATIVO.
THE "SALISBURGHESI" BARS ARE SUPPLIED SEPARATELY: THEY ARE ONLY IN PAIRS FOR DEMONSTRATION PURPOSES.

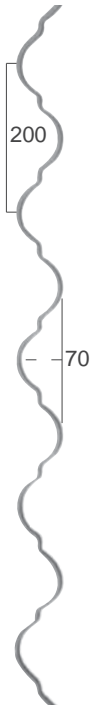

H.2500 X L.70 mm.
Art. 08.095
≠ 16 X 5



H.2500 X L.70 mm.
Art. 08.096 ≠ 16 X 8
Rigato / Striped

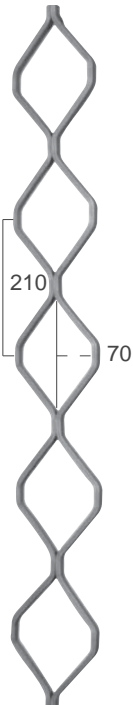

H.2500 X L.70 mm.
Art. 08.097 ≠ 16 X 8
Rigato / Striped



H.2500 X L.75 mm.
Art. 08.098 ≠ 16 X 8
Art. 08.099 Ø 10
Art. 08.100 Ø 12

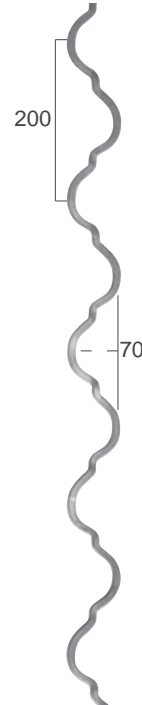

H.2500 X L.70 mm.
Art. 08.101 □ 8
Art. 08.102 □ 10
Art. 08.103 □ 12

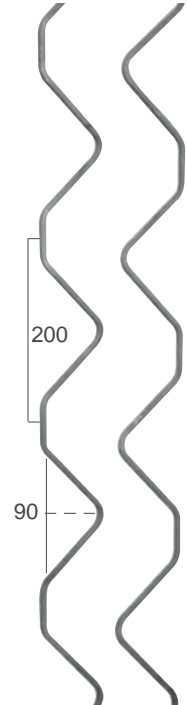

H.2500 X L.90 mm.
Art. 08.104
□ 8 X 8



Spazio per inserimento □ 14 mm.
Space for square insert □ 14 mm.

FORO
OBLIQUO
SLANTING
HOLE

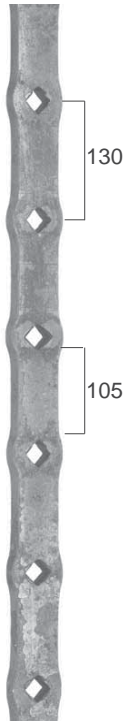

H.2000 mm. ≙ 50 X 20
Art. 08.105.02 INT.130 mm.
Luce 105 mm.
N. Fori / Holes 14 ◊ 22

Martellato / Hammered
H.2000 mm. □ 14 X 14
Art. 08.105 INT.125 mm.
N. Nocchie / Knobs 16

Liscio / Smooth
H.2000 mm. □ 14 X 14
Art. 08.105.01 INT.125 mm.
N. Nocchie / Knobs 16

PIATTI CON RIBATTINI STAMPATI
PLAT BARS WITH FORGED RIVETS



PIATTO LISCIO
SMOOTH FLAT

H.2000 mm.
Art. 08.182
≙ 30 X 6
INT. 125 mm.



PIATTO
MARTELLATO
HAMMERED
FLAT

H.2000 mm.
Art. 08.183
≙ 30 X 6
INT. 125 mm.



PIATTO
SAGOMATO
MODELLED
FLAT

H.2000 mm.
Art. 08.184
≙ 30 X 8
INT. 132 mm.

H.3000 mm.
Art. 08.184.01
≙ 30 X 8
INT. 132 mm.



Liscio / Smooth
Foro ad asola / Buttonhole
H.2000 mm ≙ 40 x 8 mm

- Art. 08.199 fori / hole □ 12 mm - int. 130 mm - n°14 fori / holes
- Art. 08.199.01 fori / hole □ 12 mm - int. 135 mm - n°14 fori / holes
- Art. 08.199.02 fori / hole □ 14 mm - int. 130 mm - n°14 fori / holes
- Art. 08.199.03 fori / hole □ 14 mm - int. 135 mm - n°14 fori / holes
- Art. 08.200 fori / hole □ 16 mm - int. 130 mm - n°14 fori / holes
- Art. 08.200.01 fori / hole □ 16 mm - int. 135 mm - n°14 fori / holes



Martellato / Hammered
Foro ad asola / Buttonhole
H.2000 mm ≙ 40 x 8 mm

- Art. 08.200.10 fori / hole □ 12 mm - int. 130 mm - n°14 fori / holes
- Art. 08.200.11 fori / hole □ 12 mm - int. 135 mm - n°14 fori / holes
- Art. 08.200.12 fori / hole □ 14 mm - int. 130 mm - n°14 fori / holes
- Art. 08.200.13 fori / hole □ 14 mm - int. 135 mm - n°14 fori / holes
- Art. 08.201 fori / hole □ 16 mm - int. 130 mm - n°14 fori / holes
- Art. 08.201.01 fori / hole □ 16 mm - int. 135 mm - n°14 fori / holes



Liscio / Smooth
H.2000 mm ≙ 30 x 5 mm
Art. 08.210 □ 14 mm - int. 130 mm
Art. 08.211 □ 14 mm - int. 145 mm

Liscio / Smooth
H.2000 mm ≙ 30 x 5 mm
Art. 08.214 □ 16 mm - int. 130 mm
Art. 08.215 □ 16 mm - int. 145 mm

Liscio / Smooth
H.3000 mm ≙ 30 x 5 mm
Art. 08.212 □ 14 mm - int. 130 mm
Art. 08.213 □ 14 mm - int. 145 mm

Liscio / Smooth
H.3000 mm ≙ 30 x 5 mm
Art. 08.216 □ 16 mm - int. 130 mm
Art. 08.217 □ 16 mm - int. 145 mm

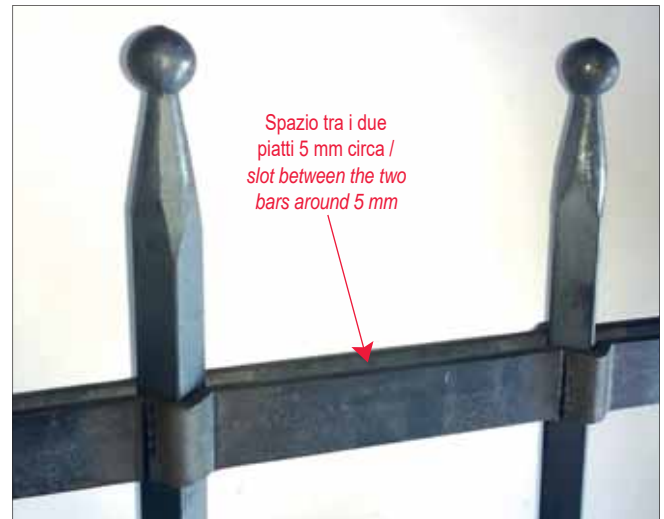

Spazio tra i due
piatti 5 mm circa /
slot between the two
bars around 5 mm



H.950 mm.
Art. 09.001 12
Art. 09.002 14
Art. 09.003 16

H.1000 mm.
Art. 09.004 12
Art. 09.005 14
Art. 09.006 16

H.1200 mm.
Art. 09.007 12
Art. 09.008 14
Art. 09.009 16



H.950 mm.
Art. 09.010 12
Art. 09.011 14
Art. 09.012 16

H.1000 mm.
Art. 09.013 12
Art. 09.014 14
Art. 09.015 16

H.1200 mm.
Art. 09.016 12
Art. 09.017 14
Art. 09.018 16



H.400 mm.
Art. 09.019 12
Art. 09.020 14
Art. 09.021 16

H.500 mm.
Art. 09.022 12
Art. 09.023 14
Art. 09.024 16

H.600 mm.
Art. 09.025 12
Art. 09.026 14
Art. 09.027 16

H.700 mm.
Art. 09.028 12
Art. 09.029 14
Art. 09.030 16



H.800 mm.
Art. 09.031 12
Art. 09.032 14
Art. 09.033 16

H.900 mm.
Art. 09.034 12
Art. 09.035 14
Art. 09.036 16

H.1000 mm.
Art. 09.037 12
Art. 09.038 14
Art. 09.039 16

H.1200 mm.
Art. 09.040 12
Art. 09.041 14
Art. 09.042 16



H.950 mm.
Art. 09.043 12
Art. 09.044 14
Art. 09.045 16

H.1000 mm.
Art. 09.046 12
Art. 09.047 14
Art. 09.048 16

H.1200 mm.
Art. 09.049 12
Art. 09.050 14
Art. 09.051 16



H.1300 mm.
Art. 09.052 12
Art. 09.053 14
Art. 09.054 16

H.1400 mm.
Art. 09.055 12
Art. 09.056 14
Art. 09.057 16

H.1500 mm.
Art. 09.058 12
Art. 09.059 14
Art. 09.060 16



H.950 mm.
Art. 09.067 12
Art. 09.068 14
Art. 09.069 16

H.1000 mm.
Art. 09.070 12
Art. 09.071 14
Art. 09.072 16

H.1200 mm.
Art. 09.073 12
Art. 09.074 14
Art. 09.075 16



H.950 mm.
Art. 09.076 12
Art. 09.077 14
Art. 09.078 16

H.1000 mm.
Art. 09.079 12
Art. 09.080 14
Art. 09.081 16

H.1200 mm.
Art. 09.082 12
Art. 09.083 14
Art. 09.084 16



H.950 mm.
Art. 09.085 12
Art. 09.086 14
Art. 09.087 16

H.1000 mm.
Art. 09.088 12
Art. 09.089 14
Art. 09.090 16

H.1200 mm.
Art. 09.091 12
Art. 09.092 14
Art. 09.093 16

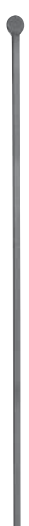

H.950 mm.
Art. 09.094 12
Art. 09.095 14
Art. 09.096 16

H.1000 mm.
Art. 09.097 12
Art. 09.098 14
Art. 09.099 16

H.1200 mm.
Art. 09.100 12
Art. 09.101 14
Art. 09.102 16



H.950 mm.
Art. 09.094.01 12
Art. 09.095.01 14
Art. 09.096.01 16

H.1000 mm.
Art. 09.097.01 12
Art. 09.098.01 14
Art. 09.099.01 16

H.1200 mm.
Art. 09.100.01 12
Art. 09.101.01 14
Art. 09.102.01 16



H.950 mm.
Art. 09.103 12
Art. 09.104 14
Art. 09.105 16

H.1000 mm.
Art. 09.106 12
Art. 09.107 14
Art. 09.108 16

H.1200 mm.
Art. 09.109 12
Art. 09.110 14
Art. 09.111 16



H.950 mm.
Art. 09.115 12
Art. 09.116 14
Art. 09.117 16

H.1000 mm.
Art. 09.118 12
Art. 09.119 14
Art. 09.120 16

H.1200 mm.
Art. 09.121 12
Art. 09.122 14
Art. 09.123 16



H.950 mm.
Art. 09.127 12
Art. 09.128 14
Art. 09.129 16

H.1000 mm.
Art. 09.130 12
Art. 09.131 14
Art. 09.132 16

H.1200 mm.
Art. 09.133 12
Art. 09.134 14
Art. 09.135 16



H.950 mm.
Art. 09.139 12
Art. 09.140 14
Art. 09.141 16

H.1000 mm.
Art. 09.142 12
Art. 09.143 14
Art. 09.144 16

H.1200 mm.
Art. 09.145 12
Art. 09.146 14
Art. 09.147 16



H.950 mm.
Art. 09.151 12
Art. 09.152 14
Art. 09.153 16

H.1000 mm.
Art. 09.154 12
Art. 09.155 14
Art. 09.156 16

H.1200 mm.
Art. 09.157 12
Art. 09.158 14
Art. 09.159 16

H.1500 mm.
Art. 09.112 12
Art. 09.113 14
Art. 09.114 16

H.1500 mm.
Art. 09.124 12
Art. 09.125 14
Art. 09.126 16

H.1500 mm.
Art. 09.136 12
Art. 09.137 14
Art. 09.138 16

H.1500 mm.
Art. 09.148 12
Art. 09.149 14
Art. 09.150 16

H.1500 mm.
Art. 09.160 12
Art. 09.161 14
Art. 09.162 16

Tutte le parti di questo catalogo - foto comprese - sono di proprietà Euro-Fer. La riproduzione, anche parziale, è vietata in ogni forma e con ogni mezzo. / Every part of this catalogue - photos included - is Euro-Fer's property. All forms of copying are strictly prohibited.

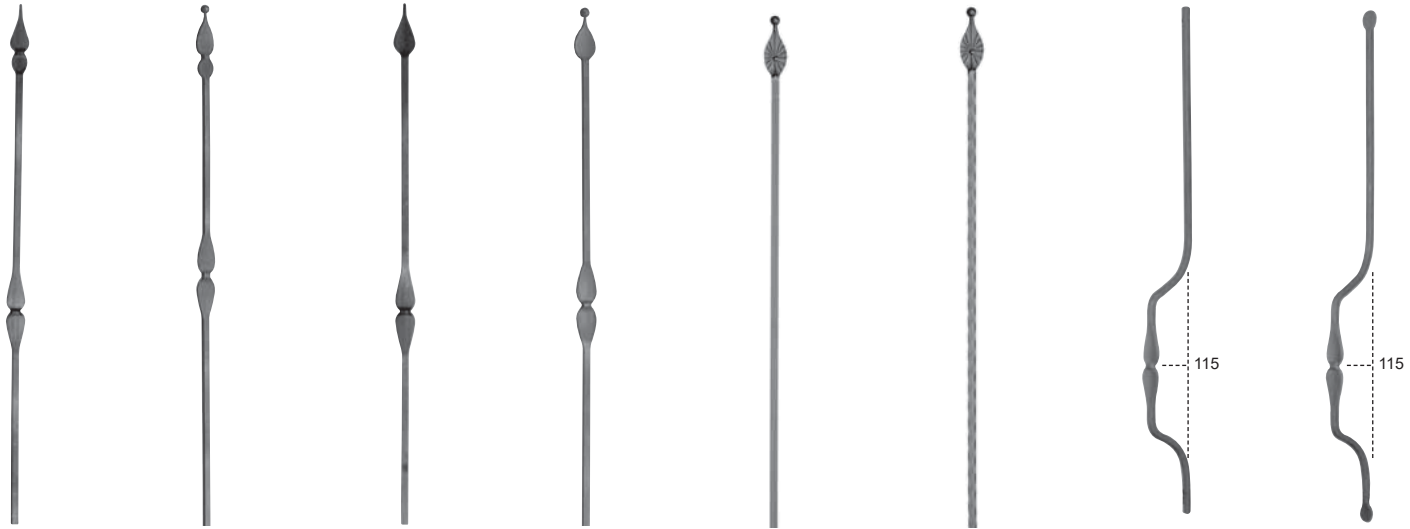

H.950 mm.
Art. 09.163 12
Art. 09.164 14
Art. 09.165 16

H.1000 mm.
Art. 09.166 12
Art. 09.167 14
Art. 09.168 16

H.1200 mm.
Art. 09.169 12
Art. 09.170 14
Art. 09.171 16

H.1500 mm.
Art. 09.172 12
Art. 09.173 14
Art. 09.174 16

H.950 mm.
Art. 09.163.01 12
Art. 09.164.01 14
Art. 09.165.01 16

H.1000 mm.
Art. 09.166.01 12
Art. 09.167.01 14
Art. 09.168.01 16

H.1200 mm.
Art. 09.169.01 12
Art. 09.170.01 14
Art. 09.171.01 16

H.1500 mm.
Art. 09.172.01 12
Art. 09.173.01 14
Art. 09.174.01 16

H.950 mm.
Art. 09.175 12
Art. 09.176 14
Art. 09.177 16

H.1000 mm.
Art. 09.178 12
Art. 09.179 14
Art. 09.180 16

H.1200 mm.
Art. 09.181 12
Art. 09.182 14
Art. 09.183 16

H.1500 mm.
Art. 09.184 12
Art. 09.185 14
Art. 09.186 16

H.950 mm.
Art. 09.175.01 12
Art. 09.176.01 14
Art. 09.177.01 16

H.1000 mm.
Art. 09.178.01 12
Art. 09.179.01 14
Art. 09.180.01 16

H.1200 mm.
Art. 09.181.01 12
Art. 09.182.01 14
Art. 09.183.01 16

H.1500 mm.
Art. 09.184.01 12
Art. 09.185.01 14
Art. 09.186.01 16

H.950 mm.
Art. 09.186.02 12
Art. 09.186.03 14
Art. 09.186.04 16

H.1000 mm.
Art. 09.186.05 12
Art. 09.186.06 14
Art. 09.186.07 16

H.1200 mm.
Art. 09.186.08 12
Art. 09.186.09 14
Art. 09.186.10 16

H.1500 mm.
Art. 09.186.11 12
Art. 09.186.12 14
Art. 09.186.13 16

Martellato / Hammered
H.950 mm.
Art. 09.186.14 12
Art. 09.186.15 14
Art. 09.186.16 16

H.1000 mm.
Art. 09.186.17 12
Art. 09.186.18 14
Art. 09.186.19 16

H.1200 mm.
Art. 09.186.20 12
Art. 09.186.21 14
Art. 09.186.22 16

H.1500 mm.
Art. 09.186.23 12
Art. 09.186.24 14
Art. 09.186.25 16

H.950 mm.
Art. 09.187 12
Art. 09.188 14
Art. 09.189 16

H.1000 mm.
Art. 09.190 12
Art. 09.191 14
Art. 09.192 16

H.1200 mm.
Art. 09.193 12
Art. 09.194 14
Art. 09.195 16

H.1500 mm.
Art. 09.196 12
Art. 09.197 14
Art. 09.198 16

H.950 mm.
Art. 09.199 12
Art. 09.200 14
Art. 09.201 16

H.1000 mm.
Art. 09.202 12
Art. 09.203 14
Art. 09.204 16

H.1200 mm.
Art. 09.205 12
Art. 09.206 14
Art. 09.207 16

H.1500 mm.
Art. 09.208 12
Art. 09.209 14
Art. 09.210 16



H.950 mm.
Art. 09.211 12
Art. 09.212 14
Art. 09.213 16

H.1000 mm.
Art. 09.214 12
Art. 09.215 14
Art. 09.216 16

H.1200 mm.
Art. 09.217 12
Art. 09.218 14
Art. 09.219 16

H.1800 mm.
Art. 09.219.50 14
Art. 09.219.51 16

H.2000 mm.
Art. 09.219.52 14
Art. 09.219.53 16

H.950 mm.
Art. 09.220 12
Art. 09.221 14
Art. 09.222 16

H.1000 mm.
Art. 09.223 12
Art. 09.224 14
Art. 09.225 16

H.1200 mm.
Art. 09.226 12
Art. 09.227 14
Art. 09.228 16

H.400 mm.
Art. 09.229 12
Art. 09.230 14
Art. 09.231 16

H.500 mm.
Art. 09.232 12
Art. 09.233 14
Art. 09.234 16

H.600 mm.
Art. 09.235 12
Art. 09.236 14
Art. 09.237 16

H.700 mm.
Art. 09.238 12
Art. 09.239 14
Art. 09.240 16

H.800 mm.
Art. 09.241 12
Art. 09.242 14
Art. 09.243 16

H.900 mm.
Art. 09.244 12
Art. 09.245 14
Art. 09.246 16

H.1000 mm.
Art. 09.247 12
Art. 09.248 14
Art. 09.249 16

H.1200 mm.
Art. 09.250 12
Art. 09.251 14
Art. 09.252 16

H.950 mm.
Art. 09.253 12
Art. 09.254 14
Art. 09.255 16

H.1000 mm.
Art. 09.256 12
Art. 09.257 14
Art. 09.258 16

H.1200 mm.
Art. 09.259 12
Art. 09.260 14
Art. 09.261 16

H.1500 mm.
Art. 09.262 12
Art. 09.263 14
Art. 09.264 16

H.1300 mm.
Art. 09.265 12
Art. 09.266 14
Art. 09.267 16

















H.1400 mm.
Art. 09.268 12
Art. 09.269 14
Art. 09.270 16

H.950 mm.
Art. 09.280 12
Art. 09.281 14
Art. 09.282 16

H.1000 mm.
Art. 09.283 12
Art. 09.284 14
Art. 09.285 16

H.1200 mm.
Art. 09.286 12
Art. 09.287 14
Art. 09.288 16

H.1500 mm.
Art. 09.289 12
Art. 09.290 14
Art. 09.291 16

							
H.950 mm. Art. 09.292 □ 12 Art. 09.293 □ 14 Art. 09.294 □ 16	H.950 mm. Art. 09.304 □ 12 Art. 09.305 □ 14 Art. 09.306 □ 16	H.950 mm. Art. 09.319 □ 12 Art. 09.320 □ 14 Art. 09.321 □ 16	H.950 mm. Art. 09.334 □ 12 Art. 09.335 □ 14 Art. 09.336 □ 16	H.950 mm. Art. 09.349 □ 12 Art. 09.350 □ 14 Art. 09.351 □ 16	H.950 mm. Art. 09.364 □ 12 Art. 09.365 □ 14 Art. 09.366 □ 16	H.950 mm. Art. 09.379 □ 12 Art. 09.380 □ 14 Art. 09.381 □ 16	H.950 mm. Art. 09.394 □ 12 Art. 09.395 □ 14 Art. 09.396 □ 16
H.1000 mm. Art. 09.295 □ 12 Art. 09.296 □ 14 Art. 09.297 □ 16	H.1000 mm. Art. 09.307 □ 12 Art. 09.308 □ 14 Art. 09.309 □ 16	H.1000 mm. Art. 09.322 □ 12 Art. 09.323 □ 14 Art. 09.324 □ 16	H.1000 mm. Art. 09.337 □ 12 Art. 09.338 □ 14 Art. 09.339 □ 16	H.1000 mm. Art. 09.352 □ 12 Art. 09.353 □ 14 Art. 09.354 □ 16	H.1000 mm. Art. 09.367 □ 12 Art. 09.368 □ 14 Art. 09.369 □ 16	H.1000 mm. Art. 09.382 □ 12 Art. 09.383 □ 14 Art. 09.384 □ 16	H.1000 mm. Art. 09.397 □ 12 Art. 09.398 □ 14 Art. 09.399 □ 16
H.1200 mm. Art. 09.298 □ 12 Art. 09.299 □ 14 Art. 09.300 □ 16	H.1200 mm. Art. 09.310 □ 12 Art. 09.311 □ 14 Art. 09.312 □ 16	H.1200 mm. Art. 09.325 □ 12 Art. 09.326 □ 14 Art. 09.327 □ 16	H.1200 mm. Art. 09.340 □ 12 Art. 09.341 □ 14 Art. 09.342 □ 16	H.1200 mm. Art. 09.355 □ 12 Art. 09.356 □ 14 Art. 09.357 □ 16	H.1200 mm. Art. 09.370 □ 12 Art. 09.371 □ 14 Art. 09.372 □ 16	H.1200 mm. Art. 09.385 □ 12 Art. 09.386 □ 14 Art. 09.387 □ 16	H.1200 mm. Art. 09.400 □ 12 Art. 09.401 □ 14 Art. 09.402 □ 16
H.1500 mm. Art. 09.301 □ 12 Art. 09.302 □ 14 Art. 09.303 □ 16	H.1500 mm. Art. 09.313 □ 12 Art. 09.314 □ 14 Art. 09.315 □ 16	H.1500 mm. Art. 09.328 □ 12 Art. 09.329 □ 14 Art. 09.330 □ 16	H.1500 mm. Art. 09.343 □ 12 Art. 09.344 □ 14 Art. 09.345 □ 16	H.1500 mm. Art. 09.358 □ 12 Art. 09.359 □ 14 Art. 09.360 □ 16	H.1500 mm. Art. 09.373 □ 12 Art. 09.374 □ 14 Art. 09.375 □ 16	H.1500 mm. Art. 09.388 □ 12 Art. 09.389 □ 14 Art. 09.390 □ 16	H.1500 mm. Art. 09.403 □ 12 Art. 09.404 □ 14 Art. 09.405 □ 16
H.1800 mm. Art. 09.316 □ 12 Art. 09.317 □ 14 Art. 09.318 □ 16	H.1800 mm. Art. 09.331 □ 12 Art. 09.332 □ 14 Art. 09.333 □ 16	H.1800 mm. Art. 09.346 □ 12 Art. 09.347 □ 14 Art. 09.348 □ 16	H.1800 mm. Art. 09.361 □ 12 Art. 09.362 □ 14 Art. 09.363 □ 16	H.1800 mm. Art. 09.376 □ 12 Art. 09.377 □ 14 Art. 09.378 □ 16	H.1800 mm. Art. 09.391 □ 12 Art. 09.392 □ 14 Art. 09.393 □ 16	H.1800 mm. Art. 09.406 □ 12 Art. 09.407 □ 14 Art. 09.408 □ 16	H.1800 mm. Art. 09.421 □ 12 Art. 09.422 □ 14 Art. 09.423 □ 16
							
H.950 mm. Art. 09.406 □ 12 Art. 09.407 □ 14 Art. 09.408 □ 16	H.950 mm. Art. 09.418 □ 12 Art. 09.419 □ 14 Art. 09.420 □ 16	H.950 mm. Art. 09.430 □ 12 Art. 09.431 □ 14 Art. 09.432 □ 16	H.950 mm. Art. 09.442 □ 12 Art. 09.443 □ 14 Art. 09.444 □ 16	H.950 mm. Art. 09.442.01 □ 12 Art. 09.443.01 □ 14 Art. 09.444.01 □ 16	H.950 mm. Art. 09.454 □ 12 Art. 09.455 □ 14 Art. 09.456 □ 16	H.950 mm. Art. 09.457 □ 12 Art. 09.458 □ 14 Art. 09.459 □ 16	H.950 mm. Art. 09.454.01 □ 12 Art. 09.455.01 □ 14 Art. 09.456.01 □ 16
H.1000 mm. Art. 09.409 □ 12 Art. 09.410 □ 14 Art. 09.411 □ 16	H.1000 mm. Art. 09.421 □ 12 Art. 09.422 □ 14 Art. 09.423 □ 16	H.1000 mm. Art. 09.433 □ 12 Art. 09.434 □ 14 Art. 09.435 □ 16	H.1000 mm. Art. 09.445 □ 12 Art. 09.446 □ 14 Art. 09.447 □ 16	H.1000 mm. Art. 09.445.01 □ 12 Art. 09.446.01 □ 14 Art. 09.447.01 □ 16	H.1000 mm. Art. 09.457 □ 12 Art. 09.458 □ 14 Art. 09.459 □ 16	H.1000 mm. Art. 09.457 □ 12 Art. 09.458 □ 14 Art. 09.459 □ 16	H.1000 mm. Art. 09.457.01 □ 12 Art. 09.458.01 □ 14 Art. 09.459.01 □ 16
H.1200 mm. Art. 09.412 □ 12 Art. 09.413 □ 14 Art. 09.414 □ 16	H.1200 mm. Art. 09.424 □ 12 Art. 09.425 □ 14 Art. 09.426 □ 16	H.1200 mm. Art. 09.436 □ 12 Art. 09.437 □ 14 Art. 09.438 □ 16	H.1200 mm. Art. 09.448 □ 12 Art. 09.449 □ 14 Art. 09.450 □ 16	H.1200 mm. Art. 09.448.01 □ 12 Art. 09.449.01 □ 14 Art. 09.450.01 □ 16	H.1200 mm. Art. 09.460 □ 12 Art. 09.461 □ 14 Art. 09.462 □ 16	H.1200 mm. Art. 09.460 □ 12 Art. 09.461 □ 14 Art. 09.462 □ 16	H.1200 mm. Art. 09.460.01 □ 12 Art. 09.461.01 □ 14 Art. 09.462.01 □ 16
H.1500 mm. Art. 09.415 □ 12 Art. 09.416 □ 14 Art. 09.417 □ 16	H.1500 mm. Art. 09.427 □ 12 Art. 09.428 □ 14 Art. 09.429 □ 16	H.1500 mm. Art. 09.439 □ 12 Art. 09.440 □ 14 Art. 09.441 □ 16	H.1500 mm. Art. 09.451 □ 12 Art. 09.452 □ 14 Art. 09.453 □ 16	H.1500 mm. Art. 09.451.01 □ 12 Art. 09.452.01 □ 14 Art. 09.453.01 □ 16	H.1500 mm. Art. 09.463 □ 12 Art. 09.464 □ 14 Art. 09.465 □ 16	H.1500 mm. Art. 09.463 □ 12 Art. 09.464 □ 14 Art. 09.465 □ 16	H.1500 mm. Art. 09.463.01 □ 12 Art. 09.464.01 □ 14 Art. 09.465.01 □ 16

Tutte le parti di questo catalogo - foto comprese - sono di proprietà Euro-Fer. La riproduzione, anche parziale, è vietata in ogni forma e con ogni mezzo. / Every part of this catalogue - photos included - is Euro-Fer's property. All forms of copying are strictly prohibited.



H.950 X L.175 mm.
Art. 09.466
□ 12 ≙ 12 X 6



H.950 X L.175 mm.
Art. 09.467
□ 12 ≙ 12 X 6



H.950 X L.150 mm.
Art. 09.468
□ 12 ≙ 12 X 6



Martel. / Hammered
H.950 mm.
Art. 09.468.01 □ 12
Art. 09.468.02 □ 14
Art. 09.468.03 □ 16



Martel. / Hammered
H.950 mm.
Art. 09.468.13 □ 12
Art. 09.468.14 □ 14
Art. 09.468.15 □ 16



Martel. / Hammered
H.950 mm.
Art. 09.468.25 □ 12
Art. 09.468.26 □ 14
Art. 09.468.27 □ 16



Martel. / Hammered
H.950 mm.
Art. 09.468.37 □ 12
Art. 09.468.38 □ 14
Art. 09.468.39 □ 16



Martel. / Hammered
H.950 mm.
Art. 09.468.49 □ 12
Art. 09.468.50 □ 14
Art. 09.468.51 □ 16

H.1000 mm.
Art. 09.468.04 □ 12
Art. 09.468.05 □ 14
Art. 09.468.06 □ 16

H.1000 mm.
Art. 09.468.16 □ 12
Art. 09.468.17 □ 14
Art. 09.468.18 □ 16

H.1200 mm.
Art. 09.468.07 □ 12
Art. 09.468.08 □ 14
Art. 09.468.09 □ 16

H.1200 mm.
Art. 09.468.19 □ 12
Art. 09.468.20 □ 14
Art. 09.468.21 □ 16

H.1500 mm.
Art. 09.468.10 □ 12
Art. 09.468.11 □ 14
Art. 09.468.12 □ 16

H.1500 mm.
Art. 09.468.22 □ 12
Art. 09.468.23 □ 14
Art. 09.468.24 □ 16



Martel. / Hammered
H.950 mm.
Art. 09.468.61 □ 12
Art. 09.468.62 □ 14
Art. 09.468.63 □ 16



Martel. / Hammered
H.950 mm.
Art. 09.468.73 □ 12
Art. 09.468.74 □ 14
Art. 09.468.75 □ 16



Tondo / Round
H.950 mm.
Art. 09.469 Ø 14
Art. 09.470 Ø 16
H.1000 mm.
Art. 09.471 Ø 14
Art. 09.472 Ø 16
H.1200 mm.
Art. 09.473 Ø 14
Art. 09.474 Ø 16
H.1500 mm.
Art. 09.475 Ø 14
Art. 09.476 Ø 16



Tondo / Round
H.950 mm.
Art. 09.469.01 Ø 14
Art. 09.470.01 Ø 16
H.1000 mm.
Art. 09.471.01 Ø 14
Art. 09.472.01 Ø 16
H.1200 mm.
Art. 09.473.01 Ø 14
Art. 09.474.01 Ø 16
H.1500 mm.
Art. 09.475.01 Ø 14
Art. 09.476.01 Ø 16



Tondo / Round
H.950 mm.
Art. 09.477 Ø 14
Art. 09.478 Ø 16
H.1000 mm.
Art. 09.479 Ø 14
Art. 09.480 Ø 16
H.1200 mm.
Art. 09.481 Ø 14
Art. 09.482 Ø 16
H.1500 mm.
Art. 09.483 Ø 14
Art. 09.484 Ø 16



Tondo / Round
H.950 mm.
Art. 09.485 Ø 14
Art. 09.486 Ø 16
H.1000 mm.
Art. 09.487 Ø 14
Art. 09.488 Ø 16
H.1200 mm.
Art. 09.489 Ø 14
Art. 09.490 Ø 16
H.1500 mm.
Art. 09.491 Ø 14
Art. 09.492 Ø 16



Tondo / Round
H.950 mm.
Art. 09.485.01 Ø 14
Art. 09.486.01 Ø 16
H.1000 mm.
Art. 09.487.01 Ø 14
Art. 09.488.01 Ø 16
H.1200 mm.
Art. 09.489.01 Ø 14
Art. 09.490.01 Ø 16
H.1500 mm.
Art. 09.491.01 Ø 14
Art. 09.492.01 Ø 16

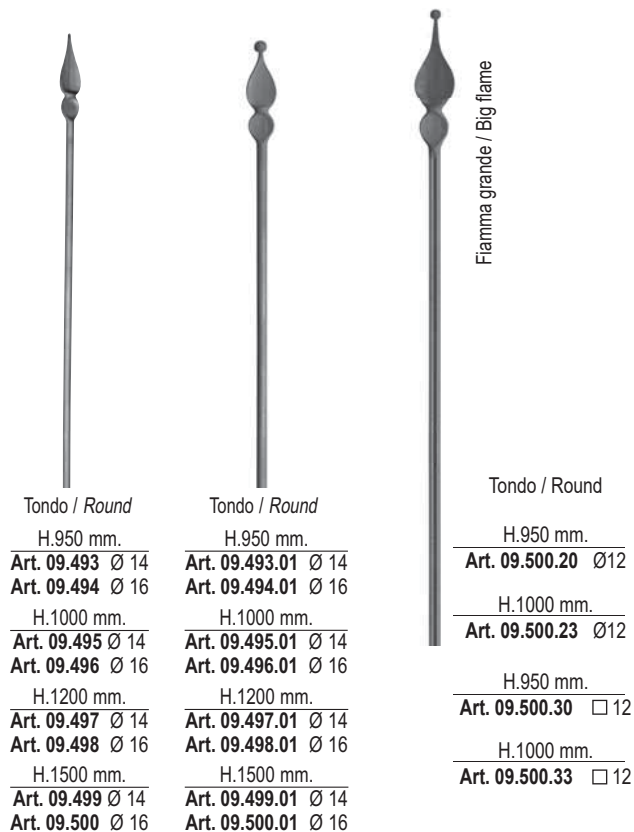

Tondo / Round

H.950 mm.
Art. 09.493 Ø 14
Art. 09.494 Ø 16

H.1000 mm.
Art. 09.495 Ø 14
Art. 09.496 Ø 16

H.1200 mm.
Art. 09.497 Ø 14
Art. 09.498 Ø 16

H.1500 mm.
Art. 09.499 Ø 14
Art. 09.500 Ø 16

Tondo / Round

H.950 mm.
Art. 09.493.01 Ø 14
Art. 09.494.01 Ø 16

H.1000 mm.
Art. 09.495.01 Ø 14
Art. 09.496.01 Ø 16

H.1200 mm.
Art. 09.497.01 Ø 14
Art. 09.498.01 Ø 16

H.1500 mm.
Art. 09.499.01 Ø 14
Art. 09.500.01 Ø 16

Fiamma grande / Big flame

Tondo / Round

H.950 mm.
Art. 09.500.20 Ø12

H.1000 mm.
Art. 09.500.23 Ø12

H.950 mm.
Art. 09.500.30 □ 12

H.1000 mm.
Art. 09.500.33 □ 12



Tondo / Round

H.950 mm.
Art. 09.501 Ø 14
Art. 09.502 Ø 16

H.1000 mm.
Art. 09.503 Ø 14
Art. 09.504 Ø 16

H.1200 mm.
Art. 09.505 Ø 14
Art. 09.506 Ø 16

H.1500 mm.
Art. 09.507 Ø 14
Art. 09.508 Ø 16



Tondo / Round

Borchia tornita / Turned stud
H.950 mm.
Art. 09.509 Ø 14
Art. 09.509.01 Ø 12

Borchia stampata / Stamped stud
H.950 mm.
Art. 09.509.02 Ø 14
Art. 09.509.03 Ø 12



Tondo / Round

Borchia tornita / Turned stud
H.950 mm.
Art. 09.510 Ø 14
Art. 09.510.07 Ø 12

Borchia stampata / Stamped stud
H.950 mm.
Art. 09.510.10 Ø 14
Art. 09.510.12 Ø 12



H.950 mm.

Art. 09.510.03 □ 14
Art. 09.510.05 □ 12



H.950 mm.

Art. 09.510.04 □ 14
Art. 09.510.06 □ 12



H.1500 mm.

Art. 09.510.08 □ 12
Art. 09.510.09 □ 14



Liscio / Smooth

H.950 mm
Art. 09.510.14 □ 12 mm
Borchia in acciaio fuso /
Cast steel stud

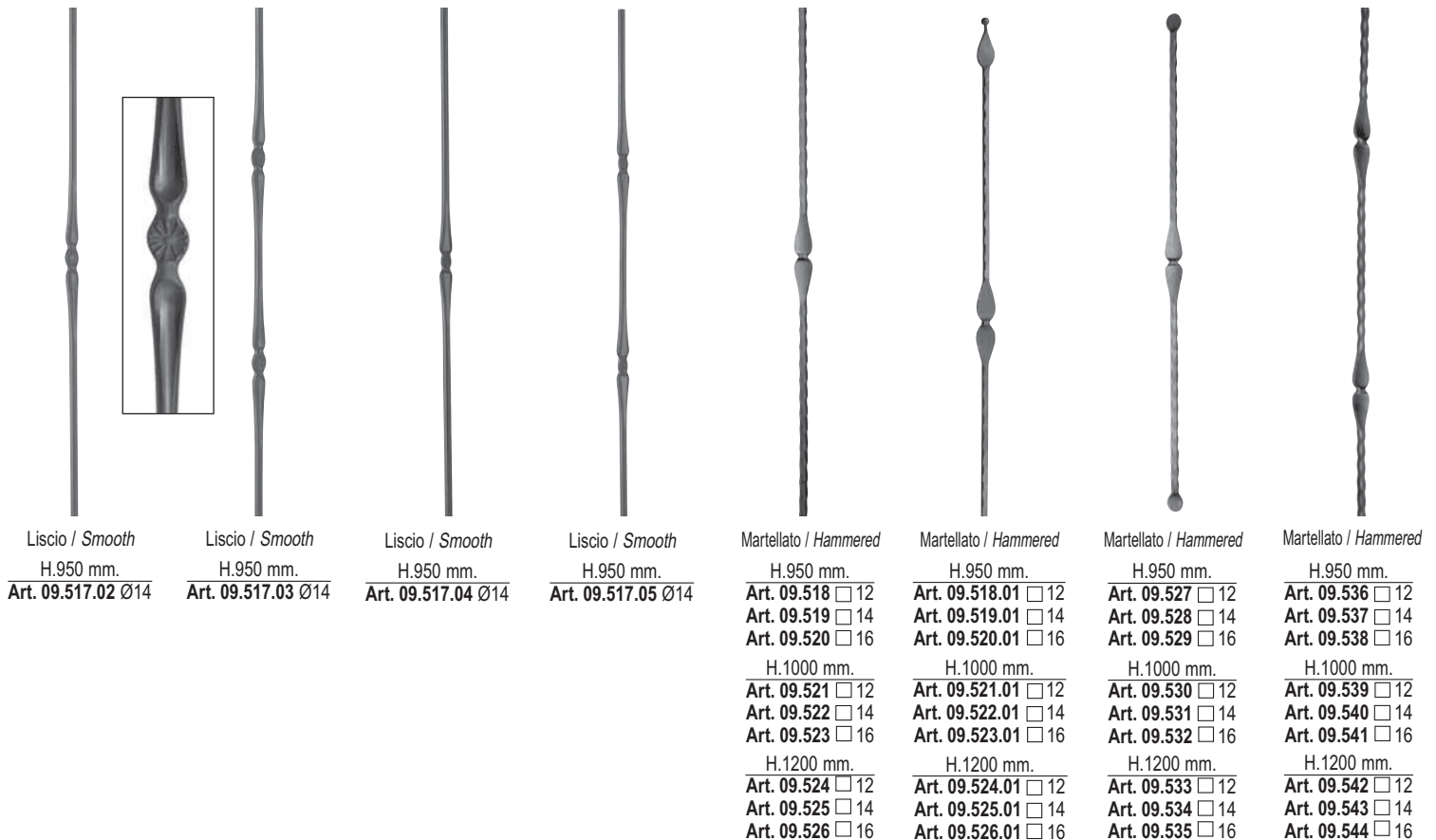
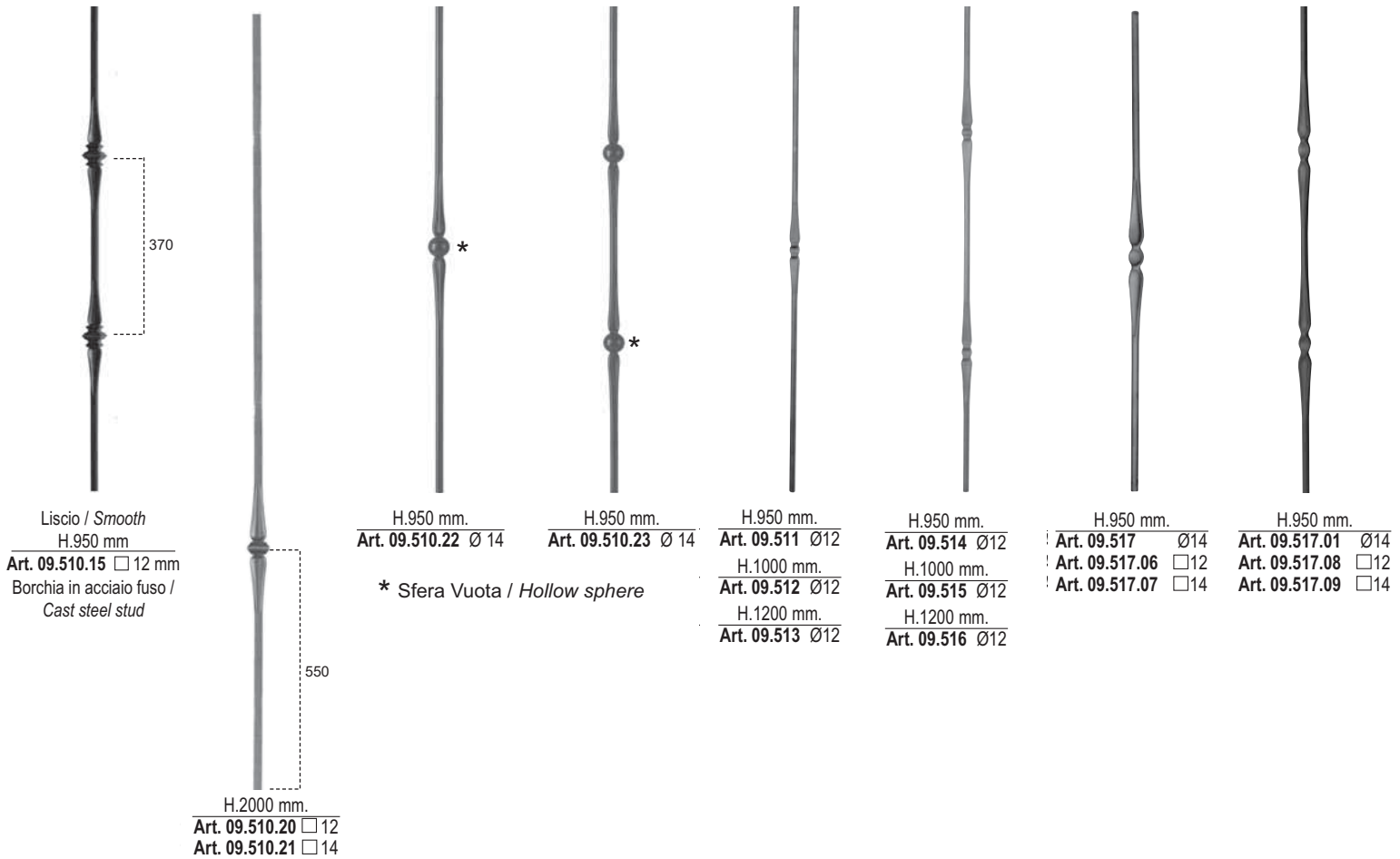



Martellato / Hammered
H.950 mm.
Art. 09.536.01 □ 12
Art. 09.537.01 □ 14
Art. 09.538.01 □ 16

Martellato / Hammered
H.950 mm.
Art. 09.545 □ 12
Art. 09.546 □ 14
Art. 09.547 □ 16

Martellato / Hammered
H.950 mm.
Art. 09.545.01 □ 12
Art. 09.546.01 □ 14
Art. 09.547.01 □ 16

Martellato / Hammered
H.950 mm.
Art. 09.554 □ 12
Art. 09.555 □ 14
Art. 09.556 □ 16

Martellato / Hammered
H.950 mm.
Art. 09.563 □ 12
Art. 09.564 □ 14
Art. 09.565 □ 16

Martellato / Hammered
H.950 mm.
Art. 09.572 □ 12
Art. 09.573 □ 14
Art. 09.574 □ 16

H.950 mm.
Art. 09.581 □ 12
Art. 09.582 □ 14
Art. 09.583 □ 16

H.1000 mm.
Art. 09.548 □ 12
Art. 09.549 □ 14
Art. 09.550 □ 16

H.1000 mm.
Art. 09.557 □ 12
Art. 09.558 □ 14
Art. 09.559 □ 16

H.1000 mm.
Art. 09.566 □ 12
Art. 09.567 □ 14
Art. 09.568 □ 16

H.1000 mm.
Art. 09.575 □ 12
Art. 09.576 □ 14
Art. 09.577 □ 16

H.1000 mm.
Art. 09.584 □ 12
Art. 09.585 □ 14
Art. 09.586 □ 16

H.1200 mm.
Art. 09.551 □ 12
Art. 09.552 □ 14
Art. 09.553 □ 16

H.1200 mm.
Art. 09.560 □ 12
Art. 09.561 □ 14
Art. 09.562 □ 16

H.1200 mm.
Art. 09.569 □ 12
Art. 09.570 □ 14
Art. 09.571 □ 16

H.1200 mm.
Art. 09.578 □ 12
Art. 09.579 □ 14
Art. 09.580 □ 16

H.1200 mm.
Art. 09.587 □ 12
Art. 09.588 □ 14
Art. 09.589 □ 16



H.950 mm.
Art. 09.608 □ 12
Art. 09.609 □ 14

H.950 mm.
Art. 09.614 □ 12
Art. 09.615 □ 14

H.950 mm.
Art. 09.620 □ 12
Art. 09.621 □ 14

H.950 mm.
Art. 09.625.01 □ 12
Art. 09.625.02 □ 14

H.950 mm.
Art. 09.625.03 □ 12
Art. 09.625.04 □ 14

Martellato / Hammered
H.950 mm
Art. 09.625.05 Ø 14 mm

Martellato / Hammered
H.950 mm
Art. 09.625.06 Ø 14 mm

H.1000 mm.
Art. 09.610 □ 12
Art. 09.611 □ 14

H.1000 mm.
Art. 09.616 □ 12
Art. 09.617 □ 14

H.1000 mm.
Art. 09.622 □ 12
Art. 09.623 □ 14

H.1200 mm.
Art. 09.612 □ 12
Art. 09.613 □ 14

H.1200 mm.
Art. 09.618 □ 12
Art. 09.619 □ 14

H.1200 mm.
Art. 09.624 □ 12
Art. 09.625 □ 14



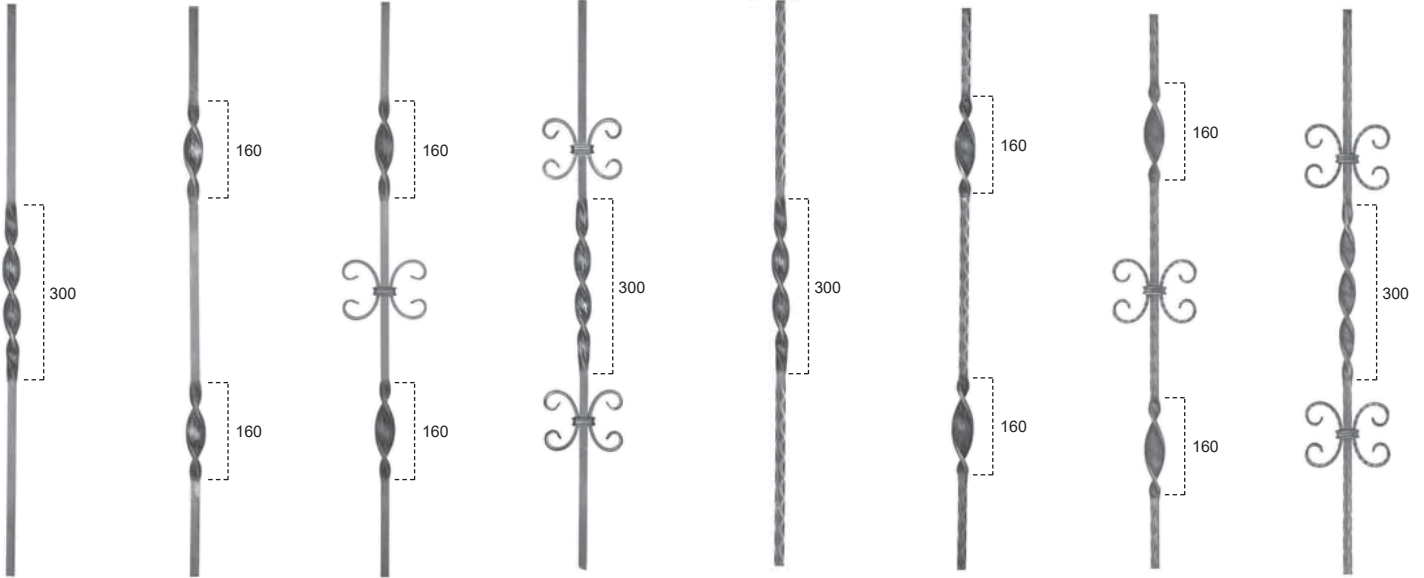

H.950 mm.
Art. 09.626 12
Art. 09.627 14

H.950 mm.
Art. 09.628 12
Art. 09.629 14

H.950 mm.
Art. 09.630
 12 \neq 12 X 6
Art. 09.630.01
 14 \neq 14 X 6

H.950 mm.
Art. 09.631
 12 \neq 12 X 6
Art. 09.631.01
 14 \neq 14 X 6

H.950 mm.
Art. 09.631.04 12
Art. 09.631.05 14

H.950 mm.
Art. 09.631.10 12
Art. 09.631.11 14

H.950 mm.
Art. 09.631.16
 12 \neq 12 X 6
Art. 09.631.17
 14 \neq 14 X 6

H.950 mm.
Art. 09.631.20
 12 \neq 12 X 6
Art. 09.631.21
 14 \neq 14 X 6

H.1200 mm.
Art. 09.627.01 12
Art. 09.627.02 14

H.1200 mm.
Art. 09.629.01 12
Art. 09.629.02 14

H.1200 mm.
Art. 09.630.02
 12 \neq 12 X 6
Art. 09.630.03
 14 \neq 14 X 6

H.1200 mm.
Art. 09.631.02
 12 \neq 12 X 6
Art. 09.631.03
 14 \neq 14 X 6

H.1200 mm.
Art. 09.631.06 12
Art. 09.631.07 14

H.1200 mm.
Art. 09.631.12 12
Art. 09.631.13 14

H.1200 mm.
Art. 09.631.18
 12 \neq 12 X 6
Art. 09.631.19
 14 \neq 14 X 6

H.1200 mm.
Art. 09.631.22
 12 \neq 12 X 6
Art. 09.631.23
 14 \neq 14 X 6

H.1500 mm.
Art. 09.627.03 12
Art. 09.627.04 14

H.1500 mm.
Art. 09.629.03 12
Art. 09.629.04 14

H.1500 mm.
Art. 09.631.08 12
Art. 09.631.09 14

H.1500 mm.
Art. 09.631.14 12
Art. 09.631.15 14

H.1500 mm.
Art. 09.631.14 12
Art. 09.631.15 14

H.1500 mm.
Art. 09.631.18
 12 \neq 12 X 6
Art. 09.631.19
 14 \neq 14 X 6

H.1500 mm.
Art. 09.631.22
 12 \neq 12 X 6
Art. 09.631.23
 14 \neq 14 X 6



Martellato/Hammered

H.950 mm.
Art. 09.632 12
Art. 09.632.01 14
Art. 09.632.02 16

H.1200 mm.
Art. 09.632.03 12
Art. 09.632.04 14
Art. 09.632.05 16

H.1500 mm.
Art. 09.632.06 12
Art. 09.632.07 14
Art. 09.632.08 16

H.1800 mm.
Art. 09.632.09 12
Art. 09.632.10 14
Art. 09.632.11 16

Martellato/Hammered

H.950 mm.
Art. 09.633 12
Art. 09.633.01 14
Art. 09.633.02 16

H.1200 mm.
Art. 09.633.03 12
Art. 09.633.04 14
Art. 09.633.05 16

H.1500 mm.
Art. 09.633.06 12
Art. 09.633.07 14
Art. 09.633.08 16

H.1800 mm.
Art. 09.633.09 12
Art. 09.633.10 14
Art. 09.633.11 16

H.950 mm.
Art. 09.633.12 12
Art. 09.633.13 14
Art. 09.633.14 16

H.1200 mm.
Art. 09.633.15 12
Art. 09.633.16 14
Art. 09.633.17 16

H.1500 mm.
Art. 09.633.18 12
Art. 09.633.19 14
Art. 09.633.20 16

H.1800 mm.
Art. 09.633.21 12
Art. 09.633.22 14
Art. 09.633.23 16

H.950 mm.
Art. 09.633.24 12
Art. 09.633.25 14
Art. 09.633.26 16

H.1200 mm.
Art. 09.633.27 12
Art. 09.633.28 14
Art. 09.633.29 16

H.1500 mm.
Art. 09.633.30 12
Art. 09.633.31 14
Art. 09.633.32 16

H.1800 mm.
Art. 09.633.33 12
Art. 09.633.34 14
Art. 09.633.35 16

Martellato/Hammered

H.1000 X L.140 mm.
Art. 09.634 12
Art. 09.635 14

Martellato/Hammered

H.1000 X L.140 mm.
Art. 09.636 12
Art. 09.637 14



Martellato/Hammered
H.1000 X L.140 mm.
Art. 09.638 12
Art. 09.639 14



Martellato/Hammered
H.950 mm.
Art. 09.640 12
Art. 09.641 14
Art. 09.642 16
H.1000 mm.
Art. 09.643 12
Art. 09.644 14
Art. 09.645 16
H.1200 mm.
Art. 09.646 12
Art. 09.647 14
Art. 09.648 16

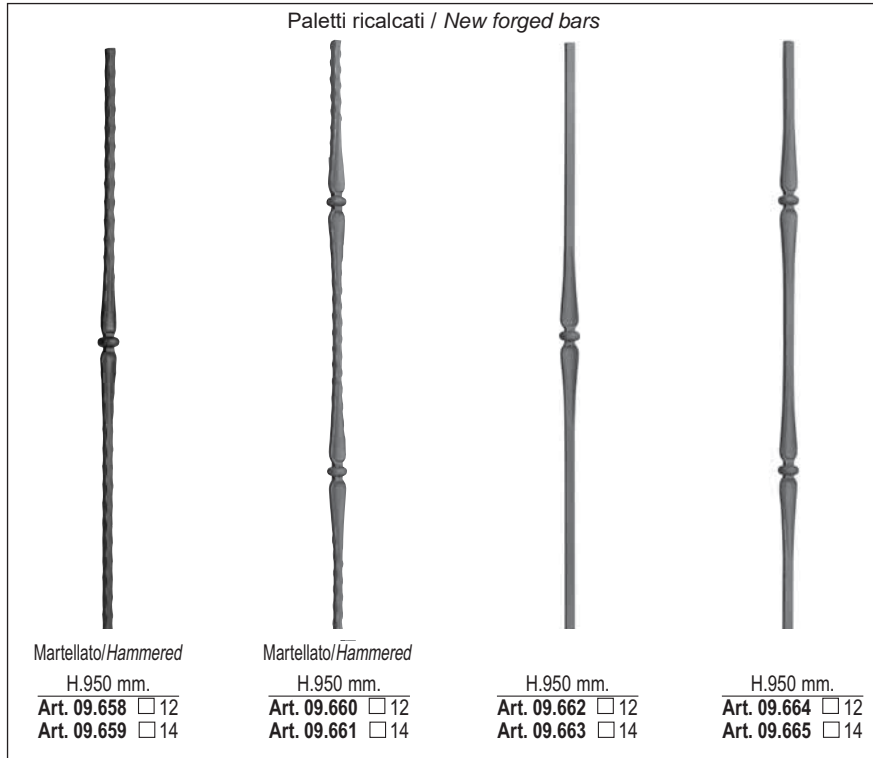

H.950 X L.200mm.
Art. 09.666 14



H.950 X L.200mm.
Art. 09.667 14



Martellato. / Hammered
H. 950 X L. 130 mm.
Art. 09.668 12
Art. 09.669 14
Art. 09.669.01 16
H. 1200 X L. 130 mm.
Art. 09.669.02 12
Art. 09.669.03 14
Art. 09.669.04 16
H. 1500 X L. 130 mm.
Art. 09.669.05 12
Art. 09.669.06 14
Art. 09.669.07 16
H. 1800 X L. 130 mm.
Art. 09.669.08 12
Art. 09.669.09 14
Art. 09.669.10 16



H. 950 X L. 130 mm.
Art. 09.671.01 14



H.950 mm.
Art. 09.672 12
Art. 09.673 14
Art. 09.674 16



H.950 mm.
Art. 09.684 12
Art. 09.685 14
Art. 09.686 16



H.950 mm.
Art. 09.696 12
Art. 09.697 14
Art. 09.698 16



H.950 mm.
Art. 09.708 12
Art. 09.709 14
Art. 09.710 16
H.1200 mm.
Art. 09.711 12
Art. 09.712 14
Art. 09.713 16



Martel. / Hammered
H.950 mm.
Art. 09.720 12
Art. 09.721 14
Art. 09.722 16
H.1200 mm.
Art. 09.723 12
Art. 09.724 14
Art. 09.725 16
H.1500 mm.
Art. 09.726 12
Art. 09.727 14
Art. 09.728 16
H.1800 mm.
Art. 09.729 12
Art. 09.730 14
Art. 09.731 16

Palline piccole / Small Balls

H.950 mm. Art. 09.732 Ø 14 Art. 09.733 Ø 16	H.950 mm. Art. 09.740 □12 Art. 09.741 □14 Art. 09.742 □16	H.950 mm. Art. 09.752 □12 Art. 09.753 □14 Art. 09.754 □16	H.950 mm. Art. 09.764 □12 Art. 09.765 □14 Art. 09.766 □16	H.950 mm. Art. 09.776 □12 Art. 09.777 □14 Art. 09.778 □16	H.950 mm. Art. 09.788 □12 Art. 09.789 □14 Art. 09.790 □16	H.950 mm. Art. 09.800 □12 Art. 09.801 □14 Art. 09.802 □16	H.950 mm. Art. 09.812 □12 Art. 09.813 □14 Art. 09.814 □16
H.1200 mm. Art. 09.734 Ø 14 Art. 09.735 Ø 16	H.1000 mm. Art. 09.743 □12 Art. 09.744 □14 Art. 09.745 □16	H.1000 mm. Art. 09.755 □12 Art. 09.756 □14 Art. 09.757 □16	H.1000 mm. Art. 09.767 □12 Art. 09.768 □14 Art. 09.769 □16	H.1000 mm. Art. 09.779 □12 Art. 09.780 □14 Art. 09.781 □16	H.1000 mm. Art. 09.791 □12 Art. 09.792 □14 Art. 09.793 □16	H.1000 mm. Art. 09.803 □12 Art. 09.804 □14 Art. 09.805 □16	H.1000 mm. Art. 09.815 □12 Art. 09.816 □14 Art. 09.817 □16
H.1500 mm. Art. 09.736 Ø 14 Art. 09.737 Ø 16	H.1200 mm. Art. 09.746 □12 Art. 09.747 □14 Art. 09.748 □16	H.1200 mm. Art. 09.758 □12 Art. 09.759 □14 Art. 09.760 □16	H.1200 mm. Art. 09.770 □12 Art. 09.771 □14 Art. 09.772 □16	H.1200 mm. Art. 09.782 □12 Art. 09.783 □14 Art. 09.784 □16	H.1200 mm. Art. 09.794 □12 Art. 09.795 □14 Art. 09.796 □16	H.1200 mm. Art. 09.806 □12 Art. 09.807 □14 Art. 09.808 □16	H.1200 mm. Art. 09.818 □12 Art. 09.819 □14 Art. 09.820 □16
H.1800 mm. Art. 09.738 Ø 14 Art. 09.739 Ø 16	H.1500 mm. Art. 09.749 □12 Art. 09.750 □14 Art. 09.751 □16	H.1500 mm. Art. 09.761 □12 Art. 09.762 □14 Art. 09.763 □16	H.1500 mm. Art. 09.773 □12 Art. 09.774 □14 Art. 09.775 □16	H.1500 mm. Art. 09.785 □12 Art. 09.786 □14 Art. 09.787 □16	H.1500 mm. Art. 09.797 □12 Art. 09.798 □14 Art. 09.799 □16	H.1500 mm. Art. 09.809 □12 Art. 09.810 □14 Art. 09.811 □16	H.1500 mm. Art. 09.821 □12 Art. 09.822 □14 Art. 09.823 □16
H.950 mm. Art. 09.824 □12 Art. 09.825 □14 Art. 09.826 □16	H.950 mm. Art. 09.836 □12 Art. 09.837 □14 Art. 09.838 □16	H.950 mm. Art. 09.848 □12 Art. 09.849 □14 Art. 09.850 □16	H. 950 X L. 130 mm. Art. 09.860 □12 Art. 09.861 □14 Art. 09.862 □16	H. 950 X L. 130 mm. Art. 09.875 □12 Art. 09.876 □14 Art. 09.877 □16	Martellato Hammered H.950 mm. Art. 09.890 □12 Art. 09.891 □14 Art. 09.892 □16	Martellato Hammered H.950 mm. Art. 09.902 □12 Art. 09.903 □14 Art. 09.904 □16	Martellato Hammered H.950 mm. Art. 09.914 □12 Art. 09.915 □14 Art. 09.916 □16
H.1000 mm. Art. 09.827 □12 Art. 09.828 □14 Art. 09.829 □16	H.1000 mm. Art. 09.839 □12 Art. 09.840 □14 Art. 09.841 □16	H.1000 mm. Art. 09.851 □12 Art. 09.852 □14 Art. 09.853 □16	H. 1000 X L. 130 mm. Art. 09.863 □12 Art. 09.864 □14 Art. 09.865 □16	H. 1000 X L. 130 mm. Art. 09.878 □12 Art. 09.879 □14 Art. 09.880 □16	H.1000 mm. Art. 09.893 □12 Art. 09.894 □14 Art. 09.895 □16	H.1000 mm. Art. 09.905 □12 Art. 09.906 □14 Art. 09.907 □16	H.1000 mm. Art. 09.917 □12 Art. 09.918 □14 Art. 09.919 □16
H.1200 mm. Art. 09.830 □12 Art. 09.831 □14 Art. 09.832 □16	H.1200 mm. Art. 09.842 □12 Art. 09.843 □14 Art. 09.844 □16	H.1200 mm. Art. 09.855 □14 Art. 09.856 □16	H. 1200 X L. 130 mm. Art. 09.866 □12 Art. 09.867 □14 Art. 09.868 □16	H. 1200 X L. 130 mm. Art. 09.881 □12 Art. 09.882 □14 Art. 09.883 □16	H.1200 mm. Art. 09.896 □12 Art. 09.897 □14 Art. 09.898 □16	H.1200 mm. Art. 09.908 □12 Art. 09.909 □14 Art. 09.910 □16	H.1200 mm. Art. 09.920 □12 Art. 09.921 □14 Art. 09.922 □16
H.1500 mm. Art. 09.833 □12 Art. 09.834 □14 Art. 09.835 □16	H.1500 mm. Art. 09.845 □12 Art. 09.846 □14 Art. 09.847 □16	H.1500 mm. Art. 09.857 □12 Art. 09.858 □14 Art. 09.859 □16	H. 1500 X L. 130 mm. Art. 09.869 □12 Art. 09.870 □14 Art. 09.871 □16	H. 1500 X L. 130 mm. Art. 09.884 □12 Art. 09.885 □14 Art. 09.886 □16	H.1500 mm. Art. 09.899 □12 Art. 09.900 □14 Art. 09.901 □16	H.1500 mm. Art. 09.911 □12 Art. 09.912 □14 Art. 09.913 □16	H.1500 mm. Art. 09.923 □12 Art. 09.924 □14 Art. 09.925 □16
			H. 1800 X L. 130 mm. Art. 09.872 □12 Art. 09.873 □14 Art. 09.874 □16	H. 1800 X L. 130 mm. Art. 09.887 □12 Art. 09.888 □14 Art. 09.889 □16			



- | | | | | | | | | | | | | | | | |
|---|-----------------------------|---|-----------------------------|---|-----------------------------|---|-----------------------------|---|-----------------------------|---|-----------------------------|---|-----------------------------|---|-----------------------------|
| Martellato Hammered
H.950 mm. | | Martellato Hammered
H.950 mm. | | Martellato Hammered
H.950 mm. | | Martellato Hammered
H.950 mm. | | Martellato Hammered
H.950 mm. | | Martellato Hammered
H.950 mm. | | Martellato Hammered
H.950 mm. | | Martellato Hammered
H.950 mm. | |
| Art. 09.926 | <input type="checkbox"/> 12 | Art. 09.938 | <input type="checkbox"/> 12 | Art. 09.950 | <input type="checkbox"/> 12 | Art. 09.962 | <input type="checkbox"/> 12 | Art. 09.974 | <input type="checkbox"/> 12 | Art. 09.986 | <input type="checkbox"/> 12 | Art. 09.998 | <input type="checkbox"/> 12 | Art. 09.999.11 | <input type="checkbox"/> 12 |
| Art. 09.927 | <input type="checkbox"/> 14 | Art. 09.939 | <input type="checkbox"/> 14 | Art. 09.951 | <input type="checkbox"/> 14 | Art. 09.963 | <input type="checkbox"/> 14 | Art. 09.975 | <input type="checkbox"/> 14 | Art. 09.987 | <input type="checkbox"/> 14 | Art. 09.999 | <input type="checkbox"/> 14 | Art. 09.999.12 | <input type="checkbox"/> 14 |
| Art. 09.928 | <input type="checkbox"/> 16 | Art. 09.940 | <input type="checkbox"/> 16 | Art. 09.952 | <input type="checkbox"/> 16 | Art. 09.964 | <input type="checkbox"/> 16 | Art. 09.976 | <input type="checkbox"/> 16 | Art. 09.988 | <input type="checkbox"/> 16 | Art. 09.999.01 | <input type="checkbox"/> 16 | Art. 09.999.13 | <input type="checkbox"/> 16 |
| H.1000 mm. | | H.1000 mm. | | H.1000 mm. | | H.1000 mm. | | H.1000 mm. | | H.1000 mm. | | H.1000 mm. | | H.1000 mm. | |
| Art. 09.929 | <input type="checkbox"/> 12 | Art. 09.941 | <input type="checkbox"/> 12 | Art. 09.953 | <input type="checkbox"/> 12 | Art. 09.965 | <input type="checkbox"/> 12 | Art. 09.977 | <input type="checkbox"/> 12 | Art. 09.989 | <input type="checkbox"/> 12 | Art. 09.999.02 | <input type="checkbox"/> 12 | Art. 09.999.14 | <input type="checkbox"/> 12 |
| Art. 09.930 | <input type="checkbox"/> 14 | Art. 09.942 | <input type="checkbox"/> 14 | Art. 09.954 | <input type="checkbox"/> 14 | Art. 09.966 | <input type="checkbox"/> 14 | Art. 09.978 | <input type="checkbox"/> 14 | Art. 09.990 | <input type="checkbox"/> 14 | Art. 09.999.03 | <input type="checkbox"/> 14 | Art. 09.999.15 | <input type="checkbox"/> 14 |
| Art. 09.931 | <input type="checkbox"/> 16 | Art. 09.943 | <input type="checkbox"/> 16 | Art. 09.955 | <input type="checkbox"/> 16 | Art. 09.967 | <input type="checkbox"/> 16 | Art. 09.979 | <input type="checkbox"/> 16 | Art. 09.991 | <input type="checkbox"/> 16 | Art. 09.999.04 | <input type="checkbox"/> 16 | Art. 09.999.16 | <input type="checkbox"/> 16 |
| H.1200 mm. | | H.1200 mm. | | H.1200 mm. | | H.1200 mm. | | H.1200 mm. | | H.1200 mm. | | H.1200 mm. | | H.1200 mm. | |
| Art. 09.932 | <input type="checkbox"/> 12 | Art. 09.944 | <input type="checkbox"/> 12 | Art. 09.956 | <input type="checkbox"/> 12 | Art. 09.968 | <input type="checkbox"/> 12 | Art. 09.980 | <input type="checkbox"/> 12 | Art. 09.992 | <input type="checkbox"/> 12 | Art. 09.999.05 | <input type="checkbox"/> 12 | Art. 09.999.17 | <input type="checkbox"/> 12 |
| Art. 09.933 | <input type="checkbox"/> 14 | Art. 09.945 | <input type="checkbox"/> 14 | Art. 09.957 | <input type="checkbox"/> 14 | Art. 09.969 | <input type="checkbox"/> 14 | Art. 09.981 | <input type="checkbox"/> 14 | Art. 09.993 | <input type="checkbox"/> 14 | Art. 09.999.06 | <input type="checkbox"/> 14 | Art. 09.999.18 | <input type="checkbox"/> 14 |
| Art. 09.934 | <input type="checkbox"/> 16 | Art. 09.946 | <input type="checkbox"/> 16 | Art. 09.958 | <input type="checkbox"/> 16 | Art. 09.970 | <input type="checkbox"/> 16 | Art. 09.982 | <input type="checkbox"/> 16 | Art. 09.994 | <input type="checkbox"/> 16 | Art. 09.999.07 | <input type="checkbox"/> 16 | Art. 09.999.19 | <input type="checkbox"/> 16 |
| H.1500 mm. | | H.1500 mm. | | H.1500 mm. | | H.1500 mm. | | H.1500 mm. | | H.1500 mm. | | H.1500 mm. | | H.1500 mm. | |
| Art. 09.935 | <input type="checkbox"/> 12 | Art. 09.947 | <input type="checkbox"/> 12 | Art. 09.959 | <input type="checkbox"/> 12 | Art. 09.971 | <input type="checkbox"/> 12 | Art. 09.983 | <input type="checkbox"/> 12 | Art. 09.995 | <input type="checkbox"/> 12 | Art. 09.999.08 | <input type="checkbox"/> 12 | Art. 09.999.20 | <input type="checkbox"/> 12 |
| Art. 09.936 | <input type="checkbox"/> 14 | Art. 09.948 | <input type="checkbox"/> 14 | Art. 09.960 | <input type="checkbox"/> 14 | Art. 09.972 | <input type="checkbox"/> 14 | Art. 09.984 | <input type="checkbox"/> 14 | Art. 09.996 | <input type="checkbox"/> 14 | Art. 09.999.09 | <input type="checkbox"/> 14 | Art. 09.999.21 | <input type="checkbox"/> 14 |
| Art. 09.937 | <input type="checkbox"/> 16 | Art. 09.949 | <input type="checkbox"/> 16 | Art. 09.961 | <input type="checkbox"/> 16 | Art. 09.973 | <input type="checkbox"/> 16 | Art. 09.985 | <input type="checkbox"/> 16 | Art. 09.997 | <input type="checkbox"/> 16 | Art. 09.999.10 | <input type="checkbox"/> 16 | Art. 09.999.22 | <input type="checkbox"/> 16 |
| H.1800 mm. | | H.1800 mm. | | H.1800 mm. | | H.1800 mm. | | H.1800 mm. | | H.1800 mm. | | H.1800 mm. | | H.1800 mm. | |
| Art. 09.999.23 | | <input type="checkbox"/> 12 | | Art. 09.999.23 | | <input type="checkbox"/> 12 | | Art. 09.999.23 | | <input type="checkbox"/> 12 | | Art. 09.999.23 | | <input type="checkbox"/> 12 | |
| Art. 09.999.24 | | <input type="checkbox"/> 14 | | Art. 09.999.24 | | <input type="checkbox"/> 14 | | Art. 09.999.24 | | <input type="checkbox"/> 14 | | Art. 09.999.24 | | <input type="checkbox"/> 14 | |
| Art. 09.999.25 | | <input type="checkbox"/> 16 | | Art. 09.999.25 | | <input type="checkbox"/> 16 | | Art. 09.999.25 | | <input type="checkbox"/> 16 | | Art. 09.999.25 | | <input type="checkbox"/> 16 | |

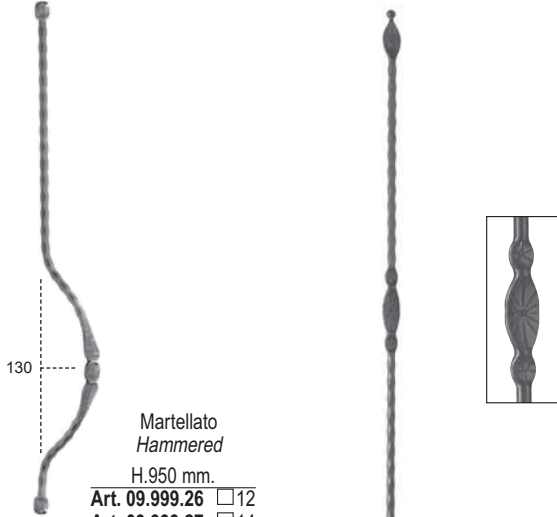

- | | | | | | |
|---|-----------------------------|---|-----------------------------|-------------------------------------|------|
| Martellato Hammered
H.950 mm. | | Martellato/Hammered
H.950 mm. | | Liscio / Smooth
H.950 mm. | |
| Art. 09.999.26 | <input type="checkbox"/> 12 | Art. 09.1002.01 | <input type="checkbox"/> 12 | Art. 09.1003 | Ø 14 |
| Art. 09.999.27 | <input type="checkbox"/> 14 | Art. 09.1002.02 | <input type="checkbox"/> 14 | Art. 09.1003.01 | Ø 16 |
| Art. 09.999.28 | <input type="checkbox"/> 16 | Art. 09.1002.03 | <input type="checkbox"/> 16 | | |
| H.1000 mm. | | H.1000 mm. | | H.1000 mm. | |
| Art. 09.999.29 | <input type="checkbox"/> 12 | Art. 09.1002.04 | <input type="checkbox"/> 12 | Art. 09.1003.02 | Ø 14 |
| Art. 09.999.30 | <input type="checkbox"/> 14 | Art. 09.1002.05 | <input type="checkbox"/> 14 | Art. 09.1003.03 | Ø 16 |
| Art. 09.999.31 | <input type="checkbox"/> 16 | Art. 09.1002.06 | <input type="checkbox"/> 16 | | |
| H.1200 mm. | | H.1200 mm. | | H.1200 mm. | |
| Art. 09.999.32 | <input type="checkbox"/> 12 | Art. 09.1002.07 | <input type="checkbox"/> 12 | Art. 09.1003.04 | Ø 14 |
| Art. 09.999.33 | <input type="checkbox"/> 14 | Art. 09.1002.08 | <input type="checkbox"/> 14 | Art. 09.1003.05 | Ø 16 |
| Art. 09.999.34 | <input type="checkbox"/> 16 | Art. 09.1002.09 | <input type="checkbox"/> 16 | | |
| H.1500 mm. | | H.1500 mm. | | H.1500 mm. | |
| Art. 09.999.35 | <input type="checkbox"/> 12 | Art. 09.1002.10 | <input type="checkbox"/> 12 | Art. 09.1003.06 | Ø 14 |
| Art. 09.999.36 | <input type="checkbox"/> 14 | Art. 09.1002.11 | <input type="checkbox"/> 14 | Art. 09.1003.07 | Ø 16 |
| Art. 09.999.37 | <input type="checkbox"/> 16 | Art. 09.1002.12 | <input type="checkbox"/> 16 | | |
| H.1800 mm. | | H.1800 mm. | | H.1800 mm. | |
| Art. 09.999.38 | <input type="checkbox"/> 12 | | | | |
| Art. 09.999.39 | <input type="checkbox"/> 14 | | | | |
| Art. 09.999.40 | <input type="checkbox"/> 16 | | | | |



Tutte le parti di questo catalogo - foto comprese - sono di proprietà Euro-Fer. La riproduzione, anche parziale, è vietata in ogni forma e con ogni mezzo. / Every part of this catalogue - photos included - is Euro-Fer's property. All forms of copying are strictly prohibited.



Liscio / Smooth
H.950 mm.

- Art. 09.1004 12
- Art. 09.1004.01 14
- Art. 09.1004.02 16

H.1000 mm.

- Art. 09.1004.03 12
- Art. 09.1004.04 14
- Art. 09.1004.05 16

H.1200 mm.

- Art. 09.1004.06 12
- Art. 09.1004.07 14
- Art. 09.1004.08 16

H.1500 mm.

- Art. 09.1004.09 12
- Art. 09.1004.10 14
- Art. 09.1004.11 16



Liscio / Smooth
H.950 mm.

- Art. 09.1005 12
- Art. 09.1005.01 14
- Art. 09.1005.02 16

H.1000 mm.

- Art. 09.1005.03 12
- Art. 09.1005.04 14
- Art. 09.1005.05 16

H.1200 mm.

- Art. 09.1005.06 12
- Art. 09.1005.07 14
- Art. 09.1005.08 16

H.1500 mm.

- Art. 09.1005.09 12
- Art. 09.1005.10 14
- Art. 09.1005.11 16



Martellato/Hammered
H.950 mm.

- Art. 09.1006 12
- Art. 09.1006.01 14
- Art. 09.1006.02 16

H.1000 mm.

- Art. 09.1006.03 12
- Art. 09.1006.04 14
- Art. 09.1006.05 16

H.1200 mm.

- Art. 09.1006.06 12
- Art. 09.1006.07 14
- Art. 09.1006.08 16

H.1500 mm.

- Art. 09.1006.09 12
- Art. 09.1006.10 14
- Art. 09.1006.11 16



Liscio / Smooth
H.950 mm.

- Art. 09.1007 Ø 12
- Art. 09.1007.01 Ø 14

H.1000 mm.

- Art. 09.1007.02 Ø 12
- Art. 09.1007.03 Ø 14

H.1200 mm.

- Art. 09.1007.04 Ø 12
- Art. 09.1007.05 Ø 14

H.1500 mm.

- Art. 09.1007.06 Ø 12
- Art. 09.1007.07 Ø 14



Liscio / Smooth
H.950 mm.

- Art. 09.1008 12



Liscio / Smooth
H.950 mm.

- Art. 09.1009 12



Martellato / Hammered
H.950 mm.

- Art. 09.1010 12

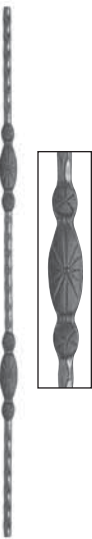

Martellato / Hammered
H.950 mm.

- Art. 09.1011 12

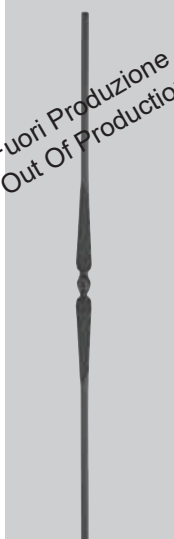

Fuori Produzione
Out Of Production

Liscio / Smooth
H.950 mm.

- Art. 09.1012 12



100
o / or
150

Liscio / Smooth
H.950 X L.100 mm.

- Art. 09.1013 Ø 12
- Art. 09.1013.01 Ø 14
- H.950 X L.150 mm.
- Art. 09.1013.02 Ø 12
- Art. 09.1013.03 Ø 14



100
o / or
150

Martellato / Hammered
H.950 X L.100 mm.

- Art. 09.1014 14
- H.950 X L.150 mm.
- Art. 09.1014.01 14



100
o / or
150

Liscio / Smooth
H.950 X L.100 mm.

- Art. 09.1015 14
- H.950 X L.150 mm.
- Art. 09.1015.01 14

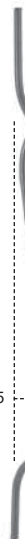

125

Liscio / Smooth
H.950 X L.125 mm.

- Art. 09.1016 Ø 14



220

Liscio / Smooth
H.1200 mm.

- Art. 09.1017 Ø 25

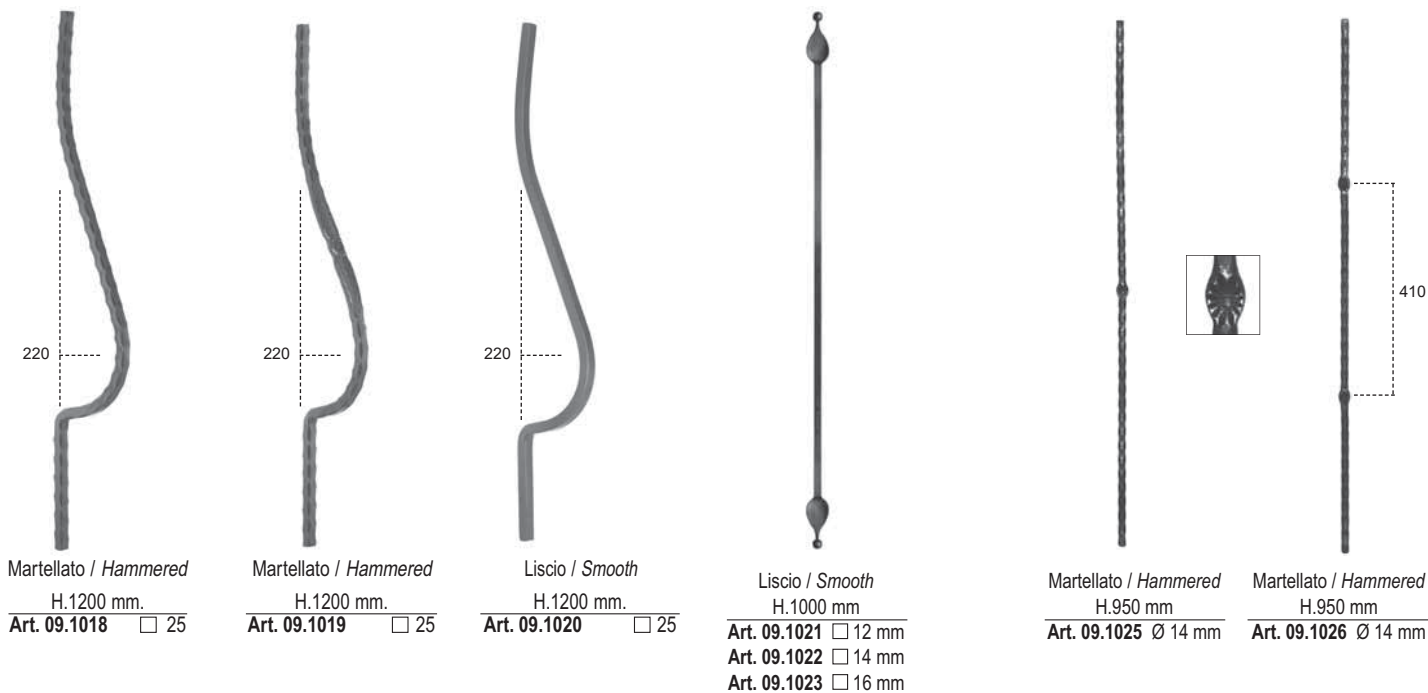

Martellato / Hammered
H.1200 mm.
Art. 09.1018 25

Martellato / Hammered
H.1200 mm.
Art. 09.1019 25

Liscio / Smooth
H.1200 mm.
Art. 09.1020 25

Liscio / Smooth
H.1000 mm
Art. 09.1021 12 mm
Art. 09.1022 14 mm
Art. 09.1023 16 mm

Martellato / Hammered
H.950 mm
Art. 09.1025 Ø 14 mm

Martellato / Hammered
H.950 mm
Art. 09.1026 Ø 14 mm



Schiacciata sullo spigolo /
Ornament on the edge
Liscio / Smooth

H 950 mm
Art. 09.1050 12x12 mm
Art. 09.1051 14x14 mm
Art. 09.1052 16x16 mm

H 1000 mm
Art. 09.1053 12x12 mm
Art. 09.1054 14x14 mm
Art. 09.1055 16x16 mm

H 1200 mm
Art. 09.1056 12x12 mm
Art. 09.1057 14x14 mm
Art. 09.1058 16x16 mm

Schiacciata sullo spigolo /
Ornament on the edge
Liscio / Smooth

H 950 mm
Art. 09.1059 12x12 mm
Art. 09.1060 14x14 mm
Art. 09.1061 16x16 mm

H 1000 mm
Art. 09.1062 12x12 mm
Art. 09.1063 14x14 mm
Art. 09.1064 16x16 mm

H 1200 mm
Art. 09.1065 12x12 mm
Art. 09.1066 14x14 mm
Art. 09.1067 16x16 mm

Schiacciata sullo spigolo /
Ornament on the edge
Martellato / Hammered

H 950 mm
Art. 09.1068 12x12 mm
Art. 09.1069 14x14 mm
Art. 09.1070 16x16 mm

H 1000 mm
Art. 09.1071 12x12 mm
Art. 09.1072 14x14 mm
Art. 09.1073 16x16 mm

H 1200 mm
Art. 09.1074 12x12 mm
Art. 09.1075 14x14 mm
Art. 09.1076 16x16 mm

Schiacciata sullo spigolo /
Ornament on the edge
Martellato / Hammered

H 950 mm
Art. 09.1077 12x12 mm
Art. 09.1078 14x14 mm
Art. 09.1079 16x16 mm

H 1000 mm
Art. 09.1080 12x12 mm
Art. 09.1081 14x14 mm
Art. 09.1082 16x16 mm

H 1200 mm
Art. 09.1083 12x12 mm
Art. 09.1084 14x14 mm
Art. 09.1085 16x16 mm



ELEMENTI IN FERRO RICALCATO
NEW FORGED BARS

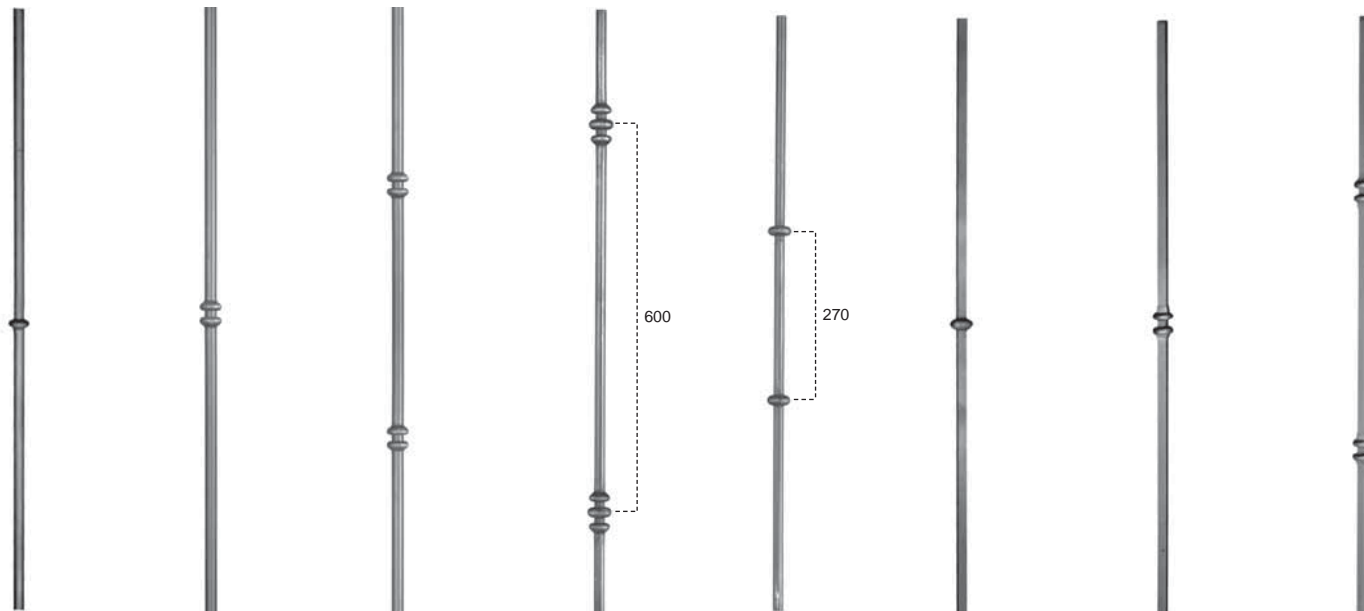

Tondo / Round		Tondo / Round		Tondo / Round		Tondo / Round		Tondo / Round		Tondo / Round		Tondo / Round		Tondo / Round	
H.950 mm.		H.950 mm.		H.950 mm.		H.1500 mm.		H.950 mm.		H.950 mm.		H.950 mm.		H.950 mm.	
Art. 10.001	Ø 16	Art. 10.005	Ø 16	Art. 10.009	Ø 16	Art. 10.012.03	Ø 12	Art. 10.012.09	Ø 12	Art. 10.013	□ 14	Art. 10.017	□ 14	Art. 10.021	□ 14
Art. 10.001.01	Ø 14	Art. 10.005.01	Ø 14	Art. 10.009.01	Ø 14	Art. 10.012.04	Ø 14	Art. 10.012.10	Ø 14	Art. 10.013.01	□ 16	Art. 10.017.01	□ 16	Art. 10.021.01	□ 16
Art. 10.001.02	Ø 12	Art. 10.005.02	Ø 12	Art. 10.009.02	Ø 12	Art. 10.012.05	Ø 16	Art. 10.012.11	Ø 16	Art. 10.013.02	□ 12	Art. 10.017.02	□ 12	Art. 10.021.02	□ 12
H.1000 mm.		H.1000 mm.		H.1000 mm.		H.1800 mm.		H.950 mm.		H.1000 mm.		H.1000 mm.		H.1000 mm.	
Art. 10.002	Ø 16	Art. 10.006	Ø 16	Art. 10.010	Ø 16	Art. 10.012.06	Ø 12	Art. 10.014	□ 14	Art. 10.014	□ 14	Art. 10.018	□ 14	Art. 10.022	□ 14
Art. 10.002.01	Ø 14	Art. 10.006.01	Ø 14	Art. 10.010.01	Ø 14	Art. 10.012.07	Ø 14	Art. 10.014.01	□ 16	Art. 10.014.01	□ 16	Art. 10.018.01	□ 16	Art. 10.022.01	□ 16
Art. 10.002.02	Ø 12	Art. 10.006.02	Ø 12	Art. 10.010.02	Ø 12	Art. 10.012.08	Ø 16	Art. 10.014.02	□ 12	Art. 10.014.02	□ 12	Art. 10.018.02	□ 12	Art. 10.022.02	□ 12
H.1200 mm.		H.1200 mm.		H.1200 mm.				H.1200 mm.		H.1200 mm.		H.1200 mm.		H.1200 mm.	
Art. 10.003	Ø 16	Art. 10.007	Ø 16	Art. 10.011	Ø 16			Art. 10.015	□ 14	Art. 10.015	□ 14	Art. 10.019	□ 14	Art. 10.023	□ 14
Art. 10.003.01	Ø 14	Art. 10.007.01	Ø 14	Art. 10.011.01	Ø 14			Art. 10.015.01	□ 16	Art. 10.015.01	□ 16	Art. 10.019.01	□ 16	Art. 10.023.01	□ 16
Art. 10.003.02	Ø 12	Art. 10.007.02	Ø 12	Art. 10.011.02	Ø 12			Art. 10.015.02	□ 12	Art. 10.015.02	□ 12	Art. 10.019.02	□ 12	Art. 10.023.02	□ 12
H.1500 mm.		H.1500 mm.		H.1500 mm.				H.1500 mm.		H.1500 mm.		H.1500 mm.		H.1500 mm.	
Art. 10.004	Ø 16	Art. 10.008	Ø 16	Art. 10.012	Ø 16			Art. 10.016	□ 14	Art. 10.020	□ 14	Art. 10.020	□ 14	Art. 10.024	□ 14
Art. 10.004.01	Ø 14	Art. 10.008.01	Ø 14	Art. 10.012.01	Ø 14			Art. 10.016.01	□ 16	Art. 10.020.01	□ 16	Art. 10.020.01	□ 16	Art. 10.024.01	□ 16
Art. 10.004.02	Ø 12	Art. 10.008.02	Ø 12	Art. 10.012.02	Ø 12			Art. 10.016.02	□ 12	Art. 10.020.02	□ 12	Art. 10.020.02	□ 12	Art. 10.024.02	□ 12

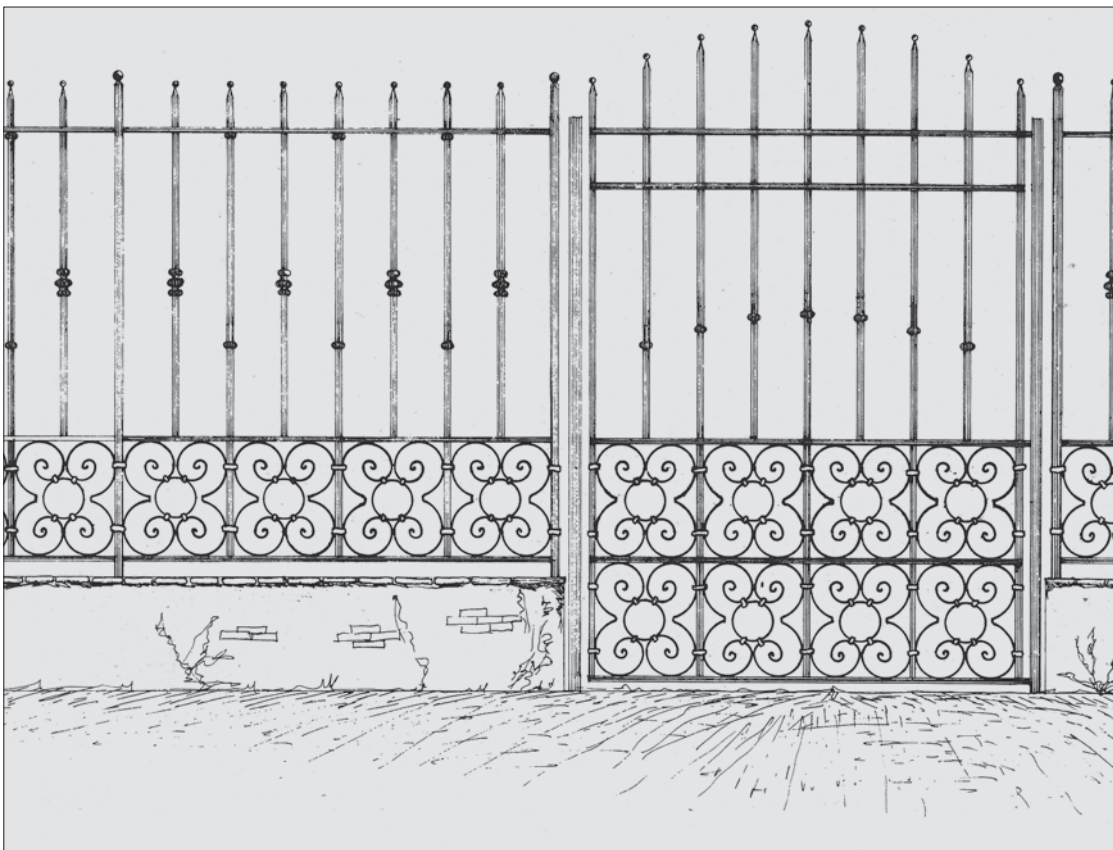

H.1800 mm.	
Art. 10.020.03	□ 14
Art. 10.020.04	□ 16
H.2000 mm.	
Art. 10.020.05	□ 14
Art. 10.020.06	□ 16

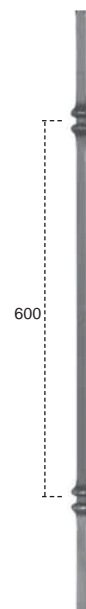

H.1500 mm.	
Art. 10.024.03	□ 14
Art. 10.024.04	□ 16
H.1800 mm.	
Art. 10.024.05	□ 14
Art. 10.024.06	□ 16
H.2000 mm.	
Art. 10.024.07	□ 14
Art. 10.024.08	□ 16

Tutte le parti di questo catalogo - foto comprese - sono di proprietà Euro-Fer. La riproduzione, anche parziale, è vietata in ogni forma e con ogni mezzo. / Every part of this catalogue - photos included - is Euro-Fer's property. All forms of copying are strictly prohibited.



H.950 mm.
Art. 10.025 14
Art. 10.025.01 16
Art. 10.025.02 12
Art. 10.026 \varnothing 16
Art. 10.026.01 \varnothing 14
Art. 10.026.02 \varnothing 12

H.1000 mm.
Art. 10.027 14
Art. 10.027.01 16
Art. 10.027.02 12
Art. 10.028 \varnothing 16
Art. 10.028.01 \varnothing 14
Art. 10.028.02 \varnothing 12

H.1200 mm.
Art. 10.029 14
Art. 10.029.01 16
Art. 10.029.02 12
Art. 10.030 \varnothing 16
Art. 10.030.01 \varnothing 14
Art. 10.030.02 \varnothing 12

H.1500 mm.
Art. 10.031 14
Art. 10.031.01 16
Art. 10.031.02 12
Art. 10.032 \varnothing 16
Art. 10.032.01 \varnothing 14
Art. 10.032.02 \varnothing 12



H.950 mm.
Art. 10.033 14
Art. 10.033.01 16
Art. 10.033.02 12
Art. 10.034 \varnothing 16
Art. 10.034.01 \varnothing 14
Art. 10.034.02 \varnothing 12

H.1000 mm.
Art. 10.035 14
Art. 10.035.01 16
Art. 10.035.02 12
Art. 10.036 \varnothing 16
Art. 10.036.01 \varnothing 14
Art. 10.036.02 \varnothing 12

H.1200 mm.
Art. 10.037 14
Art. 10.037.01 16
Art. 10.037.02 12
Art. 10.038 \varnothing 16
Art. 10.038.01 \varnothing 14
Art. 10.038.02 \varnothing 12

H.1500 mm.
Art. 10.039 14
Art. 10.039.01 16
Art. 10.039.02 12
Art. 10.040 \varnothing 16
Art. 10.040.01 \varnothing 14
Art. 10.040.02 \varnothing 12



Martellato / Hammered

H.950 mm.
Art. 10.040.03 12
Art. 10.040.04 14
Art. 10.040.05 16
H.1000 mm.
Art. 10.040.06 12
Art. 10.040.07 14
Art. 10.040.08 16

H.1200 mm.
Art. 10.040.09 12
Art. 10.040.10 14
Art. 10.040.11 16

H.1500 mm.
Art. 10.040.12 12
Art. 10.040.13 14
Art. 10.040.14 16



Martellato / Hammered

H.950 mm.
Art. 10.040.15 12
Art. 10.040.16 14
Art. 10.040.17 16
H.1000 mm.
Art. 10.040.18 12
Art. 10.040.19 14
Art. 10.040.20 16

H.1200 mm.
Art. 10.040.21 12
Art. 10.040.22 14
Art. 10.040.23 16

H.1500 mm.
Art. 10.040.24 12
Art. 10.040.25 14
Art. 10.040.26 16



Martellato / Hammered

H.950 mm.
Art. 10.041 14
Art. 10.041.01 16
Art. 10.041.02 12
H.1000 mm.
Art. 10.042 14
Art. 10.042.01 16
Art. 10.042.02 12

H.1200 mm.
Art. 10.043 14
Art. 10.043.01 16
Art. 10.043.02 12

H.1500 mm.
Art. 10.044 14
Art. 10.044.01 16
Art. 10.044.02 12



Martellato / Hammered

H.950 mm.
Art. 10.045 14
Art. 10.045.01 16
Art. 10.045.02 12
H.1000 mm.
Art. 10.046 14
Art. 10.046.01 16
Art. 10.046.02 12







H.1200 mm.
Art. 10.047 14
Art. 10.047.01 16
Art. 10.047.02 12

H.1500 mm.
Art. 10.048 14
Art. 10.048.01 16
Art. 10.048.02 12







ELEMENTI IN FERRO RICALCATO
NEW FORGED BARS

Fuori Produzione
Out Of Production

						
Martellato/Hammered	Martellato/Hammered	Fuori Produzione Out Of Production				
H.950 mm.	H.950 mm.	H.950 mm.	H.950 mm.	H.950 mm.	H.950 mm.	H.950 mm.
Art. 10.049 <input type="checkbox"/> 14 Art. 10.049.01 <input type="checkbox"/> 16 Art. 10.049.02 <input type="checkbox"/> 12	Art. 10.053 <input type="checkbox"/> 14 Art. 10.053.01 <input type="checkbox"/> 16 Art. 10.053.02 <input type="checkbox"/> 12	Art. 10.056.03 <input type="checkbox"/> 12 Art. 10.056.04 <input type="checkbox"/> 14 Art. 10.056.05 <input type="checkbox"/> 16	Art. 10.056.15 <input type="checkbox"/> 12 Art. 10.056.16 <input type="checkbox"/> 14 Art. 10.056.17 <input type="checkbox"/> 16	Art. 10.056.27 <input type="checkbox"/> 12 Art. 10.056.28 <input type="checkbox"/> 14 Art. 10.056.29 <input type="checkbox"/> 16	Art. 10.056.39 <input type="checkbox"/> 12 Art. 10.056.40 <input type="checkbox"/> 14 Art. 10.056.41 <input type="checkbox"/> 16	Art. 10.056.51 <input type="checkbox"/> 12 Art. 10.056.52 <input type="checkbox"/> 14 Art. 10.056.53 <input type="checkbox"/> 16
H.1000 mm.	H.1000 mm.	H.1000 mm.	H.1000 mm.	H.1000 mm.	H.1000 mm.	H.1000 mm.
Art. 10.050 <input type="checkbox"/> 14 Art. 10.050.01 <input type="checkbox"/> 16 Art. 10.050.02 <input type="checkbox"/> 12	Art. 10.054 <input type="checkbox"/> 14 Art. 10.054.01 <input type="checkbox"/> 16 Art. 10.054.02 <input type="checkbox"/> 12	Art. 10.056.06 <input type="checkbox"/> 12 Art. 10.056.07 <input type="checkbox"/> 14 Art. 10.056.08 <input type="checkbox"/> 16	Art. 10.056.18 <input type="checkbox"/> 12 Art. 10.056.19 <input type="checkbox"/> 14 Art. 10.056.20 <input type="checkbox"/> 16	Art. 10.056.30 <input type="checkbox"/> 12 Art. 10.056.31 <input type="checkbox"/> 14 Art. 10.056.32 <input type="checkbox"/> 16	Art. 10.056.42 <input type="checkbox"/> 12 Art. 10.056.43 <input type="checkbox"/> 14 Art. 10.056.44 <input type="checkbox"/> 16	Art. 10.056.54 <input type="checkbox"/> 12 Art. 10.056.55 <input type="checkbox"/> 14 Art. 10.056.56 <input type="checkbox"/> 16
H.1200 mm.	H.1200 mm.	H.1200 mm.	H.1200 mm.	H.1200 mm.	H.1200 mm.	H.1200 mm.
Art. 10.051 <input type="checkbox"/> 14 Art. 10.051.01 <input type="checkbox"/> 16 Art. 10.051.02 <input type="checkbox"/> 12	Art. 10.055 <input type="checkbox"/> 14 Art. 10.055.01 <input type="checkbox"/> 16 Art. 10.055.02 <input type="checkbox"/> 12	Art. 10.056.09 <input type="checkbox"/> 12 Art. 10.056.10 <input type="checkbox"/> 14 Art. 10.056.11 <input type="checkbox"/> 16	Art. 10.056.21 <input type="checkbox"/> 12 Art. 10.056.22 <input type="checkbox"/> 14 Art. 10.056.23 <input type="checkbox"/> 16	Art. 10.056.33 <input type="checkbox"/> 12 Art. 10.056.34 <input type="checkbox"/> 14 Art. 10.056.35 <input type="checkbox"/> 16	Art. 10.056.45 <input type="checkbox"/> 12 Art. 10.056.46 <input type="checkbox"/> 14 Art. 10.056.47 <input type="checkbox"/> 16	Art. 10.056.57 <input type="checkbox"/> 12 Art. 10.056.58 <input type="checkbox"/> 14 Art. 10.056.59 <input type="checkbox"/> 16
H.1500 mm.	H.1500 mm.	H.1500 mm.	H.1500 mm.	H.1500 mm.	H.1500 mm.	H.1500 mm.
Art. 10.052 <input type="checkbox"/> 14 Art. 10.052.01 <input type="checkbox"/> 16 Art. 10.052.02 <input type="checkbox"/> 12	Art. 10.056 <input type="checkbox"/> 14 Art. 10.056.01 <input type="checkbox"/> 16 Art. 10.056.02 <input type="checkbox"/> 12	Art. 10.056.12 <input type="checkbox"/> 12 Art. 10.056.13 <input type="checkbox"/> 14 Art. 10.056.14 <input type="checkbox"/> 16	Art. 10.056.24 <input type="checkbox"/> 12 Art. 10.056.25 <input type="checkbox"/> 14 Art. 10.056.26 <input type="checkbox"/> 16	Art. 10.056.36 <input type="checkbox"/> 12 Art. 10.056.37 <input type="checkbox"/> 14 Art. 10.056.38 <input type="checkbox"/> 16	Art. 10.056.48 <input type="checkbox"/> 12 Art. 10.056.49 <input type="checkbox"/> 14 Art. 10.056.50 <input type="checkbox"/> 16	Art. 10.056.60 <input type="checkbox"/> 12 Art. 10.056.61 <input type="checkbox"/> 14 Art. 10.056.62 <input type="checkbox"/> 16
H.1800 mm.						
Art. 10.052.03 <input type="checkbox"/> 12 Art. 10.052.04 <input type="checkbox"/> 14 Art. 10.052.05 <input type="checkbox"/> 16						
H.2000 mm.						
Art. 10.052.06 <input type="checkbox"/> 12 Art. 10.052.07 <input type="checkbox"/> 14 Art. 10.052.08 <input type="checkbox"/> 16						

PALLINE GRANDI / LARGE BALLS

				
H.950 mm.	H.950 mm.	H.950 mm.	H.950 mm.	H.950 mm.
Art. 10.057 <input type="checkbox"/> 14 Art. 10.057.01 <input type="checkbox"/> 16 Art. 10.057.02 <input type="checkbox"/> 12	Art. 10.061 <input type="checkbox"/> 14 Art. 10.061.01 <input type="checkbox"/> 16 Art. 10.061.02 <input type="checkbox"/> 12 Art. 10.062 <input type="checkbox"/> 16 Art. 10.062.01 <input type="checkbox"/> 14 Art. 10.062.02 <input type="checkbox"/> 12	Art. 10.068.60 <input type="checkbox"/> 14 Art. 10.068.61 <input type="checkbox"/> 12	Art. 10.069 <input type="checkbox"/> 14 Art. 10.069.01 <input type="checkbox"/> 16 Art. 10.069.02 <input type="checkbox"/> 12 Art. 10.070 <input type="checkbox"/> 16 Art. 10.070.01 <input type="checkbox"/> 14 Art. 10.070.02 <input type="checkbox"/> 12	Art. 10.077 <input type="checkbox"/> 14 Art. 10.077.01 <input type="checkbox"/> 16 Art. 10.077.02 <input type="checkbox"/> 12 Art. 10.078 <input type="checkbox"/> 16 Art. 10.078.01 <input type="checkbox"/> 14 Art. 10.078.02 <input type="checkbox"/> 12
H.1000 mm.	H.1000 mm.	H.1000 mm.	H.1000 mm.	H.1000 mm.
Art. 10.058 <input type="checkbox"/> 14 Art. 10.058.01 <input type="checkbox"/> 16 Art. 10.058.02 <input type="checkbox"/> 12	Art. 10.063 <input type="checkbox"/> 14 Art. 10.063.01 <input type="checkbox"/> 16 Art. 10.063.02 <input type="checkbox"/> 12 Art. 10.064 <input type="checkbox"/> 16 Art. 10.064.01 <input type="checkbox"/> 14 Art. 10.064.02 <input type="checkbox"/> 12	Art. 10.068.62 <input type="checkbox"/> 14 Art. 10.068.63 <input type="checkbox"/> 12	Art. 10.071 <input type="checkbox"/> 14 Art. 10.071.01 <input type="checkbox"/> 16 Art. 10.071.02 <input type="checkbox"/> 12 Art. 10.072 <input type="checkbox"/> 16 Art. 10.072.01 <input type="checkbox"/> 14 Art. 10.072.02 <input type="checkbox"/> 12	Art. 10.079 <input type="checkbox"/> 14 Art. 10.079.01 <input type="checkbox"/> 16 Art. 10.079.02 <input type="checkbox"/> 12 Art. 10.080 <input type="checkbox"/> 16 Art. 10.080.01 <input type="checkbox"/> 14 Art. 10.080.02 <input type="checkbox"/> 12
H.1200 mm.	H.1200 mm.	H.1200 mm.	H.1200 mm.	H.1200 mm.
Art. 10.059 <input type="checkbox"/> 14 Art. 10.059.01 <input type="checkbox"/> 16 Art. 10.059.02 <input type="checkbox"/> 12	Art. 10.065 <input type="checkbox"/> 14 Art. 10.065.01 <input type="checkbox"/> 16 Art. 10.065.02 <input type="checkbox"/> 12 Art. 10.066 <input type="checkbox"/> 16 Art. 10.066.01 <input type="checkbox"/> 14 Art. 10.066.02 <input type="checkbox"/> 12	Art. 10.068.64 <input type="checkbox"/> 14 Art. 10.068.65 <input type="checkbox"/> 12	Art. 10.073 <input type="checkbox"/> 14 Art. 10.073.01 <input type="checkbox"/> 16 Art. 10.073.02 <input type="checkbox"/> 12 Art. 10.074 <input type="checkbox"/> 16 Art. 10.074.01 <input type="checkbox"/> 14 Art. 10.074.02 <input type="checkbox"/> 12	Art. 10.081 <input type="checkbox"/> 14 Art. 10.081.01 <input type="checkbox"/> 16 Art. 10.081.02 <input type="checkbox"/> 12 Art. 10.082 <input type="checkbox"/> 16 Art. 10.082.01 <input type="checkbox"/> 14 Art. 10.082.02 <input type="checkbox"/> 12
H.1500 mm.	H.1500 mm.	H.1500 mm.	H.1500 mm.	H.1500 mm.
Art. 10.060 <input type="checkbox"/> 14 Art. 10.060.01 <input type="checkbox"/> 16 Art. 10.060.02 <input type="checkbox"/> 12	Art. 10.067 <input type="checkbox"/> 14 Art. 10.067.01 <input type="checkbox"/> 16 Art. 10.067.02 <input type="checkbox"/> 12 Art. 10.068 <input type="checkbox"/> 16 Art. 10.068.01 <input type="checkbox"/> 14 Art. 10.068.02 <input type="checkbox"/> 12	Art. 10.068.66 <input type="checkbox"/> 14 Art. 10.068.67 <input type="checkbox"/> 12	Art. 10.075 <input type="checkbox"/> 14 Art. 10.075.01 <input type="checkbox"/> 16 Art. 10.075.02 <input type="checkbox"/> 12 Art. 10.076 <input type="checkbox"/> 16 Art. 10.076.01 <input type="checkbox"/> 14 Art. 10.076.02 <input type="checkbox"/> 12	Art. 10.083 <input type="checkbox"/> 14 Art. 10.083.01 <input type="checkbox"/> 16 Art. 10.083.02 <input type="checkbox"/> 12 Art. 10.084 <input type="checkbox"/> 16 Art. 10.084.01 <input type="checkbox"/> 14 Art. 10.084.02 <input type="checkbox"/> 12

Tutte le parti di questo catalogo - foto comprese - sono di proprietà Euro-Fer. La riproduzione, anche parziale, è vietata in ogni forma e con ogni mezzo. / Every part of this catalogue - photos included - is Euro-Fer's property. All forms of copying are strictly prohibited.

ELEMENTI IN FERRO RICALCATO NEW FORGED BARS

10

PALLINE GRANDI / LARGE BALLS



H.950 mm. Art. 10.085 □ 14 Art. 10.085.01 □ 16 Art. 10.085.02 □ 12 Art. 10.086 ∅ 16 Art. 10.086.01 ∅ 14 Art. 10.086.02 ∅ 12	H.950 mm. Art. 10.093 □ 14 Art. 10.093.01 □ 16 Art. 10.093.02 □ 12 Art. 10.094 ∅ 16 Art. 10.094.01 ∅ 14 Art. 10.094.02 ∅ 12	H.950 mm. Art. 10.101 □ 14 Art. 10.101.01 □ 16 Art. 10.101.02 □ 12 Art. 10.102 ∅ 16 Art. 10.102.01 ∅ 14 Art. 10.102.02 ∅ 12	H.950 mm. Art. 10.108.60 □ 14 Art. 10.108.61 □ 16 Art. 10.108.62 □ 12 Art. 10.108.63 ∅ 16 Art. 10.108.64 ∅ 14 Art. 10.108.65 ∅ 12	H.950 mm. Art. 10.109 □ 14 Art. 10.109.01 □ 16 Art. 10.109.02 □ 12 Art. 10.110 ∅ 16 Art. 10.110.01 ∅ 14 Art. 10.110.02 ∅ 12	H.950 mm. Art. 10.117 □ 14 Art. 10.117.01 □ 16 Art. 10.117.02 □ 12 Art. 10.118 ∅ 16 Art. 10.118.01 ∅ 14 Art. 10.118.02 ∅ 12	H.950 mm. Art. 10.125 □ 14 Art. 10.125.01 □ 16 Art. 10.125.02 □ 12 Art. 10.126 ∅ 16 Art. 10.126.01 ∅ 14 Art. 10.126.02 ∅ 12
H.1000 mm. Art. 10.087 □ 14 Art. 10.087.01 □ 16 Art. 10.087.02 □ 12 Art. 10.088 ∅ 16 Art. 10.088.01 ∅ 14 Art. 10.088.02 ∅ 12	H.1000 mm. Art. 10.095 □ 14 Art. 10.095.01 □ 16 Art. 10.095.02 □ 12 Art. 10.096 ∅ 16 Art. 10.096.01 ∅ 14 Art. 10.096.02 ∅ 12	H.1000 mm. Art. 10.103 □ 14 Art. 10.103.01 □ 16 Art. 10.103.02 □ 12 Art. 10.104 ∅ 16 Art. 10.104.01 ∅ 14 Art. 10.104.02 ∅ 12	H.1000 mm. Art. 10.108.66 □ 14 Art. 10.108.67 □ 16 Art. 10.108.68 □ 12 Art. 10.108.69 ∅ 16 Art. 10.108.70 ∅ 14 Art. 10.108.71 ∅ 12	H.1000 mm. Art. 10.111 □ 14 Art. 10.111.01 □ 16 Art. 10.111.02 □ 12 Art. 10.112 ∅ 16 Art. 10.112.01 ∅ 14 Art. 10.112.02 ∅ 12	H.1000 mm. Art. 10.119 □ 14 Art. 10.119.01 □ 16 Art. 10.119.02 □ 12 Art. 10.120 ∅ 16 Art. 10.120.01 ∅ 14 Art. 10.120.02 ∅ 12	H.1000 mm. Art. 10.127 □ 14 Art. 10.127.01 □ 16 Art. 10.127.02 □ 12 Art. 10.128 ∅ 16 Art. 10.128.01 ∅ 14 Art. 10.128.02 ∅ 12
H.1200 mm. Art. 10.089 □ 14 Art. 10.089.01 □ 16 Art. 10.089.02 □ 12 Art. 10.090 ∅ 16 Art. 10.090.01 ∅ 14 Art. 10.090.02 ∅ 12	H.1200 mm. Art. 10.097 □ 14 Art. 10.097.01 □ 16 Art. 10.097.02 □ 12 Art. 10.098 ∅ 16 Art. 10.098.01 ∅ 14 Art. 10.098.02 ∅ 12	H.1200 mm. Art. 10.105 □ 14 Art. 10.105.01 □ 16 Art. 10.105.02 □ 12 Art. 10.106 ∅ 16 Art. 10.106.01 ∅ 14 Art. 10.106.02 ∅ 12	H.1200 mm. Art. 10.108.72 □ 14 Art. 10.108.73 □ 16 Art. 10.108.74 □ 12 Art. 10.108.75 ∅ 16 Art. 10.108.76 ∅ 14 Art. 10.108.77 ∅ 12	H.1200 mm. Art. 10.113 □ 14 Art. 10.113.01 □ 16 Art. 10.113.02 □ 12 Art. 10.114 ∅ 16 Art. 10.114.01 ∅ 14 Art. 10.114.02 ∅ 12	H.1200 mm. Art. 10.121 □ 14 Art. 10.121.01 □ 16 Art. 10.121.02 □ 12 Art. 10.122 ∅ 16 Art. 10.122.01 ∅ 14 Art. 10.122.02 ∅ 12	H.1200 mm. Art. 10.129 □ 14 Art. 10.129.01 □ 16 Art. 10.129.02 □ 12 Art. 10.130 ∅ 16 Art. 10.130.01 ∅ 14 Art. 10.130.02 ∅ 12
H.1500 mm. Art. 10.091 □ 14 Art. 10.091.01 □ 16 Art. 10.091.02 □ 12 Art. 10.092 ∅ 16 Art. 10.092.01 ∅ 14 Art. 10.092.02 ∅ 12	H.1500 mm. Art. 10.099 □ 14 Art. 10.099.01 □ 16 Art. 10.099.02 □ 12 Art. 10.100 ∅ 16 Art. 10.100.01 ∅ 14 Art. 10.100.02 ∅ 12	H.1500 mm. Art. 10.107 □ 14 Art. 10.107.01 □ 16 Art. 10.107.02 □ 12 Art. 10.108 ∅ 16 Art. 10.108.01 ∅ 14 Art. 10.108.02 ∅ 12	H.1500 mm. Art. 10.108.78 □ 14 Art. 10.108.79 □ 16 Art. 10.108.80 □ 12 Art. 10.108.81 ∅ 16 Art. 10.108.82 ∅ 14 Art. 10.108.83 ∅ 12	H.1500 mm. Art. 10.115 □ 14 Art. 10.115.01 □ 16 Art. 10.115.02 □ 12 Art. 10.116 ∅ 16 Art. 10.116.01 ∅ 14 Art. 10.116.02 ∅ 12	H.1500 mm. Art. 10.123 □ 14 Art. 10.123.01 □ 16 Art. 10.123.02 □ 12 Art. 10.124 ∅ 16 Art. 10.124.01 ∅ 14 Art. 10.124.02 ∅ 12	H.1500 mm. Art. 10.131 □ 14 Art. 10.131.01 □ 16 Art. 10.131.02 □ 12 Art. 10.132 ∅ 16 Art. 10.132.01 ∅ 14 Art. 10.132.02 ∅ 12

H.950 mm. Art. 10.133 □ 14 Art. 10.133.01 □ 16 Art. 10.133.02 □ 12 Art. 10.134 ∅ 16 Art. 10.134.01 ∅ 14 Art. 10.134.02 ∅ 12	H.950 mm. Art. 10.141 □ 14 Art. 10.141.01 □ 16 Art. 10.141.02 □ 12 Art. 10.142 ∅ 16 Art. 10.142.01 ∅ 14 Art. 10.142.02 ∅ 12	H.950 mm. Art. 10.148.50 □ 12 Art. 10.148.51 □ 14 Art. 10.148.52 □ 16	H.950 mm. Art. 10.149 □ 14 Art. 10.149.01 □ 16 Art. 10.149.02 □ 12
H.1000 mm. Art. 10.135 □ 14 Art. 10.135.01 □ 16 Art. 10.135.02 □ 12 Art. 10.136 ∅ 16 Art. 10.136.01 ∅ 14 Art. 10.136.02 ∅ 12	H.1000 mm. Art. 10.143 □ 14 Art. 10.143.01 □ 16 Art. 10.143.02 □ 12 Art. 10.144 ∅ 16 Art. 10.144.01 ∅ 14 Art. 10.144.02 ∅ 12	H.1000 mm. Art. 10.148.53 □ 12 Art. 10.148.54 □ 14 Art. 10.148.55 □ 16	H.1000 mm. Art. 10.150 □ 14 Art. 10.150.01 □ 16 Art. 10.150.02 □ 12
H.1200 mm. Art. 10.137 □ 14 Art. 10.137.01 □ 16 Art. 10.137.02 □ 12 Art. 10.138 ∅ 16 Art. 10.138.01 ∅ 14 Art. 10.138.02 ∅ 12	H.1200 mm. Art. 10.145 □ 14 Art. 10.145.01 □ 16 Art. 10.145.02 □ 12 Art. 10.146 ∅ 16 Art. 10.146.01 ∅ 14 Art. 10.146.02 ∅ 12	H.1200 mm. Art. 10.148.06 □ 12 Art. 10.148.07 □ 14 Art. 10.148.08 □ 16	H.1200 mm. Art. 10.151 □ 14 Art. 10.151.01 □ 16 Art. 10.151.02 □ 12
H.1500 mm. Art. 10.139 □ 14 Art. 10.139.01 □ 16 Art. 10.139.02 □ 12 Art. 10.140 ∅ 16 Art. 10.140.01 ∅ 14 Art. 10.140.02 ∅ 12	H.1500 mm. Art. 10.147 □ 14 Art. 10.147.01 □ 16 Art. 10.147.02 □ 12 Art. 10.148 ∅ 16 Art. 10.148.01 ∅ 14 Art. 10.148.02 ∅ 12	H.1500 mm. Art. 10.148.09 □ 12 Art. 10.148.10 □ 14 Art. 10.148.11 □ 16	H.1500 mm. Art. 10.152 □ 14 Art. 10.152.01 □ 16 Art. 10.152.02 □ 12

Tutte le parti di questo catalogo - foto comprese - sono di proprietà Euro-Fer. La riproduzione, anche parziale, è vietata in ogni forma e con ogni mezzo. / Every part of this catalogue - photos included - is Euro-Fer's property. All forms of copying are strictly prohibited.

from art. 10.085 to art. 10.152.02

EUROFER

137

PALLINE PICCOLE / SMALL BALLS



Tondo / Round

- H.950 mm.
- Art. 10.152.03 Ø 14
- Art. 10.152.04 Ø 16
- H.1200 mm.
- Art. 10.152.05 Ø 14
- Art. 10.152.06 Ø 16
- H.1500 mm.
- Art. 10.152.07 Ø 14
- Art. 10.152.08 Ø 16
- H.1800 mm.
- Art. 10.152.09 Ø 14
- Art. 10.152.10 Ø 16



- H.1000 mm.
- Art. 10.152.11 □12
- Art. 10.152.12 □14
- Art. 10.152.13 □16
- H.1200 mm.
- Art. 10.152.14 □12
- Art. 10.152.15 □14
- Art. 10.152.16 □16
- H.1500 mm.
- Art. 10.152.17 □12
- Art. 10.152.18 □14
- Art. 10.152.19 □16
- H.1800 mm.
- Art. 10.152.20 □12
- Art. 10.152.21 □14
- Art. 10.152.22 □16



- Tondo / Round
- H.1000 mm.
- Art. 10.152.23 Ø 14
- Art. 10.152.24 Ø 16
- H.1200 mm.
- Art. 10.152.25 Ø 14
- Art. 10.152.26 Ø 16
- H.1500 mm.
- Art. 10.152.27 Ø 14
- Art. 10.152.28 Ø 16
- H.1800 mm.
- Art. 10.152.29 Ø 14
- Art. 10.152.30 Ø 16



- Tondo / Round
- H.950 mm.
- Art. 10.153 Ø 12
- Art. 10.154 Ø 14
- Art. 10.155 Ø 16
- H.1000 mm.
- Art. 10.156 Ø 12
- Art. 10.157 Ø 14
- Art. 10.158 Ø 16
- H.1200 mm.
- Art. 10.159 Ø 12
- Art. 10.160 Ø 14
- Art. 10.161 Ø 16
- H.1500 mm.
- Art. 10.162 Ø 12
- Art. 10.163 Ø 14
- Art. 10.164 Ø 16



- Tondo / Round
- H.950 mm.
- Art. 10.165 Ø 12
- Art. 10.166 Ø 14
- Art. 10.167 Ø 16
- H.1000 mm.
- Art. 10.168 Ø 12
- Art. 10.169 Ø 14
- Art. 10.170 Ø 16
- H.1200 mm.
- Art. 10.171 Ø 12
- Art. 10.172 Ø 14
- Art. 10.173 Ø 16
- H.1500 mm.
- Art. 10.174 Ø 12
- Art. 10.175 Ø 14
- Art. 10.176 Ø 16



- Tondo / Round
- H.950 mm.
- Art. 10.177 Ø 12
- Art. 10.178 Ø 14
- Art. 10.179 Ø 16
- H.1000 mm.
- Art. 10.180 Ø 12
- Art. 10.181 Ø 14
- Art. 10.182 Ø 16
- H.1200 mm.
- Art. 10.183 Ø 12
- Art. 10.184 Ø 14
- Art. 10.185 Ø 16
- H.1500 mm.
- Art. 10.186 Ø 12
- Art. 10.187 Ø 14
- Art. 10.188 Ø 16



- Tondo / Round
- H.950 mm.
- Art. 10.189 Ø 12
- Art. 10.190 Ø 14
- Art. 10.191 Ø 16
- H.1000 mm.
- Art. 10.192 Ø 12
- Art. 10.193 Ø 14
- Art. 10.194 Ø 16
- H.1200 mm.
- Art. 10.195 Ø 12
- Art. 10.196 Ø 14
- Art. 10.197 Ø 16
- H.1500 mm.
- Art. 10.198 Ø 12
- Art. 10.199 Ø 14
- Art. 10.200 Ø 16



- Tondo / Round
- H.950 mm.
- Art. 10.201 Ø 12
- Art. 10.202 Ø 14
- Art. 10.203 Ø 16
- H.1000 mm.
- Art. 10.204 Ø 12
- Art. 10.205 Ø 14
- Art. 10.206 Ø 16
- H.1200 mm.
- Art. 10.207 Ø 12
- Art. 10.208 Ø 14
- Art. 10.209 Ø 16
- H.1500 mm.
- Art. 10.210 Ø 12
- Art. 10.211 Ø 14
- Art. 10.212 Ø 16

PALLINE PICCOLE / SMALL BALLS



- H.950 mm.
- Art. 10.213 □12
- Art. 10.214 □14
- Art. 10.215 □16
- H.1000 mm.
- Art. 10.216 □12
- Art. 10.217 □14
- Art. 10.218 □16
- H.1200 mm.
- Art. 10.219 □12
- Art. 10.220 □14
- Art. 10.221 □16
- H.1500 mm.
- Art. 10.222 □12
- Art. 10.223 □14
- Art. 10.224 □16



- H.950 mm.
- Art. 10.225 □12
- Art. 10.226 □14
- Art. 10.227 □16
- H.1000 mm.
- Art. 10.228 □12
- Art. 10.229 □14
- Art. 10.230 □16
- H.1200 mm.
- Art. 10.231 □12
- Art. 10.232 □14
- Art. 10.233 □16
- H.1500 mm.
- Art. 10.234 □12
- Art. 10.235 □14
- Art. 10.236 □16



- H.950 mm.
- Art. 10.237 □12
- Art. 10.238 □14
- Art. 10.239 □16
- H.1000 mm.
- Art. 10.240 □12
- Art. 10.241 □14
- Art. 10.242 □16
- H.1200 mm.
- Art. 10.243 □12
- Art. 10.244 □14
- Art. 10.245 □16
- H.1500 mm.
- Art. 10.246 □12
- Art. 10.247 □14
- Art. 10.248 □16



- H.950 mm.
- Art. 10.249 □12
- Art. 10.250 □14
- Art. 10.251 □16
- H.1000 mm.
- Art. 10.252 □12
- Art. 10.253 □14
- Art. 10.254 □16
- H.1200 mm.
- Art. 10.255 □12
- Art. 10.256 □14
- Art. 10.257 □16
- H.1500 mm.
- Art. 10.258 □12
- Art. 10.259 □14
- Art. 10.260 □16



- H.950 mm.
- Art. 10.261 □12
- Art. 10.262 □14
- Art. 10.263 □16
- H.1000 mm.
- Art. 10.264 □12
- Art. 10.265 □14
- Art. 10.266 □16
- H.1200 mm.
- Art. 10.267 □12
- Art. 10.268 □14
- Art. 10.269 □16
- H.1500 mm.
- Art. 10.270 □12
- Art. 10.271 □14
- Art. 10.272 □16

Tutte le parti di questo catalogo - foto comprese - sono di proprietà Euro-Fer. La riproduzione, anche parziale, è vietata in ogni forma e con ogni mezzo. / Every part of this catalogue - photos included - is Euro-Fer's property. All forms of copying are strictly prohibited.

PALLINE PICCOLE / SMALL BALLS



*Martellato
Hammered*
H.950 mm.
Art. 10.273 □12
Art. 10.274 □14
Art. 10.275 □16
H.1000 mm.
Art. 10.276 □12
Art. 10.277 □14
Art. 10.278 □16
H.1200 mm.
Art. 10.279 □12
Art. 10.280 □14
Art. 10.281 □16
H.1500 mm.
Art. 10.282 □12
Art. 10.283 □14
Art. 10.284 □16

*Martellato
Hammered*
H.950 mm.
Art. 10.285 □12
Art. 10.286 □14
Art. 10.287 □16
H.1000 mm.
Art. 10.288 □12
Art. 10.289 □14
Art. 10.290 □16
H.1200 mm.
Art. 10.291 □12
Art. 10.292 □14
Art. 10.293 □16
H.1500 mm.
Art. 10.294 □12
Art. 10.295 □14
Art. 10.296 □16

*Martellato
Hammered*
H.950 mm.
Art. 10.297 □12
Art. 10.298 □14
Art. 10.299 □16
H.1000 mm.
Art. 10.300 □12
Art. 10.301 □14
Art. 10.302 □16
H.1200 mm.
Art. 10.303 □12
Art. 10.304 □14
Art. 10.305 □16
H.1500 mm.
Art. 10.306 □12
Art. 10.307 □14
Art. 10.308 □16

*Martellato
Hammered*
H.950 mm.
Art. 10.309 □12
Art. 10.310 □14
Art. 10.311 □16
H.1000 mm.
Art. 10.312 □12
Art. 10.313 □14
Art. 10.314 □16
H.1200 mm.
Art. 10.315 □12
Art. 10.316 □14
Art. 10.317 □16
H.1500 mm.
Art. 10.318 □12
Art. 10.319 □14
Art. 10.320 □16

*Martellato
Hammered*
H.950 mm.
Art. 10.321 □12
Art. 10.322 □14
Art. 10.323 □16
H.1000 mm.
Art. 10.324 □12
Art. 10.325 □14
Art. 10.326 □16
H.1200 mm.
Art. 10.327 □12
Art. 10.328 □14
Art. 10.329 □16
H.1500 mm.
Art. 10.330 □12
Art. 10.331 □14
Art. 10.332 □16

Tondo / Round
H.950 mm.
Art. 10.333 Ø 12
Art. 10.334 Ø 14
Art. 10.335 Ø 16
H.1000 mm.
Art. 10.336 Ø 12
Art. 10.337 Ø 14
Art. 10.338 Ø 16
H.1200 mm.
Art. 10.339 Ø 12
Art. 10.340 Ø 14
Art. 10.341 Ø 16
H.1500 mm.
Art. 10.342 Ø 12
Art. 10.343 Ø 14
Art. 10.344 Ø 16

Tondo / Round
H.950 mm.
Art. 10.345 Ø 12
Art. 10.346 Ø 14
Art. 10.347 Ø 16
H.1000 mm.
Art. 10.348 Ø 12
Art. 10.349 Ø 14
Art. 10.350 Ø 16
H.1200 mm.
Art. 10.351 Ø 12
Art. 10.352 Ø 14
Art. 10.353 Ø 16
H.1500 mm.
Art. 10.354 Ø 12
Art. 10.355 Ø 14
Art. 10.356 Ø 16

PALLINE PICCOLE / SMALL BALLS

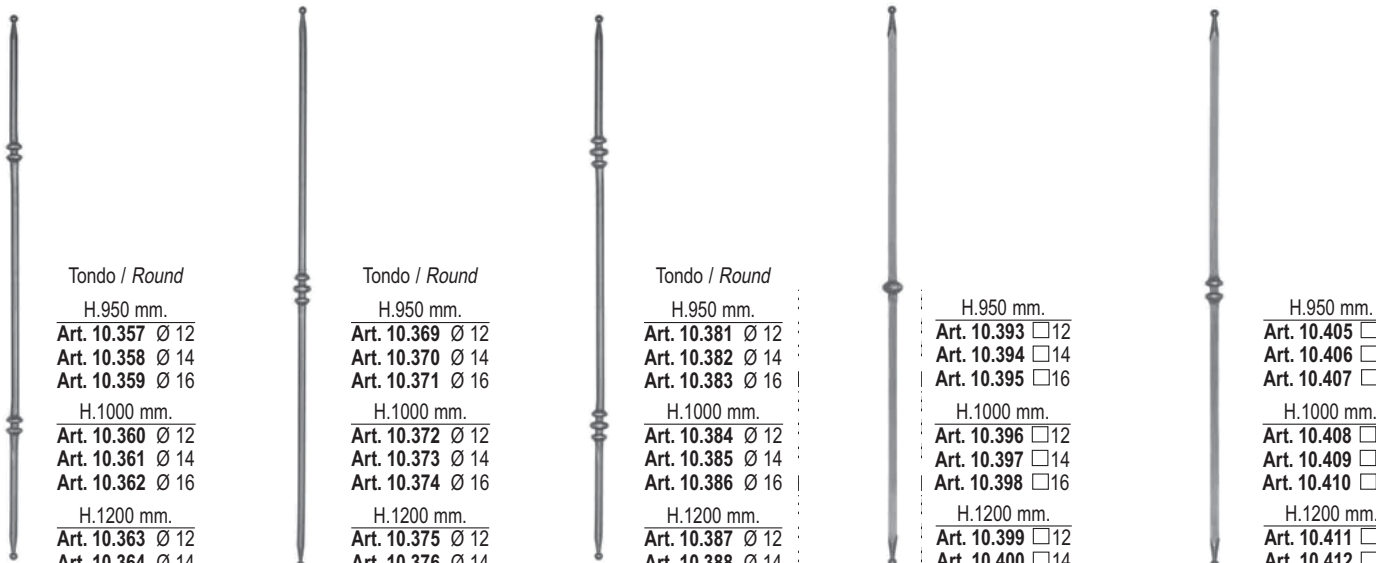

Tondo / Round
H.950 mm.
Art. 10.357 Ø 12
Art. 10.358 Ø 14
Art. 10.359 Ø 16
H.1000 mm.
Art. 10.360 Ø 12
Art. 10.361 Ø 14
Art. 10.362 Ø 16
H.1200 mm.
Art. 10.363 Ø 12
Art. 10.364 Ø 14
Art. 10.365 Ø 16
H.1500 mm.
Art. 10.366 Ø 12
Art. 10.367 Ø 14
Art. 10.368 Ø 16

Tondo / Round
H.950 mm.
Art. 10.369 Ø 12
Art. 10.370 Ø 14
Art. 10.371 Ø 16
H.1000 mm.
Art. 10.372 Ø 12
Art. 10.373 Ø 14
Art. 10.374 Ø 16
H.1200 mm.
Art. 10.375 Ø 12
Art. 10.376 Ø 14
Art. 10.377 Ø 16
H.1500 mm.
Art. 10.378 Ø 12
Art. 10.379 Ø 14
Art. 10.380 Ø 16

Tondo / Round
H.950 mm.
Art. 10.381 Ø 12
Art. 10.382 Ø 14
Art. 10.383 Ø 16
H.1000 mm.
Art. 10.384 Ø 12
Art. 10.385 Ø 14
Art. 10.386 Ø 16
H.1200 mm.
Art. 10.387 Ø 12
Art. 10.388 Ø 14
Art. 10.389 Ø 16
H.1500 mm.
Art. 10.390 Ø 12
Art. 10.391 Ø 14
Art. 10.392 Ø 16

H.950 mm.
Art. 10.393 □12
Art. 10.394 □14
Art. 10.395 □16
H.1000 mm.
Art. 10.396 □12
Art. 10.397 □14
Art. 10.398 □16
H.1200 mm.
Art. 10.399 □12
Art. 10.400 □14
Art. 10.401 □16
H.1500 mm.
Art. 10.402 □12
Art. 10.403 □14
Art. 10.404 □16

H.950 mm.
Art. 10.405 □12
Art. 10.406 □14
Art. 10.407 □16
H.1000 mm.
Art. 10.408 □12
Art. 10.409 □14
Art. 10.410 □16
H.1200 mm.
Art. 10.411 □12
Art. 10.412 □14
Art. 10.413 □16
H.1500 mm.
Art. 10.414 □12
Art. 10.415 □14
Art. 10.416 □16

Tutte le parti di questo catalogo - foto comprese - sono di proprietà Euro-Fer. La riproduzione, anche parziale, è vietata in ogni forma e con ogni mezzo. / Every part of this catalogue - photos included - is Euro-Fer's property. All forms of copying are strictly prohibited.

PALLINE PICCOLE / SMALL BALLS



H.950 mm.
Art. 10.417 □12
Art. 10.418 □14
Art. 10.419 □16

H.950 mm.
Art. 10.429 □12
Art. 10.430 □14
Art. 10.431 □16

H.950 mm.
Art. 10.441 □12
Art. 10.442 □14
Art. 10.443 □16

Martellato
Hammered
H.950 mm.
Art. 10.453 □12
Art. 10.454 □14
Art. 10.455 □16

Martellato
Hammered
H.950 mm.
Art. 10.465 □12
Art. 10.466 □14
Art. 10.467 □16

Martellato
Hammered
H.950 mm.
Art. 10.477 □12
Art. 10.478 □14
Art. 10.479 □16

Martellato
Hammered
H.950 mm.
Art. 10.489 □12
Art. 10.490 □14
Art. 10.491 □16

H.1000 mm.
Art. 10.420 □12
Art. 10.421 □14
Art. 10.422 □16

H.1000 mm.
Art. 10.432 □12
Art. 10.433 □14
Art. 10.434 □16

H.1000 mm.
Art. 10.444 □12
Art. 10.445 □14
Art. 10.446 □16

H.1000 mm.
Art. 10.456 □12
Art. 10.457 □14
Art. 10.458 □16

H.1000 mm.
Art. 10.468 □12
Art. 10.469 □14
Art. 10.470 □16

H.1000 mm.
Art. 10.480 □12
Art. 10.481 □14
Art. 10.482 □16

H.1000 mm.
Art. 10.492 □12
Art. 10.493 □14
Art. 10.494 □16

H.1200 mm.
Art. 10.423 □12
Art. 10.424 □14
Art. 10.425 □16

H.1200 mm.
Art. 10.435 □12
Art. 10.436 □14
Art. 10.437 □16

H.1200 mm.
Art. 10.447 □12
Art. 10.448 □14
Art. 10.449 □16

H.1200 mm.
Art. 10.459 □12
Art. 10.460 □14
Art. 10.461 □16

H.1200 mm.
Art. 10.471 □12
Art. 10.472 □14
Art. 10.473 □16

H.1200 mm.
Art. 10.483 □12
Art. 10.484 □14
Art. 10.485 □16

H.1200 mm.
Art. 10.495 □12
Art. 10.496 □14
Art. 10.497 □16

H.1500 mm.
Art. 10.426 □12
Art. 10.427 □14
Art. 10.428 □16

H.1500 mm.
Art. 10.438 □12
Art. 10.439 □14
Art. 10.440 □16

H.1500 mm.
Art. 10.450 □12
Art. 10.451 □14
Art. 10.452 □16

H.1500 mm.
Art. 10.462 □12
Art. 10.463 □14
Art. 10.464 □16

H.1500 mm.
Art. 10.474 □12
Art. 10.475 □14
Art. 10.476 □16

H.1500 mm.
Art. 10.486 □12
Art. 10.487 □14
Art. 10.488 □16

H.1500 mm.
Art. 10.498 □12
Art. 10.499 □14
Art. 10.500 □16

PALLINE PICCOLE / SMALL BALLS



Martellato
Hammered

H.950 mm.
Art. 10.501 □12
Art. 10.502 □14
Art. 10.503 □16

H.1000 mm.
Art. 10.504 □12
Art. 10.505 □14
Art. 10.506 □16

H.1200 mm.
Art. 10.507 □12
Art. 10.508 □14
Art. 10.509 □16

H.1500 mm.
Art. 10.510 □12
Art. 10.511 □14
Art. 10.512 □16

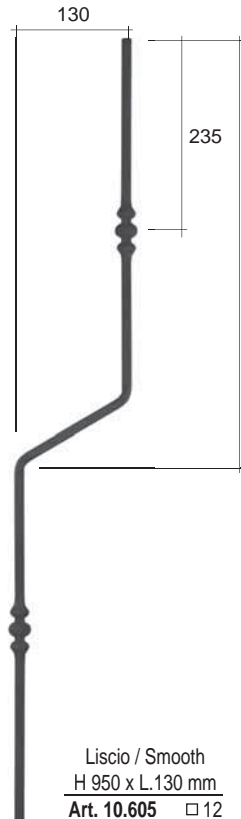

Nuovi ricalcati corteccia e rigati martellati / New forged bars bark model and fluted hammered



Corteccia / Bark model
H.950 mm

- Art. 10.001.CO Ø 16
- Art. 10.001.01.CO Ø 14
- Art. 10.001.02.CO Ø 12
- Art. 10.013.CO □ 14
- Art. 10.013.01.CO □ 16
- Art. 10.013.02.CO □ 12
- H.1000 mm
- Art. 10.002.CO Ø 16
- Art. 10.002.01.CO Ø 14
- Art. 10.002.02.CO Ø 12
- Art. 10.014.CO □ 14
- Art. 10.014.01.CO □ 16
- Art. 10.014.02.CO □ 12

Rigato Martellato /
Fluted Hammered
H.950 mm

- Art. 10.013.RM □ 14
- Art. 10.013.01.RM □ 16
- Art. 10.013.02.RM □ 12



Corteccia / Bark model
H.950 mm

- Art. 10.040.15.CO □ 12
- Art. 10.040.16.CO □ 14
- Art. 10.040.17.CO □ 16
- H.1000 mm
- Art. 10.040.18.CO □ 12
- Art. 10.040.19.CO □ 14
- Art. 10.040.20.CO □ 16

Rigato Martellato /
Fluted Hammered
H.950 mm

- Art. 10.040.15.RM □ 12
- Art. 10.040.16.RM □ 14
- Art. 10.040.17.RM □ 16



Corteccia / Bark model
H.950 mm

- Art. 10.005.CO Ø 16
- Art. 10.005.01.CO Ø 14
- Art. 10.005.02.CO Ø 12
- Art. 10.017.CO □ 14
- Art. 10.017.01.CO □ 16
- Art. 10.017.02.CO □ 12
- H.1000 mm
- Art. 10.006.CO Ø 16
- Art. 10.006.01.CO Ø 14
- Art. 10.006.02.CO Ø 12
- Art. 10.018.CO □ 14
- Art. 10.018.01.CO □ 16
- Art. 10.018.02.CO □ 12

Rigato Martellato /
Fluted Hammered
H.950 mm

- Art. 10.017.RM □ 14
- Art. 10.017.01.RM □ 16
- Art. 10.017.02.RM □ 12



Corteccia / Bark model
H.950 mm

- Art. 10.009.CO Ø 16
- Art. 10.009.01.CO Ø 14
- Art. 10.009.02.CO Ø 12
- Art. 10.021.CO □ 14
- Art. 10.021.01.CO □ 16
- Art. 10.021.02.CO □ 12
- H.1000 mm
- Art. 10.010.CO Ø 16
- Art. 10.010.01.CO Ø 14
- Art. 10.010.02.CO Ø 12
- Art. 10.022.CO □ 14
- Art. 10.022.01.CO □ 16
- Art. 10.022.02.CO □ 12

Rigato Martellato /
Fluted Hammered
H.950 mm

- Art. 10.021.RM □ 14
- Art. 10.021.01.RM □ 16
- Art. 10.021.02.RM □ 12



Corteccia / Bark model
H.950 mm

- Art. 10.026.CO Ø 16
- Art. 10.026.01.CO Ø 14
- Art. 10.026.02.CO Ø 12
- Art. 10.025.CO □ 14
- Art. 10.025.01.CO □ 16
- Art. 10.025.02.CO □ 12
- H.1000 mm
- Art. 10.028.CO Ø 16
- Art. 10.028.01.CO Ø 14
- Art. 10.028.02.CO Ø 12
- Art. 10.027.CO □ 14
- Art. 10.027.01.CO □ 16
- Art. 10.027.02.CO □ 12

Rigato Martellato /
Fluted Hammered
H.950 mm

- Art. 10.025.RM □ 14
- Art. 10.025.01.RM □ 16
- Art. 10.025.02.RM □ 12



Corteccia / Bark model
H.950 mm

- Art. 10.034.CO Ø 16
- Art. 10.034.01.CO Ø 14
- Art. 10.034.02.CO Ø 12
- Art. 10.033.CO □ 14
- Art. 10.033.01.CO □ 16
- Art. 10.033.02.CO □ 12
- H.1000 mm
- Art. 10.036.CO Ø 16
- Art. 10.036.01.CO Ø 14
- Art. 10.036.02.CO Ø 12
- Art. 10.035.CO □ 14
- Art. 10.035.01.CO □ 16
- Art. 10.035.02.CO □ 12

Rigato Martellato /
Fluted Hammered
H.950 mm

- Art. 10.033.RM □ 14
- Art. 10.033.01.RM □ 16
- Art. 10.033.02.RM □ 12



.RM
rigati martellati
fluted hammered



.CO
corteccia
bark model



.CO
corteccia
bark model



.CO
corteccia
bark model



.CO
corteccia
bark model



.CO
corteccia
bark model

Tutte le parti di questo catalogo - foto comprese - sono di proprietà Euro-Fer. La riproduzione, anche parziale, è vietata in ogni forma e con ogni mezzo. / Every part of this catalogue - photos included - is Euro-Fer's property. All forms of copying are strictly prohibited.



Art.11001L.T12.950
Art.11001L.T12.1000
Art.11001L.T12.1200
Art.11001L.T12.1500

Art.11001.01L.T12.1000
Art.11001.01L.T14.1000
Art.11001.01L.T16.1000

Art.11001L.T14.950
Art.11001L.T14.1000
Art.11001L.T14.1200
Art.11001L.T14.1500

Art.11001L.T16.950
Art.11001L.T16.1000
Art.11001L.T16.1200
Art.11001L.T16.1500

Art.11002L.Q12.950
Art.11002F.Q12.950
Art.11002M.Q12.950

Art.11002L.Q12.1000
Art.11002F.Q12.1000
Art.11002M.Q12.1000
Art.11002L.Q12.1200
Art.11002F.Q12.1200
Art.11002M.Q12.1200

Art.11002L.Q12.1500
Art.11002F.Q12.1500
Art.11002M.Q12.1500

Art.11002L.Q14.950
Art.11002F.Q14.950
Art.11002M.Q14.950

Art.11002L.Q14.1000
Art.11002F.Q14.1000
Art.11002M.Q14.1000

Art.11002L.Q14.1200
Art.11002F.Q14.1200
Art.11002M.Q14.1200

Art.11002L.Q14.1500
Art.11002F.Q14.1500
Art.11002M.Q14.1500

Art.11002L.Q16.950
Art.11002L.Q16.1000
Art.11002L.Q16.1200
Art.11002L.Q16.1500

Art.11003L.Q12.1000
Art.11003F.Q12.1000

Art.11003L.Q14.1000
Art.11003F.Q14.1000

Art.11003L.Q16.1000

Art.11002S.Q12.950
Art.11002S.Q12.1000
Art.11002S.Q12.1200
Art.11002S.Q12.1500

Art.11003.01L.T12.950
Art.11003.01F.T12.950

Art.11003.01L.T12.1000
Art.11003.01F.T12.1000

Art.11003.01L.T12.1200
Art.11003.01F.T12.1200

Art.11003.01L.T12.1500
Art.11003.01F.T12.1500

Art.11003.01L.T14.950
Art.11003.01L.T14.1000
Art.11003.01L.T14.1200
Art.11003.01L.T14.1500

LEGENDA / LEGEND

Q = QUADRO/SQUARE IRON
T = TONDO/ROUND IRON

F = FORGIATO/FORGED
L = LISCIO/SMOOTH
M = MARTELLATO/HAMMERED
S = SMUSSATO/BLUNTED

LE MISURE SONO IN
MILLIMETRI / SIZES ARE IN MM



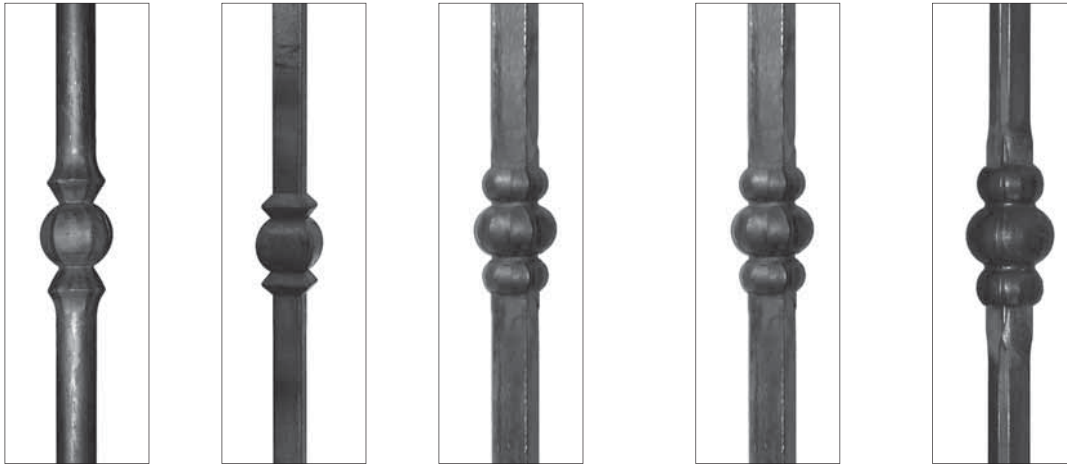

Art.11003.02L.T12.1000
Art.11003.02F.T12.1000

Art. 11004L.Q12.1000
Art. 11004L.Q12.1200
Art. 11004F.Q12.1000
Art. 11004F.Q12.1200

Art.11008L.Q12.950
Art.11008F.Q12.950
Art.11008M.Q12.950

Art.11008L.Q12.1000
Art.11008F.Q12.1000
Art.11008M.Q12.1000

Art.11008L.Q12.1200
Art.11008F.Q12.1200
Art.11008M.Q12.1200

Art.11008L.Q12.1500
Art.11008F.Q12.1500
Art.11008M.Q12.1500

Art.11008L.Q14.950
Art.11008F.Q14.950
Art.11008M.Q14.950
Art.11008L.Q14.1000
Art.11008F.Q14.1000
Art.11008M.Q14.1000

Art.11008L.Q14.1200
Art.11008F.Q14.1200
Art.11008M.Q14.1200
Art.11008L.Q14.1500
Art.11008F.Q14.1500
Art.11008M.Q14.1500

Art.11008.01L.Q12.1000
Art.11008.01F.Q12.1000
Art.11008.01M.Q12.1000

Art.11008.01L.Q14.1000
Art.11008.01F.Q14.1000
Art.11008.01M.Q14.1000

Art.11008S.Q12.950
Art.11008S.Q12.1000
Art.11008S.Q12.1200
Art.11008S.Q12.1500



SU RICHIESTA / ON REQUEST

Tutti gli articoli di questo catalogo possono essere realizzati con queste lance / All articles in this catalogue can be realized with these spears.

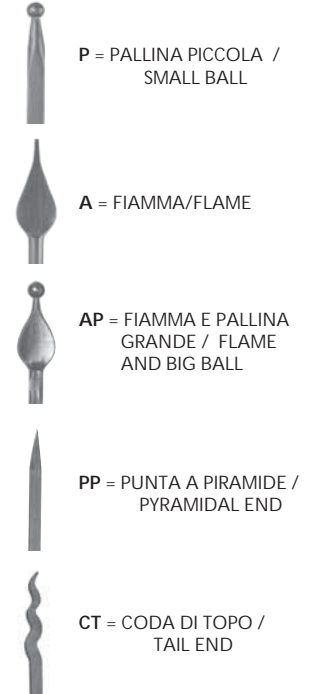

Per ordinare i paletti seguire l'esempio / To order bars please follow the example:

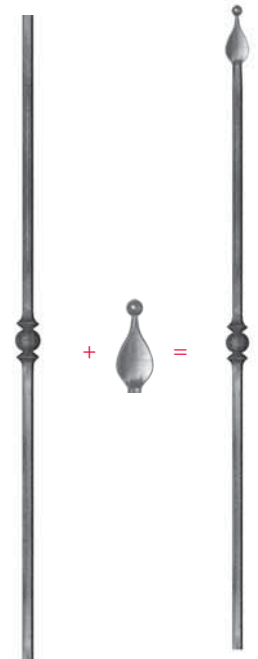

11002L.Q12.950 + AP
= 11002L.Q12.950AP

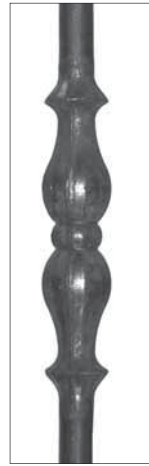

Art.11008.04L.T12.950
Art.11008.04L.T12.1000
Art.11008.04L.T12.1200
Art.11008.04L.T12.1500

Art. 11014.10L.T12.1000
Art. 11014.10L.T12.1200
Art. 11014.10F.T12.1000
Art. 11014.10F.T12.1200

Art.11017.03L.T12.950
Art.11017.03F.T12.950

Art.11017.03L.T12.1000
Art.11017.03F.T12.1000

Art.11017.03L.T12.1200
Art.11017.03F.T12.1200

Art.11017.03L.T12.1500
Art.11017.03F.T12.1500

Art.11017.05L.T14.950
Art.11017.05L.T14.1000
Art.11017.05L.T14.1200
Art.11017.05L.T14.1500

Art.11017.01L.T12.950
Art.11017.01F.T12.950

Art.11017.01L.T12.1000
Art.11017.01F.T12.1000

Art.11017.01L.T12.1200
Art.11017.01F.T12.1200

Art.11017.01L.T12.1500
Art.11017.01F.T12.1500

Art.11023.04L.T.12.950
Art.11023.04L.T12.1000
Art.11023.04L.T12.1200
Art.11023.04L.T12.1500

Art. 11041.36L.T12.1000
Art. 11041.36L.T12.1200
Art. 11041.36F.T12.1000
Art. 11041.36F.T12.1200

Art.11017.01L.T14.950
Art.11017.01F.T14.950

Art.11017.01L.T14.1000
Art.11017.01F.T14.1000

Art.11017.01L.T14.1200
Art.11017.01F.T14.1200

Art.11017.01L.T14.1500
Art.11017.01F.T14.1500

LEGENDA / LEGEND

Q = QUADRO/SQUARE IRON
T = TONDO/ROUND IRON

F = FORGIATO/FORGED
L = LISCIO/SMOOTH
M = MARTELLATO/HAMMERED
S = SMUSSATO/BLUNTED

LE MISURE SONO IN
MILLIMETRI / SIZES ARE IN MM

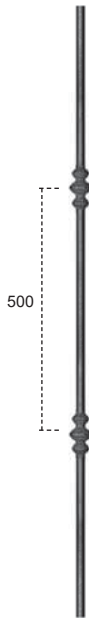

Art.11041.54L.Q12.950
Art.11041.54L.T12.950

Art.11041.55L.Q12.1000
Art.11041.55L.T12.1000

Art.11041.58L.T12.950
Art.11041.58L.Q12.950

Art.11041.60L.Q12.950
Art.11041.60L.Q12.1000

Art.11041.68L.T12.950
Art.11041.68L.T12.1000

Art.11041.70L.Q14.950
Art.11041.70L.Q14.1000
Art.11041.70L.Q14.1200
Art.11041.70L.Q14.1500

Art.11041.54L.Q12.1000
Art.11041.54L.T12.1000

Art.11041.55L.Q14.1000
Art.11041.55L.T14.1000

Art.11041.58L.T12.1000
Art.11041.58L.Q12.1000

Art.11041.54L.Q12.1200
Art.11041.54L.T12.1200

Art.11041.58L.T12.1200
Art.11041.58L.Q12.1200

Art.11041.54L.Q12.1500
Art.11041.54L.T12.1500

Art.11041.58L.T12.1500
Art.11041.58L.Q12.1500

Art.11041.54L.Q14.950
Art.11041.54L.T14.950

Art.11041.58L.T14.1000
Art.11041.58L.Q14.1000

Art.11041.54L.Q14.1000
Art.11041.54L.T14.1000

Art.11041.54L.Q14.1200
Art.11041.54L.T14.1200

Art.11041.54L.Q14.1500
Art.11041.54L.T14.1500

LEGENDA / LEGEND

Q = QUADRO/SQUARE IRON
T = TONDO/ROUND IRON

F = FORGIATO/FORGED
L = LISCIO/SMOOTH
M = MARTELLATO/HAMMERED
S = SMUSSATO/BLUNTED

LE MISURE SONO IN
MILLIMETRI / SIZES ARE IN MM



SU RICHIESTA / ON REQUEST

Tutti gli articoli di questo catalogo possono essere realizzati con queste lance / All articles in this catalogue can be realized with these spears.



P = PALLINA PICCOLA / SMALL BALL



A = FIAMMA/FLAME



AP = FIAMMA E PALLINA GRANDE / FLAME AND BIG BALL



PP = PUNTA A PIRAMIDE / PYRAMIDAL END



CT = CODA DI TOPO / TAIL END

Per ordinare i paletti seguire l'esempio / To order bars please follow the example:

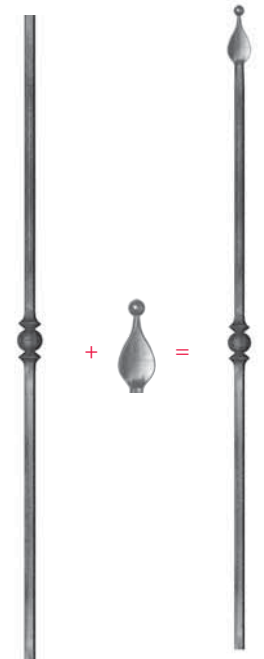

11002L.Q12.950 + AP = 11002L.Q12.950AP



Art.11098.02L.Q14.950
Art.11098.02L.Q14.1200
Art.11098.02L.Q14.1500
Art.11098.02L.Q14.1800



Art.11098.04L.T12.950
Art.11098.04L.T12.1200
Art.11098.04L.T12.1500
Art.11098.04L.T12.1800



Art.11090.01L.Q12.1000
Art.11090.01L.Q12.1200
Art.11090.01L.Q12.1500
Art.11090.01L.Q12.1800



Art.11091.01L.T12.1000
Art.11091.01L.T12.1200
Art.11091.01L.T12.1500
Art.11091.01L.T12.1800

LEGENDA / LEGEND

Q = QUADRO/SQUARE IRON
T = TONDO/ROUND IRON

F = FORGIATO/FORGED
L = LISCIO/SMOOTH
M = MARTELLATO/HAMMERED
S = SMUSSATO/BLUNTED

LE MISURE SONO IN MILLIMETRI / SIZES ARE IN MM



Art. 11002P.Q12.950
Art. 11002P.Q12.1000
Art. 11002P.Q12.1200
Art. 11002P.Q12.1500
Art. 11002P.Q12.3000
Art. 11002P.Q12.6000



Art. 11002P.Q14.950
Art. 11002P.Q14.1000
Art. 11002P.Q14.1200
Art. 11002P.Q14.1500
Art. 11002P.Q14.3000
Art. 11002P.Q14.6000



Art. 11017.01P.T12.950
Art. 11017.01P.T12.1000
Art. 11017.01P.T12.1200
Art. 11017.01P.T12.1500
Art. 11017.01P.T12.3000
Art. 11017.01P.T12.6000



Art. 11017.01P.T14.950
Art. 11017.01P.T14.1000
Art. 11017.01P.T14.1200
Art. 11017.01P.T14.1500
Art. 11017.01P.T14.3000
Art. 11017.01P.T14.6000

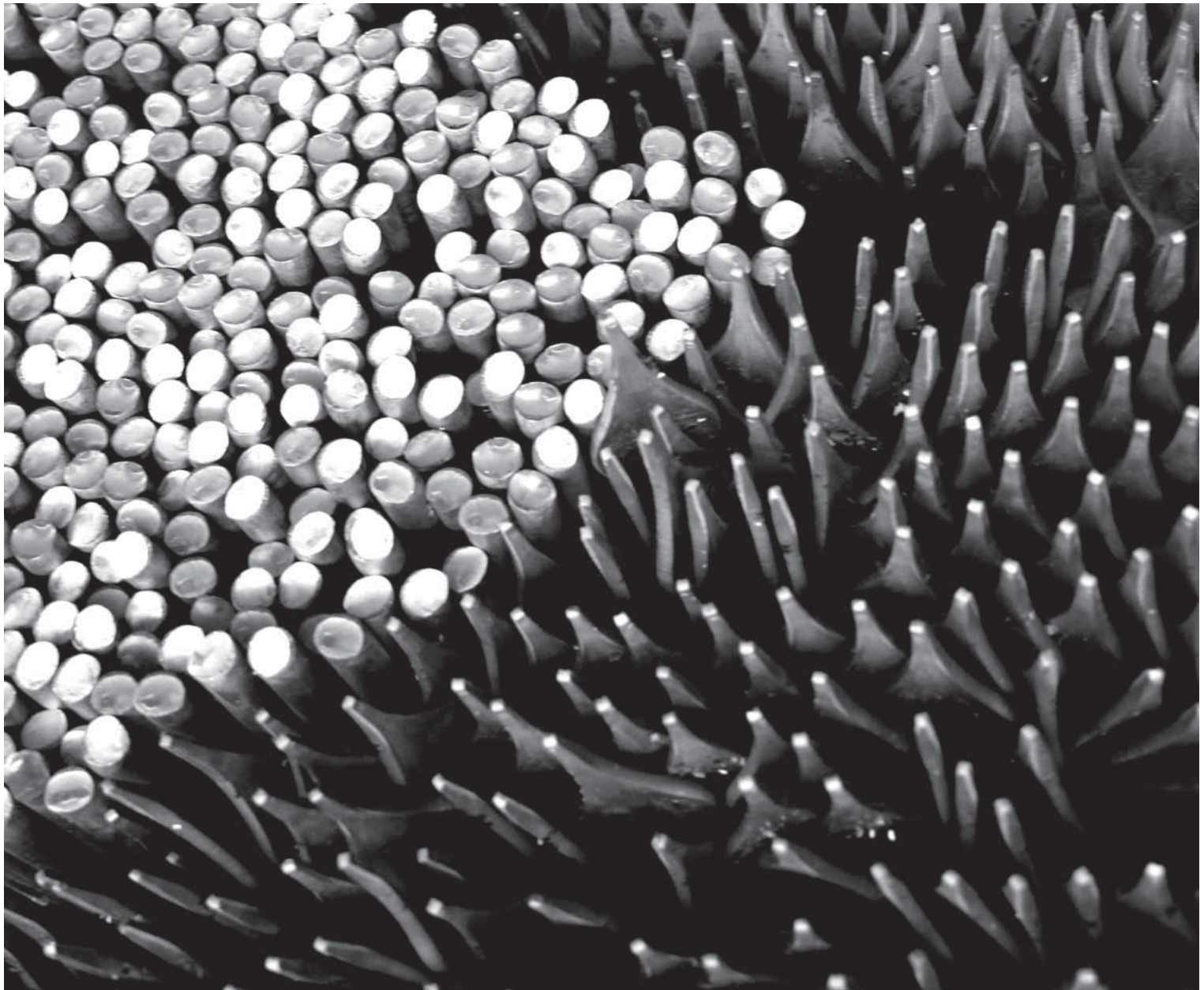

ELEMENTI IN FERRO FORGIATO E CAPISALDI
FORGED BARS AND POSTS



H.1000 mm.
Art. 11.001
Ø 14 circa



H.1000 mm.
Art. 11.001.01
Ø 14 circa



H.1000mm.
Art. 11.002.P □ 14



H.1000 mm.
Art. 11.002 □ 14 circa
Art. 11.002.E □ 10 circa
Art. 11.002.D □ 12 circa



H.1000 mm.
Art. 11.003 □ 14 circa
Art. 11.003.E □ 10 circa
Art. 11.003.D □ 12 circa

Rastrematō / Tapered
H.1000 mm.
Art. 11.003.01.P
Ø 14 mm



H.1000 mm.
Art. 11.003.01
Ø 14 circa
Art. 11.003.01.E
Ø 12 circa



H.1000 mm.
Art. 11.003.02
Ø 14 circa
Art. 11.003.02.E
Ø 12 circa



H.1000 mm.
Art. 11.003.03
Ø 14 mm



H.1000 mm.
Art. 11.003.04
Ø 14 mm



H.1000 mm.
Art. 11.004
□ 14 circa



H.1000 mm.
Art. 11.004.01
□ 14 circa



H.1000 mm.
Art. 11.004.02
□ 14 circa



H.1000 mm.
Art. 11.005
□ 14 circa



H.1000 mm.
Art. 11.006
□ 14 circa
Art. 11.006.01
Ø 14 circa



H.1000 mm.
Art. 11.007
□ 14 circa
Art. 11.007.01
Ø 14 circa



H.1000 mm.
Art. 11.008
□ 14 circa



H.1000 mm.
Art. 11.008.01
□ 14 circa



H.1000 mm.
Art. 11.008.02
Ø 14 circa



H.1000 mm.
Art. 11.008.03
Ø 14 circa



H.1000 mm.
Art. 11.008.04
Ø 12 circa



H.1000 mm.
Art. 11.008.05
Ø 12 circa



H.1000 mm
Art. 11.008.06
□ 12 circa

Smussato / Blunted



H.1000 mm
Art. 11.008.07
□ 12 circa

Smussato / Blunted

Tutte le parti di questo catalogo - foto comprese - sono di proprietà Euro-Fer. La riproduzione, anche parziale, è vietata in ogni forma e con ogni mezzo. / Every part of this catalogue - photos included - is Euro-Fer's property. All forms of copying are strictly prohibited.

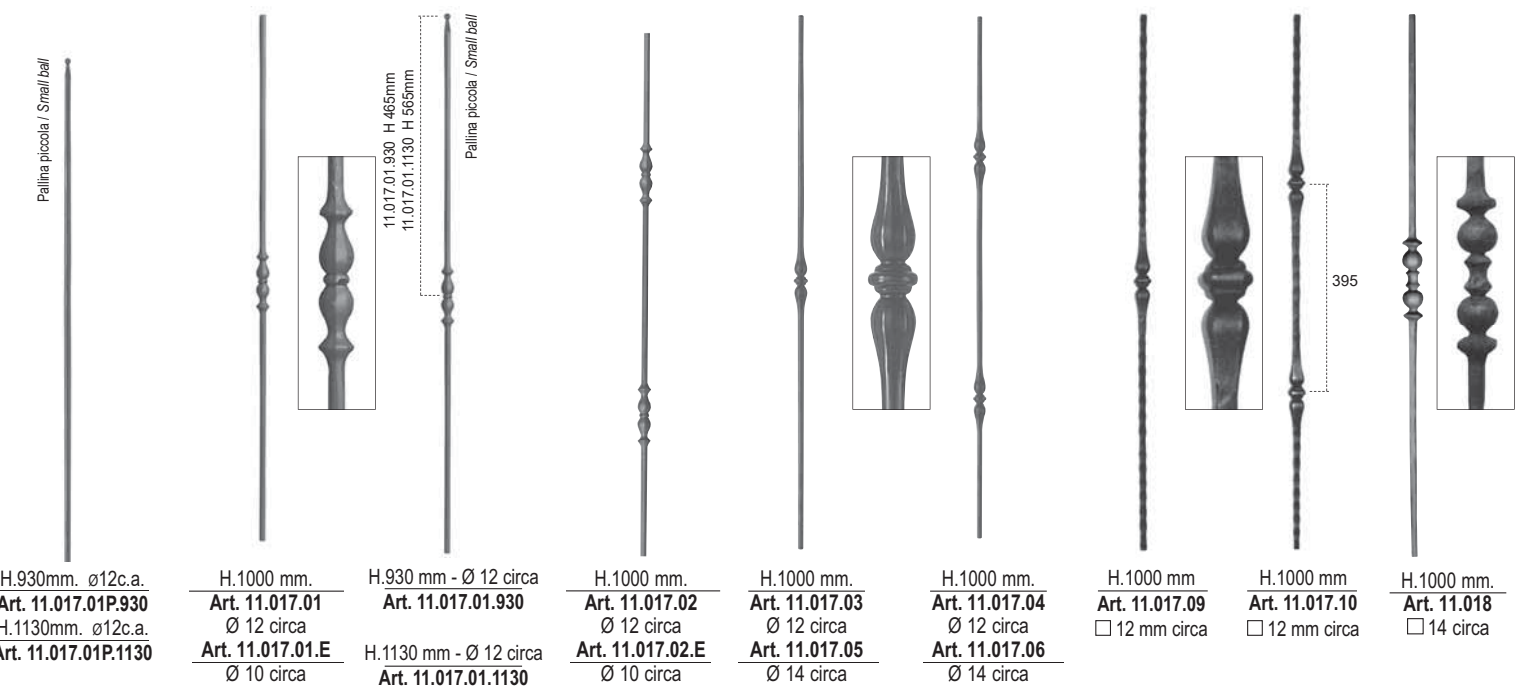
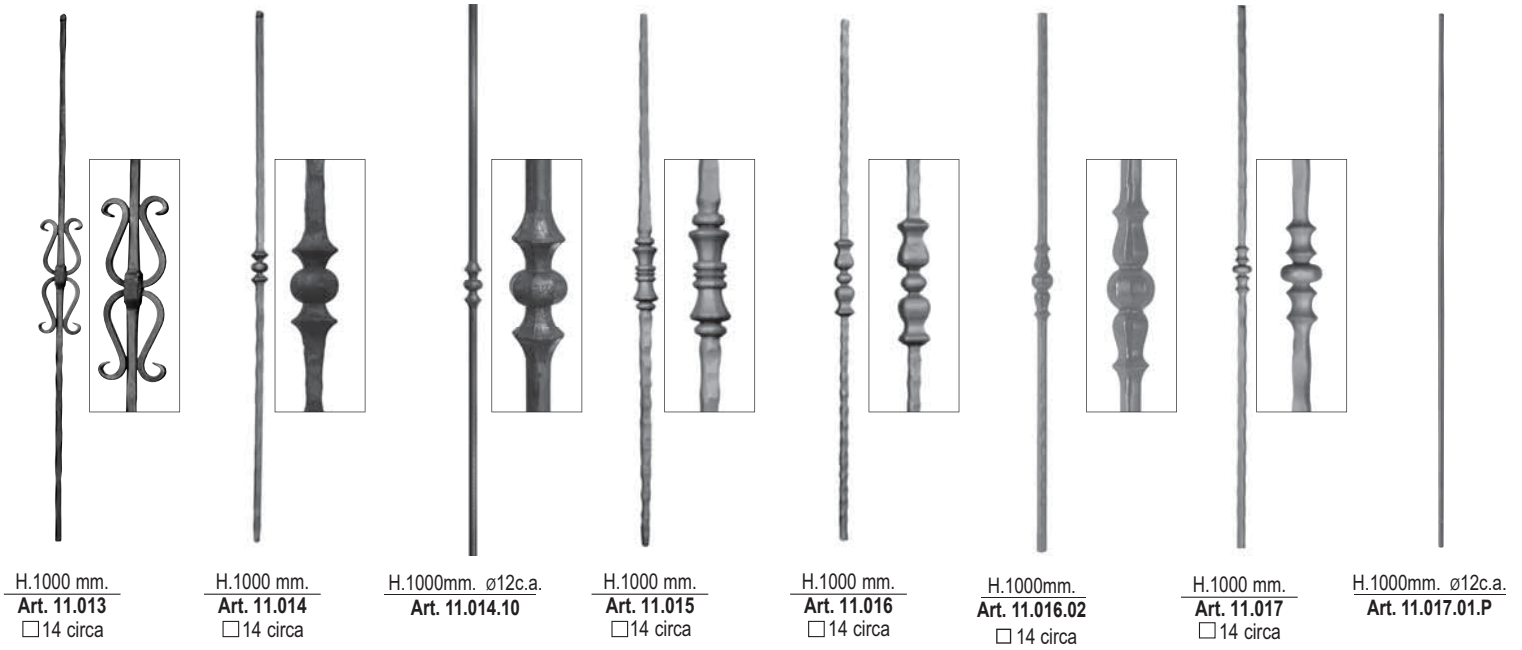
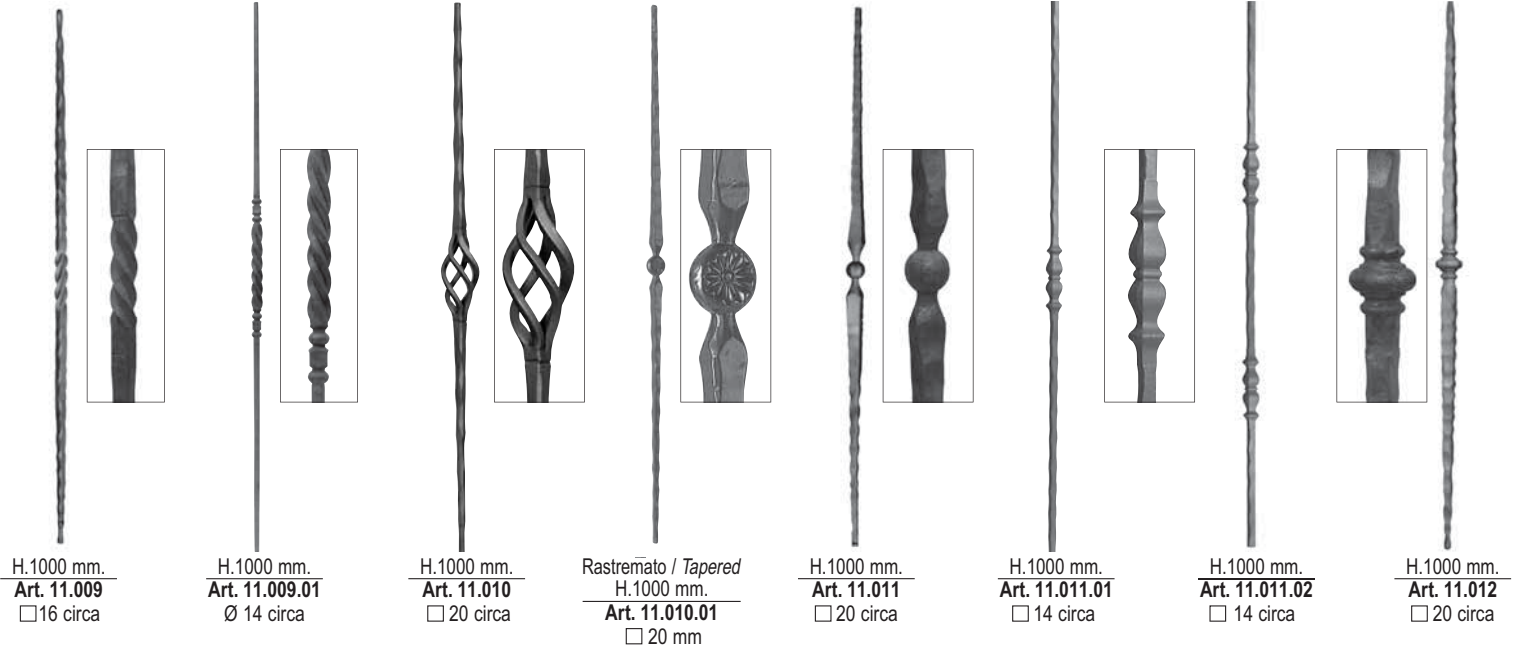

ELEMENTI IN FERRO FORGIATO E CAPISALDI
FORGED BARS AND POSTS

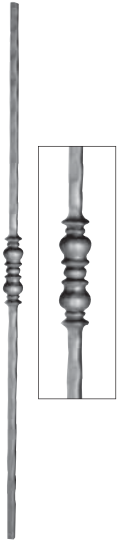

H.1000 mm.
Art. 11.019
□ 14 circa



H.1000 mm.
Art. 11.019.01
Ø 14 mm

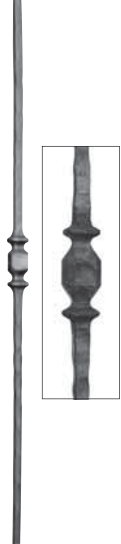

H.1000 mm.
Art. 11.020
□ 14 circa



H.1000 mm.
Art. 11.021
□ 14 circa



H.1000 mm.
Art. 11.021.01
□ 14 circa



H.1000 mm.
Art. 11.022
□ 14 circa



H. 1000 mm
Art. 11.023
14 mm circa



H.1000 mm.
Art. 11.023.01
□ 20 circa



H. 950 mm
Art. 11.023.02
Ø 14 mm



H. 950 mm
Art. 11.023.03
Ø 14 mm



H.1000 mm.
Art. 11.023.04
Ø 14 mm



H.1000 mm.
Art. 11.023.05
Ø 14 mm



H.1000 mm.
Art. 11.024
□ 14 circa



H.1000 mm.
Art. 11.025
□ 14 circa



H.1000 mm.
Art. 11.026



H.1000 mm.
Art. 11.027



H.1000 mm.
Art. 11.028



H.1000 mm.
Art. 11.029
□ 14 circa



H.1000 mm.
Art. 11.030
□ 14 circa



H.1000 mm.
Art. 11.031
□ 14 circa



H.1000 mm.
Art. 11.032
□ 14 circa



H.1000 mm.
Art. 11.033
□ 14 circa



H.1000 mm.
Art. 11.034
□ 14 circa



H.1000 mm.
Art. 11.035
□ 14 circa

Tutte le parti di questo catalogo - foto comprese - sono di proprietà Euro-Fer. La riproduzione, anche parziale, è vietata in ogni forma e con ogni mezzo. / Every part of this catalogue - photos included - is Euro-Fer's property. All forms of copying are strictly prohibited.

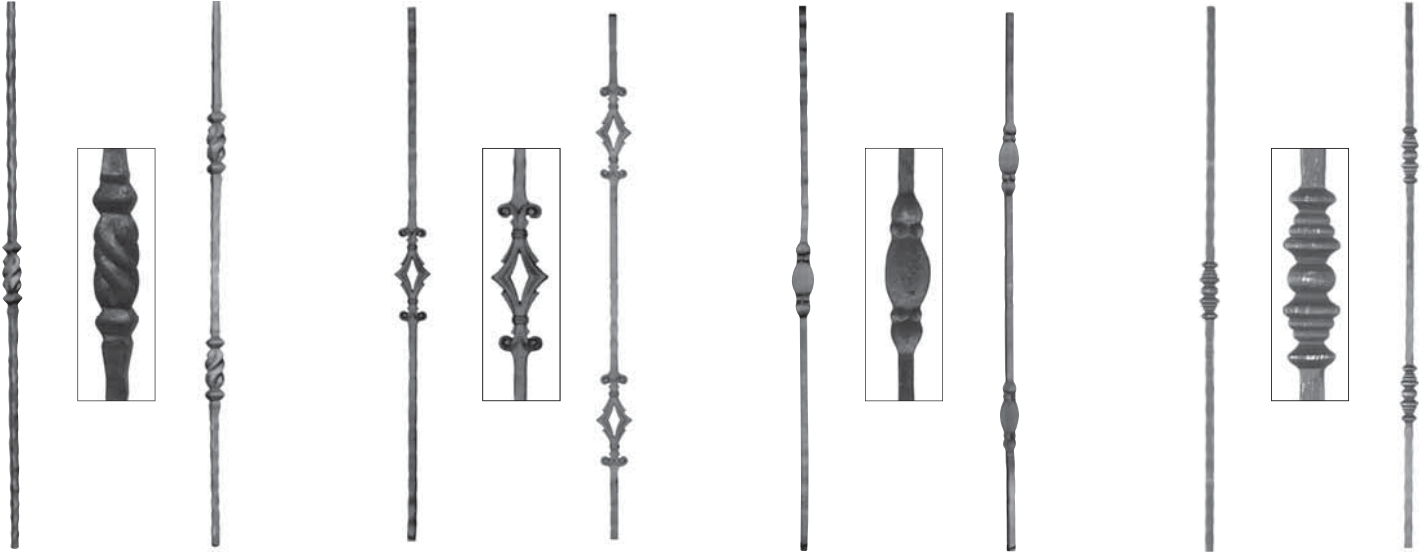

H.1000 mm. Art. 11.036 □ 14 circa
 H.1000 mm. Art. 11.037 □ 14 circa
 H.1000 mm. Art. 11.038 □ 14 circa
 H.1000 mm. Art. 11.039 □ 14 circa
 H.1000 mm. Art. 11.040 □ 12 circa
 H.1000 mm. Art. 11.041 □ 12 circa
 H.1000 mm. Art. 11.041.02 □ 14 circa
 H.1000 mm. Art. 11.041.03 □ 14 circa

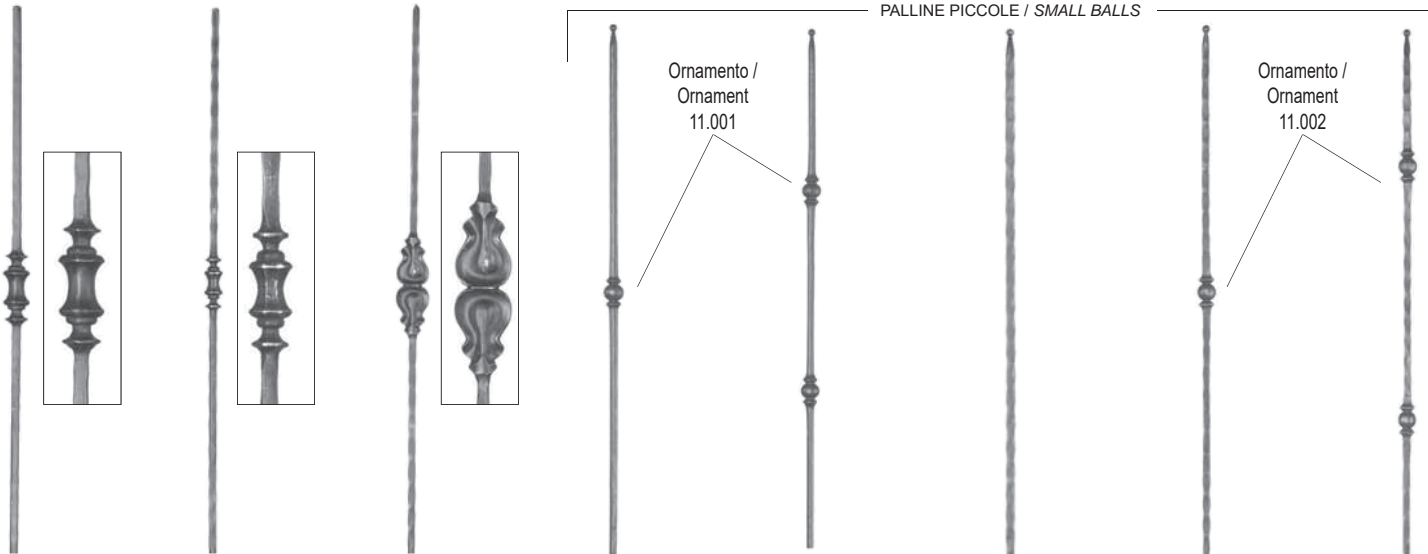

H.1000 mm. Art. 11.041.04 □ 14 circa
 H.1000 mm. Art. 11.041.05 □ 12 circa
 H.1000 mm. Art. 11.041.06 □ 12 circa
 Tondo / Round H.1000 mm. Art. 11.041.07 Ø 14 circa
 Tondo / Round H.1000 mm. Art. 11.041.08 Ø 14 circa
 H.1000 mm. Art. 11.041.09 □ 14 circa
 H.1000 mm. Art. 11.041.10 □ 14 circa
 H.1000 mm. Art. 11.041.11 □ 14 circa

PALLINE PICCOLE / SMALL BALLS

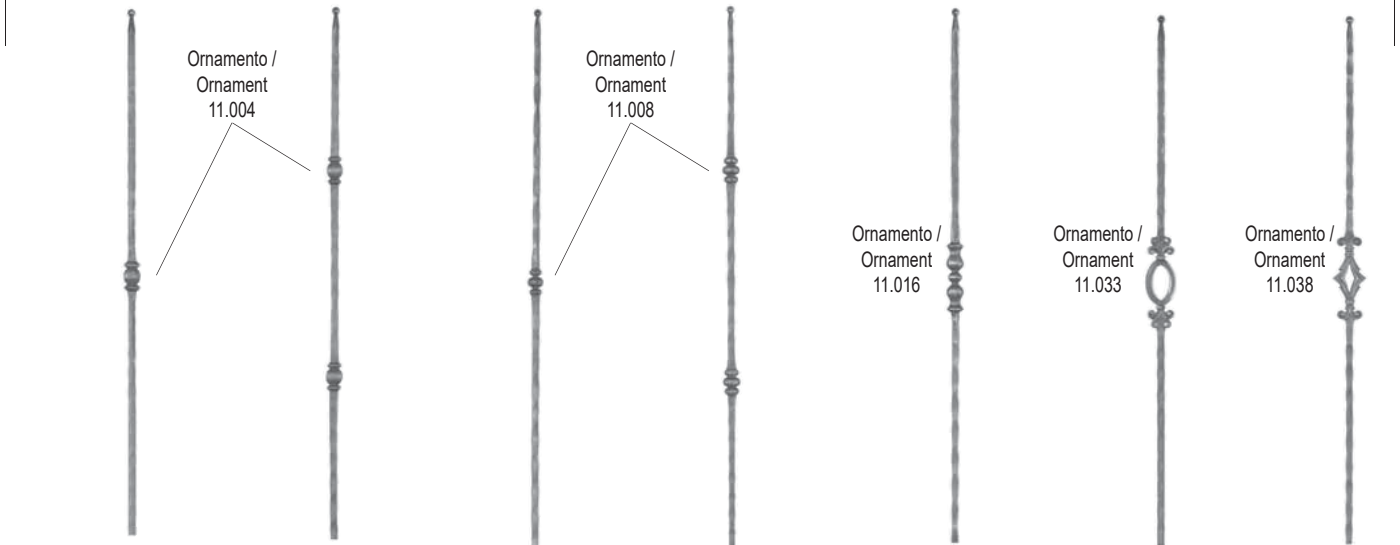

H.1000 mm. Art. 11.041.12 □ 14 circa
 H.1000 mm. Art. 11.041.13 □ 14 circa
 H.1000 mm. Art. 11.041.14 □ 14 circa
 H.1000 mm. Art. 11.041.15 □ 14 circa
 H.1000 mm. Art. 11.041.17 □ 14 circa
 H.1000 mm. Art. 11.041.18 □ 14 circa
 H.1000 mm. Art. 11.041.19 □ 14 circa

Tutte le parti di questo catalogo - foto comprese - sono di proprietà Euro-Fer. La riproduzione, anche parziale, è vietata in ogni forma e con ogni mezzo. / Every part of this catalogue - photos included - is Euro-Fer's property. All forms of copying are strictly prohibited.



PALLINE PICCOLE / SMALL BALLS

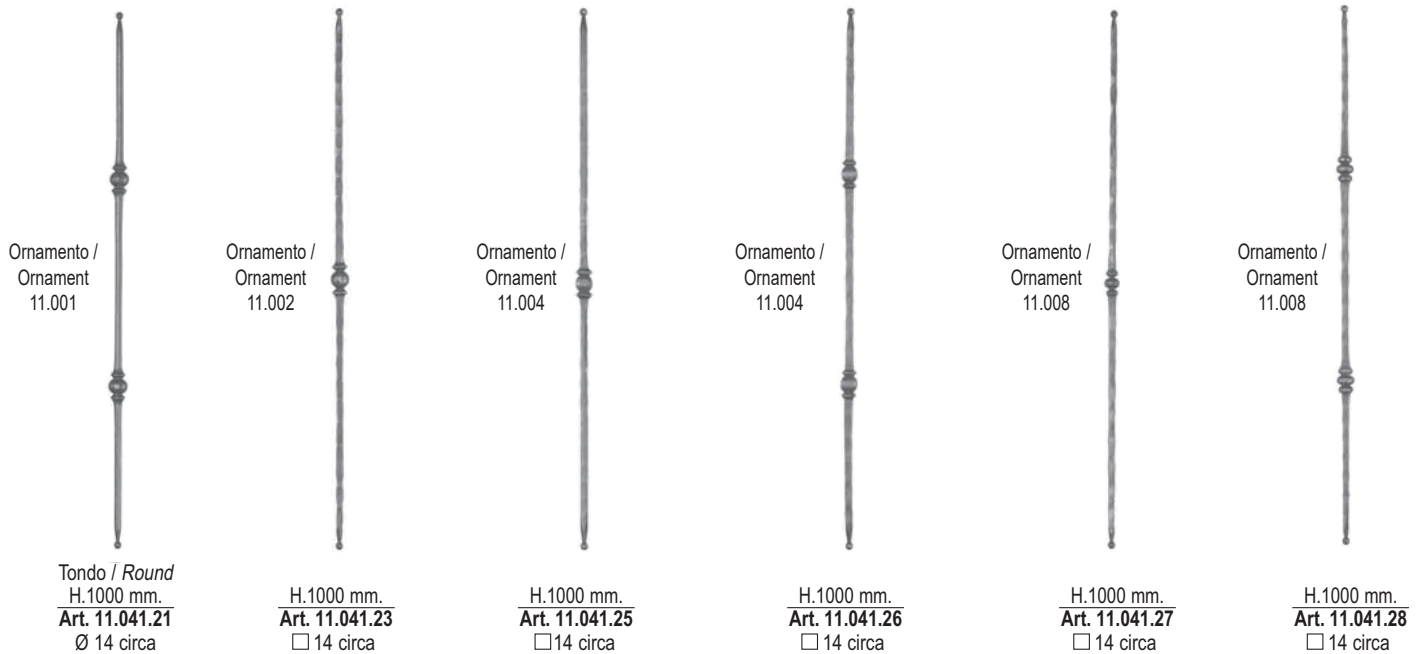

PALLINE PICCOLE / SMALL BALLS

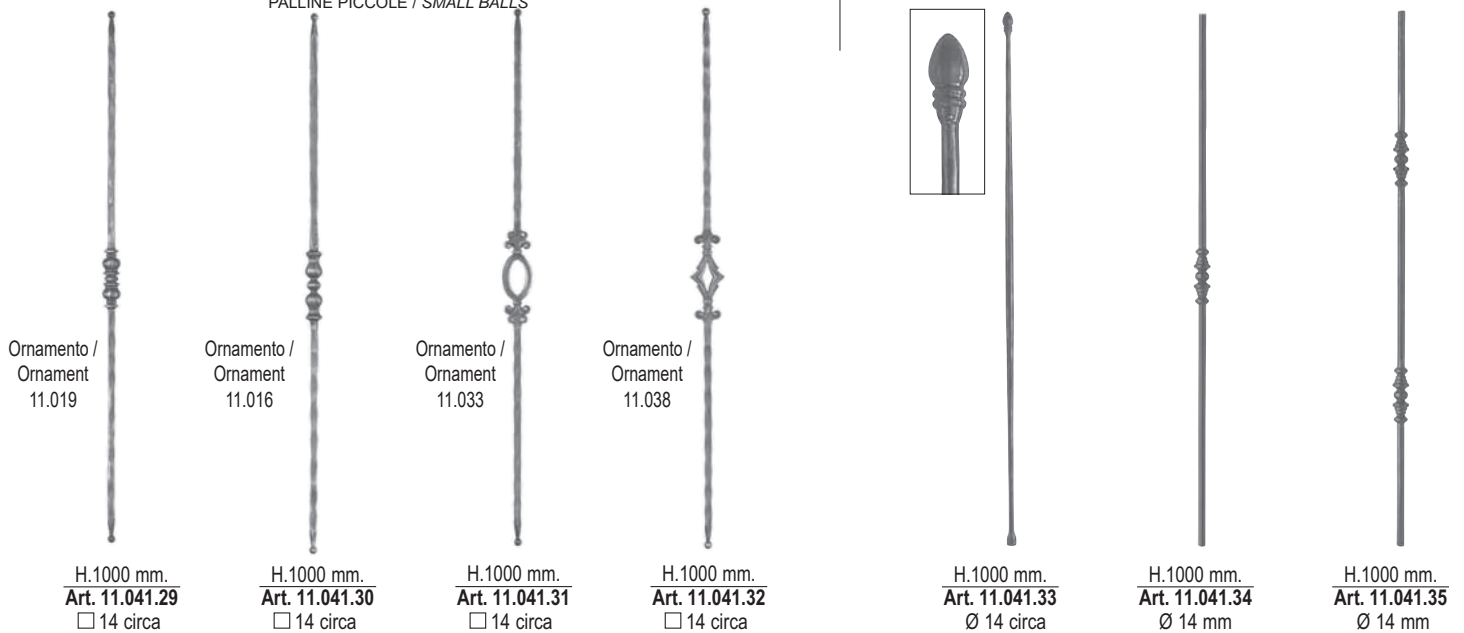

Tutte le parti di questo catalogo - foto comprese - sono di proprietà Euro-Fer. La riproduzione, anche parziale, è vietata in ogni forma e con ogni mezzo. / Every part of this catalogue - photos included - is Euro-Fer's property. All forms of copying are strictly prohibited.



H.1000 mm.
Art. 11.041.36
Ø 12 mm



H.1000 mm.
Art. 11.041.37
Ø 12 mm



H.1000 mm.
Art. 11.041.38
□ 14 circa



H. 1000 mm
Art. 11.041.39
Ø 12 mm



H.1000 mm.
Art. 11.041.40
□ 14 mm



H. 1000 mm
Art. 11.041.41
□ 14 mm



H.1000 mm.
Art. 11.041.42
Ø 14 mm circa



H.1000 mm.
Art. 11.041.43
Ø 14 mm circa

450



H.1000 mm.
Art. 11.041.44
Ø 14 mm circa



400

H.1000 mm.
Art. 11.041.45
Ø 14 mm circa



H.1000 mm.
Art. 11.041.46
□ 14 mm circa



H.1000 mm.
Art. 11.041.47
Ø 14 mm circa



H.1000 mm.
Art. 11.041.48
Ø 14 mm circa



310

H.1000 mm.
Art. 11.041.49
Ø 14 mm circa



310

H.1000 mm.
Art. 11.041.50
Ø 14 mm circa



310

H.1000 mm.
Art. 11.041.51
Ø 14 mm circa



H.1000 mm
Art. 11.041.52
□ 12 mm ca.



360

H.1000 mm
Art. 11.041.53
□ 12 mm ca.



H.1000 mm
Art. 11.041.54
Ø 12 mm ca.



490

H.1000 mm
Art. 11.041.55
Ø 12 mm ca.



H.1000 mm
Art. 11.041.68 Ø 12 ca.
Art. 11.041.69 Ø 14 ca.



Smussato / Blunted

H.1000 mm
Art. 11.041.70
□ 14 mm ca.



Smussato / Blunted

400

H.1000 mm
Art. 11.041.71
□ 14 mm ca.



Tutte le parti di questo catalogo - foto comprese - sono di proprietà Euro-Fer. La riproduzione, anche parziale, è vietata in ogni forma e con ogni mezzo. / Every part of this catalogue - photos included - is Euro-Fer's property. All forms of copying are strictly prohibited.

**ELEMENTI IN FERRO FORGIATO E CAPISALDI
FORGED BARS AND POSTS**



H.1000 mm
Art. 11.041.72
□ 12 mm ca.

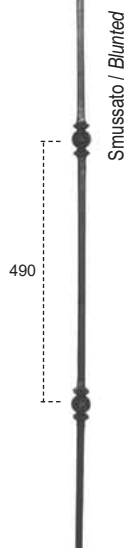

H.1000 mm
Art. 11.041.73
□ 12 mm ca.



H.1000 x L.120 mm
Art. 11.041.79
□ 14 mm ca.



H.1000 X L.135 mm
Art. 11.041.80
Ø 14 mm



H.1000 X L.135 mm
Art. 11.041.81
Ø 14 mm

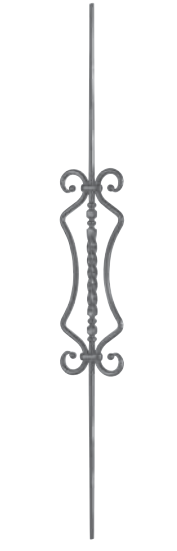

H.1000 X L.135 mm.
Art. 11.041.82
Ø 14 mm

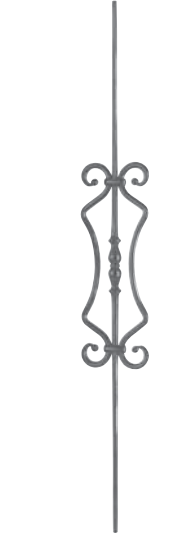

H.1000 X L.135 mm.
Art. 11.041.83
Ø 12 mm



H.1000 X L.125 mm.
Art. 11.041.84
□ 14 mm circa



H.1000 X L.125 mm.
Art. 11.041.85
Ø 14 mm circa



H.1000 X L.125 mm.
Art. 11.041.86
□ 14 mm circa

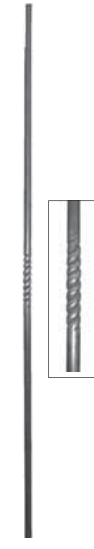

Liscio / Smooth
H. 1000 mm
Art. 11.041.100 Ø 12 c.a.



Liscio / Smooth
H.1000 mm
Art. 11.041.104 Ø14 ca.



Liscio / Smooth
H.1000 mm
Art. 11.041.105 Ø14 ca.



Forgiato / Forged
H. 1000 mm
Art. 11.041.108 Ø 12 c.a.



Forgiato / Forged
H.1000 mm
Art. 11.041.109 Ø 12 ca.



Forgiato / Forged
H.1000 mm
Art. 11.041.110 Ø 12 ca.



Forgiato / Forged
H.1000 mm
Art. 11.041.111 Ø12 ca.



Forgiato / Forged
H.1000 mm
Art. 11.041.113 Ø12 ca.

Tutte le parti di questo catalogo - foto comprese - sono di proprietà Euro-Fer. La riproduzione, anche parziale, è vietata in ogni forma e con ogni mezzo. / Every part of this catalogue - photos included - is Euro-Fer's property. All forms of copying are strictly prohibited.



Forgiato / Forged
H.1000 mm
Art. 11.041.115 Ø14
circa



Smussato / Blunted
H.1000 mm
Art. 11.041.118 □13 ca



Battuto / Beaten
H.1100 mm.
Art. 11.042 □ 20
Art. 11.043 □ 25
Art. 11.044 □ 30



H.1100 mm.
Art. 11.044.01 □ 20
Art. 11.044.02 □ 25
Art. 11.044.03 □ 30



H.1100 mm.
Art. 11.044.04 □ 20
Art. 11.044.05 □ 25
Art. 11.044.06 □ 30



H.1200 mm.
Art. 11.044.07 □ 20
Art. 11.044.08 □ 25
Art. 11.044.09 □ 30



In Spigolo / Edged Bar
H.1200 mm.
Art. 11.045 □ 25
Art. 11.046 □ 30



H.1100 mm.
Art. 11.047 □ 20
Art. 11.048 □ 25
Art. 11.049 □ 30



Martellato / Hammered
H.1100 mm.
Art. 11.049.01 □ 20
Art. 11.049.02 □ 25
Art. 11.049.03 □ 30



Liscio / Smooth
H.1200 mm
Art. 11.049.08
Ø 25 circa

Fuori Produzione
Out of Production



Forgiato / Forged
H. 1200 mm
Art. 11.049.11
□ 25 mm

Fuori Produzione
Out of Production



Forgiato / Forged
H. 1200 mm
Art. 11.049.12
Ø 25 mm



In Spigolo / Edged Bar
H.1200 mm.
Art. 11.050 □ 25
Art. 11.051 □ 30



Martellato / Hammered
H.1100 mm.
Art. 11.052 □ 20
Art. 11.052.01 □ 25
Art. 11.052.02 □ 30



H.1100 mm.
Art. 11.053 □ 20
Art. 11.053.01 □ 25
Art. 11.053.02 □ 30



H.1200 mm.
Art. 11.053.03 □ 25
Art. 11.053.04 □ 30



H.1200 mm.
Art. 11.053.05 □ 25
Art. 11.053.06 □ 30

Tutte le parti di questo catalogo - foto comprese - sono di proprietà Euro-Fer. La riproduzione, anche parziale, è vietata in ogni forma e con ogni mezzo. / Every part of this catalogue - photos included - is Euro-Fer's property. All forms of copying are strictly prohibited.



Martellato / Hammered
H.1200 mm.
Art. 11.053.07 □ 25
Art. 11.053.08 □ 30

Tondo / Round
H.1200 mm.
Art. 11.053.09 Ø 25
Art. 11.053.10 Ø 30

H.1200 mm.
Art. 11.053.11 □ 25
Art. 11.053.12 □ 30

Martellato / Hammered
H.1200 mm.
Art. 11.053.13 □ 25
Art. 11.053.14 □ 30

Tondo / Round
H.1200 mm.
Art. 11.053.15 Ø 25
Art. 11.053.16 Ø 30

H.1200 mm.
Art. 11.053.17 □ 20
Art. 11.053.18 □ 25
Art. 11.053.19 □ 30

Martellato / Hammered
H.1200 mm.
Art. 11.053.20 □ 20
Art. 11.053.21 □ 25
Art. 11.053.22 □ 30

Tondo / Round
H.1200 mm.
Art. 11.053.23 Ø 25
Art. 11.053.24 Ø 30

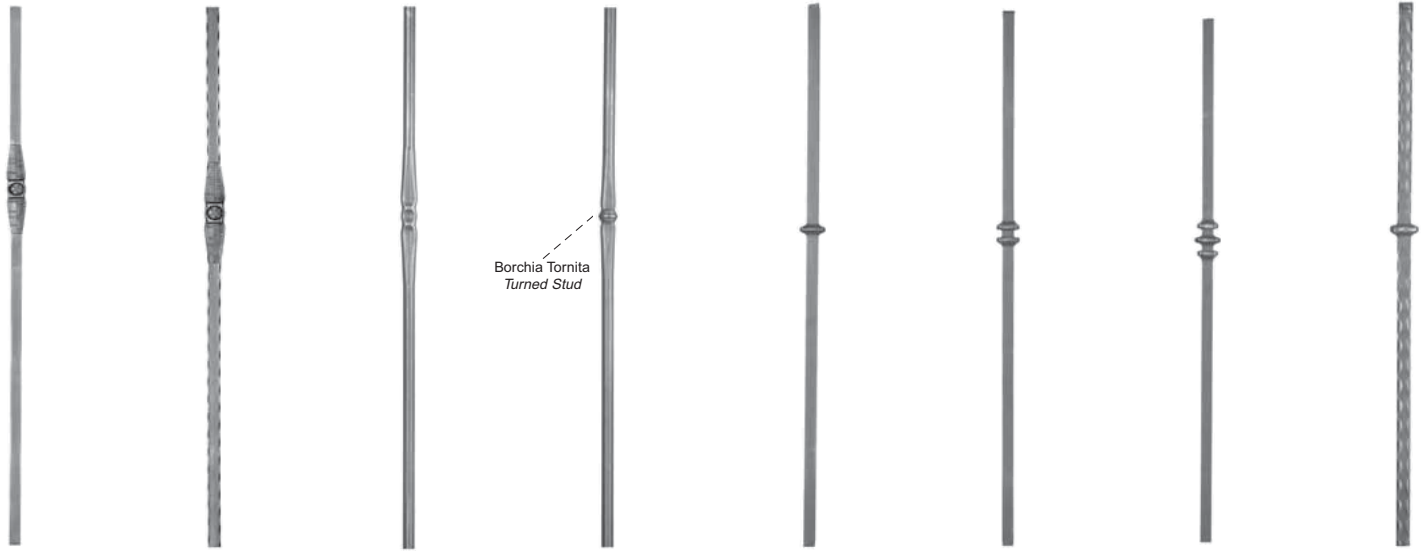

Borchia Tornita
Turned Stud

H.1200 mm.
Art. 11.053.25 □ 25
Art. 11.053.26 □ 30

Martellato / Hammered
H.1200 mm.
Art. 11.053.27 □ 25
Art. 11.053.28 □ 30

Tondo / Round
H.1200 mm.
Art. 11.053.29 Ø 25

Tondo / Round
H.1200 mm.
Art. 11.053.30 Ø 25

H.1200 mm.
Art. 11.053.31 □ 25
Art. 11.053.32 □ 30

H.1200 mm.
Art. 11.053.33 □ 25
Art. 11.053.34 □ 30

H.1200 mm.
Art. 11.053.35 □ 25
Art. 11.053.36 □ 30

Martellato / Hammered
H.1200 mm.
Art. 11.053.37 □ 25
Art. 11.053.38 □ 30



Martellato / Hammered
H.1200 mm.
Art. 11.053.39 □ 25
Art. 11.053.40 □ 30

Martellato / Hammered
H.1200 mm.
Art. 11.053.41 □ 25
Art. 11.053.42 □ 30

Tondo / Round
H.1200 mm.
Art. 11.053.43 Ø 25
Art. 11.053.44 Ø 30

Tondo / Round
H.1200 mm.
Art. 11.053.45 Ø 25
Art. 11.053.46 Ø 30

Tondo / Round
H.1200 mm.
Art. 11.053.47 Ø 25
Art. 11.053.48 Ø 30

H.1200 mm.
Art. 11.053.49 □ 25
Art. 11.053.50 □ 30

Martellato / Hammered
H.1200 mm.
Art. 11.053.51 □ 25
Art. 11.053.52 □ 30

Tondo / Round
H.1200 mm.
Art. 11.053.53 Ø 25
Art. 11.053.54 Ø 30

Tutte le parti di questo catalogo - foto comprese - sono di proprietà Euro-Fer. La riproduzione, anche parziale, è vietata in ogni forma e con ogni mezzo. / Every part of this catalogue - photos included - is Euro-Fer's property. All forms of copying are strictly prohibited.

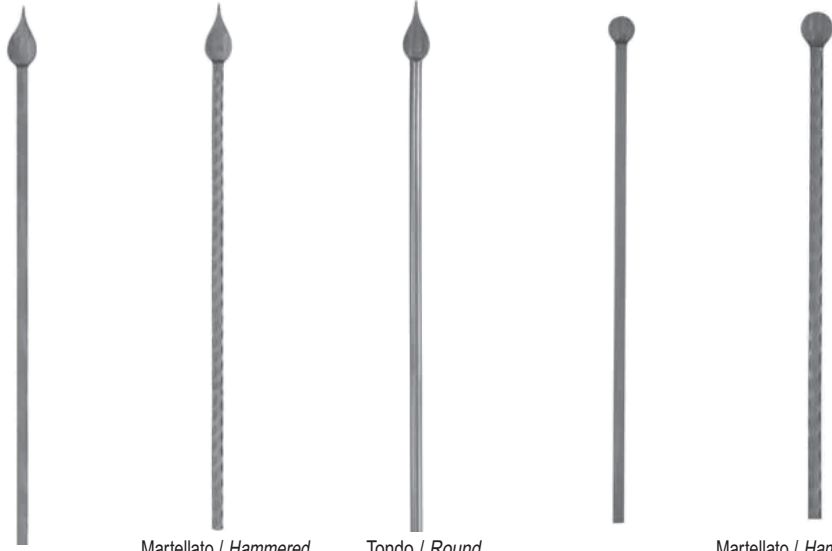

H.1200 mm.
Art. 11.053.55 □ 25
Art. 11.053.56 □ 30

Martellato / *Hammered*
H.1200 mm.
Art. 11.053.57 □ 25
Art. 11.053.58 □ 30

Tondo / *Round*
H.1200 mm.
Art. 11.053.59 Ø 25
Art. 11.053.60 Ø 30

H.1200 mm.
Art. 11.053.61 □ 25
Art. 11.053.62 □ 30

Martellato / *Hammered*
H.1200 mm.
Art. 11.053.63 □ 25
Art. 11.053.64 □ 30

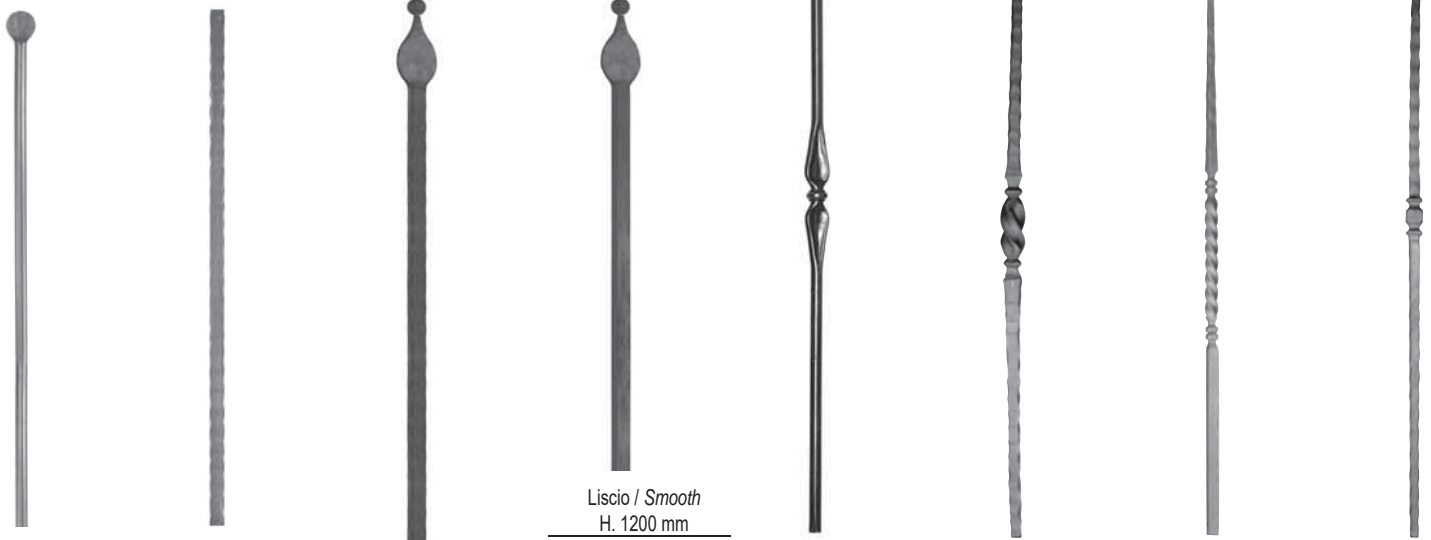
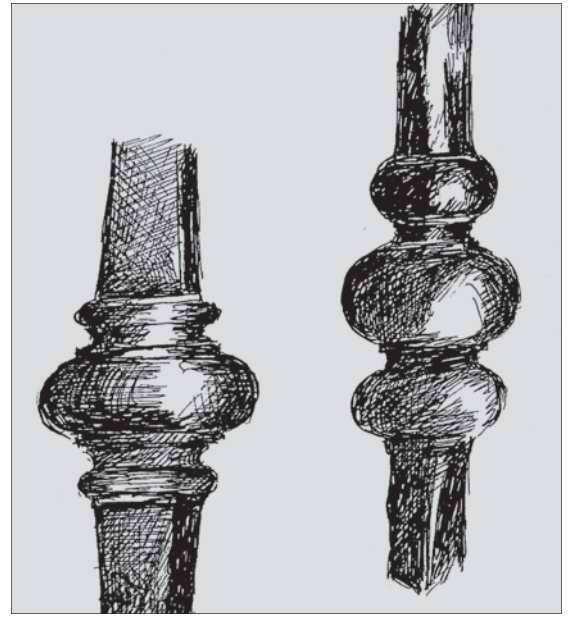

Tondo / *Round*
H.1200 mm.
Art. 11.053.65 Ø 25
Art. 11.053.66 Ø 30

Martellato / *Hammered*
H.1200 mm.
Art. 11.053.67 □ 25 circa
Art. 11.053.68 □ 30 circa

H. 1200 mm
Martellato / *Hammered*
Art. 11.053.69 □ 30x30
Art. 11.053.70 □ 25x25

Liscio / *Smooth*
H. 1200 mm
Art. 11.053.71 □ 30x30
Art. 11.053.72 □ 25x25
Art. 11.053.73 Ø 30
Art. 11.053.74 Ø 25

Liscio / *Smooth*
H.1200 mm
Art. 11.053.90
Ø 25 circa

H.1200 mm.
Art. 11.054
□ 25 circa

H.1200 mm.
Art. 11.055
□ 25 circa

H.1200 mm.
Art. 11.056
□ 25 circa



H.1200 mm.
Art. 11.057 □ 25 circa
Art. 11.058 □ 30 circa

H.1200 mm.
Art. 11.059 □ 25 circa
Art. 11.060 □ 30 circa

H.1200 mm.
Art. 11.059.P
□ 25 circa

H.1200 mm.
Art. 11.061 □ 25 circa
Art. 11.062 □ 30 circa

H.1200 mm.
Art. 11.063
□ 25 circa

H.1200 mm.
Art. 11.064
□ 25 circa

H.1200 mm.
Art. 11.065
□ 25 circa

H.1200 mm.
Art. 11.066
□ 25 circa

Tutte le parti di questo catalogo - foto comprese - sono di proprietà Euro-Fer. La riproduzione, anche parziale, è vietata in ogni forma e con ogni mezzo. / Every part of this catalogue - photos included - is Euro-Fer's property. All forms of copying are strictly prohibited.

ELEMENTI IN FERRO FORGIATO E CAPISALDI
FORGED BARS AND POSTS



H.1200 mm.
Art. 11.067
□ 25 circa



H.1200 mm
Art. 11.067.01
Ø 25 circa



FIGURA IN TONDO
ROUND MOTIF

H.1200 mm.
Art. 11.068
Ø 25 mm



FIGURA IN QUADRO
SQUARE MOTIF

H.1200 mm.
Art. 11.068.01
Ø 25 mm



H.1200 mm.
Art. 11.069
Ø 30 circa



H.1200 mm.
Art. 11.070
□ 25 mm



Smussato / Blunted
H.1200 mm
Art. 11.070.01
□ 25 mm ca.



H.1200 mm.
Art. 11.071
□ 25 mm



Forgiato / Forged
H.1200 mm
Art. 11.071.01
□ 25 circa



H.1200 mm.
Art. 11.072
Ø 25 mm



H.1200 mm.
Art. 11.073
□ 25 mm



Martellato / Hammered
H.1200 mm.
Art. 11.074
□ 25 mm



Liscio / Smooth
H.1200 mm.
Art. 11.075
Ø 25 mm

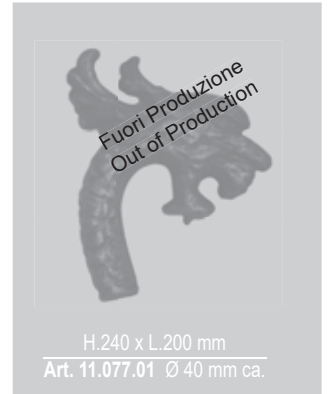

H.240 x L.200 mm
Art. 11.077.01 Ø 40 mm ca.



Tondo Lavorato / Round Hammered
H.1100 X L.400 mm.
Art. 11.077
Ø 30 mm



H.870 X L.480 mm.
Art. 11.078



H.970 X L.420 mm.
Art. 11.079



H.1100 x L.480 mm
Art. 11.080

Tutte le parti di questo catalogo - foto comprese - sono di proprietà Euro-Fer. La riproduzione, anche parziale, è vietata in ogni forma e con ogni mezzo. / Every part of this catalogue - photos included - is Euro-Fer's property. All forms of copying are strictly prohibited.



H.160 mm.
Art. 11.100
□ 14 mm circa

H.160 mm.
Art. 11.101
□ 14 mm circa

H.160 mm.
Art. 11.102
Ø 12 mm circa

H.200 mm.
Art. 11.150
□ 24 mm circa

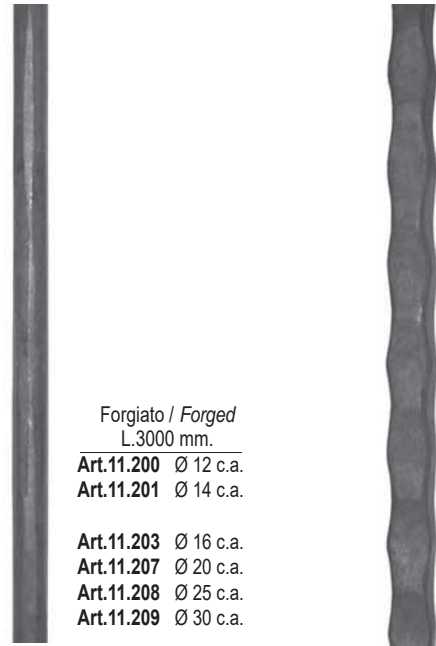

Forgiato / Forged
L.3000 mm.
Art.11.200 Ø 12 c.a.
Art.11.201 Ø 14 c.a.

Art.11.203 Ø 16 c.a.
Art.11.207 Ø 20 c.a.
Art.11.208 Ø 25 c.a.
Art.11.209 Ø 30 c.a.

Forgiato / Forged
L.3000 mm.
Art.11.210 □ 12 c.a.
Art.11.211 □ 14 c.a.



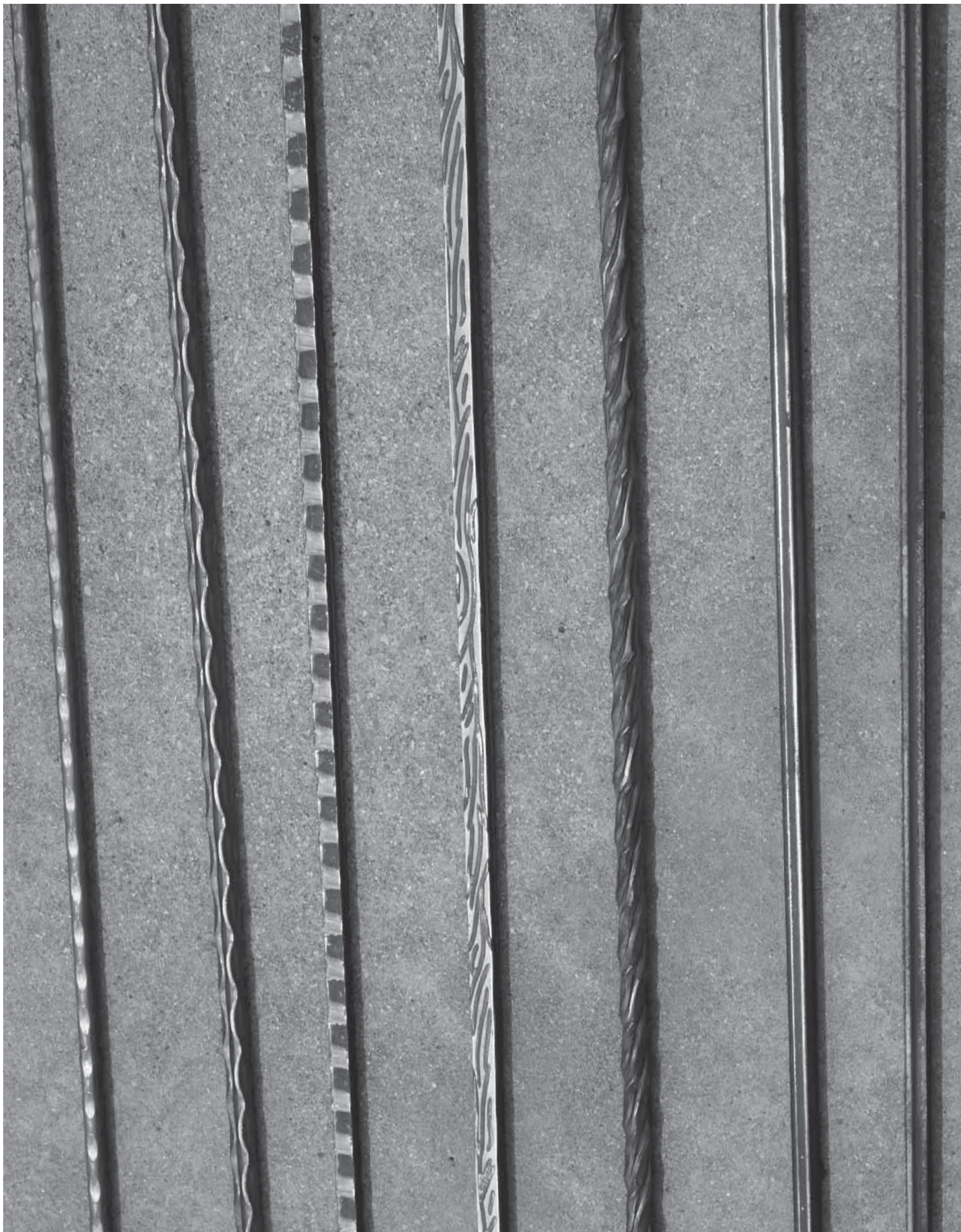

Tutte le parti di questo catalogo - foto comprese - sono di proprietà Euro-Fer. La riproduzione, anche parziale, è vietata in ogni forma e con ogni mezzo. / Every part of this catalogue - photos included - is Euro-Fer's property. All forms of copying are strictly prohibited.

H.3000 mm.

Art. 12.001	≠	25 X 6
Art. 12.002	≠	25 X 8
Art. 12.003	≠	30 X 6
Art. 12.004	≠	30 X 8
Art. 12.004.01	≠	35 X 8
Art. 12.005	≠	40 X 8
Art. 12.006	≠	50 X 10
Art. 12.006.01	≠	20 X 5
Art. 12.006.02	≠	20 X 6
Art. 12.006.03	≠	20 X 8
Art. 12.006.04	≠	25 X 10
Art. 12.006.05	≠	25 X 12
Art. 12.006.06	≠	30 X 4
Art. 12.006.07	≠	30 X 10
Art. 12.006.08	≠	30 X 12
Art. 12.006.09	≠	35 X 10
Art. 12.006.10	≠	40 X 6
Art. 12.006.11	≠	40 X 10
Art. 12.006.12	≠	50 X 8
Art. 12.006.13	≠	100 X 10
Art. 12.006.14	≠	100 X 8
Art. 12.006.15	≠	100 X 6
Art. 12.006.16	≠	70 X 6
Art. 12.006.17	≠	50 X 6
Art. 12.006.18	≠	60 X 6



H.6000 mm.

Art. 12.007	≠	25 X 6
Art. 12.008	≠	25 X 8
Art. 12.009	≠	30 X 6
Art. 12.010	≠	30 X 8
Art. 12.010.01	≠	35 X 8
Art. 12.011	≠	40 X 8
Art. 12.012	≠	50 X 10
Art. 12.012.01	≠	20 X 5
Art. 12.012.02	≠	20 X 6
Art. 12.012.03	≠	20 X 8
Art. 12.012.04	≠	25 X 10
Art. 12.012.05	≠	25 X 12
Art. 12.012.06	≠	30 X 4
Art. 12.012.07	≠	30 X 10
Art. 12.012.08	≠	30 X 12
Art. 12.012.09	≠	35 X 10
Art. 12.012.10	≠	40 X 6
Art. 12.012.11	≠	40 X 10
Art. 12.012.12	≠	50 X 8
Art. 12.012.13	≠	100 X 10
Art. 12.012.14	≠	100 X 8
Art. 12.012.15	≠	100 X 6
Art. 12.012.16	≠	70 X 6
Art. 12.012.17	≠	50 X 6
Art. 12.012.18	≠	60 X 6



H.400 X L.100 mm.

Art. 12.013	≠	40 X 8
Art. 12.014	≠	50 X 10
Art. 12.014.01	≠	50 X 8

H.400 X L.130 mm.

Art. 12.015	≠	40 X 8
Art. 12.016	≠	50 X 10
Art. 12.016.01	≠	50 X 8

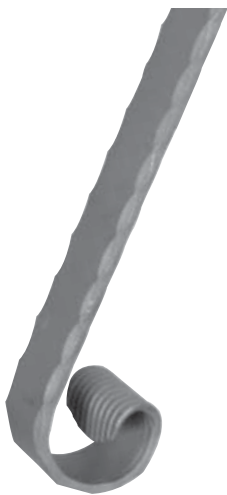

H.400 X L.100 mm.

Art. 12.017	≠	40 X 8
Art. 12.018	≠	50 X 10

H.400 X L.180 mm.

Art. 12.018.01	≠	40 X 8
----------------	---	--------

H.450 mm.

Art. 12.019	≠	40 X 8
-------------	---	--------

H.460 mm.

Art. 12.020	≠	40 X 8
-------------	---	--------

H.680 X L.140 mm.

Art. 12.021	≠	40 X 8
Art. 12.022	≠	50 X 10
Art. 12.022.02	≠	50 X 8

H.840 X L.140 mm.

Art. 12.022.01	≠	40 X 8
Art. 12.022.03	≠	50 X 8

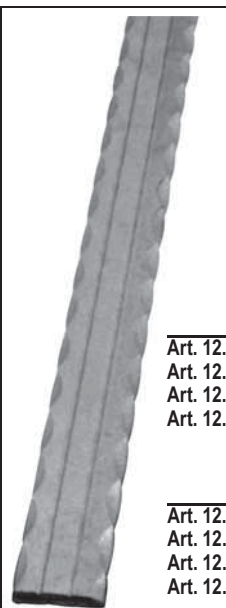

H.3000 mm.

Art. 12.029	≠	40 X 8
Art. 12.029.01	≠	50 X 10
Art. 12.029.02	≠	40 X 6
Art. 12.029.03	≠	30 X 8

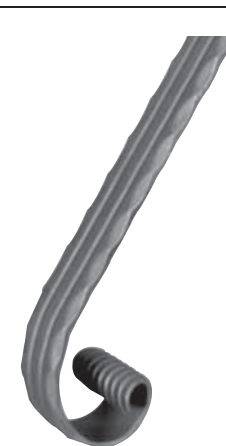

H.400 X L.400 mm.

Art. 12.023	≠	25 X 8
Art. 12.024	≠	30 X 8
Art. 12.025	≠	40 X 8
Art. 12.025.01	≠	35 X 8
Art. 12.025.02	≠	50 X 8

H.200 X L.200 mm.

Art. 12.026	≠	25 X 8 (mis. int. 130)
Art. 12.027	≠	30 X 8 (mis. int. 125)
Art. 12.028	≠	40 X 8 (mis. int. 120)

H.6000 mm.

Art. 12.030	≠	40 X 8
Art. 12.030.01	≠	50 X 10
Art. 12.030.02	≠	40 X 6
Art. 12.030.03	≠	30 X 8

H.460 mm.

Art. 12.031	≠	40 X 8
-------------	---	--------

H.400 X L.100 mm.

Art. 12.032	≠	40 X 8
Art. 12.032.02	≠	50 X 10

Tutte le parti di questo catalogo - foto comprese - sono di proprietà Euro-Fer. La riproduzione, anche parziale, è vietata in ogni forma e con ogni mezzo. / Every part of this catalogue - photos included - is Euro-Fer's property. All forms of copying are strictly prohibited.



H.200 X L.200 mm.
Art. 12.036 ≙ 40 X 8 (mis. int. 120)



H.400 X L.180 mm.
Art. 12.032.01 ≙ 40 X 8
Art. 12.032.03 ≙ 50 X 10

H.450 mm.
Art. 12.033 ≙ 40 X 8

H.680 X L.140 mm.
Art. 12.034 ≙ 40 X 8
Art. 12.034.03 ≙ 50 X 10

H.840 X L.140 mm.
Art. 12.034.01 ≙ 40 X 8
Art. 12.034.04 ≙ 50 X 10

H.720 X L.250 mm.
Art. 12.034.02 ≙ 40 X 8

H.400 X L.400 mm.
Art. 12.035 ≙ 40 X 8
Art. 12.035.01 ≙ 50 X 10



H.400 X L.180 mm.
Art. 12.040.01 ≙ 40 X 8

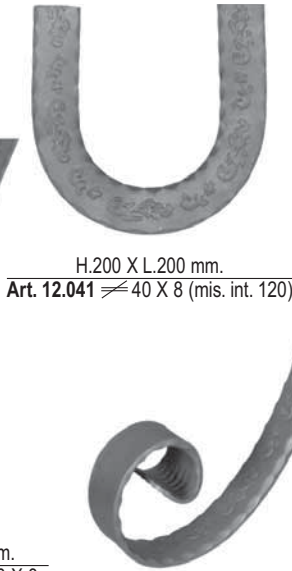

H.200 X L.200 mm.
Art. 12.041 ≙ 40 X 8 (mis. int. 120)

H.3000 mm.
Art. 12.037 ≙ 40 X 4
Art. 12.038 ≙ 40 X 8

H.6000 mm.
Art. 12.039 ≙ 40 X 4
Art. 12.040 ≙ 40 X 8

H.830 X L.140 mm.
Art. 12.042 ≙ 40 X 8



H.400 X L.100 mm.
Art. 12.042.01 ≙ 40 X 8



H.460 mm.
Art. 12.043 ≙ 40 X 8



H.680 mm.
Art. 12.043.01 ≙ 40 X 8



H.400 X L.400 mm.
Art. 12.044 ≙ 40 X 8



Dettaglio / Detail



CORRIMANO E PARTENZE HANDRAILS AND CORNERS

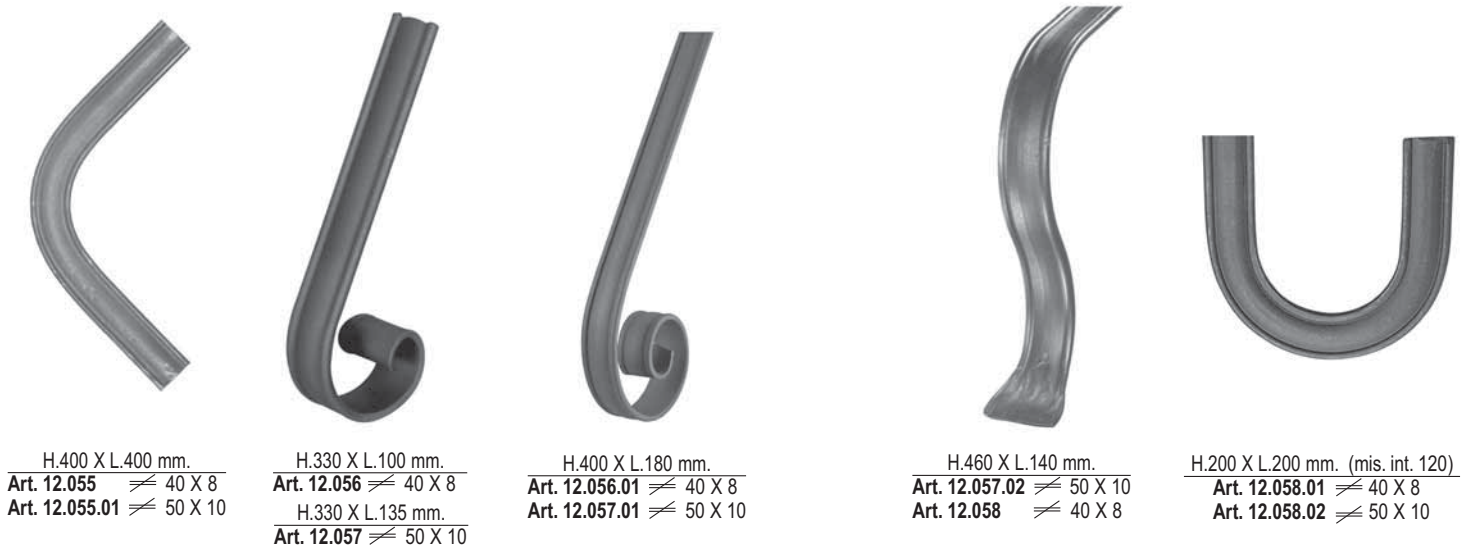
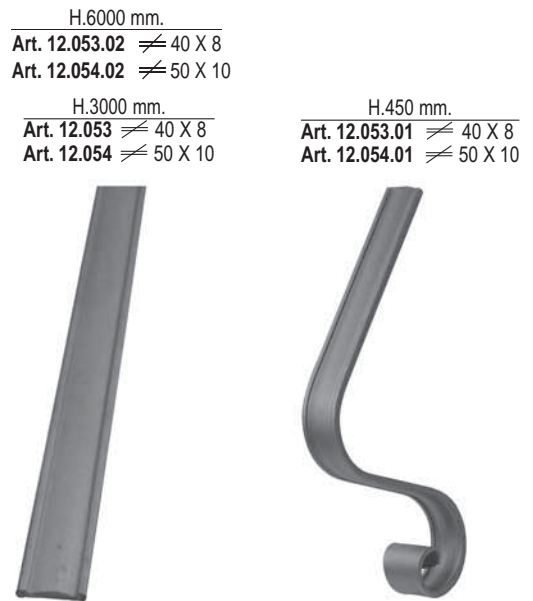
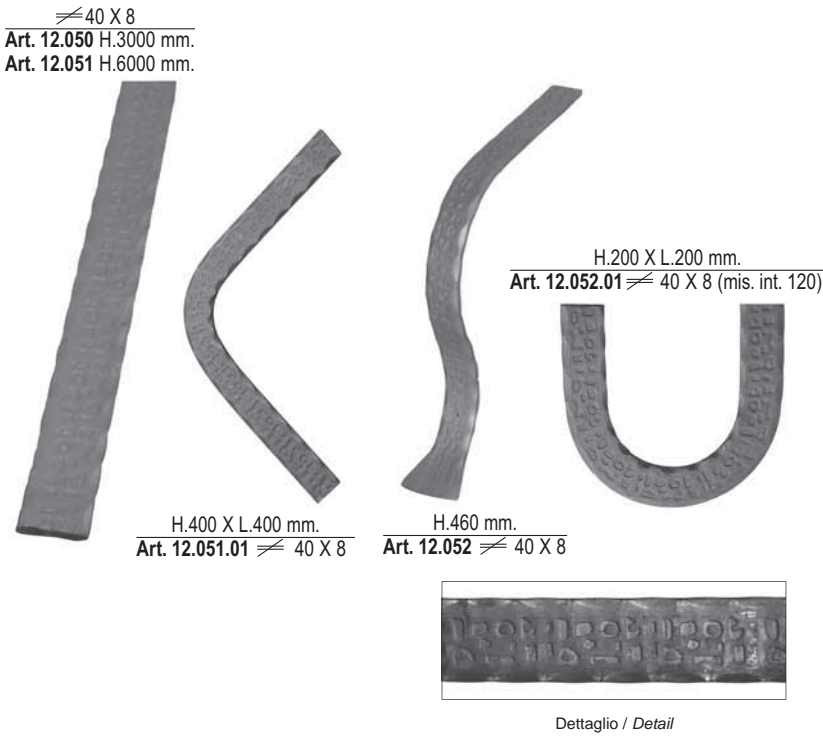
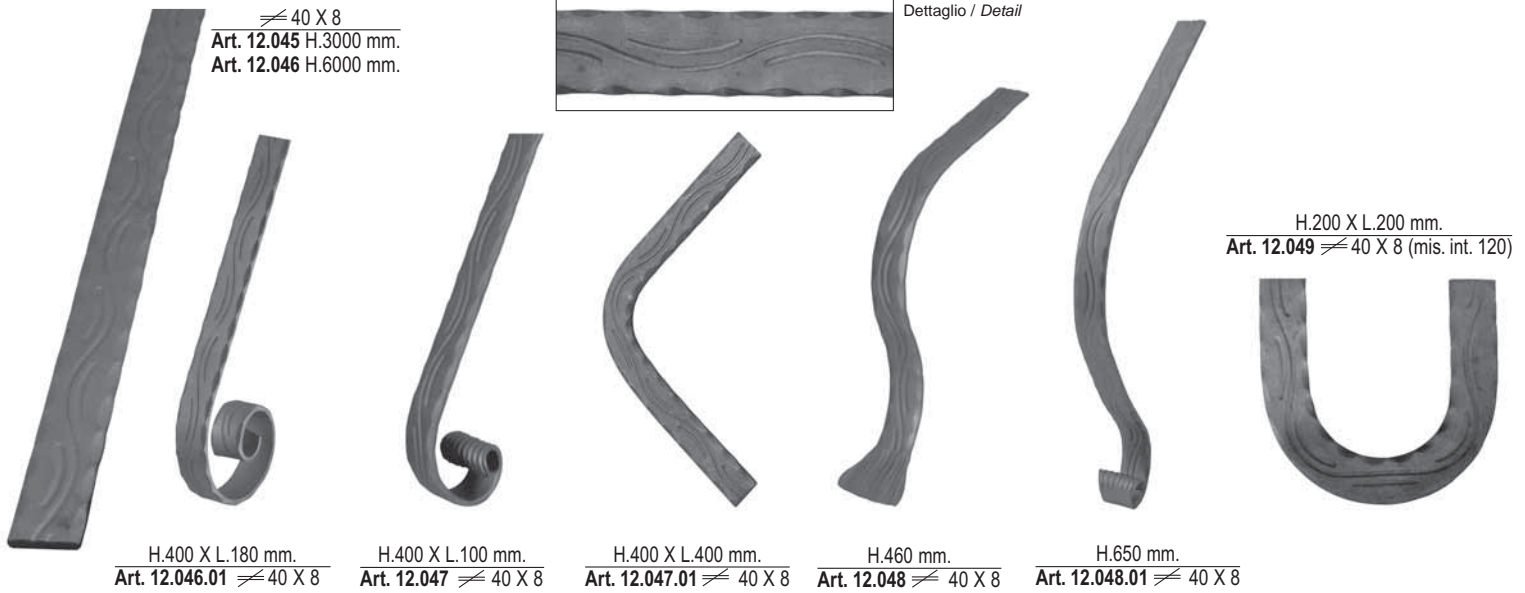

Tutte le parti di questo catalogo - foto comprese - sono di proprietà Euro-Fer. La riproduzione, anche parziale, è vietata in ogni forma e con ogni mezzo. / Every part of this catalogue - photos included - is Euro-Fer's property. All forms of copying are strictly prohibited.

CORRIMANO E PARTENZE HANDRAILS AND CORNERS

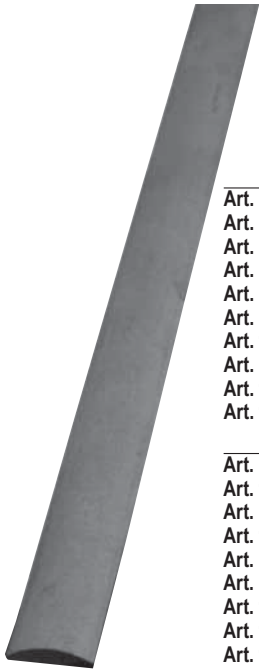

H.3000 mm.

Art. 12.059	≠ 30 X 8
Art. 12.059.02	≠ 25 X 7
Art. 12.060	≠ 30 X 10
Art. 12.061	≠ 35 X 8
Art. 12.062	≠ 35 X 10
Art. 12.063	≠ 40 X 8
Art. 12.064	≠ 40 X 10
Art. 12.065	≠ 40 X 12
Art. 12.066	≠ 50 X 10
Art. 12.067	≠ 50 X 12

H.6000 mm.

Art. 12.059.01	≠ 30 X 8
Art. 12.060.01	≠ 30 X 10
Art. 12.061.01	≠ 35 X 8
Art. 12.062.01	≠ 35 X 10
Art. 12.063.01	≠ 40 X 8
Art. 12.064.01	≠ 40 X 10
Art. 12.065.01	≠ 40 X 12
Art. 12.066.01	≠ 50 X 10
Art. 12.067.01	≠ 50 X 12



H.400 X L.400 mm.

Art. 12.067.02	≠ 30 X 8
Art. 12.067.03	≠ 30 X 10
Art. 12.067.04	≠ 35 X 8
Art. 12.067.05	≠ 35 X 10
Art. 12.067.06	≠ 40 X 8
Art. 12.067.07	≠ 40 X 10
Art. 12.067.08	≠ 40 X 12
Art. 12.067.09	≠ 50 X 10
Art. 12.067.10	≠ 50 X 12



H.400 X L.35 mm.

Art. 12.067.11	≠ 30 X 10
Art. 12.067.12	≠ 35 X 10
Art. 12.067.13	≠ 40 X 8
Art. 12.067.14	≠ 40 X 10
Art. 12.067.15	≠ 40 X 12
Art. 12.067.16	≠ 50 X 10
Art. 12.067.17	≠ 50 X 12



H.380 mm.

Art. 12.068	≠ 30 X 8
Art. 12.069	≠ 30 X 10
Art. 12.070	≠ 35 X 8
Art. 12.071	≠ 35 X 10
Art. 12.072	≠ 40 X 8
Art. 12.073	≠ 40 X 10
Art. 12.074	≠ 40 X 12
Art. 12.075	≠ 50 X 10
Art. 12.076	≠ 50 X 12



H.720 X L.250 mm.

Art. 12.076.01	≠ 30 X 10
Art. 12.076.02	≠ 35 X 10
Art. 12.076.03	≠ 40 X 8
Art. 12.076.04	≠ 40 X 10
Art. 12.076.05	≠ 40 X 12
Art. 12.076.06	≠ 50 X 10
Art. 12.076.07	≠ 50 X 12

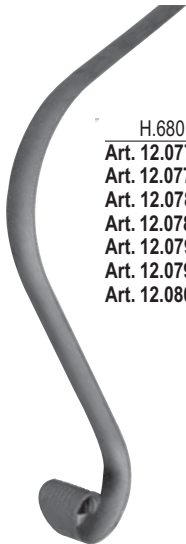

H.680 X L.270 mm.

Art. 12.077	≠ 30 X 10
Art. 12.077.01	≠ 35 X 10
Art. 12.078	≠ 40 X 8
Art. 12.078.01	≠ 40 X 10
Art. 12.079	≠ 40 X 12
Art. 12.079.01	≠ 50 X 12
Art. 12.080	≠ 50 X 10



H.200 X L.200 mm. (mis. int. 120)

Art. 12.080.01	≠ 30 X 8
Art. 12.080.02	≠ 40 X 8
Art. 12.080.03	≠ 50 X 10
Art. 12.080.04	≠ 40 X 10



≠ 40 X 8

Art. 12.081	H.3000 mm.
Art. 12.082	H.6000 mm.



H.380 X L.180 mm.

Art. 12.082.01	≠ 40 X 8
----------------	----------



H.400 X L.100 mm.

Art. 12.083	≠ 40 X 8
-------------	----------



H.400 X L.400 mm.
Art. 12.083.01 ≙ 50 X 14
Art. 12.083.02 ≙ 40 X 12
Art. 12.083.03 ≙ 45 X 12
Art. 12.083.04 ≙ 60 X 16



H.3000 mm.
Art. 12.084 ≙ 50 X 14
Art. 12.084.01 ≙ 40 X 12
Art. 12.084.02 ≙ 45 X 12
Art. 12.084.03 ≙ 60 X 16



H.400 mm.
Art. 12.086 ≙ 50 X 14
Art. 12.086.01 ≙ 40 X 12
Art. 12.086.02 ≙ 45 X 12
Art. 12.086.03 ≙ 60 X 16



H.300 X L.80 mm.
Art. 12.086.04 ≙ 50 X 14
Art. 12.086.05 ≙ 40 X 12
Art. 12.086.06 ≙ 45 X 12
Art. 12.086.07 ≙ 60 X 16



H.400 X L.35 mm.
Art. 12.086.08 ≙ 50 X 14
Art. 12.086.09 ≙ 40 X 12
Art. 12.086.10 ≙ 45 X 12
Art. 12.086.11 ≙ 60 X 16



H.100 X L.400 mm.
Art. 12.086.12 ≙ 50 X 14
Art. 12.086.13 ≙ 40 X 12
Art. 12.086.14 ≙ 45 X 12
Art. 12.086.15 ≙ 60 X 16



H.170 X L.400 mm.
Art. 12.087 ≙ 50 X 14
Art. 12.087.01 ≙ 40 X 12
Art. 12.087.02 ≙ 45 X 12
Art. 12.087.03 ≙ 60 X 16



H.680 mm.
Art. 12.087.04 ≙ 50 X 14
Art. 12.087.05 ≙ 40 X 12
Art. 12.087.06 ≙ 45 X 12
Art. 12.087.07 ≙ 60 X 16

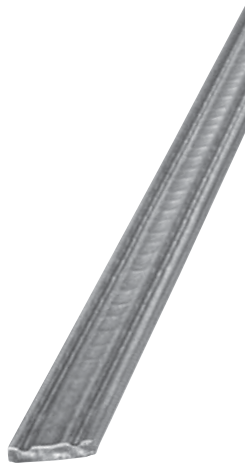
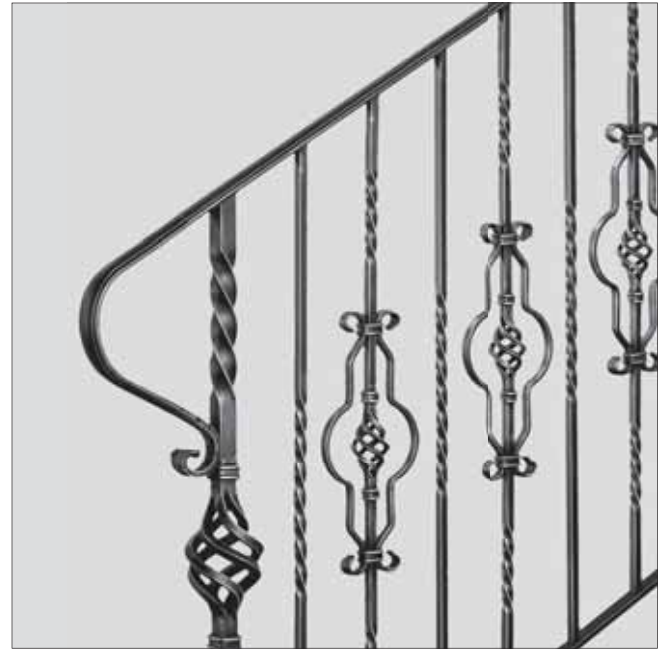

≙ 40 X 8
Art. 12.087.08 H.3000 mm.
Art. 12.087.09 H.6000 mm.



H.100 X L.400 mm.
Art. 12.087.10 ≙ 40 X 8



H.180 X L.400 mm.
Art. 12.087.11 ≙ 40 X 8



H.840 X L.140 mm.
Art. 12.087.12 ≙ 40 X 8



H.680 mm.
Art. 12.087.13 ≙ 40 X 8



H.400 X L.400 mm.
Art. 12.087.14 ≙ 40 X 8

Tutte le parti di questo catalogo - foto comprese - sono di proprietà Euro-Fer. La riproduzione, anche parziale, è vietata in ogni forma e con ogni mezzo. / Every part of this catalogue - photos included - is Euro-Fer's property. All forms of copying are strictly prohibited.



≅ 40 X 8
Art. 12.087.15 H.3000 mm.
Art. 12.087.16 H.6000 mm.



H.100 X L.400 mm.
Art. 12.087.17 ≅ 40 X 8



H.180 X L.400 mm.
Art. 12.087.18 ≅ 40 X 8



H.680 mm.
Art. 12.087.19 ≅ 40 X 8



H.840 mm.
Art. 12.087.20 ≅ 40 X 8



H.400 X L.400 mm.
Art. 12.087.21 ≅ 40 X 8



≅ 40 X 8
Art. 12.087.22 H.3000 mm.
Art. 12.087.23 H.6000 mm.



H.100 X L.400 mm.
Art. 12.087.24 ≅ 40 X 8



H.180 X L.400 mm.
Art. 12.087.25 ≅ 40 X 8



H.680 mm.
Art. 12.087.26 ≅ 40 X 8



H.460 mm.
Art. 12.087.27 ≅ 40 X 8



H.400 X L.400 mm.
Art. 12.087.28 ≅ 40 X 8



H.3000 mm
Art. 12.087.29 ≅ 50 X 10
Art. 12.087.36 ≅ 50 X 8
Art. 12.087.43 ≅ 40 X 8

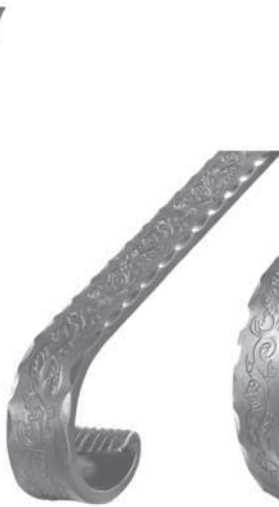

H.400 X L.100 mm.
Art. 12.087.31 ≅ 50 X 10
Art. 12.087.38 ≅ 50 X 8



H.400 X L.180 mm.
Art. 12.087.32 ≅ 50 X 10
Art. 12.087.39 ≅ 50 X 8



H.680 mm.
Art. 12.087.33 ≅ 50 X 10
Art. 12.087.40 ≅ 50 X 8



H.840 mm.
Art. 12.087.34 ≅ 50 X 10
Art. 12.087.41 ≅ 50 X 8



H.400 X L.400 mm.
Art. 12.087.35 ≅ 50 X 10
Art. 12.087.42 ≅ 50 X 8



Piatto Mod. Scala
Flat Scala Model

Piatto Mod. Scala
Flat Scala Model

- H.3000 mm.
- Art. 12.088 ≙ 30 X 8
 - Art. 12.089 ≙ 40 X 8
 - Art. 12.090 ≙ 40 X 10
 - Art. 12.091 ≙ 50 X 10
 - Art. 12.091.01 ≙ 60 X 8
- H.6000 mm.
- Art. 12.092 ≙ 30 X 8
 - Art. 12.093 ≙ 40 X 8
 - Art. 12.094 ≙ 40 X 10
 - Art. 12.095 ≙ 50 X 10
 - Art. 12.095.01 ≙ 60 X 8

- H.3000 mm.
- Art. 12.095.02 ≙ 10 X 5
 - Art. 12.095.03 ≙ 12 X 6
 - Art. 12.095.04 ≙ 14 X 6
 - Art. 12.095.05 ≙ 16 X 6
 - Art. 12.095.06 ≙ 20 X 6
 - Art. 12.095.30 ≙ 16 X 8
- H.6000 mm.
- Art. 12.095.07 ≙ 14 X 6
 - Art. 12.095.08 ≙ 16 X 6
 - Art. 12.095.09 ≙ 20 X 6
 - Art. 12.095.31 ≙ 16 X 8



Quadro Mod. Scala
Scala Model Square

- H.3000 mm.
- Art. 12.095.10 □ 8



Piatto Battuto in 2 Lati
Flat Bar Beaten in two sides

- H.3000 mm.
- Art. 12.095.11 ≙ 60 X 8
- H.6000 mm.
- Art. 12.095.12 ≙ 60 X 8



Piatto Battuto in 2 Lati
Flat Bar Beaten in two sides

- H.3000 mm.
- Art. 12.095.13 ≙ 25 X 10
 - Art. 12.095.14 ≙ 30 X 10
- H.6000 mm.
- Art. 12.095.15 ≙ 25 X 10
 - Art. 12.095.16 ≙ 30 X 10

Piatto Modello Mattone
Brick Model Flat section

- H.3000 mm.
- Art. 12.095.17 ≙ 20 X 4
 - Art. 12.095.18 ≙ 25 X 4
 - Art. 12.095.19 ≙ 25 X 6
 - Art. 12.095.20 ≙ 25 X 8
 - Art. 12.095.21 ≙ 30 X 4
 - Art. 12.095.22 ≙ 30 X 6
 - Art. 12.095.23 ≙ 30 X 8
 - Art. 12.095.24 ≙ 40 X 4
 - Art. 12.095.25 ≙ 40 X 6
 - Art. 12.095.26 ≙ 40 X 8

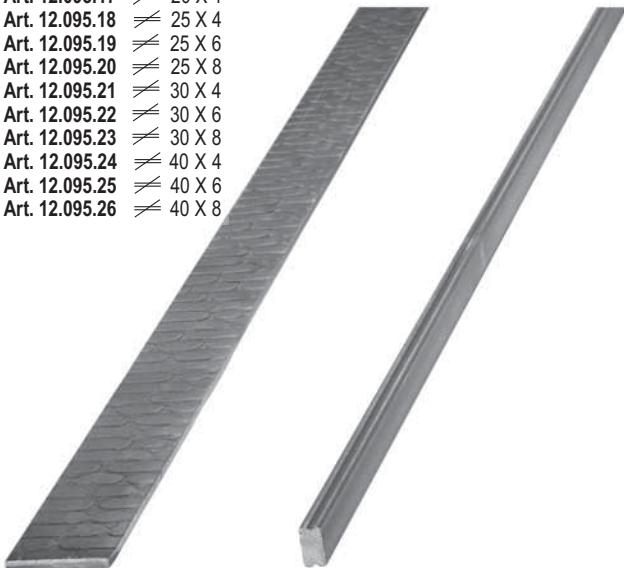

Quadro Mod. Mattone
Scala Brick Model

- H.3000 mm.
- Art. 12.095.27 □ 12
 - Art. 12.095.32 □ 14

Piatto Rigato sullo spessore
Scala Model Flat Bar beaten on Thickness

- H.3000 mm.
- Art. 12.095.28 ≙ 12 X 6
 - Art. 12.095.29 ≙ 16 X 8



Piatto Martellato 4 lati
Hammered Flat - 4 sides

- H.3000 mm.
- Art. 12.096 ≙ 20 X 10
 - Art. 12.096.01 ≙ 12 X 6
 - Art. 12.096.02 ≙ 16 X 8
 - Art. 12.097 ≙ 25 X 10
 - Art. 12.098 ≙ 30 X 8
 - Art. 12.098.01 ≙ 16 X 5
 - Art. 12.098.02 ≙ 20 X 6
 - Art. 12.098.03 ≙ 25 X 6
 - Art. 12.098.04 ≙ 25 X 8
 - Art. 12.098.05 ≙ 25 X 12
 - Art. 12.098.06 ≙ 30 X 10
 - Art. 12.098.07 ≙ 30 X 20
 - Art. 12.098.08 ≙ 35 X 8
 - Art. 12.098.09 ≙ 35 X 10
 - Art. 12.098.10 ≙ 40 X 8
 - Art. 12.098.11 ≙ 40 X 10
 - Art. 12.098.20 ≙ 35 X 15
 - Art. 12.098.21 ≙ 30 X 6
 - Art. 12.098.22 ≙ 50 X 8
 - Art. 12.098.26 ≙ 30 X 15
- H.6000 mm.
- Art. 12.098.12 ≙ 25 X 8
 - Art. 12.098.13 ≙ 25 X 12
 - Art. 12.098.14 ≙ 30 X 10
 - Art. 12.098.15 ≙ 30 X 20
 - Art. 12.098.16 ≙ 35 X 8
 - Art. 12.098.17 ≙ 35 X 10
 - Art. 12.098.18 ≙ 40 X 8
 - Art. 12.098.19 ≙ 40 X 10
 - Art. 12.098.23 ≙ 35 X 15
 - Art. 12.098.24 ≙ 30 X 6
 - Art. 12.098.25 ≙ 50 X 8
 - Art. 12.099 ≙ 20 X 10
 - Art. 12.100 ≙ 25 X 10
 - Art. 12.101 ≙ 30 X 8
 - Art. 12.098.27 ≙ 30 X 15



Piatto Mezzo Tondo
Half-Round Flat

- H.3000 mm.
- Art. 12.101.01 ≙ 30 X 15
 - Art. 12.101.02 ≙ 40 X 20
 - Art. 12.101.03 ≙ 50 X 25
 - Art. 12.101.04 ≙ 60 X 30
 - Art. 12.101.09 ≙ 16 X 8
 - Art. 12.101.10 ≙ 20 X 10
 - Art. 12.101.11 ≙ 35 X 15
 - Art. 12.101.12 ≙ 40 X 15
- H.6000 mm.
- Art. 12.101.05 ≙ 30 X 15
 - Art. 12.101.06 ≙ 40 X 20
 - Art. 12.101.07 ≙ 50 X 25
 - Art. 12.101.08 ≙ 60 X 30
 - Art. 12.101.13 ≙ 16 X 8
 - Art. 12.101.14 ≙ 20 X 10
 - Art. 12.101.15 ≙ 35 X 15
 - Art. 12.101.16 ≙ 40 X 15
 - Art. 12.101.20 ≙ 60 X 20

BARRE PER FASCETTE / COLLAR BARS

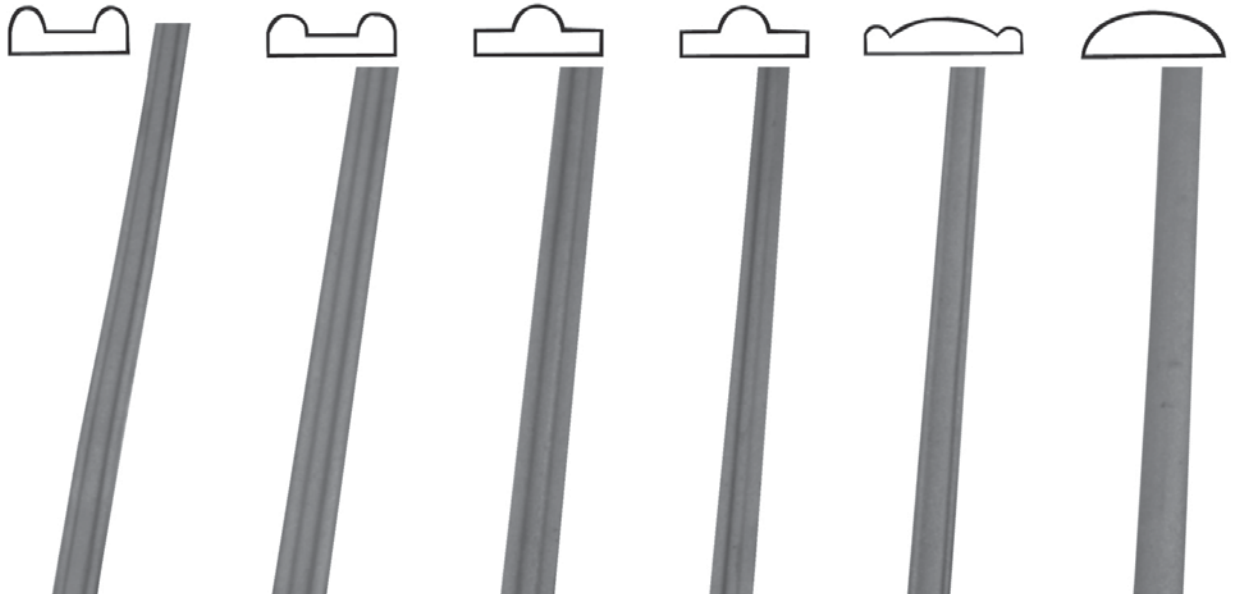

H.4000 mm.
Art. 12.108 \neq 14 X 4

H.3000 mm.
Art. 12.108.01 \neq 25 X 8
Art. 12.108.02 \neq 30 X 8
Art. 12.108.05 \neq 40 X 8

H.6000 mm.
Art. 12.108.03 \neq 25 X 8
Art. 12.108.04 \neq 30 X 8
Art. 12.108.06 \neq 40 X 8
Art. 12.108.08 \neq 40 X 13

H.4000 mm.
Art. 12.109 \neq 18 X 6

H.4000 mm.
Art. 12.110 \neq 18 X 5

H.4000 mm.
Art. 12.111 \neq 14 X 4

H.3000 mm.
Art. 12.112 \neq 10 X 3
Art. 12.113 \neq 12 X 3
Art. 12.114 \neq 14 X 3
Art. 12.115 \neq 16 X 4
Art. 12.116 \neq 20 X 4

Non Prod. / Not Prod.

H.4000 mm.
Art. 12.117 \neq 11 X 3
Art. 12.118 \neq 14 X 4
Art. 12.119 \neq 16 X 5
Art. 12.120 \neq 21 X 6



H.3000 mm.
Art. 12.120.02 \neq 15 X 3

H.3000 mm.
Art. 12.120.03 \neq 20 X 4



\neq 14 X 4 mm.
Art. 12.122 2 \neq 12 X 6
Art. 12.123 2 \neq 12 X 6
+ 1 \square 12 X 12
Art. 12.124 2 \square 8 X 8



\neq 18 X 6 mm.
Art. 12.125 1 \square 20 X 20



\neq 18 X 5 mm.
Art. 12.130 2 \neq 12 X 6
+ 1 \square 12 X 12



\neq 14 X 4 mm.
Art. 12.126 2 \neq 12 X 6
Art. 12.127 2 \neq 12 X 6
+ 1 \square 12 X 12
Art. 12.128 2 \square 8 X 8
Art. 12.129 3 \square 8 X 8



\neq 14 X 4 mm.
Art. 12.131 2 \neq 20 X 6
Art. 12.132 3 \neq 20 X 4
Art. 12.133 3 \neq 20 X 6
Art. 12.134 2 \neq 12 X 6
+ 1 \square 12 X 12



- H.3000 mm.
- Art. 12.135 ≡ 16 X 4
 - Art. 12.136 ≡ 20 X 4
 - Art. 12.137 ≡ 30 X 4
 - Art. 12.138 ≡ 25 X 5
- H.6000 mm.
- Art. 12.139 ≡ 16 X 4
 - Art. 12.140 ≡ 20 X 4
 - Art. 12.141 ≡ 30 X 4
 - Art. 12.142 ≡ 25 X 5
- H.3000 mm.
- Art. 12.143 □ 6 X 6
 - Art. 12.144 □ 8 X 8
 - Art. 12.145 □ 10 X 10
 - Art. 12.146 □ 12 X 12
 - Art. 12.147 □ 14 X 14
 - Art. 12.148 □ 16 X 16
 - Art. 12.149 □ 18 X 18
 - Art. 12.150 □ 20 X 20
 - Art. 12.151 □ 25 X 25
 - Art. 12.152 □ 30 X 30
 - Art. 12.153 □ 35 X 35
 - Art. 12.154 □ 40 X 40
- H.6000 mm.
- Art. 12.155 □ 6 X 6
 - Art. 12.156 □ 8 X 8
 - Art. 12.157 □ 10 X 10
 - Art. 12.158 □ 12 X 12
 - Art. 12.159 □ 14 X 14
 - Art. 12.160 □ 16 X 16
 - Art. 12.161 □ 18 X 18
 - Art. 12.162 □ 20 X 20
 - Art. 12.163 □ 25 X 25
 - Art. 12.164 □ 30 X 30
 - Art. 12.165 □ 35 X 35
 - Art. 12.166 □ 40 X 40

- Mod. Liquirizia
Liquorice Model
- H.3000 mm.
- Art. 12.166.01 □ 12 X 12
 - Art. 12.166.02 □ 14 X 14
 - Art. 12.166.03 □ 16 X 16

- Funi con Tondino
- H.5700 mm.
- Art. 12.167 Ø 16
 - Art. 12.168 Ø 20
 - Art. 12.169 Ø 25
 - Art. 12.170 Ø 30

- Funi con Quadro
- H.5700 mm.
- Art. 12.171 □ 23 X 23
 - Art. 12.172 □ 28 X 28
 - Art. 12.173 □ 34 X 34
 - Art. 12.174 □ 39 X 39

- Quadro Martellato
Hammered Square
- H.3000 mm.
- Art. 12.175 □ 12 X 12
 - Art. 12.176 □ 14 X 14
 - Art. 12.177 □ 16 X 16
 - Art. 12.178 □ 20 X 20
 - Art. 12.179 □ 25 X 25
 - Art. 12.180 □ 30 X 30
 - Art. 12.181 □ 40 X 40
 - Art. 12.181.01 □ 18 X 18
 - Art. 12.181.02 □ 35 X 35
- H.6000 mm.
- Art. 12.182 □ 12 X 12
 - Art. 12.183 □ 14 X 14
 - Art. 12.184 □ 16 X 16
 - Art. 12.185 □ 20 X 20
 - Art. 12.186 □ 25 X 25
 - Art. 12.187 □ 30 X 30
 - Art. 12.188 □ 40 X 40
 - Art. 12.188.01 □ 18 X 18
 - Art. 12.188.02 □ 35 X 35

- Tondo Martellato
Hammered Round
- H.3000 mm.
- Art. 12.175.01 Ø 12
 - Art. 12.176.01 Ø 14
 - Art. 12.176.02 Ø 16
 - Art. 12.176.03 Ø 18
 - Art. 12.176.04 Ø 20
 - Art. 12.176.05 Ø 25
 - Art. 12.176.06 Ø 30
- H.6000 mm.
- Art. 12.182.01 Ø 12
 - Art. 12.183.01 Ø 14
 - Art. 12.183.02 Ø 16
 - Art. 12.183.03 Ø 18
 - Art. 12.183.04 Ø 20
 - Art. 12.183.05 Ø 25
 - Art. 12.183.06 Ø 30



Tutte le parti di questo catalogo - foto comprese - sono di proprietà Euro-Fer. La riproduzione, anche parziale, è vietata in ogni forma e con ogni mezzo. / Every part of this catalogue - photos included - is Euro-Fer's property. All forms of copying are strictly prohibited.

Rigato + Martellato
Hammered Fluted

H.3000 mm.

Art. 12.189 □ 12 X 12
Art. 12.190 □ 14 X 14

H.6000 mm.

Art. 12.191 □ 12 X 12
Art. 12.192 □ 14 X 14Barre in Spigolo
Edged Bar

H.3000 mm.

Art. 12.192.01 □ 12 X 12
Art. 12.192.02 □ 14 X 14
Art. 12.192.03 □ 16 X 16
Art. 12.192.04 □ 18 X 18
Art. 12.192.05 □ 20 X 20

H.6000 mm.

Art. 12.192.06 □ 12 X 12
Art. 12.192.07 □ 14 X 14
Art. 12.192.08 □ 16 X 16
Art. 12.192.09 □ 18 X 18
Art. 12.192.10 □ 20 X 20
Art. 12.192.11 □ 25 X 25
Art. 12.192.12 □ 30 X 30Rigato 4 facce
Fluted 4 faces

H.3000 mm.

Art. 12.193 □ 12 X 12
Art. 12.194 □ 14 X 14
Art. 12.194.01 □ 16 X 16

H.6000 mm.

Art. 12.195 □ 12 X 12
Art. 12.196 □ 14 X 14
Art. 12.194.02 □ 16 X 16Rigato 2 facce
Fluted 2 faces

H.3000 mm.

Art. 12.194.03 □ 12
Art. 12.194.04 □ 14
Art. 12.194.05 □ 16

H.6000 mm.

Art. 12.194.06 □ 12
Art. 12.194.07 □ 14
Art. 12.194.08 □ 16Modello Corteccia
Bark Model

H.3000 mm.

Art. 12.196.01 Ø 14
Art. 12.196.02 Ø 16
Art. 12.196.03 Ø 20
Art. 12.196.04 Ø 22
Art. 12.196.09 Ø 18
Art. 12.196.10 Ø 25
Art. 12.196.11 Ø 30
Art. 12.196.15 Ø 12

H.6000 mm.

Art. 12.196.05 Ø 14
Art. 12.196.06 Ø 16
Art. 12.196.07 Ø 20
Art. 12.196.08 Ø 22
Art. 12.196.12 Ø 18
Art. 12.196.13 Ø 25
Art. 12.196.14 Ø 30
Art. 12.196.16 Ø 12Modello Corteccia
Bark Model

H.3000 mm.

Art. 12.196.50 □ 12
Art. 12.196.51 □ 14
Art. 12.196.52 □ 16

H.6000 mm.

Art. 12.196.61 □ 12
Art. 12.196.62 □ 14
Art. 12.196.63 □ 16Modello Scala
Scala Model

H.3000 mm.

Art. 12.197 □ 12 X 12
Art. 12.198 □ 14 X 14
Art. 12.199 □ 16 X 16
Art. 12.200 □ 18 X 18
Art. 12.201 □ 20 X 20
Art. 12.202 □ 25 X 25
Art. 12.203 □ 30 X 30
Art. 12.204 □ 40 X 40

H.6000 mm.

Art. 12.205 □ 12 X 12
Art. 12.206 □ 14 X 14
Art. 12.207 □ 16 X 16
Art. 12.208 □ 18 X 18
Art. 12.209 □ 20 X 20
Art. 12.210 □ 25 X 25
Art. 12.211 □ 30 X 30
Art. 12.212 □ 40 X 40Piatto Modello Scala
Flat Scala Model

H.3000 mm.

Art. 12.204.01 ≧ 30 X 20

H.6000 mm.

Art. 12.212.01 ≧ 30 X 20

Quadro battuto 4 lati
Square Bars Hammered on 4 sides

H.3000 mm.

Art. 12.213 □ 12 X 12
Art. 12.214 □ 14 X 14
Art. 12.215 □ 16 X 16
Art. 12.216 □ 18 X 18
Art. 12.217 □ 20 X 20
Art. 12.218 □ 25 X 25
Art. 12.219 □ 30 X 30
Art. 12.220 □ 35 X 35
Art. 12.221 □ 40 X 40

H.6000 mm.

Art. 12.222 □ 12 X 12
Art. 12.223 □ 14 X 14
Art. 12.224 □ 16 X 16
Art. 12.225 □ 18 X 18
Art. 12.226 □ 20 X 20
Art. 12.227 □ 25 X 25
Art. 12.228 □ 30 X 30
Art. 12.229 □ 35 X 35
Art. 12.230 □ 40 X 40Piatto battuto 2 lati
Flat Bars Hammered on 2 sides

H.3000 mm.

Art. 12.221.01 ≧ 30 X 20

H.6000 mm.

Art. 12.228.01 ≧ 30 X 20

Tube martellato / Tube hammered

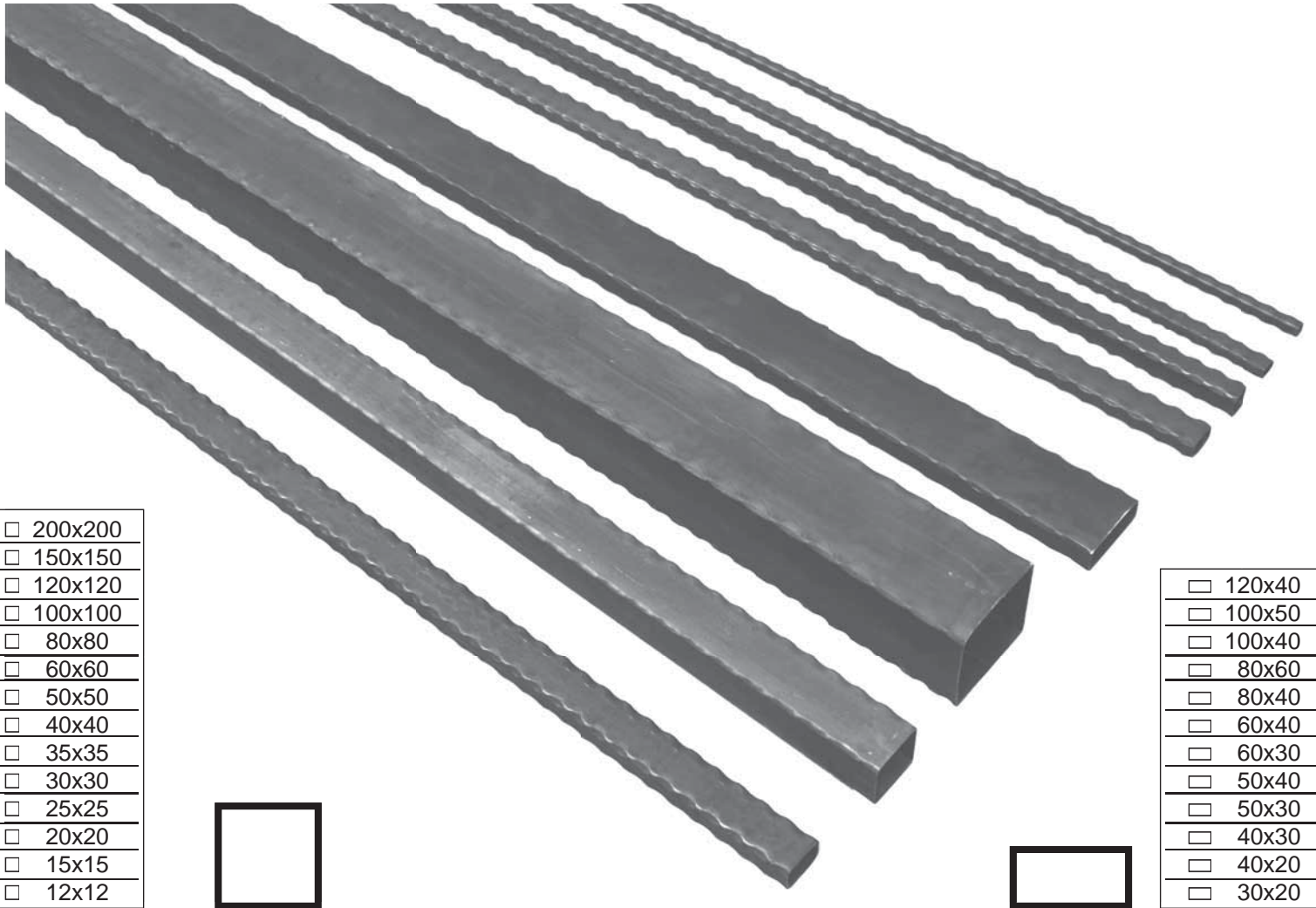

<input type="checkbox"/> 200x200
<input type="checkbox"/> 150x150
<input type="checkbox"/> 120x120
<input type="checkbox"/> 100x100
<input type="checkbox"/> 80x80
<input type="checkbox"/> 60x60
<input type="checkbox"/> 50x50
<input type="checkbox"/> 40x40
<input type="checkbox"/> 35x35
<input type="checkbox"/> 30x30
<input type="checkbox"/> 25x25
<input type="checkbox"/> 20x20
<input type="checkbox"/> 15x15
<input type="checkbox"/> 12x12

<input type="checkbox"/> 120x40
<input type="checkbox"/> 100x50
<input type="checkbox"/> 100x40
<input type="checkbox"/> 80x60
<input type="checkbox"/> 80x40
<input type="checkbox"/> 60x40
<input type="checkbox"/> 60x30
<input type="checkbox"/> 50x40
<input type="checkbox"/> 50x30
<input type="checkbox"/> 40x30
<input type="checkbox"/> 40x20
<input type="checkbox"/> 30x20

200 X 200 X 4 mm.
Art. 12.230.07 H.3000 mm.
Art. 12.230.08 H.6000 mm.

40 X 40 X 2,5 mm.
Art. 12.237 H.3000 mm.
Art. 12.238 H.6000 mm.

120X 40 X 3 mm.
Art. 12.244.08 H.3000 mm.
Art. 12.244.11 H.6000 mm.

60X 30 X 2,5 mm.
Art. 12.246.01 H.3000 mm.
Art. 12.246.02 H.6000 mm.

150 X 150 X 4 mm.
Art. 12.230.05 H.3000 mm.
Art. 12.230.06 H.6000 mm.

35 X 35 X 2,5 mm.
Art. 12.238.01 H.3000 mm.
Art. 12.238.02 H.6000 mm.

100X 50 X 3 mm.
Art. 12.244.07 H.3000 mm.
Art. 12.244.10 H.6000 mm.

50X 40 X 2,5 mm.
Art. 12.247 H.3000 mm.
Art. 12.248 H.6000 mm.

120 X 120 X 3 mm.
Art. 12.230.01 H.3000 mm.
Art. 12.230.02 H.6000 mm.

30 X 30 X 2,5 mm.
Art. 12.239 H.3000 mm.
Art. 12.240 H.6000 mm.

100X 40 X 3 mm.
Art. 12.244.03 H.3000 mm.
Art. 12.244.04 H.6000 mm.

50X 30 X 2,5 mm.
Art. 12.249 H.3000 mm.
Art. 12.250 H.6000 mm.

100 X 100 X 3 mm.
Art. 12.230.03 H.3000 mm.
Art. 12.230.04 H.6000 mm.

25 X 25 X 2,5 mm.
Art. 12.241 H.3000 mm.
Art. 12.242 H.6000 mm.

80X 60 X 3 mm.
Art. 12.244.09 H.3000 mm.
Art. 12.244.12 H.6000 mm.

40X 30 X 2,5 mm.
Art. 12.250.01 H.3000 mm.
Art. 12.250.02 H.6000 mm.

80 X 80 X 2,5 mm.
Art. 12.231 H.3000 mm.
Art. 12.232 H.6000 mm.

60 X 60 X 2,5 mm.
Art. 12.233 H.3000 mm.
Art. 12.234 H.6000 mm.

H.3000 mm.
Art. 12.243 20 X 20 X 2
Art. 12.244.01 12 X 12 X 1,5
Art. 12.244.02 15 X 15 X 1,5
H.6000 mm.
Art. 12.244 20 X 20 X 2

80X 40 X 2,5 mm.
Art. 12.244.05 H.3000 mm.
Art. 12.244.06 H.6000 mm.

40X 20 X 2 mm.
Art. 12.251 H.3000 mm.
Art. 12.252 H.6000 mm.

50 X 50 X 2,5 mm.
Art. 12.235 H.3000 mm.
Art. 12.236 H.6000 mm.

60X 40 X 2,5 mm.
Art. 12.245 H.3000 mm.
Art. 12.246 H.6000 mm.

30X 20 X 2 mm.
Art. 12.253 H.3000 mm.
Art. 12.254 H.6000 mm.

Tutte le parti di questo catalogo - foto comprese - sono di proprietà Euro-Fer. La riproduzione, anche parziale, è vietata in ogni forma e con ogni mezzo. / Every part of this catalogue - photos included - is Euro-Fer's property. All forms of copying are strictly prohibited.



H.3000 mm.
Art. 12.261 □ 16 mm



H.3000 mm.
Art. 12.262 □ 15 mm



PROFILO A NUVOLA
'CLOUD' PROFILE

H.4000 mm.
Art. 12.263 ≡ 20 X 12 mm

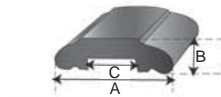
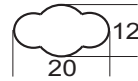

H.3000 mm
Art. 12.270 ≡ A = 55 / B = 17 / C = 25 mm
Art. 12.270.01 ≡ A = 45 / B = 15 / C = 22 mm

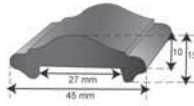

H.3000 mm.
Art. 12.271 ≡ 45 X 15 mm

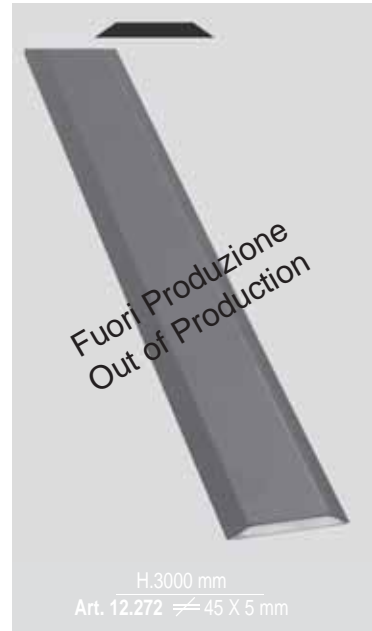

H.3000 mm
Art. 12.272 ≡ 45 X 5 mm

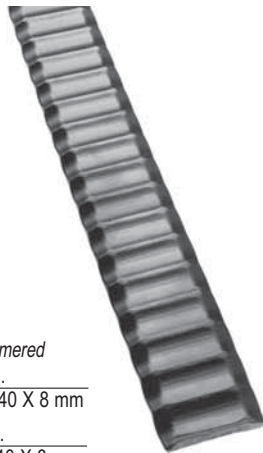

Martellato / Hammered
H.3000 mm.
Art. 12.273 ≡ 40 X 8 mm
H.6000 mm.
Art. 12.273.01 ≡ 40 X 8 mm



Lavorato / Worked
H.3000 mm.
Art.12.274 ≡ 40 x 8 mm



PARTENZone

Stop agli allineamenti e alla saldatura tra partenza e corrimano.

Ecco la prima rampa della tua scala in un unico pezzo già pronta per l'installazione e facilmente adattabile alle tue esigenze con un semplice taglio. 



PARTENZone

Stop alignments and welding between start and handrails.

Here is the first flight of your staircase in one piece ready for installation that can easily be adapted to your needs with a simple cut. 

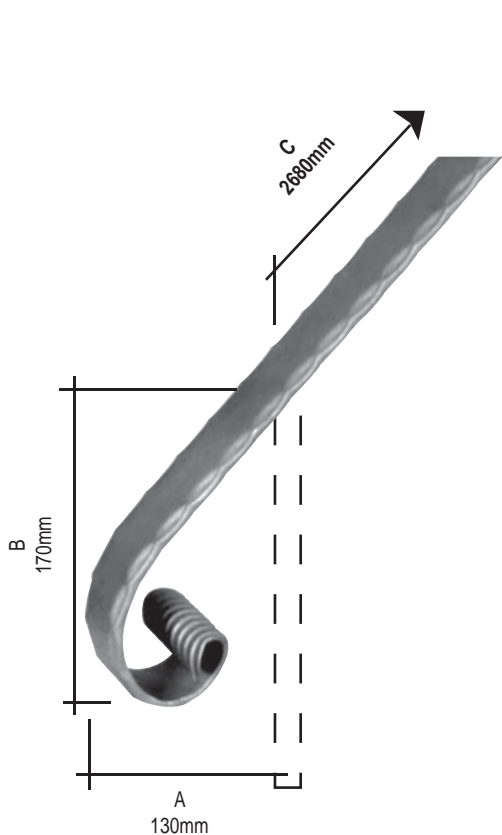
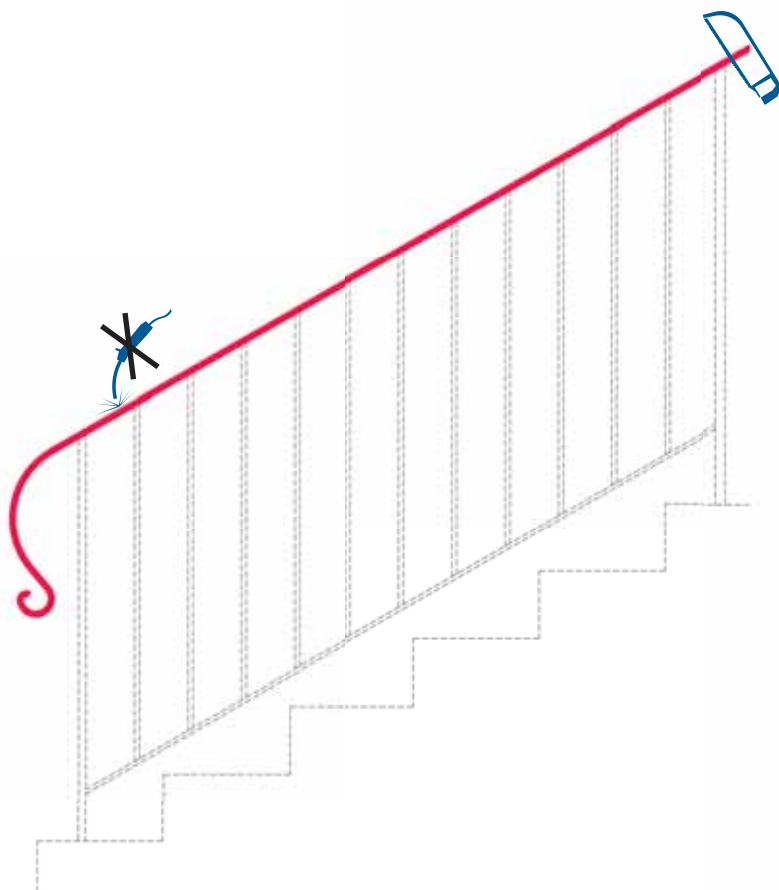

Martellato / Hammered
Art.12.P1.013 \neq 40 x 8 mm

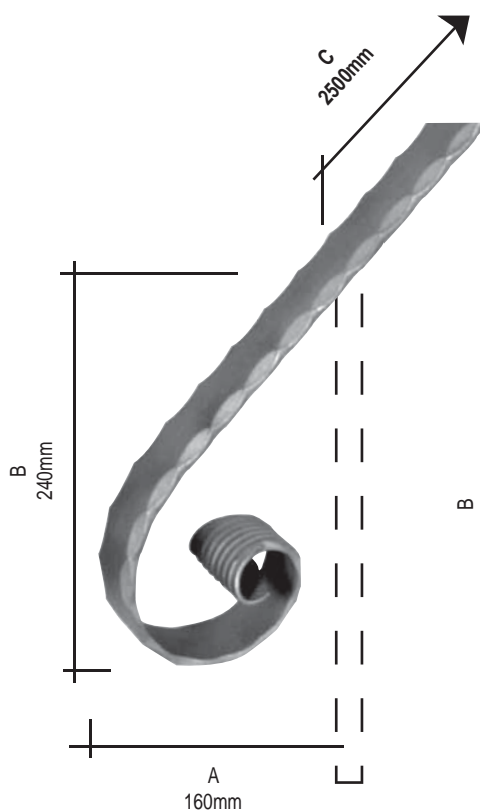

Martellato / Hammered
Art.12.P1.015 \neq 40 x 8 mm

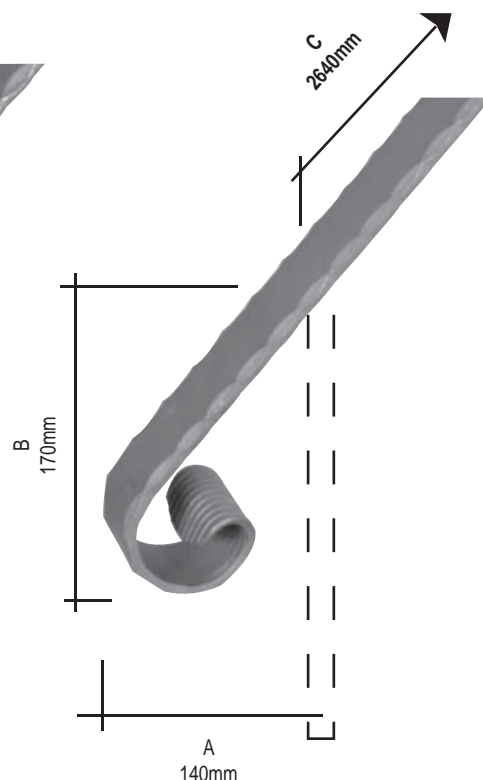

Martellato / Hammered
Art.12.P1.017 \neq 40 x 8 mm
Art.12.P1.018 \neq 50 x 10 mm

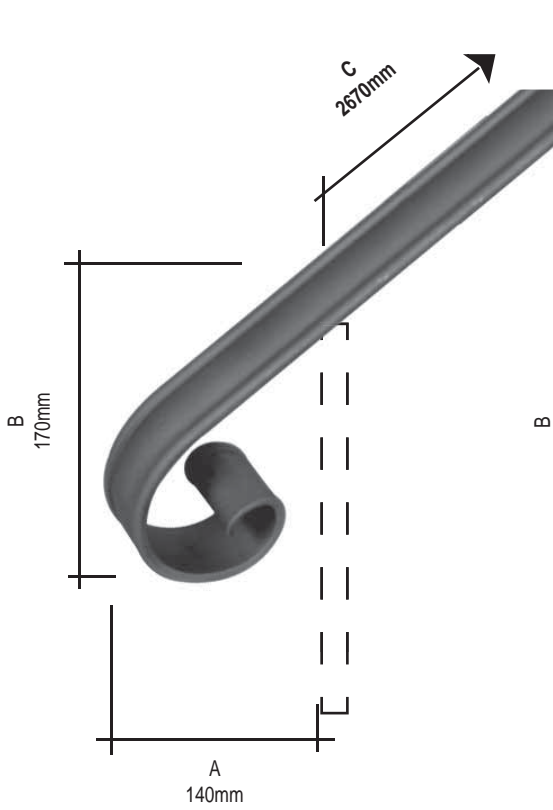

Art.12.P1.056 40 x 8 mm

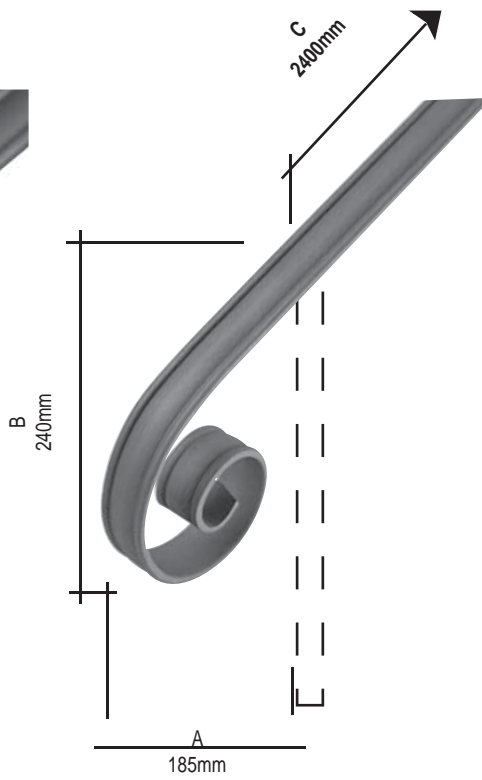

Art.12.P1.056.01 40 x 8 mm

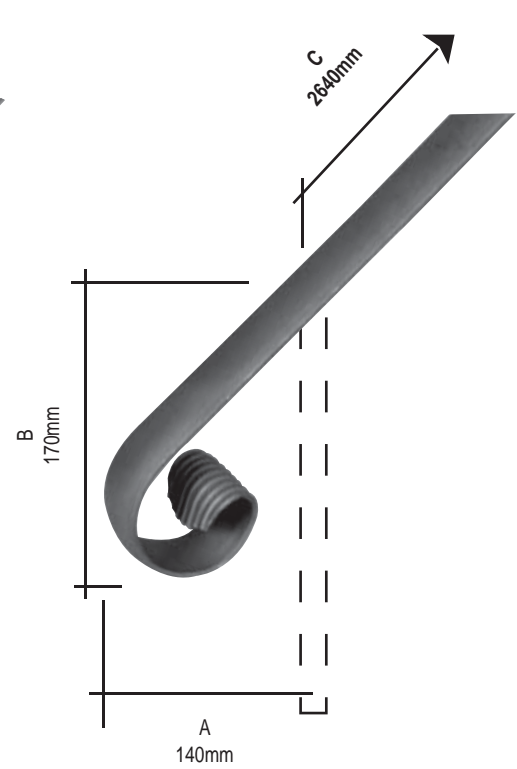

Art.12.P1.072 40 x 8 mm
Art.12.P1.073 40 x 10 mm
Art.12.P1.074 40 x 12 mm
Art.12.P1.075 50 x 10 mm

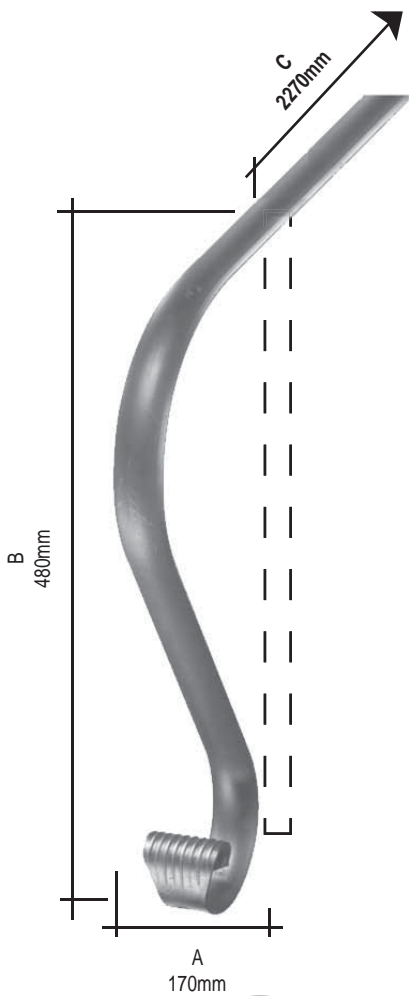

Art.12.P1.078.01 40 x 10 mm
Art.12.P1.079 40 x 12 mm

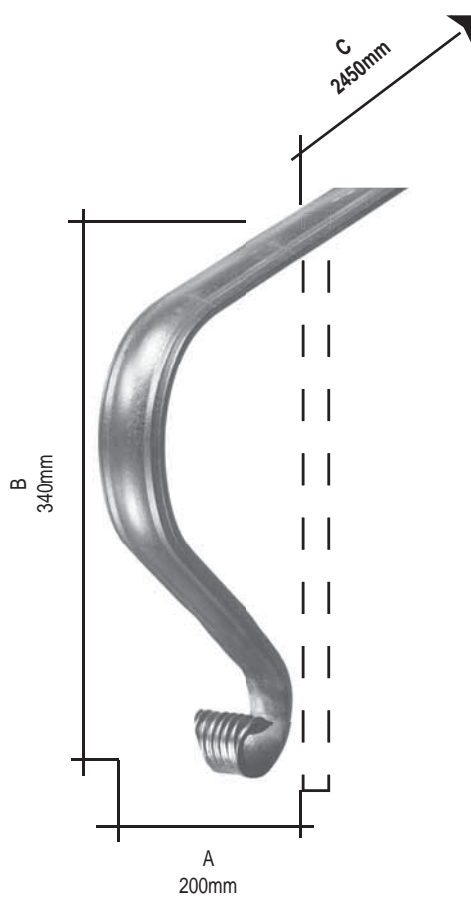

Art.12.P1.086 50 x 14 mm
Art.12.P1.086.01 40 x 12 mm
Art.12.P1.086.02 45 x 12 mm

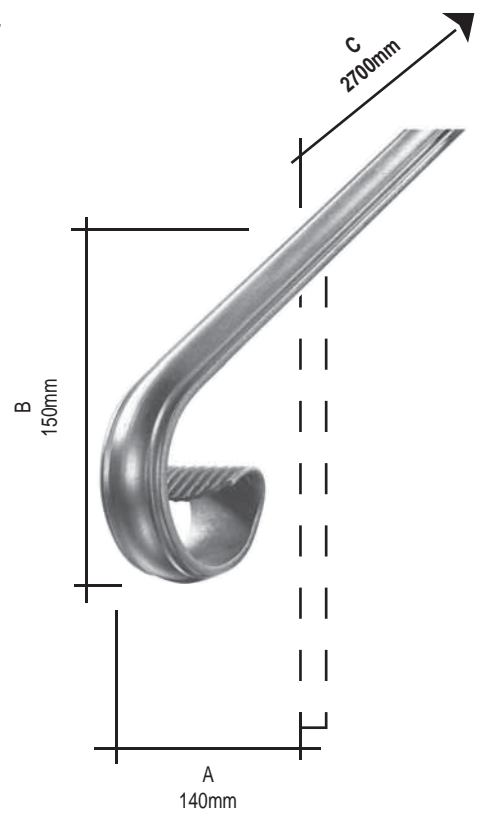

Art.12.P1.086.12 50 x 14 mm
Art.12.P1.086.13 40 x 12 mm
Art.12.P1.086.14 45 x 12 mm
Art.12.P1.086.15 60 x 16 mm

Tutte le parti di questo catalogo - foto comprese - sono di proprietà Euro-Fer. La riproduzione, anche parziale, è vietata in ogni forma e con ogni mezzo. / Every part of this catalogue - photos included - is Euro-Fer's property. All forms of copying are strictly prohibited.

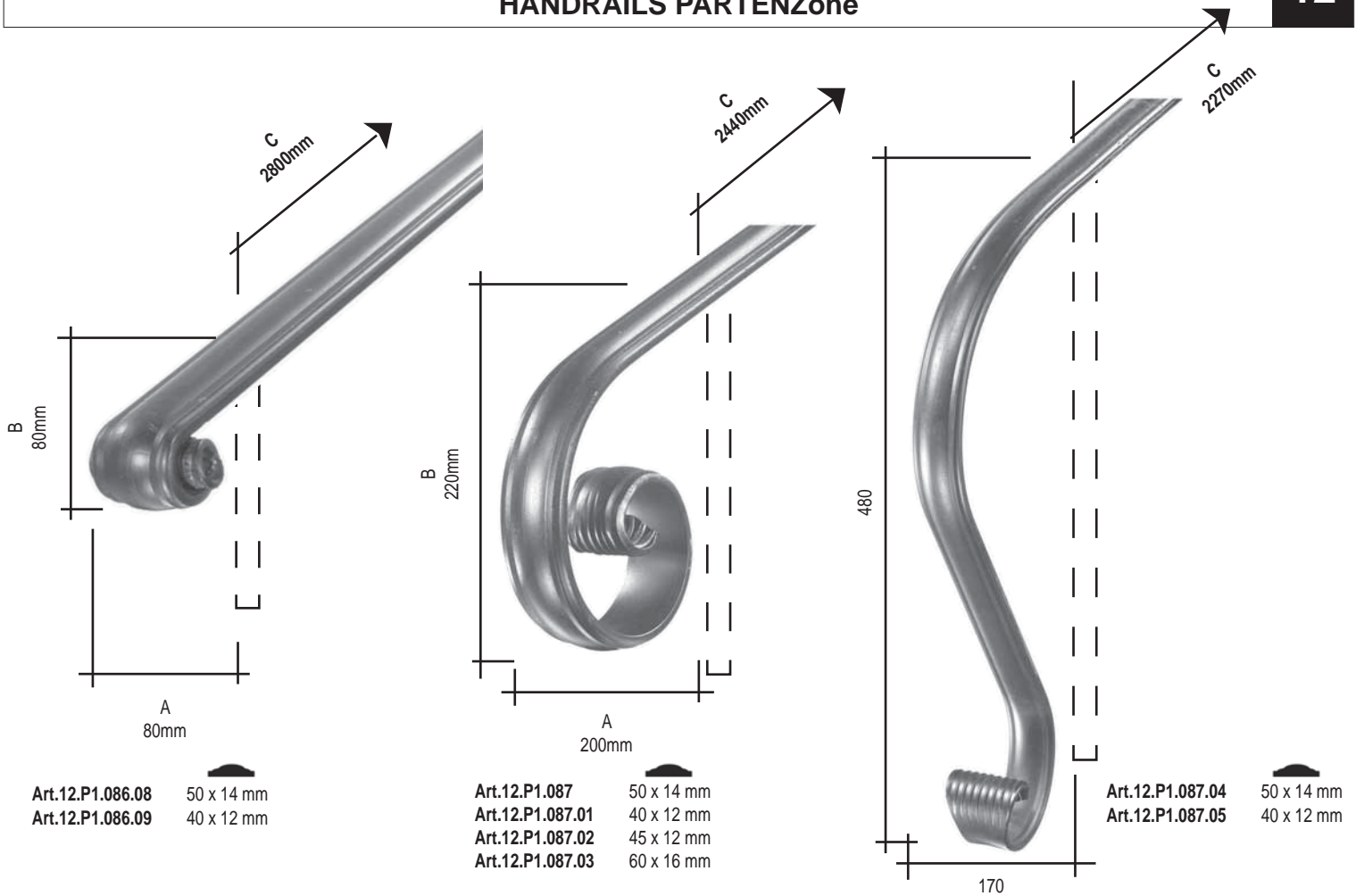

			C
<input type="checkbox"/>	Art.12.P1.013	40 x 8 mm	2680 mm
<input type="checkbox"/>	Art.12.P1.015	40 x 8 mm	2500 mm
<input type="checkbox"/>	Art.12.P1.017	40 x 8 mm	2640 mm
<input type="checkbox"/>	Art.12.P1.018	50 x 10 mm	2640 mm
<input type="checkbox"/>	Art.12.P1.056	40 x 8 mm	2670 mm
<input type="checkbox"/>	Art.12.P1.056.01	40 x 8 mm	2400 mm
<input type="checkbox"/>	Art.12.P1.072	40 x 8 mm	2640 mm
<input type="checkbox"/>	Art.12.P1.073	40 x 10 mm	2640 mm
<input type="checkbox"/>	Art.12.P1.074	40 x 12 mm	2640 mm
<input type="checkbox"/>	Art.12.P1.075	50 x 10 mm	2640 mm
<input type="checkbox"/>	Art.12.P1.078.01	40 x 10 mm	2270 mm
<input type="checkbox"/>	Art.12.P1.079	40 x 12 mm	2270 mm
<input type="checkbox"/>	Art.12.P1.086	50 x 14 mm	2450 mm
<input type="checkbox"/>	Art.12.P1.086.01	40 x 12 mm	2450 mm
<input type="checkbox"/>	Art.12.P1.086.02	45 x 12 mm	2450 mm
<input type="checkbox"/>	Art.12.P1.086.08	50 x 14 mm	2800 mm
<input type="checkbox"/>	Art.12.P1.086.09	40 x 12 mm	2800 mm
<input type="checkbox"/>	Art.12.P1.086.12	50 x 14 mm	2700 mm
<input type="checkbox"/>	Art.12.P1.086.13	40 x 12 mm	2700 mm
<input type="checkbox"/>	Art.12.P1.086.14	45 x 12 mm	2700 mm
<input type="checkbox"/>	Art.12.P1.086.15	60 x 16 mm	2700 mm
<input type="checkbox"/>	Art.12.P1.087	50 x 14 mm	2440 mm
<input type="checkbox"/>	Art.12.P1.087.01	40 x 12 mm	2440 mm
<input type="checkbox"/>	Art.12.P1.087.02	45 x 12 mm	2440 mm
<input type="checkbox"/>	Art.12.P1.087.03	60 x 16 mm	2440 mm
<input type="checkbox"/>	Art.12.P1.087.04	50 x 14 mm	2270 mm
<input type="checkbox"/>	Art.12.P1.087.05	40 x 12 mm	2270 mm

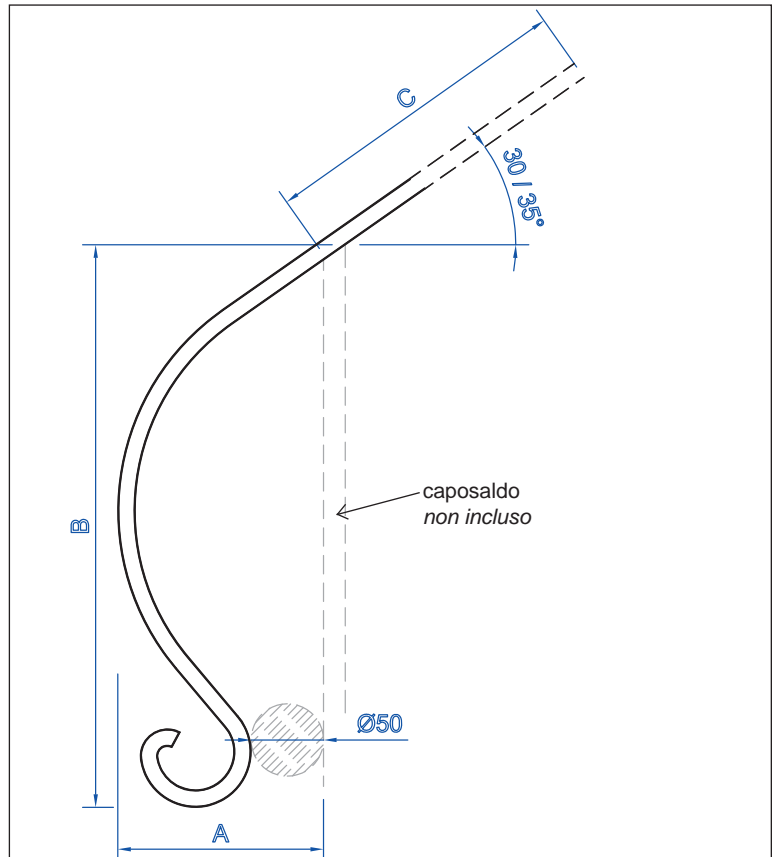

**BORCHIE, LANCE E PIASTRE
STUDS, SPEARS AND PLATES**



H.200 mm.
Art. 13.001 □ 12
Art. 13.002 □ 14
Art. 13.003 □ 16



Fiamma Grande / Big Flame
Liscio / Smooth
H.250X L.48 mm
Art. 13.001.02 □ 12
H.250X L.51 mm
Art. 13.001.03 □ 14
H.250X L.54 mm
Art. 13.001.04 □ 16



Martellato / Hammered
H.200 mm.
Art. 13.003.01 □ 12
Art. 13.003.02 □ 14
Art. 13.003.03 □ 16



Tondo / Round
H.200 mm.
Art. 13.003.04 Ø12
Art. 13.003.05 Ø14
Art. 13.003.06 Ø16



Fiamma Grande / Big Flame
Tondo / Round
H.250X L.48 mm
Art. 13.003.07 Ø 12
H.250X L.51 mm
Art. 13.003.08 Ø 14
H.250X L.54 mm
Art. 13.003.09 Ø 16



Fiamma Grande / Big Flame
Martellato / Hammered
H.250X L.48 mm
Art. 13.003.10 □ 12
H.250X L.51 mm
Art. 13.003.11 □ 14
H.250X L.54 mm
Art. 13.003.12 □ 16



H.200 mm.
Art. 13.004 □ 12
Art. 13.005 □ 14
Art. 13.006 □ 16



Martellato / Hammered
H.200 mm.
Art. 13.006.01 □ 12
Art. 13.006.02 □ 14
Art. 13.006.03 □ 16



Tondo / Round
H.200 mm.
Art. 13.006.04 Ø12
Art. 13.006.05 Ø14
Art. 13.006.06 Ø16



H.250 mm.
Art. 13.007 □ 12
Art. 13.008 □ 14
Art. 13.009 □ 16



Martellato / Hammered
H.250 mm.
Art. 13.009.01 □ 12
Art. 13.009.02 □ 14
Art. 13.009.03 □ 16



Tondo / Round
H.250 mm.
Art. 13.009.04 Ø14
Art. 13.009.05 Ø16



H.200 mm.
Art. 13.010 □ 12
Art. 13.011 □ 14
Art. 13.012 □ 16



Martellato / Hammered
H.200 mm.
Art. 13.012.01 □ 12
Art. 13.012.02 □ 14
Art. 13.012.03 □ 16



Tondo / Round
H.200 mm.
Art. 13.012.04 Ø12
Art. 13.012.05 Ø14
Art. 13.012.06 Ø16



Fiamma grande / Big flame

Liscio / Smooth
H.250X L.48 mm
Art. 13.012.20 □ 12
H.250X L.51 mm
Art. 13.012.21 □ 14
H.250X L.54 mm
Art. 13.012.22 □ 16
H.250X L.48 mm
Art. 13.012.23 Ø 12
H.250X L.51 mm
Art. 13.012.24 Ø 14
H.250X L.54 mm
Art. 13.012.25 Ø 16



H.200 mm.
Art. 13.013 □ 12
Art. 13.014 □ 14
Art. 13.015 □ 16



Martellato / Hammered
H.200 mm.
Art. 13.015.01 □ 12
Art. 13.015.02 □ 14
Art. 13.015.03 □ 16



Tondo / Round
H.200 mm.
Art. 13.015.04 Ø12
Art. 13.015.05 Ø14
Art. 13.015.06 Ø16



H.150 mm.
Art. 13.016 □ 12
Art. 13.017 □ 14
Art. 13.018 □ 16

Fiamma grande / Big flame



Tondo / Round
H.250 mm.
Art. 13.015.20 Ø12



Martellato / Hammered
H.150 mm.
Art. 13.018.01 □ 12
Art. 13.018.02 □ 14
Art. 13.018.03 □ 16



Tondo / Round
H.150 mm.
Art. 13.018.04 Ø12
Art. 13.018.05 Ø14
Art. 13.018.06 Ø16



H.200 mm.
Art. 13.018.07 □ 12
Art. 13.018.08 □ 14
Art. 13.018.09 □ 16



Martellato / Hammered
H.200 mm.
Art. 13.018.10 □ 12
Art. 13.018.11 □ 14
Art. 13.018.12 □ 16



H.200 mm.
Art. 13.018.13 □ 12
Art. 13.018.14 □ 14
Art. 13.018.15 □ 16



Martellato / Hammered
H.200 mm.
Art. 13.018.16 □ 12
Art. 13.018.17 □ 14
Art. 13.018.18 □ 16



Modello Catania / Catania model



H.200 mm.
Art. 13.018.19 12
Art. 13.018.20 14
Art. 13.018.21 16

Martellato / Hammered
H.200 mm.
Art. 13.018.22 12
Art. 13.018.23 14
Art. 13.018.24 16

H.200 mm.
Art. 13.019 12
Art. 13.020 14
Art. 13.021 16

H.200 mm.
Art. 13.022 12
Art. 13.023 14
Art. 13.024 16

Liscio / Smooth
H.200 mm
Art. 13.024.50 12
Art. 13.024.51 14
Art. 13.024.52 16
Art. 13.024.53 18
Art. 13.024.54 20

Liscio / Smooth
H.200 mm
Art. 13.024.55 12
Art. 13.024.56 14
Art. 13.024.57 16
Art. 13.024.58 18
Art. 13.024.59 20

Liscio / Smooth
H.200 mm
Art. 13.024.100 12
Art. 13.024.101 14

Liscio / Smooth
H.200 mm
Art. 13.024.110 12
Art. 13.024.111 14

Liscio / Smooth
H.200 mm

Liscio / Smooth
H.200 mm

<p>Sfera / Sphere Ø20 Art. 13.024.145 <input type="checkbox"/> 12</p> <p>Sfera / Sphere Ø25 Art. 13.024.150 <input type="checkbox"/> 12 Art. 13.024.151 <input type="checkbox"/> 14 Art. 13.024.153 <input type="checkbox"/> 12</p> <p>Sfera / Sphere Ø30 Art. 13.024.156 <input type="checkbox"/> 12 Art. 13.024.157 <input type="checkbox"/> 14</p>	<p>Sfera / Sphere Ø35 Art. 13.024.159 <input type="checkbox"/> 12 Art. 13.024.160 <input type="checkbox"/> 16</p> <p>Sfera / Sphere Ø25 Art. 13.024.161 <input type="checkbox"/> 12 Art. 13.024.162 <input type="checkbox"/> 14</p> <p>Sfera Forgiata Ø 25 / Forged Sphere Ø 25 Art. 13.024.170 <input type="checkbox"/> 12</p>
---	---



<p>H.200 mm. Art. 13.025 <input type="checkbox"/> 12 Art. 13.026 <input type="checkbox"/> 14 Art. 13.027 <input type="checkbox"/> 16 Art. 13.027.01 <input type="checkbox"/> 18</p>	<p>Martellato / Hammered H.200 mm. Art. 13.027.02 <input type="checkbox"/> 12 Art. 13.027.03 <input type="checkbox"/> 14 Art. 13.027.04 <input type="checkbox"/> 16 Art. 13.027.05 <input type="checkbox"/> 18</p>	<p>Tondo / Round H.200 mm. Art. 13.027.06 <input type="checkbox"/> 12 Art. 13.027.07 <input type="checkbox"/> 14 Art. 13.027.08 <input type="checkbox"/> 16 Art. 13.027.09 <input type="checkbox"/> 18 Art. 13.027.10 <input type="checkbox"/> 20</p>
---	--	---

Liscio / Smooth
H.250 mm
Art. 13.027.40 12
Art. 13.027.41 14

Liscio / Smooth
H.250 mm
Art. 13.027.43 12
Art. 13.027.44 14
Art. 13.027.45 16



<p>Liscio / Smooth H.200 mm Art. 13.027.50 <input type="checkbox"/> 12 Art. 13.027.51 <input type="checkbox"/> 14 Art. 13.027.52 <input type="checkbox"/> 16</p>	<p>Liscio / Smooth H.200 mm Art. 13.027.55 <input type="checkbox"/> 12 Art. 13.027.56 <input type="checkbox"/> 14 Art. 13.027.57 <input type="checkbox"/> 16</p>	<p>H.200 mm. Art. 13.028 <input type="checkbox"/> 12 Art. 13.029 <input type="checkbox"/> 14 Art. 13.030 <input type="checkbox"/> 16 Art. 13.030.01 <input type="checkbox"/> 18 Art. 13.030.02 <input type="checkbox"/> 20</p>	<p>Martellato / Hammered H.200 mm. Art. 13.030.03 <input type="checkbox"/> 12 Art. 13.030.04 <input type="checkbox"/> 14 Art. 13.030.05 <input type="checkbox"/> 16 Art. 13.030.06 <input type="checkbox"/> 18 Art. 13.030.07 <input type="checkbox"/> 20</p>
--	--	--	---



<p>H.230 mm. Art. 13.030.13 <input type="checkbox"/> 12 Art. 13.030.14 <input type="checkbox"/> 14 Art. 13.030.15 <input type="checkbox"/> 16</p>	<p>Martellato / Hammered H.230 mm. Art. 13.030.16 <input type="checkbox"/> 12 Art. 13.030.17 <input type="checkbox"/> 14 Art. 13.030.18 <input type="checkbox"/> 16</p>	<p>Tondo / Round H.230 mm. Art. 13.030.19 <input type="checkbox"/> 12 Art. 13.030.20 <input type="checkbox"/> 14 Art. 13.030.21 <input type="checkbox"/> 16</p>	<p>H.230 mm. Art. 13.031 <input type="checkbox"/> 14</p>	<p>Pallina Grande / Large Ball H.230 mm. Art. 13.032 <input type="checkbox"/> 14</p>
---	---	---	--	--

Tutte le parti di questo catalogo - foto comprese - sono di proprietà Euro-Fer. La riproduzione, anche parziale, è vietata in ogni forma e con ogni mezzo. / Every part of this catalogue - photos included - is Euro-Fer's property. All forms of copying are strictly prohibited.

Lancia forgiata a caldo / Hot forged spear

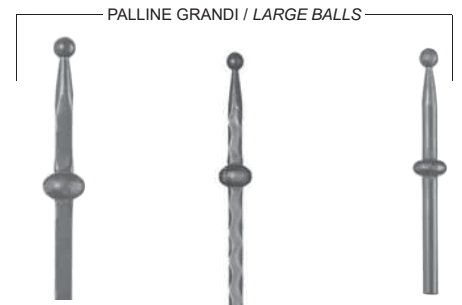

L.75 mm		L.75 mm	
Art. 13.032.04	□16 H.290	Art. 13.032.09	□12 H.270
Art. 13.032.06	□12 H.270	Art. 13.032.10	□14 H.280
Art. 13.032.07	□14 H.280	Art. 13.032.11	□16 H.290
Art. 13.032.08	□18 H.310	Art. 13.032.12	□18 H.310

Martellato / Hammered H.230 mm.		Tondo / Round H.230 mm.	
Art. 13.033	□14	Art. 13.033.03	□12
Art. 13.033.01	□16	Art. 13.033.04	□14
Art. 13.033.02	□12	Art. 13.033.05	□16
		Art. 13.033.06	Ø 12
		Art. 13.033.07	Ø 14
		Art. 13.033.08	Ø 16

H.230 mm.		Martellato / Hammered H.230 mm.		Tondo / Round H.230 mm.	
Art. 13.034	□14	Art. 13.034.03	□12	Art. 13.034.06	Ø 12
Art. 13.034.01	□16	Art. 13.034.04	□14	Art. 13.034.07	Ø 14
Art. 13.034.02	□12	Art. 13.034.05	□16	Art. 13.034.08	Ø 16

PALLINE GRANDI / LARGE BALLS



H.230 mm	
Art. 13.034.50	□12
Art. 13.035	□14

H.180 mm.	
Art. 13.035.01	□12
Art. 13.035.02	□14
Art. 13.035.03	□16

Martellato / Hammered H.180 mm.	
Art. 13.035.04	□12
Art. 13.035.05	□14
Art. 13.035.06	□16

Tondo / Round H.180 mm.	
Art. 13.035.07	Ø 12
Art. 13.035.08	Ø 14
Art. 13.035.09	Ø 16

H.230 mm.	
Art. 13.035.10	□12
Art. 13.035.11	□14
Art. 13.035.12	□16
Art. 13.035.13	□18

Martellato / Hammered H.230 mm.	
Art. 13.035.14	□12
Art. 13.035.15	□14
Art. 13.035.16	□16
Art. 13.035.17	□18

Tondo / Round H.230 mm.	
Art. 13.035.18	Ø 12
Art. 13.035.19	Ø 14
Art. 13.035.20	Ø 16
Art. 13.035.21	Ø 18

H.230 mm.	
Art. 13.035.22	□12
Art. 13.035.23	□14
Art. 13.035.24	□16
Art. 13.035.25	□18



H.250 mm.	
Art. 13.035.26	□14
Art. 13.035.27	□16

Martellato / Hammered H.250 mm.	
Art. 13.035.28	□14
Art. 13.035.29	□16

Tondo / Round H.250 mm.	
Art. 13.035.30	Ø 14
Art. 13.035.31	Ø 16

Fascetta inserita a caldo Hot-inserted clip H.250 mm.	
Art. 13.035.32	□14
Art. 13.035.33	□16

Fascetta inserita a caldo Hot-inserted clip Martellato / Hammered H.250 mm.	
Art. 13.035.34	□14
Art. 13.035.35	□16

Fascetta inserita a caldo Hot-inserted clip Tondo / Round H.250 mm.	
Art. 13.035.36	Ø 14
Art. 13.035.37	Ø 16

H.280 mm.	
Art. 13.035.38	□14
Art. 13.035.39	□16
Art. 13.035.40	□18

Martellato / Hammered H.280 mm.	
Art. 13.035.41	□14
Art. 13.035.42	□16
Art. 13.035.43	□18

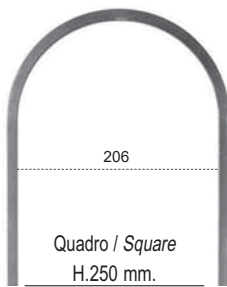
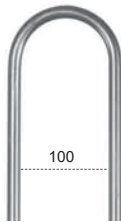

Tondo / Round H.280 mm.	
Art. 13.035.44	Ø 14
Art. 13.035.45	Ø 16
Art. 13.035.46	Ø 18

Tondo Lavorato Worked Round Bar H.280 mm.	
Art. 13.035.47	Ø 14
Art. 13.035.48	Ø 16
Art. 13.035.49	Ø 18

Tondo / Round H.250 mm.	
Art. 13.035.50	Ø 12
Art. 13.035.51	Ø 14

Quadro / Square H.250 mm.	
Art. 13.035.52	□12
Art. 13.035.53	□14

Quadro / Square H.250 mm.	
Art. 13.035.54	□12
Art. 13.035.55	□14

Tondo / Round H.250 mm.	
Art. 13.035.56	Ø 12
Art. 13.035.57	Ø 14

H.200 mm.	
Art. 13.035.58	□12
Art. 13.035.59	□14
Art. 13.035.60	□16
Art. 13.035.61	□18
Art. 13.035.62	□20

Martellato / Hammered H.200 mm.	
Art. 13.035.63	□12
Art. 13.035.64	□14
Art. 13.035.65	□16
Art. 13.035.66	□18
Art. 13.035.67	□20

Tondo / Round H.200 mm.	
Art. 13.035.68	Ø 12
Art. 13.035.69	Ø 14
Art. 13.035.70	Ø 16
Art. 13.035.71	Ø 18

Tutte le parti di questo catalogo - foto comprese - sono di proprietà Euro-Fer. La riproduzione, anche parziale, è vietata in ogni forma e con ogni mezzo. / Every part of this catalogue - photos included - is Euro-Fer's property. All forms of copying are strictly prohibited.



Pallina piccola / Small ball
Liscio / Smooth
H.200 mm
Art. 13.035.80 □ 12
Art. 13.035.81 □ 14
Art. 13.035.82 □ 16



Pallina piccola / Small ball
Martellato / Hammered
H.200 mm
Art. 13.035.85 □ 12
Art. 13.035.86 □ 14
Art. 13.035.87 □ 16

Modello mezza luna / Half moon model



Liscio / Smooth
H. 190 X L.120 mm
Art. 13.035.100
2 x ≠ 16 X 8 mm
Art. 13.035.101
2 x ≠ 12 X 6 mm



Schiacciata sullo spigolo / Ornament on the edge
H.200 mm
Art. 13.035.140 □ 12
Art. 13.035.141 □ 14
Art. 13.035.142 □ 16
Liscio / Smooth



Martellato / Hammered
H.200 mm
Art. 13.035.150 □ 12
Art. 13.035.151 □ 14
Art. 13.035.152 □ 16



Liscio / Smooth
H.200 mm
Art. 13.035.153 □ 12
Art. 13.035.154 □ 14
Art. 13.035.155 □ 16



Liscio / Smooth
H.200 mm
Art. 13.035.300
≠ 25 x 8 mm
Art. 13.035.301
≠ 30 x 8 mm



H.150 X L.40 mm.
Art. 13.036 □ 12



H.180 X L.45 mm.
Art. 13.037 □ 14



H.190 X L.50 mm.
Art. 13.038 □ 16



H.200 X L.55 mm.
Art. 13.039 □ 18



H.210 X L.62 mm.
Art. 13.040 □ 20



H.125 X L.60 mm.
Art. 13.041 Ø 13



H.155 X L.70 mm.
Art. 13.042 Ø 16



H.190 X L.90 mm.
Art. 13.043 Ø 16



H.130 X L.50 mm.
Art. 13.044 Ø 15



H.130 X L.53 mm.
Art. 13.045 Ø 13



H.160 X L.65 mm.
Art. 13.046 Ø 17



H.195 X L.75 mm.
Art. 13.047 Ø 17



H.110 X L.60 mm.
Art. 13.048 Ø 20

Fornite con inserto di plastica separato / Provided with separate plastic thread



H.135 X L.70 mm.
Art. 13.049 Ø 26



H.130 X L.70 mm.
Art. 13.050 Ø 20



H.140 X L.90 mm.
Art. 13.051 Ø 30

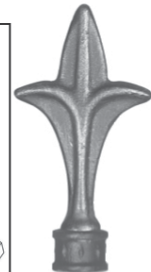
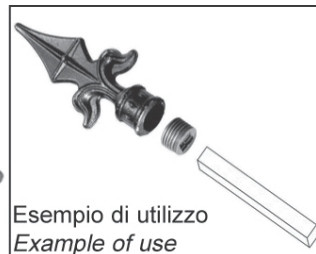

H.125 X L.58 mm.
Art. 13.051.01
Fuori Produzione
Out of Production

Art. 13.051.02
base Ø 26 mm.
foro □ 12,5 mm.

H.155 X L.70 mm.
Art. 13.051.03
Fuori Produzione
Out of Production

Art. 13.051.04
Fuori Produzione
Out of Production

H.125 X L.60 mm.
Art. 13.051.05
Fuori Produzione
Out of Production

Art. 13.051.06
base Ø 26 mm.
foro □ 12,5 mm.

H.155 X L.70 mm.
Art. 13.051.07
base Ø 30 mm.
foro Ø 16,5 mm.

Art. 13.051.08
base Ø 30 mm.
foro □ 14,5 mm.

H.130 X L.60 mm.
Art. 13.052 Ø12H.130 X L.60 mm.
Art. 13.052.01 Ø12H.130 X L.60 mm.
Art. 13.052.02
base Ø 12 mm.H.155 X L.70 mm.
Art. 13.053 Ø 17H.190 X L.95 mm.
Art. 13.054 Ø 20H.80 X L.45 mm.
Art. 13.055 Ø 20H.78 X L.45 mm.
Art. 13.055.F12 Ø 12H.125 X L.65 mm.
Art. 13.056 Ø 25H.140 X L.80 mm.
Art. 13.057 Ø 38H.120 X L.55 mm.
Art. 13.058 Ø 20H.135 X L.65 mm.
Art. 13.059 Ø 25H.125 X L.63 mm.
Art. 13.059.01 Ø 24
H.138 X L.67 mm.
Art. 13.059.02 Ø 25
H.163 X L.83 mm.
Art. 13.059.03 Ø 30H.115 X L.58 mm.
Art. 13.060 Ø 20H.115 X L.58 mm.
Art. 13.060.02
base Ø 21,5 mm.
H.140 X L.70 mm.
Art. 13.061.02
base Ø 26 mm.H.113 X L.57 mm.
Art. 13.060.F12 Ø 12H.140 X L.70 mm.
Art. 13.061 Ø 26H.70 X L.60 mm.
Art. 13.062 □ 12H.130 X L.60 mm.
Art. 13.063.01 □ 14H.140 X L.60 mm.
Art. 13.064 ≧ 14X 8H.125 mm.
Art. 13.064.01
base Ø 15 mm.
H.100 mm.
Art. 13.064.02
base Ø 12 mm.H.125 mm.
Art. 13.064.03
base Ø 15 mm.
H.100 mm.
Art. 13.064.04
base Ø 12 mm.H.120 X L.42 mm.
Art. 13.065 □ 12
H.140 X L.46 mm.
Art. 13.066 □ 14H.150 mm.
Art. 13.067 □ 14

Decorazioni con vetro colorato / Coloured glass decorations

H.125 mm. - base Ø 15 mm.
Art. 13.067.01 Rosso / Red
Art. 13.067.02 Azzurro Int. / Intense Azure
Art. 13.067.03 Verde Smeraldo / Green
Art. 13.067.04 Giallo Vivace / Vivid Yellow
Art. 13.067.06 Blu Oltremare / Dark BlueH.100 mm. - base Ø 12 mm.
Art. 13.067.07 Rosso / Red
Art. 13.067.09 Verde Smeraldo / GreenH.170 X L.52 mm.
Art. 13.068 □ 14H.150 X L.45 mm.
Art. 13.070 Ø 28H.150 X L.40 mm.
Art. 13.070.01
base □ 16H.125 X L.40 mm.
Art. 13.071 Ø 25H.135 X L.40 mm.
Art. 13.072 Ø 25H.160 X L.50 mm.
Art. 13.073 Ø 30H.190 X L.55 mm.
Art. 13.074 Ø 32H.175 X L.60 mm.
Art. 13.075 Ø 35H.195 X L.55 mm.
Art. 13.076 Ø 38

Tutte le parti di questo catalogo - foto comprese - sono di proprietà Euro-Fer. La riproduzione, anche parziale, è vietata in ogni forma e con ogni mezzo. / Every part of this catalogue - photos included - is Euro-Fer's property. All forms of copying are strictly prohibited.



H.125 X L.60 mm.
Art. 13.077 Ø 32



H.110 mm.
Art. 13.077.01
base Ø 25 mm.



H.110 mm.
Art. 13.077.02
base Ø 25 mm.



H.110 X L.60 mm.
Art. 13.077.04



H.125 X L.65 mm.
Art. 13.077.05



H.140 X L.70 mm.
Art. 13.077.06



H.140 X L.60 mm.
Art. 13.078 □ 15



H.130 X L.70 mm.
Art. 13.079 □ 20

H.125 mm.
Art. 13.077.03
base Ø 32 mm.



H.155 X L.65 mm.
Art. 13.080 Ø 16



H.190 mm.
Art. 13.080.01
base Ø 35 mm.



H.200 mm.
Art. 13.080.03
base Ø 32 mm.



H.150 mm.
Art. 13.080.07
base Ø 16 mm.



H.125 X L.45 mm.
Art. 13.083 Ø 25



H.140 X L.57 mm.
Art. 13.084 Ø 33



H.190 X L.68 mm.
Art. 13.085 Ø 40

H.142 mm.
Art. 13.080.02
base Ø 28 mm.

H.125 x L.50 mm
Art. 13.080.08 Ø 25 mm

H.160 mm.
Art. 13.080.04
base Ø 26 mm.

H.110 mm.
Art. 13.080.06
base Ø 18 mm.



H.133 mm.
Art. 13.085.01
base □ 20



H.260 X L.24 mm.
Art. 13.086 Ø 17



H.260 mm.
Art. 13.086.01
base Ø 50 mm.



H.150 mm.
Art. 13.086.03
base Ø 30 mm.



H.110 X L.36 mm.
Art. 13.086.04
base Ø 25 mm.



H.200 mm.
Art. 13.086.05 Ø 12
Art. 13.086.06 Ø 14
Art. 13.086.09 Ø 25



H.110 X L.27 mm.
Art. 13.087 Ø 27



H.130 x L.32 mm.
Art. 13.087.01 □ 30

H.180 mm.
Art. 13.086.02
base Ø 35 mm.



H.125 X L.32 mm.
Art. 13.088 Ø 32



H.160 X L.25 mm.
Art. 13.089 □ 25



H.120 mm.
Art. 13.089.01
base □ 18



H.150 X L.40 mm.
Art. 13.090 □ 40



H.150 mm.
Art. 13.090.01
base □ 40 mm.



H.125 mm.
Art. 13.090.03
base □ 25 mm.



H.125 X L.30 mm.
Art. 13.091
base □ 20 mm.
quadrello □ 10 mm.



H.125 X L.30 mm.
Art. 13.092 □ 20

H.135 mm.
Art. 13.090.02
base □ 32 mm.

H.100 mm.
Art. 13.090.04
base □ 20 mm.

Tutte le parti di questo catalogo - foto comprese - sono di proprietà Euro-Fer. La riproduzione, anche parziale, è vietata in ogni forma e con ogni mezzo. / Every part of this catalogue - photos included - is Euro-Fer's property. All forms of copying are strictly prohibited.



H.190 X L.50 mm.
Art. 13.094 □ 40



H.128 mm.
Art. 13.094.01
base □ 28



H.95 X L.27 mm.
Art. 13.095 □ 12



H.125 X L.40 mm.
Art. 13.096 Ø 18



H.60 mm.
Art. 13.097 □ 24



H.60 X L.30 mm.
Art. 13.097.F12 Ø 12



H.85 mm
Art. 13.097.01 Ø 20
H.50 mm
Art. 13.097.03 Ø 12



H.150 mm.
Art. 13.098.01
base Ø 33
H.120 mm.
Art. 13.098.02
base Ø 30



H.210 X L.75 mm.
Art. 13.099 Ø 19

H.160 X L.40 mm.
Art. 13.093 □ 32



H.120 mm.
Art. 13.099.01
base □ 25



H.160 X L.90 mm.
Art. 13.100 Ø 16



H.165 X L.70 mm.
Art. 13.101 Ø 21



H.140 X L.50 mm.
Art. 13.102 Ø 13



H.180 X L.60 mm.
Art. 13.103 Ø 15



H.160 X L.100 mm.
Art. 13.104 □ 20



H.160 X L.70 mm.
Art. 13.105 Ø 25



H.135 X L.60 mm.
Art. 13.105.03
base Ø 12



H.110 mm.
Art. 13.106.01 Ø 12

H.155 mm.
Art. 13.099.02
base □ 30
H.195 mm
Art. 13.099.03
base □ 35



H.145 X L.80 mm.
Art. 13.107 □ 15



H.145 X L.80 mm.
Art. 13.107.01
base □ 15



H.145 X L.80 mm.
Art. 13.108 Ø 30



H.170 X L.85 mm.
Art. 13.109 Ø 50



H.235 X L.80 mm.
Art. 13.110 Ø 50



H.155 X L.60 mm.
Art. 13.110.01
base Ø 24



H.180 X L.70 mm.
Art. 13.110.03
base Ø 27



H.210 X L.80 mm.
Art. 13.110.04
base Ø 30



H.293 X L.75 mm.
Art. 13.111 □ 26



H.210 mm.
Art. 13.111.01 Ø 32



H.180 X 60 mm.
Art. 13.112 Ø 30



H.155 X L.75 mm.
Art. 13.112.01
base Ø 24



H.205 X 70 mm.
Art. 13.113 Ø 35



H.175 mm.
Art. 13.113.01
base Ø 28 mm.



H.215 x L.65 mm
Art. 13.113.02 Ø 18



H.270 X L.70 mm.
Art. 13.114 □ 20



H.260 mm.
Art. 13.114.01
base □ 33 mm.
H.195 mm.
Art. 13.114.02
base Ø 18 mm.



H.135 X L.48 mm.
Art. 13.115 Ø 29



H.165 X L.53 mm.
Art. 13.116 Ø 29



H.180 X L.55 mm.
Art. 13.117 Ø 29



H.170 X L.58 mm.
Art. 13.117.01 Ø 30



H.205 X L.62 mm.
Art. 13.118 Ø 35



H.243 X L.72 mm.
Art. 13.119 Ø 40



H.95 X L.40 mm.
Art. 13.120
base ≙ 12 X 4



H.140 X L.55 mm.
Art. 13.121
base ≙ 15 X 4



H.170 X L.60 mm.
Art. 13.122
base ≙ 20 X 8



H.180 X L.55 mm.
Art. 13.123 Ø 37



H.200 X L.55 mm.
Art. 13.124 Ø 35



H.190 X L.55 mm.
Art. 13.125 Ø 30



H.130 X L.47 mm.
Art. 13.126 Ø 33



H.130 X L.33 mm.
Art. 13.127 Ø 30



H.135 X L.30 mm.
Art. 13.128 □ 30



H.145 mm.
Art. 13.129 □ 25
Art. 13.130 □ 30



H.155 mm
Liscio / Smooth
Art. 13.131 □ 35
Art. 13.132 □ 40



H.155 mm
Liscio / Smooth
Art. 13.131.01 □ 50



H.115 X L.30 mm.
Art. 13.132.01 □ 8



H.220 X L.30 mm.
Art. 13.132.02 □ 12



H.39 X L.40 mm.
Art. 13.133



H.67 X L.40 mm.
Art. 13.134



Borchie Svasate /
Countersunk Ironstud
H.39 x L.40 mm
Art. 13.135.B Ø 12,5
Art. 13.136.B Ø 14,5
Art. 13.137.B Ø 16,5



H.36 x L.37 mm
Art. 13.135.E Ø 12,5
Art. 13.136.E Ø 14,5
Art. 13.137.E Ø 16,5

H.39 X L.40 mm.
Art. 13.135 Ø 12,5
Art. 13.136 Ø 14,5
Art. 13.137 Ø 16,5

Rullate / Rolled
H.39 x L.40 mm
Art. 13.135.R Ø 12,5
Art. 13.136.R Ø 14,5
Art. 13.137.R Ø 16,5



H.63 x L.37 mm
Art. 13.138.E Ø 12,5
Art. 13.139.E Ø 14,5
Art. 13.140.E Ø 16,5

H.67 X L.40 mm.
Art. 13.138 Ø 12,5
Art. 13.139 Ø 14,5
Art. 13.140 Ø 16,5

H.63 x L.38 mm
Art. 13.140.RE Ø 16,5

Rullate / Rolled
H.67 x L.40 mm
Art. 13.138.R Ø 12,5
Art. 13.139.R Ø 14,5
Art. 13.140.R Ø 16,5

Nuove Borchie in Tubo / New Studs in Tube



H.39 x L. 40 mm
Art. TB.13.135 Ø 12,5
Art. TB.13.136 Ø 14,5
Art. TB.13.137 Ø 16,5



H.67 x L. 40 mm
Art. TB.13.138 Ø 12,5
Art. TB.13.139 Ø 14,5
Art. TB.13.140 Ø 16,5



H.39 x L. 40 mm
Art. TB.13.141 □ 12,5



H.67 x L. 40 mm
Art. TB.13.142 □ 12,5

H.44 x L. 45 mm
Art. TB.13.150 □ 14,5
Art. TB.13.150.01 □ 16,5

H.67 x L. 45 mm
Art. TB.13.152 □ 14,5
Art. TB.13.153 □ 16,5

**Attenzione: Sezione Cava! Eventualmente, avvisare lo zincatore.
Be Careful: Hole Section! Eventually, inform the galvanizer.**

Articoli in ferro fuso / Cast steel items
Senza inserto / Without insert



H.65 x L.40 mm
Art. CS.13.142 □ 12,5



H.67 x L.45 mm
Art. CS.13.151 □ 12,5
Art. CS.13.152 □ 14,5
Art. CS.13.153 □ 16,5



H.39 x L.40 mm
Art. 13.141 □ 12,5

Rullate / Rolled
H.39 x L.40 mm
Art. 13.141.R □ 12,5



H.67 X L.40 mm.
Art. 13.142 □ 12,5

Rullate / Rolled
H.67 X L.40 mm.
Art. 13.142.R □ 12,5



H.44 X L.45 mm.
Art. 13.143

Rullate / Rolled
H.44 X L.45 mm.
Art. 13.143.R



H.67 X L.45 mm.
Art. 13.144

Rullate / Rolled
H.67 X L.45 mm.
Art. 13.144.R



H.44 X L. 45 mm.
Art. 13.145 Ø 14,5
Art. 13.146 Ø 16,5
Art. 13.146.01 Ø 18,5
Art. 13.146.02 Ø 20,5

Rullate / Rolled
H.44 X L. 45 mm.
Art. 13.145.R Ø 14,5
Art. 13.146.R Ø 16,5
Art. 13.146.01.R Ø 18,5



H.67 X L. 45 mm.
Art. 13.147 Ø 14,5
Art. 13.148 Ø 16,5
Art. 13.148.01 Ø 18,5
Art. 13.148.02 Ø 20,5



H.44 X L.45 mm.
Art. 13.149 □ 12,5
Art. 13.150 □ 14,5
Art. 13.150.01 □ 16,5

Rullate / Rolled

H.44 X L.45 mm.
Art. 13.149.R □ 12,5
Art. 13.150.R □ 14,5
Art. 13.150.01.R □ 16,5



H.67 X L.45 mm.
Art. 13.151 □ 12,5
Art. 13.152 □ 14,5
Art. 13.153 □ 16,5

Rullate / Rolled

H.67 X L.45 mm.
Art. 13.151.R □ 12,5
Art. 13.152.R □ 14,5
Art. 13.153.R □ 16,5



H.47 X L.50 mm.
Art. 13.154



H.80 X L.50 mm.
Art. 13.155



H.47 X L.50 mm.
Art. 13.156 Ø 16,5
Art. 13.157 Ø 18,5
Art. 13.158 Ø 20,5
Art. 13.158.01 Ø 22,5



H.80 X L.50 mm.
Art. 13.159 Ø 16,5
Art. 13.160 Ø 18,5
Art. 13.161 Ø 20,5
Art. 13.161.01 Ø 22,5



H.47 X L.50 mm.
Art. 13.162 □ 14,5
Art. 13.163 □ 16,5



H.80 X L.50 mm.
Art. 13.164 □ 14,5
Art. 13.165 □ 16,5

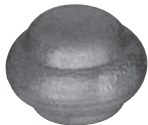

H.25 X L.35 mm.
Art. 13.166

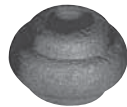

H.25 X L.35 mm.
Art. 13.167 Ø 12,5
Art. 13.167.01 Ø 14,5
Art. 13.167.02 Ø 16,5

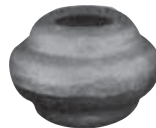

H.25 X L.35 mm.
Art. 13.167.03 □ 12,5
Art. 13.167.04 □ 14,5

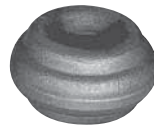

H.22 X L.40 mm.
Art. 13.168 Ø 14,5
Art. 13.168.01 Ø 16,5
Art. 13.168.02 Ø 12,5



H.35 X L.55 mm.
Art. 13.168.03 Ø 18,5
Art. 13.168.04 Ø 20,5
Art. 13.168.05 Ø 25,5
Art. 13.168.06 Ø 30,5



H.35 X L.55 mm.
Art. 13.168.07 □ 20,5
Art. 13.168.08 □ 25,5
non in produzione
not in production

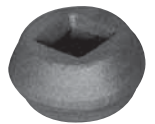

H.22 X L.40 mm.
Art. 13.169 □ 14,5
Art. 13.169.01 □ 16,5
Art. 13.169.02 □ 12,5



H.22 X L.33 mm.
Art. 13.169.03 □ 12,5
H.22 X L.38 mm.
Art. 13.169.05 □ 14,5
Art. 13.169.06 □ 16,5



H.35 X L.55 mm.
Art. 13.169.07 □ 20,5
Art. 13.169.08 □ 22,5
Art. 13.169.09 □ 25,5



H.32 X L.47 mm.
Art. 13.169.10 □ 12,5
Art. 13.169.11 □ 14,5
Art. 13.169.12 □ 16,5
Art. 13.169.13 □ 18,5



H.60 X L.35 mm.
Art. 13.170.R



H.30 X L.35 mm.
Art. 13.170.01.R



H.60 X L.35 mm.
Art. 13.171.R Ø 14,5
Art. 13.172.R Ø 16,5
Art. 13.173.R Ø 18,5
Art. 13.173.01.R Ø 12,5
Art. 13.173.02.R □ 12



H.30 X L.35 mm.
Art. 13.173.03.R Ø 12,5
Art. 13.173.04.R Ø 14,5
Art. 13.173.05.R Ø 16,5
Art. 13.173.06.R Ø 18,5
Art. 13.173.07.R □ 12

BORCHIE TORNITE / TURNED BUSHES



H.24 X L.35 mm.
Art. 13.173.08 Ø 12,5
Art. 13.173.09 Ø 14,5
Art. 13.173.10 Ø 16,5



H.20 X L.40 mm.
Art. 13.173.11 Ø 12,5
Art. 13.173.12 Ø 14,5
Art. 13.173.13 Ø 16,5



H.25 X L.40 mm.
Art. 13.173.14 Ø 25,5



H.26 X L.35 mm.
Art. 13.173.15 Ø 12,5
Art. 13.173.16 Ø 14,5
Art. 13.173.17 Ø 16,5
Art. 13.173.18 Ø 18,5



H.60 X L.35 mm.
Art. 13.173.19 Ø 12,5
Art. 13.173.20 Ø 14,5
Art. 13.173.21 Ø 16,5
Art. 13.173.22 Ø 18,5



H.60 X L.35 mm.
Art. 13.173.23 Ø 14,5



H.25 X L.35 mm.
Art. 13.173.24 Ø 14,5



H.25 X L.35 mm.
Art. 13.173.25 Ø 14,5



H.24 X L.35 mm.
Art. 13.173.26 Ø 14,5



H.23 X L.35 mm.
Art. 13.173.27 Ø 14,5



H.7 X L.15 mm.
Art. 13.173.28
foro Ø 8



H.55 X L.40 mm.
Art. 13.175 Ø 14,5
Art. 13.175.01 Ø 16,5
Art. 13.175.02 Ø 12,5
Art. 13.175.03 □ 12



H.52 X L.69 mm.
Art. 13.176



H.80 X L.69 mm.
Art. 13.177



H.52 X L.69 mm.
Art. 13.178 Ø 27,5
Art. 13.179 Ø 30,5
Art. 13.180 Ø 35,5
Art. 13.181 Ø 40,5
Art. 13.181.01 □ 25,5
Art. 13.181.02 □ 30,5



H.80 X L.69 mm.
Art. 13.182 Ø 27,5
Art. 13.183 Ø 30,5
Art. 13.184 Ø 35,5
Art. 13.185 Ø 40,5
Art. 13.185.01 □ 25,5
Art. 13.185.02 □ 30,5



H.55 X L.35 mm.
Art. 13.185.03



H.55 X L.35 mm.
Art. 13.185.04 Ø 12,5
Art. 13.185.05 Ø 14,5
Art. 13.185.06 Ø 16,5
Art. 13.185.07 Ø 18,5



H.55 X L.35 mm.
Art. 13.185.08 □ 12,5
Art. 13.185.09 □ 14,5
non in produzione
not in production



H.75 X L.49 mm.
Art. 13.185.10



H.75 X L.49 mm.
Art. 13.185.11 Ø 16,5
Art. 13.185.12 Ø 18,5
Art. 13.185.13 Ø 20,5
Art. 13.185.14 Ø 22,5



H.75 X L.49 mm.
Art. 13.185.15 □ 14,5
Art. 13.185.16 □ 16,5



H.70 X L.64 mm.
Art. 13.185.17 □ 16,5



H.55 x L.60 mm
Art. 13.185.18 base 37 Senza foro / Without hole
Art. 13.185.19 Ø 20,5
Art. 13.185.20 Ø 22,5
Art. 13.185.21 Ø 25,5
Art. 13.185.22 Ø 27,5
Art. 13.185.23 □ 14,5
Art. 13.185.24 □ 16,5



H.110 x L.40 mm
Art. 13.185.25 Ø 16,5



H.70 x L.45 mm
Art. 13.185.26 Ø 20



H.135 mm
Art. 13.185.27 Ø 14,5
H.150 mm
Art. 13.185.28 Ø 16,5



H.70 mm
Art. 13.185.30 Ø 14,5
H.80 mm
Art. 13.185.31 Ø 16,5



H.55 X L.47 mm.
Art. 13.186



H.55 X L.47 mm.
Art. 13.187 Ø 14,5
Art. 13.188 Ø 16,5
Art. 13.188.01 Ø 18,5
Art. 13.188.02 Ø 12,5
Art. 13.189 □ 14,5
Art. 13.190 □ 16,5
Art. 13.190.01 □ 12,5



H.125 X L.35 mm.
Art. 13.190.02 S.F.
Art. 13.190.03 Ø 12,5
Art. 13.190.04 Ø 14,5
Art. 13.190.05 Ø 16,5
Art. 13.190.06 Ø 18,5
Art. 13.190.07 □ 14,5
Art. 13.190.08 □ 16,5



H.120 X L.28 mm.
Art. 13.191 S.F.
Art. 13.192 Ø 14,5
Art. 13.193 Ø 16,5
Art. 13.193.01 Ø 12,5
Art. 13.193.02 □ 12,5

BORCHIE, LANCE E PIASTRE STUDS, SPEARS AND PLATES

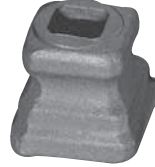

H.70 X L.35 mm.		H.64 X L.33 mm.	
Art. 13.194	S.F.	Art. 13.196	S.F.
Art. 13.195	Ø 16,5	Art. 13.197	Ø 14,5
Art. 13.195.01	Ø 18,5	Art. 13.198	Ø 16,5
Art. 13.195.02	Ø 14,5	Art. 13.198.01	Ø 12,5
Art. 13.195.03	Ø 12,5	Art. 13.198.02	□ 12,5
Art. 13.195.04	□ 14,5		
Art. 13.195.05	□ 16,5		

H.50 X L.45 mm.
Art. 13.199

H.90 X L.45 mm.
Art. 13.200

H.50 X L.45 mm.	
Art. 13.201	□ 14,5
Art. 13.202	□ 16,5
Art. 13.202.01	□ 18,5
Art. 13.202.02	Ø 18,5
Art. 13.202.03	Ø 20,5
Art. 13.202.04	Ø 22,5
Art. 13.202.05	Ø 25,5

H.90 X L.45 mm.	
Art. 13.203	Ø 14
Art. 13.204	Ø 18,5
Art. 13.204.01	Ø 20,5
Art. 13.204.02	Ø 22,5
Art. 13.204.03	Ø 25,5
Art. 13.205	□ 14,5
Art. 13.206	□ 16,5
Art. 13.206.01	□ 18,5

H.40 X L.40 mm.
Art. 13.207

H.68 X L.40 mm.
Art. 13.208



H.40 X L.40 mm.		H.68 X L.40 mm.	
Art. 13.209	□ 12,5	Art. 13.211	□ 12,5
Art. 13.210	□ 14,5	Art. 13.212	□ 14,5
Art. 13.210.01	□ 16,5	Art. 13.213	□ 16,5
Art. 13.210.02	Ø 16,5	Art. 13.213.01	Ø 16,5
Art. 13.210.03	Ø 18,5	Art. 13.213.02	Ø 18,5
Art. 13.210.04	Ø 20,5	Art. 13.213.03	Ø 20,5
Art. 13.210.05	Ø 22,5	Art. 13.213.04	Ø 22,5

H.45 X L.40 mm.	
Art. 13.213.05	□ 12,5
Art. 13.213.06	□ 14,5

H.25 X L.40 mm.	
Art. 13.213.07	□ 12,5
Art. 13.213.08	□ 14,5

H.45 X L.40 mm.	
Art. 13.213.10	Ø 14,5
Art. 13.213.11	Ø 16,5

H.25 X L.40 mm.	
Art. 13.213.12	Ø 12,5
Art. 13.213.13	Ø 14,5
Art. 13.213.14	Ø 16,5

BORCHIE IN TUBO DI FERRO / TUBULAR IRON BUSHES



H.90 X L.40 mm.
Art. 13.213.16 Ø 14,5

H.45 X L.30 mm.
Art. 13.213.19 Ø 12,5
Art. 13.213.20 Ø 14,5

H.15 X L.30 mm
Art. 13.213.22 Ø 14,5

H.68 X L. 30 mm
Art. TB.13.213.17 Ø 12,5
Art. TB.13.213.18 Ø 14,5

H.20 x L. 30 mm
Art. TB.13.213.23 Ø 12,5



H.118 x L. 40 mm
Art. TB.13.213.25 Ø 14,5
Art. TB.13.213.26 Ø 16,5

H.140 x L. 30 mm
Art. TB.13.213.30 Ø 12,5
Art. TB.13.213.31 Ø 14,5

H.118 x L. 30 mm
Art. TB.13.213.34 Ø 12,5
Art. TB.13.213.35 Ø 14,5

H.83 x L. 30 mm
Art. TB.13.213.38 Ø 12,5
Art. TB.13.213.39 Ø 14,5

H.65 x L. 30 mm
Art. TB.13.213.44 Ø 12,5
Art. TB.13.213.45 Ø 14,5



H.90 X L. base 40 mm.
Art. 13.214



H.90 X L. base 40 mm.
Art. 13.214.01



H.120 X L. base 55 mm.
Art. 13.216

H.190 X L. base 90 mm.
Art. 13.216.01

H.150 X L. base 70 mm.
Art. 13.216.02

H.85 X L. base 43 mm.
Art. 13.216.03

H.55 X L. base 28 mm.
Art. 13.216.04



H.90 mm.
Art. 13.217
base Ø 50 mm.



H.180 mm.
Art. 13.218
base Ø 100 mm.



H.57 mm.
Art. 13.218.01
base □ 16 mm.



H.80 mm.
Art. 13.219
base 28 mm.



H.100 mm.
Art. 13.220
base 50 mm.



H.180 mm.
Art. 13.221
base 100 mm.



H.140 mm. - sfera Ø 110
Art. 13.221.01
base Ø 90 mm.
H.125 mm. - sfera Ø 90
Art. 13.221.02
base Ø 70 mm.

Tutte le parti di questo catalogo - foto comprese - sono di proprietà Euro-Fer. La riproduzione, anche parziale, è vietata in ogni forma e con ogni mezzo. / Every part of this catalogue - photos included - is Euro-Fer's property. All forms of copying are strictly prohibited.



H.100 mm. - sfera Ø 70
Art. 13.221.03
base Ø 55 mm.



H.200 mm.
Art. 13.221.05
base Ø 50 mm.



H.100 mm.
Art. 13.222
base Ø 50 mm.
H.180 mm.
Art. 13.222.01
base Ø 100 mm.

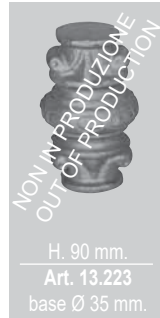

H. 90 mm.
Art. 13.223
base Ø 35 mm.



H.90 X L.35 mm.
Art. 13.223.01 Ø 16,5
Art. 13.223.02 Ø 18,5
Art. 13.223.03 Ø 22,5



H.90 X L.35 mm.
Art. 13.223.04 □ 14,5
Art. 13.223.05 □ 16,5



H.135 X L.36 mm.

Art. 13.223.06 Senza foro/Without hole
Art. 13.223.07 Con foro/With hole Ø 12,5
Art. 13.223.08 Con foro/With hole Ø 14,5
Art. 13.223.09 Con foro/With hole Ø 16,5
Art. 13.223.10 Con foro/With hole □ 12,5



H.75 X L.36 mm.

Art. 13.223.11 Senza foro/Without hole
Art. 13.223.12 Con foro/With hole Ø 12,5
Art. 13.223.13 Con foro/With hole Ø 14,5
Art. 13.223.14 Con foro/With hole Ø 16,5
Art. 13.223.15 Con foro/With hole □ 12,5



H.48 X L.38 mm.

Art. 13.223.16 Senza foro/Without hole
Art. 13.223.17 Con foro/With hole Ø 12,5
Art. 13.223.18 Con foro/With hole Ø 14,5
Art. 13.223.19 Con foro/With hole Ø 16,5
Art. 13.223.20 Con foro/With hole □ 12,5



H.96 X L.38 mm.

Art. 13.223.21 Senza foro/Without hole
Art. 13.223.22 Con foro/With hole Ø 12,5
Art. 13.223.23 Con foro/With hole Ø 14,5
Art. 13.223.24 Con foro/With hole Ø 16,5
Art. 13.223.25 Con foro/With hole □ 12,5



H.40 X L.30 mm.
Art. 13.223.26 Ø 12,5
Art. 13.223.27 Ø 14,5
Art. 13.223.28 □ 12,5



H.90 mm.
Art. 13.224.01
base Ø 40 mm.
H.65 mm.
Art. 13.224.02
base Ø 27 mm.



H.70 X L.30 mm.
Art. 13.224.03
base □ 23 mm.



H.60 X L.43 mm.
Art. 13.225



H.50 X L.35 mm.
Art. 13.226



H.130 mm.
Art. 13.227
Ø 75 mm.



H.120 mm.
Art. 13.228
Ø 75 mm.



H.155 X L.60 mm.
Art. 13.228.01
base Ø 35 mm.



H.120 mm.
Art. 13.229
Ø 75 mm.



H.90 X L.50 mm.
Art. 13.229.01
base Ø 33 mm.



H.100 mm.
Art. 13.230
Ø 55 mm.



H.155 X L.50 mm.
Art. 13.230.01
base Ø 22 mm.



H.130 mm.
Art. 13.231
Ø 60 mm.



H.90 mm.
Art. 13.232
Ø 50 mm.



H.100 mm.
Art. 13.233
Ø 55 mm.



H.75 X L.30 mm.
Art. 13.233.01



H.50 X L.30 mm.
Art. 13.234



H.65 X L.35 mm.
Art. 13.235



H.60 mm.
Art. 13.235.01
base □ 25 mm.
H.85 mm.
Art. 13.235.02
base □ 40 mm.

H.150 mm.
Art. 13.235.04
base □ 80 mm.
H.200 mm.
Art. 13.235.05
base □ 100 mm.



H.60 mm.
Art. 13.235.06
base Ø 27 mm.
H.85 mm.
Art. 13.235.07
base Ø 42 mm.
H.125 mm.
Art. 13.235.08
base Ø 48 mm.

H.150 mm.
Art. 13.235.09
base Ø 60 mm.
H.200 mm.
Art. 13.235.10
base Ø 90 mm.



H.150 mm.
Art. 13.235.11
base □ 100 mm.
H.120 mm.
Art. 13.235.12
base □ 80 mm.
H.105 mm.
Art. 13.235.13
base □ 60 mm.

H.75 mm.
Art. 13.235.14
base □ 40 mm.
H.45 mm.
Art. 13.235.15
base □ 25 mm.



H.45 mm.
Art. 13.236
Ø 30 mm.
H.65 mm.
Art. 13.237
Ø 50 mm.

H.70 mm.
Art. 13.238
Ø 55 mm.
H.80 mm.
Art. 13.239
Ø 65 mm.

Sfere Lisce / Smooth Spheres

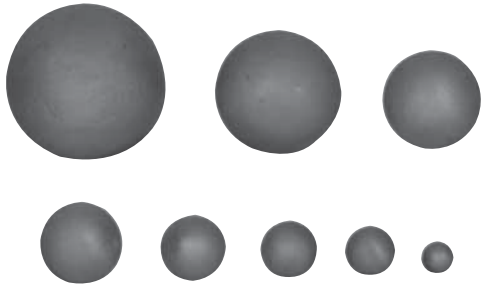

- Art. 13.240 Ø 15 mm.
- Art. 13.241 Ø 20 mm.
- Art. 13.242 Ø 25 mm.
- Art. 13.243 Ø 30 mm.
- Art. 13.244 Ø 35 mm.
- Art. 13.245 Ø 40 mm.
- Art. 13.246 Ø 50 mm.
- Art. 13.247 Ø 60 mm.
- Art. 13.248 Ø 70 mm.
- Art. 13.249 Ø 80 mm.
- Art. 13.250 Ø 90 mm.
- Art. 13.251 Ø 100 mm.
- Art. 13.251.01 Ø 120 mm.

Sfere Vuote in lamiera / Hollow Spheres in Iron Sheet

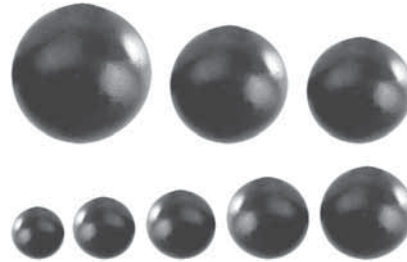

- Art. 13.251.30 Ø 30 mm.
- Art. 13.251.35 Ø 35 mm.
- Art. 13.251.40 Ø 40 mm.
- Art. 13.251.50 Ø 50 mm.
- Art. 13.251.60 Ø 60 mm.
- Art. 13.251.70 Ø 70 mm.
- Art. 13.251.80 Ø 80 mm.
- Art. 13.251.90 Ø 90 mm.
- Art. 13.251.100 Ø 100 mm.
- Art. 13.251.120 Ø 120 mm.
- Art. 13.251.150 Ø 150 mm.
- Art. 13.251.200 Ø 200 mm.

Si raccomanda di zincare a caldo le sfere vuote in lamiera solo dopo averle forate
It's recommended to perforate the Hollow Spheres before the hot galvanization

Sfere Schiacciate / Crushed Spheres

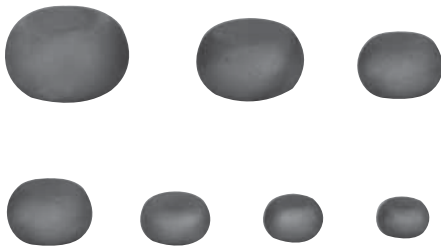

- H.50 X L.80 mm.
Art. 13.252
- H.40 X L.70 mm.
Art. 13.253
- H.35 X L.55 mm.
Art. 13.254
- H.28 X L.45 mm.
Art. 13.255
- H.26 X L.40 mm.
Art. 13.256
- H.22 X L.35 mm.
Art. 13.257

Sfere Forgiate Diamantate / Diamond Forged Spheres

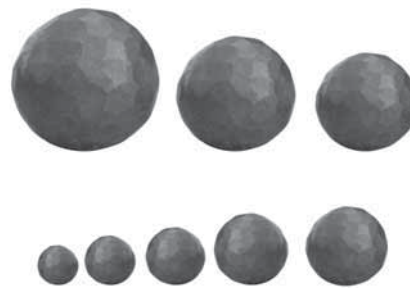

- Art. 13.252.20 Ø 20 mm.
- Art. 13.252.25 Ø 25 mm.
- Art. 13.252.30 Ø 30 mm.
- Art. 13.252.35 Ø 35 mm.
- Art. 13.252.40 Ø 40 mm.
- Art. 13.252.50 Ø 50 mm.
- Art. 13.252.60 Ø 60 mm.
- Art. 13.252.70 Ø 70 mm.
- Art. 13.252.80 Ø 80 mm.
- Art. 13.252.90 Ø 90 mm.
- Art. 13.252.100 Ø 100 mm.
- Art. 13.252.120 Ø 120 mm.
- Art. 13.252.150 Ø 150 mm.

Sfere Forgiate / Forged Spheres

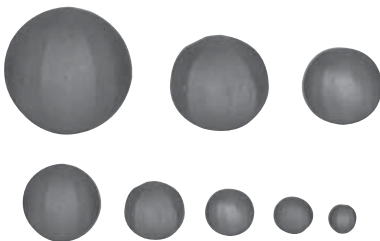

- Art. 13.258 Ø 20 mm.
- Art. 13.259 Ø 25 mm.
- Art. 13.260 Ø 30 mm.
- Art. 13.261 Ø 35 mm.
- Art. 13.262 Ø 40 mm.
- Art. 13.263 Ø 50 mm.
- Art. 13.264 Ø 60 mm.
- Art. 13.265 Ø 70 mm.
- Art. 13.266 Ø 80 mm.
- Art. 13.267 Ø 90 mm.
- Art. 13.268 Ø 100 mm.

Sfere Piene Forate / Holed Solid Spheres

foro / hole

foro passante / passing hole

Ø 25 mm.
Art. 13.242.F12
foro / hole Ø 12,5 mm.
Art. 13.242.F12H
foro passante / passing hole Ø 12,5 mm.

Ø 35 mm.
Art. 13.244.F12
foro / hole Ø 12,5 mm.
Art. 13.244.F12H
foro passante / passing hole Ø 12,5 mm.

Ø 30 mm.
Art. 13.243.F12
foro / hole Ø 12,5 mm.
Art. 13.243.F12H
foro passante / passing hole Ø 12,5 mm.

Art. 13.244.F14
foro / hole Ø 14,5 mm.
Art. 13.244.F14H
foro passante / passing hole Ø 14,5 mm.

Art. 13.244.F16
foro / hole Ø 16,5 mm.
Art. 13.244.F16H
foro passante / passing hole Ø 16,5 mm.

Mezze sfere vuote in lamiera / Half hollow spheres in iron sheet



- Spessore / Thickness 3 mm
- Art. 13.251.40H Ø 40 mm
 - Art. 13.251.50H Ø 50 mm
 - Art. 13.251.60H Ø 60 mm
 - Art. 13.251.70H Ø 70 mm
 - Art. 13.251.80H Ø 80 mm
 - Art. 13.251.90H Ø 90 mm
 - Art. 13.251.100H Ø 100 mm
 - Art. 13.251.120H Ø 120 mm
 - Art. 13.251.150H Ø 150 mm
 - Art. 13.251.200H Ø 200 mm.

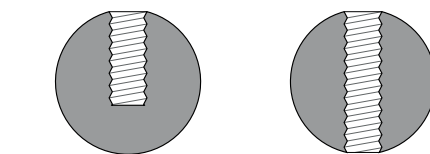

Sfere Piene Forate e Filettate / Solid Spheres with Threaded Hole

- Art. 13.268.50 Ø 12 mm. Filetto / Threaded M6 cieco
- Art. 13.268.51 Ø 12 mm. Filetto / Threaded M6 passante / passing
- Art. 13.268.60 Ø 16 mm. Filetto / Threaded M8 cieco
- Art. 13.268.61 Ø 16 mm. Filetto / Threaded M8 passante / passing
- Art. 13.268.65 Ø 20 mm. Filetto / Threaded M10 cieco
- Art. 13.268.66 Ø 20 mm. Filetto / Threaded M10 passante / passing



Pomoli in Ottone / Brass Knobs



H.55 X L.42 mm.
Art. 13.271
base 30 mm.

Filettato MA 10
Threaded MA 10



H.80 X L.55 mm.
Art. 13.272
base 42 mm.

Filettato MA 10
Threaded MA 10



H.100 X L.55 mm.
Art. 13.273
base 44 mm.

Filettato MA 12
Threaded MA 12



H.100 X L.60 mm

Art. 13.273.01
foro Ø 25,5 mm
base 30 mm
Filettato MA 10
Threaded MA 10

Pomoli in cristallo / Crystal Knobs



H.100 X L.65 mm.
Art. 13.273.05
Ø foro 35,5 mm.
base 50 mm.

Fissaggio con granello / Fastening with dowel



H.40 X L.25 mm.
Art. 13.273.09
base 18 mm.

Filettato MA 4
With Threaded MA 4



H.60 mm.
Art. 13.274 Ø 12,5 mm. L.30
Art. 13.275 Ø 14,5 mm. L.32
Art. 13.276 Ø 16,5 mm. L.33
Art. 13.277 Ø 18,5 mm. L.35



H.60 mm.
Art. 13.278 Ø 12,5 mm. L.29
Art. 13.279 Ø 14,5 mm. L.31
Art. 13.280 Ø 16,5 mm. L.33
Art. 13.281 Ø 18,5 mm. L.36



H.40 X L.25 mm.
Art. 13.282 Ø 12,5 mm.
Art. 13.283 Ø 14,5 mm.
Art. 13.284 Ø 16,5 mm.
Art. 13.285 Ø 18,5 mm.



H.26 mm.
Art. 13.286 Ø 12,5 mm. L.30
Art. 13.287 Ø 14,5 mm. L.32



H.26 mm.
Art. 13.290 Ø 12,5 mm. L.29
Art. 13.291 Ø 14,5 mm. L.31

Fissaggio con granello / Fastening with dowel



H.26 X L.30 mm.
Art. 13.293.01
Ø foro 12,5 mm.
H.26 X L.32 mm.
Art. 13.293.02
Ø foro 14,5 mm.
H.26 X L.33 mm.
Art. 13.293.03
Ø foro 16,5 mm.
H.26 X L.35 mm.
Art. 13.293.04
Ø foro 18,5 mm.



H.60 X L.32 mm.
Art. 13.293.06
Ø foro 14,5 mm.
H.60 X L.33 mm.
Art. 13.293.07
Ø foro 16,5 mm.



H.26 X L.29 mm.
Art. 13.293.09
Ø foro 12,5 mm.
H.26 X L.31 mm.
Art. 13.293.10
Ø foro 14,5 mm.
H.26 X L.33 mm.
Art. 13.293.11
Ø foro 16,5 mm.
H.26 X L.36 mm.
Art. 13.293.12
Ø foro 18,5 mm.



H.60 X L.29 mm.
Art. 13.293.13
Ø foro 12,5 mm.
H.60 X L.33 mm.
Art. 13.293.15
Ø foro 16,5 mm.
H.60 X L.36 mm.
Art. 13.293.16
Ø foro 18,5 mm.



H.25 X L.35 mm.
Art. 13.294 Ø 14,5 mm.
Art. 13.295 Ø 12,5 mm.



H.83 X L.35 mm.
Art. 13.296
Ø foro 12,5 mm.
H.83 X L.35 mm.
Art. 13.296.01
Ø foro 14,5 mm.

Fissaggio con granello
Fastening with dowel



H.90 X L.20 mm.
Art. 13.297
Ø foro 12,5 mm.

Fissaggio con granello
Fastening with dowel



H.42 X L.50 mm.
Art. 13.297.02
Ø foro 30,5 mm.

Fissaggio con granello
Fastening with dowel

*Fissaggio con granello
Fastening with dowel*



H.55 X L.50 mm.
Art. 13.297.03
Ø foro 20,5 mm.
H.55 X L.50 mm.
Art. 13.297.04
Ø foro 25,5 mm.

Fissaggio con granello
Fastening with dowel



H.119 X L.48 mm.
Art. 13.297.05
Ø foro 30,5 mm.

Fissaggio con granello
Fastening with dowel



H.120 X L.65 mm.
Art. 13.297.06
Ø foro 25,5 mm.
H.120 X L.65 mm.
Art. 13.297.07
Ø foro 30,5 mm.

Fissaggio con granello
Fastening with dowel



H.260 X L.50 mm.
Art. 13.297.09
Ø foro 25,5 mm.

Fissaggio con granello
Fastening with dowel



H.55 X L.63 mm.
Art. 13.297.10
Ø foro 25,5 mm.
H.60 X L.73 mm.
Art. 13.297.11
Ø foro 30,5 mm.
H.60 X L.73 mm.
Art. 13.297.12
Ø foro 35,5 mm.

Fissaggio con granello / Fastening with dowel



H.20 X Base 80 X 80 mm.
Art. 13.297.15
□ foro 25,5 mm.



H.13 X Base 24 X 24 mm.
Art. 13.297.17
□ foro 14,5 mm.



H.15 X Base 30 X 30 mm.
Art. 13.297.18
□ foro 20,5 mm.

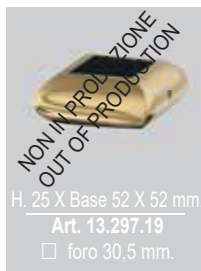

H. 25 X Base 52 X 52 mm.
Art. 13.297.19
□ foro 30,5 mm.



H.50 X L.33 mm.
Art. 13.298 Ø 22 mm
H.50 X L.37 mm.
Art. 13.299 Ø 30 mm

**BORCHIE, LANCE E PIASTRE
STUDS, SPEARS AND PLATES**

H.110 X L.110 mm. - sp. 10 mm.
Art. 13.300 foro 26 mm.
Art. 13.301 foro 31 mm.

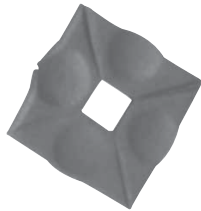

H.70 X L.70 mm. - sp.8 mm.
Art. 13.304 foro 16,5 mm.
Art. 13.305 foro 21 mm.



H.100 X L.100 mm.
Art. 13.308
Spessore 10 mm.



H.100 X L.100 mm.
Art. 13.309
Spessore 10 mm.

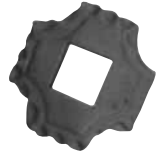

H.70 X L.70 mm. - sp.4 mm.
Art. 13.310 Foro 24 mm.

H.90 X L.90 mm. - sp. 8 mm.
Art. 13.302 foro 21 mm.
Art. 13.303 foro 26 mm.

H.50 X L.50 mm. - sp. 6 mm.
Art. 13.306 foro 12,5 mm.
Art. 13.306.01 foro 14,5 mm.
Art. 13.307 foro 16,5 mm.



H.100 X L.100 mm.
Art. 13.311
Spessore 10 mm.



H.100X L.100 mm. - sp.10 mm.
Art. 13.312 Foro 25 mm.
Art. 13.313 Foro 30 mm.



H.22 mm.
Art. 13.313.01
Base 120 mm.



H.22 X Base 120 mm.
Art. 13.313.02 Ø Foro 50,5 mm.
Art. 13.313.03 Ø Foro 65,5 mm.
Art. 13.313.04 Ø Foro 80,5 mm.

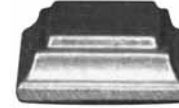

H.20 mm.
Art. 13.314 Base 80 mm.
Art. 13.315 Base 60 mm.
Art. 13.316 Base 50 mm.
Art. 13.317 Base 40 mm.
Art. 13.318 B. 30 X 35 mm.



Base 80 X 80 H.20 mm.
Art. 13.319 Foro 30,5 mm.
Art. 13.320 Foro 35,5 mm.
Art. 13.321 Foro 40,5 mm.
Base 60 X 60 H.20 mm.
Art. 13.322 Foro 25,5 mm.
Art. 13.323 Foro 30,5 mm.

H.20 mm.

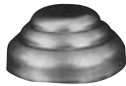

Art. 13.333
Base Ø 80 mm.
Art. 13.334
Base Ø 60 mm.
Art. 13.335
Base Ø 50 mm.
Art. 13.336
Base Ø 40 mm.
Art. 13.337
Base Ø 30 mm.



Base Ø 80 mm.
Art. 13.338 Ø Foro 30,5 mm.
Art. 13.339 Ø Foro 35,5 mm.
Art. 13.340 Ø Foro 40,5 mm.
Base Ø 60 mm.
Art. 13.341 Ø Foro 25,5 mm.
Art. 13.342 Ø Foro 30,5 mm.
Base Ø 50 mm.
Art. 13.343 Ø Foro 16,5 mm.
Art. 13.344 Ø Foro 18,5 mm.
Art. 13.345 Ø Foro 20,5 mm.
Base Ø 40 mm.
Art. 13.346 Ø Foro 12,5 mm.
Art. 13.347 Ø Foro 14,5 mm.
Art. 13.348 Ø Foro 16,5 mm.
Base Ø 30 mm.
Art. 13.349 Ø Foro 12,5 mm.
Art. 13.350 Foro ovale 12,5 mm.



H.1000 16 mm.
Art. 13.350.01
H.1000 20 mm.
Art. 13.350.02



H.250 mm. 14 mm.
Art. 13.350.03
H.250 mm. 16 mm.
Art. 13.350.04



H.250 mm. 16 mm.
Art. 13.350.05
H.250 mm. 20 mm.
Art. 13.350.06

Base 50 X 50 H.20 mm.
Art. 13.324 Foro 16,5 mm.
Art. 13.325 Foro 18,5 mm.
Art. 13.326 Foro 20,5 mm.
Base 40 X 40 H.20 mm.
Art. 13.327 Foro 12,5 mm.
Art. 13.328 Foro 14,5 mm.
Art. 13.329 Foro 16,5 mm.
Base 35 X 30 H.20 mm.
Art. 13.330 Foro 12,5 mm.
Art. 13.331 Foro 14,5 mm.
Art. 13.332 Foro 12X15 mm.

Elementi in Ottone / Brass Studs



H. 110 X L. 55 mm.
Art. 13.351
Base Ø 34 mm.
(filettato MA 8)



H. 63 X L. 42 mm.
Art. 13.353
Base Ø 30 mm.
(filettato MA 8)



H. 70 X L. 40 mm.
Art. 13.356
Base Ø 25 mm.
(filettato MA 8)

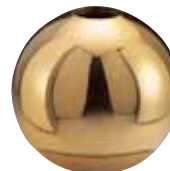

Art. 13.359
Sfera Ø 35 mm.
Foro Ø 14 mm.



Art. 13.362
Sfera Ø 45 mm.
Foro 14 mm.

H. 120 X L. 60 mm.
Art. 13.352
Base Ø 40 mm.
(filettato MA 10)

H. 95 X L. 45 mm.
Art. 13.357
Base Ø 38 mm.
(filettato MA 10)

Art. 13.360
Sfera Ø 45 mm.
Foro Ø 14 mm.

Art. 13.363
Sfera Ø 55 mm.
Foro 14 mm.

H. 110 X L. 55 mm.
Art. 13.358
Base Ø 40 mm.
(filettato MA 10)

Fissaggio con granello
Fastening with dowel
Foro passante
Passing hole

Fissaggio con granello / Fastening with dowel



H.20 X L.40 mm.
Art. 13.364
Foro Ø 16 mm.



H.80 X L.40 mm.
Art. 13.365
Foro Ø 16 mm.



H.120 X L.40 mm.
Art. 13.366
Foro Ø 16 mm.



H.100 X L.30 mm.
Art. 13.367 □14
Art. 13.368 □16

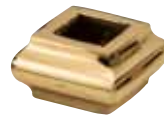

H.20 X L.35 mm.
Art. 13.369 □14



H.35 X L.38 mm.
Art. 13.373 □14
Art. 13.374 □16



H.75 X L.40 mm.
Art. 13.376
Foro Ø 16 mm.



H.30 X L.40 mm.
Art. 13.377
Foro Ø 16 mm.



H.260 X L.50 mm.
Art. 13.378
Foro Ø 20 mm.



H.130 X L.50 mm.
Art. 13.379
Foro Ø 20 mm.



H.190 X L.70 mm.
Art. 13.380
Foro Ø 16 mm.



H.135 X L.40 mm.
Art. 13.381
Foro Ø 16 mm.



H.75 X L.40 mm.
Art. 13.382
Foro Ø 16 mm.



H.30 X L.40 mm.
Art. 13.383
Foro Ø 16 mm.



H.150 X L.50 mm.
Art. 13.384
Foro □16 mm.



H.60 X L.45 mm.
Art. 13.385
Foro □16 mm.



Filettato internamente

H.46 mm. MA 10
Art. 13.386 Ø 45 mm.
H.62 mm. MA 10
Art. 13.388 Ø 65 mm.
H.72 mm. MA 10
Art. 13.389 Ø 75 mm.
H.83 mm. MA 10
Art. 13.390 Ø 85 mm.
H.120 mm. MA 10
Art. 13.392 Ø 120 mm.



H.45 X L.40 mm.
Art. 13.393
Foro Ø 16 mm.



H.45 X L.40 mm.
Art. 13.394
Foro Ø 16 mm.



H.105 X L.40 mm.
Art. 13.400 Foro Ø 12,5mm.
Art. 13.400.01 Foro Ø 14,5mm.
Art. 13.400.02 Foro Ø 16,5mm.



H.75 X L.40 mm.
Art. 13.401 Foro Ø 12,5mm.
Art. 13.401.01 Foro Ø 14,5mm.
Art. 13.401.02 Foro Ø 16,5mm.



H.30 X L.40 mm.
Art. 13.402 Foro Ø 12,5mm.
Art. 13.402.01 Foro Ø 14,5mm.
Art. 13.402.02 Foro Ø 16,5mm.

Distanziali regolabili / Adjustable support

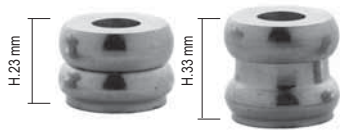

Ferro zincato / Iron
H.23 - 33 mm
Art. 13.510 Ø 30 - foro10,5
H.23 - 33 mm
Art. 13.511 Ø 35 - foro14,5



Ferro zincato / Iron
H.30 - 40 mm
Art. 13.514 Ø 30 - foro14,5
H.30 - 40 mm
Art. 13.515 Ø 35 - foro14,5



Ferro zincato / Iron
H.32 - 42 mm
Art. 13.518 Ø 30 - foro10,5
H.32 - 42 mm
Art. 13.519 Ø 35 - foro14,5



Ferro zincato / Iron
H.45 - 65 mm
Art. 13.522 Ø 30 - foro14,5
H.45 - 65 mm
Art. 13.523 Ø 35 - foro14,5





Spessore 5 mm.
Art. 14.001 Ø 95 mm.



Spessore 4 mm.
Art. 14.002 Ø 95 mm.



Spessore 5 mm.
Art. 14.003 Ø 95 mm.



Spessore 3 mm.
Art. 14.003.01 Ø 68 mm.
Art. 14.003.02 Ø 97 mm.
Art. 14.003.03 Ø 120 mm.



Spessore 4 mm.
Art. 14.004 Ø 62 mm.



Spessore 5 mm.
Art. 14.005 Ø 93 mm.



Spessore 0,8 mm.
Art. 14.005.01 Ø 77 mm.
Art. 14.005.02 Ø 111 mm.



H.10 - Spessore 0,8 mm.
Art. 14.005.03 Ø 85 mm.
Foro Ø 10 mm.



H.35 - Spessore 2 mm.
Art. 14.005.04 Ø 135 mm.
Foro Ø 11 mm.



H.17 - Spessore 0,5 mm.
Art. 14.005.05 Ø 80 mm.
Foro Ø 10 mm.



Spessore 3 mm.
Art. 14.005.06 Ø 60 mm.
Foro Ø 10 mm.

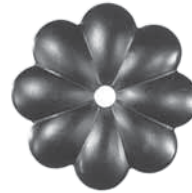

Spessore 3 mm.
Art. 14.005.07 Ø 90 mm.
Foro Ø 10 mm.



H.21 - Spessore 1 mm.
Art. 14.005.08 Ø 105 mm.
Foro Ø 10 mm.



H.10 - Spessore 10 mm.
Art. 14.006 Ø 65 mm.
Foro Ø 12,5 mm.

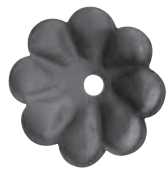

Spessore 3 mm.
Art. 14.007 Ø 60 mm.



Spessore 3 mm.
Art. 14.008 Ø 92 mm.



Spessore 3 mm.
Art. 14.010 Ø 118 mm.

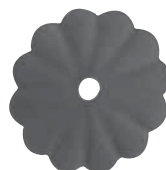

Spessore 3 mm.
Art. 14.011 Ø 98 mm.



Spessore 3 mm.
Art. 14.012 Ø 122 mm.

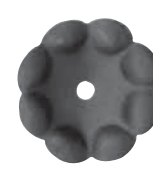

Spessore 3 mm.
Art. 14.013 Ø 60 mm.



Spessore 3 mm.
Art. 14.014 Ø 90 mm.



Spessore 3 mm.
Art. 14.015 Ø 60 mm.



Spessore 3 mm.
Art. 14.015.01 Ø 62 mm.



Spessore 3 mm.
Art. 14.016 Ø 95 mm.
Art. 14.015.01 Ø 120 mm.



Spessore 2 mm.
Art. 14.017 Ø 60 mm.



Spessore 2 mm.
Art. 14.018 Ø 60 mm.



Spessore 1 mm.
Art. 14.018.01 Ø 37 mm.



Spessore 5 mm.
Art. 14.018.02 Ø 60 mm.
Foro Ø 10 mm.



Spessore 3 mm.
Art. 14.019 Ø 40 mm.



Spessore 2 mm.
Art. 14.019.01 Ø 60 mm.



Spessore 3 mm.
Art. 14.020 Ø 65 mm.



Spessore ≠ 3 mm
Art. 14.021 Ø 60 mm.



Spessore 7 mm.
Art. 14.022 Ø 68 mm.



Spessore 2 mm.
Art. 14.023 Ø 90 mm.



Spessore 2 mm.
Art. 14.024 Ø 135 mm.
Foro Ø 10 mm.



Spessore 2 mm.
Art. 14.025 Ø 85 mm.



Spessore 2 mm.
Art. 14.026 Ø 85 mm.



H.40 - Spessore 0,5 mm.
Art. 14.027 Ø 40 mm.

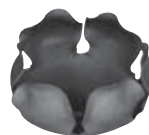

H.35 - Spessore 0,5 mm.
Art. 14.028 Ø 55 mm.



H.30 - Spessore 0,5 mm.
Art. 14.029 Ø 65 mm.

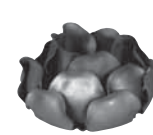

Esempio unito non saldato
United example not welded



H.50 mm - Spessore 2 mm.
Art. 14.026.01 Ø 75 mm.
Foro Ø 10 mm.



H.70 mm - Spessore 0,6 mm.
Art. 14.027 Ø 90 mm.



Spessore 3 mm.
Art. 14.027.01 Ø 60 mm.



Spessore 3 mm.
Art. 14.027.02 Ø 60 mm.



Spessore 2 mm.
Art. 14.027.03 Ø 68 mm.
Foro Ø 8 mm.



Spessore 2 mm.
Art. 14.027.04 Ø 95 mm.
Foro Ø 8 mm.



H. 42 - Spessore 0,6 mm.
Art. 14.030 Ø 40 mm.



Spessore 3 mm.
Art. 14.032.01 Ø 130 mm.



Spessore 0,6 mm.
Art. 14.034 Ø 65 mm.



Spessore 1 mm.
Art. 14.034.01 Ø 70 mm.

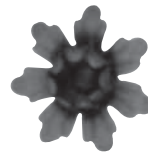

Spessore 0,5 mm.
Art. 14.035 Ø 42 mm.



Spessore 3 mm.
Art. 14.035.01 Ø 110 mm.



H 45 mm-Spessore 1,5 mm.
Art. 14.035.02 Ø 35 mm.



H 47 mm-Spessore 1,5 mm.
Art. 14.035.03 Ø 60 mm.



H 135 X L.80 mm
Art. 14.035.04



H 325 mm
Art. 14.035.05 Ø 6 mm.



H 325 mm
Art. 14.035.06 Ø 6 mm.



H 325 mm
Art. 14.035.07 Ø 6 mm.



H 325 mm
Art. 14.035.08 Ø 6 mm.



H 180 mm
Art. 14.035.09 Ø 3 mm.

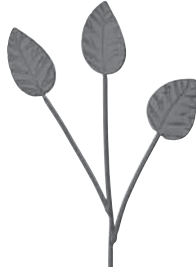

H 180 X L.130 mm
Art. 14.035.10 Ø 3 mm.

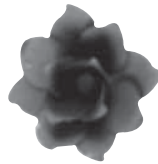

Spessore 0,5 mm.
Art. 14.036 Ø 48 mm.



Spessore 1 mm.
Art. 14.036.01 Ø 70 mm.



H. 45 X L.25 mm.
Art. 14.036.02
Spessore 0,5 mm.



H. 45 X L.30 mm.
Art. 14.036.03
Spessore 1,5 mm.



H. 70 X L.30 mm.
Art. 14.036.04
Spessore 0,5 mm.



H. 65 X L.55 mm.
Art. 14.036.05
Spessore 0,5 mm.



H. 115 X L.65 mm.
Art. 14.036.06
Spessore 0,5 mm.



H. 60 X L.50 mm.
Art. 14.036.07
Spessore 0,5 mm.



H. 55 X L.70 mm.
Art. 14.036.08
Spessore 1 mm.



H. 85 X L.45 mm.
Art. 14.037
Spessore 0,5 mm.



H. 83 X L.44 mm.
Art. 14.037.01
Spessore 1 mm.



H. 55 X L.31 mm.
Art. 14.037.02
Spessore 1 mm.



H. 70 X L.35 mm.
Art. 14.038
Spessore 0,5 mm.



H. 82 X L.47 mm.
Art. 14.038.01
Spessore 1 mm.



H. 195 X L.80 mm.
Art. 14.039
Spessore 0,5 mm.



H. 70 X L.78 mm.
Art. 14.039.01
Spessore 3 mm



H. 108 X L.120 mm.
Art. 14.039.02
Spessore 3 mm



H. 145 X L.160 mm.
Art. 14.039.03
Spessore 3 mm.



H. 57 X L.55 mm.
Art. 14.040
Spessore 0,6 mm.



H. 75 X L.70 mm.
Art. 14.041
Spessore 0,6 mm.



H. 105 X L.95 mm.
Art. 14.042
Spessore 1 mm.



H. 200 X L.190 mm.
Art. 14.043
Spessore 1 mm.



H. 130 X L.65 mm.
Art. 14.044
Spessore 1 mm.



H. 90 X L.45 mm.
Art. 14.045
Spessore 1 mm.



H. 240 X L.70 mm.
Art. 14.046
Spessore 0,5 mm.



H.175 mm.
Art. 14.046.01
Base 22 X 19 mm.



H. 170 X L.40 mm.
Art. 14.047
Spessore 0,5 mm.



H. 120 X L.40 mm.
Art. 14.048
Spessore 0,5 mm.



H. 294 X L.48 mm.
Art. 14.048.01
Spessore 1 mm.



H. 294 X L.48 mm.
Art. 14.048.02
Spessore 1 mm.



H. 163 X L.30 mm.
Art. 14.048.03
Spessore 1 mm.



H. 60 X L.110 mm.
Art. 14.049
Spessore 1 mm.



H. 125 X L.175 mm.
Art. 14.050
Spessore 1 mm.



H.158 X L.80 mm.
Art. 14.050.01
Spessore 1 mm.



H.155X L.80 mm.
Art. 14.050.02
Spessore 1 mm.



H.27 - Spessore 1 mm.
Art. 14.050.03 Ø 150 mm.
Foro Ø 10,5 mm.



H.45 - Spessore 1 mm.
Art. 14.050.04 Ø 120 mm.
Foro Ø 12,5 mm.



H.200 X L.95 mm.
Art. 14.050.05
Spessore 1 mm.



H.230 X L.100 mm.
Art. 14.050.06
Spessore 1 mm.

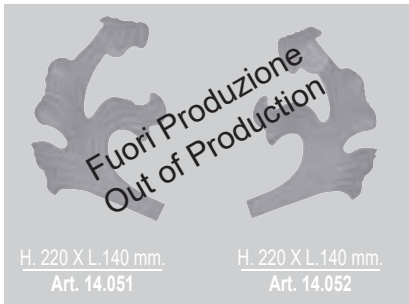

H. 220 X L.140 mm.
Art. 14.051

H. 220 X L.140 mm.
Art. 14.052



H. 190 X L.140 mm.
Art. 14.053



H. 190 X L.140 mm.
Art. 14.054



H. 180 X L.130 mm.
Art. 14.055



H. 180 X L.130 mm.
Art. 14.056



H. 170 X L.140 mm.
Art. 14.057



H. 170 X L.140 mm.
Art. 14.058



H. 155 X L.60 mm.
Art. 14.059
H. 180 X L.65 mm.
Art. 14.059.01



H. 155 X L.60 mm.
Art. 14.060
H. 180 X L.65 mm.
Art. 14.060.01



H. 110 X L.40 mm.
Art. 14.061



H. 110 X L.40 mm.
Art. 14.062



H. 90 X L.30 mm.
Art. 14.063



H. 90 X L.30 mm.
Art. 14.064



H. 125 X L.75 mm.
Art. 14.065



H. 125 X L.75 mm.
Art. 14.066



H. 110 X L.105 mm.
Art. 14.067



H. 110 X L.105 mm.
Art. 14.068



H. 80 X L.60 mm.
Art. 14.069



H. 80 X L.60 mm.
Art. 14.070



H. 75 X L.80 mm.
Art. 14.071



H. 75 X L.80 mm.
Art. 14.072



H. 55 X L.70 mm.
Art. 14.073



H. 55 X L.70 mm.
Art. 14.074



H. 80 X L.55 mm.
Art. 14.074.01
≙ 16 X 3 mm.



H. 80 X L.55 mm.
Art. 14.074.02
≙ 16 X 3 mm.



H. 64 X L.69 mm.
Art. 14.074.03
≙ 14 X 3 mm.



H. 64 X L.69 mm.
Art. 14.074.04
≙ 14 X 3 mm.



H. 300 X L.70 mm.
Art. 14.078.01
Spessore 4 mm.



H. 185 X L.90 mm.
Art. 14.078.02
Spessore 10 mm.



H. 90 X L.75 mm.
Art. 14.075



H. 90 X L.75 mm.
Art. 14.076



H. 110 X L.75 mm.
Art. 14.077



H. 110 X L.75 mm.
Art. 14.078



H. 210 X L.45 mm.
Art. 14.078.04
Spessore 4 mm.



H. 215 X L.110 mm.
Art. 14.079
Spessore 3 mm.



H. 205 X L.100 mm.
Art. 14.080
Spessore 3 mm.



H. 165 X L.70 mm.
Art. 14.081
Spessore 3 mm.



H. 125 X L.82 mm.
Art. 14.082
Spessore 3 mm.



H. 140 X L.85 mm.
Art. 14.083
Spessore 3 mm.



Base Ø 76 mm.
Art. 14.083.01
Spessore 20 mm.



Base Ø 90 mm.
Art. 14.083.02
Spessore 8 mm.
Base Ø 55 mm.
Art. 14.083.03
Spessore 8 mm.



H. 18 X L.35 mm.
Art. 14.083.04



Base Ø 125 mm.
Art. 14.083.05
Spessore 15 mm.
Base Ø 90 mm.
Art. 14.083.06
Spessore 12 mm.
Base Ø 55 mm.
Art. 14.083.07
Spessore 8 mm.



H. 185 X L.100 mm.
Art. 14.084
Spessore 10 mm.



H. 80 X L.70 mm.
Art. 14.084.01
Spessore 3 mm.



Base Ø 100 mm..
Art. 14.084.02
Spessore 3 mm.



H. 135 X L.85 mm.
Art. 14.084.03 / Dx
Art. 14.084.05 / Sx
Spessore 3 mm.



H. 130 X L.75 mm.
Art. 14.087
Spessore 5 mm.



Foglie Forgiate
Forged Leaves

H. 260 X L.45 mm.
Art. 14.087.01
Spessore 5 mm. circa



Foglie Forgiate
Forged Leaves

H. 400 X L.60 mm.
Art. 14.087.02
Spessore 8 mm. circa



Foglie Forgiate
Forged Leaves

H. 420 X L.90 mm.
Art. 14.087.03
Spessore 8 mm. circa



Foglie Forgiate
Forged Leaves

H.270 X L.60 mm.
Art. 14.087.04
Spessore 8 mm. circa



H. 115 X L.100 mm.
Art. 14.084.04 / Dx
Art. 14.084.06 / Sx
Spessore 3 mm.



H. 97 X L.55 mm.
Art. 14.087.05
Spessore 4 mm



H. 90 X L.55 mm.
Art. 14.087.06
Spessore 4 mm



H. 240 X L.77 mm.
Art. 14.087.07
Spessore 4 mm



H.225 X L.60 mm.
Art. 14.087.08
Spessore 4 mm.



H.190 X L.45 mm.
Art. 14.087.09
Spessore 4 mm.

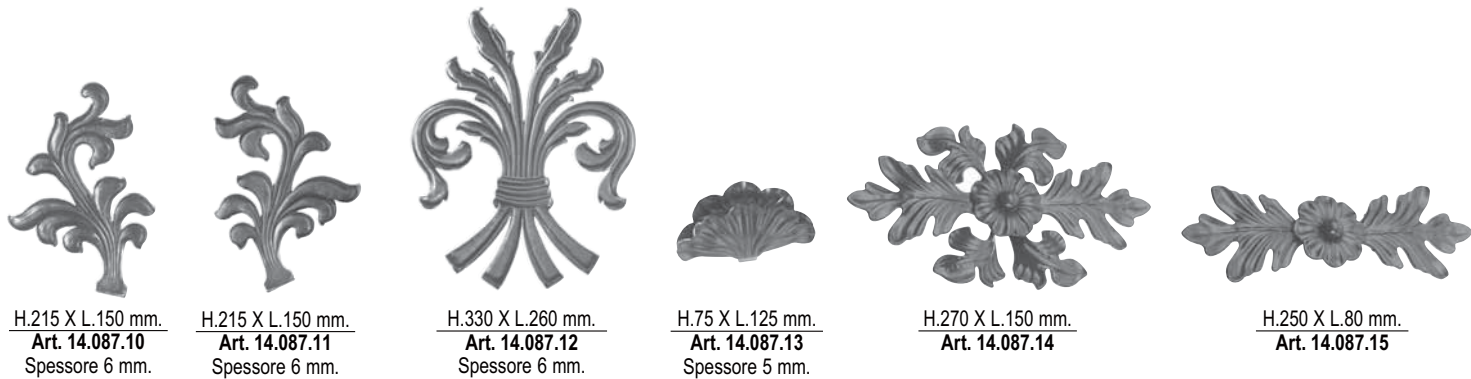

H.215 X L.150 mm.
Art. 14.087.10
Spessore 6 mm.

H.215 X L.150 mm.
Art. 14.087.11
Spessore 6 mm.

H.330 X L.260 mm.
Art. 14.087.12
Spessore 6 mm.

H.75 X L.125 mm.
Art. 14.087.13
Spessore 5 mm.

H.270 X L.150 mm.
Art. 14.087.14

H.250 X L.80 mm.
Art. 14.087.15

Decorazioni in Acciaio e Ottone / Brass and Steel Decorations

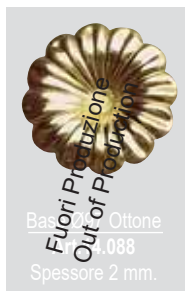

Base Ø 97 mm.
Art. 14.088
Spessore 2 mm.



Base Ø 97 Acciaio
Art. 14.089
Spessore 1,5 mm.



H.80 X L.70 mm.
Art. 14.090
Ottone-Spessore 2 mm.



H.80 X L.70 mm.
Art. 14.091
Acciaio-Spessore 1,5 mm.



H.115 X L.100 mm.
Art. 14.092 Ottone-Sp. 2 mm./dx
Art. 14.092.01 Ottone-Sp. 2 mm./sx
Art. 14.093 Acciaio-Sp. 1,5 mm./dx
Art. 14.093.01 Acciaio-Sp. 1,5 mm./sx



H.135 X L.85 mm.
Art. 14.094 Ottone-Sp. 2 mm./dx
Art. 14.094.01 Ottone-Sp. 2 mm./sx
Art. 14.095 Acciaio-Sp. 1,5 mm./dx
Art. 14.095.01 Acciaio-Sp. 1,5 mm./sx



Base Ø 100 mm.
Art. 14.097 Acciaio-Sp. 1,5 mm.



H.90 X L.30 mm.
Art. 14.098 Ottone-Sp. 2 mm./dx
Art. 14.098.01 Ottone-Sp. 2 mm./sx
Art. 14.099 Acciaio-Sp. 1,5 mm./dx
Art. 14.099.01 Acciaio-Sp. 1,5 mm./sx



H.115X L.50 mm.
Art. 14.100 Ottone-Sp. 2 mm./dx
Art. 14.100.01 Ottone-Sp. 2 mm./sx
Art. 14.101 Acciaio-Sp. 1,5 mm./dx
Art. 14.101.01 Acciaio-Sp. 1,5 mm./sx



H.75X L.65 mm.
Art. 14.102 Ottone-Sp. 2 mm./dx
Art. 14.102.01 Ottone-Sp. 2 mm./sx
Art. 14.103 Acciaio-Sp. 1,5 mm./dx
Art. 14.103.01 Acciaio-Sp. 1,5 mm./sx



Filettato / Threaded MA 5.
H. 95 X L.95 mm.
Art. 14.106



Filettato / Threaded MA 4
H.10 X Ø 40 mm.
Art. 14.107



Filettato / Threaded MA 4
H.7 X Ø 38 mm.
Art. 14.108



Filettato / Threaded MA 4
H.7 X Ø 66 mm.
Art. 14.109



H.18 - Spessore 4 mm.
Art. 14.109.01 Ø 60 mm.
Foro/Hole Ø 6 mm.



Filettato / Threaded MA 6
Spessore 8 mm.
Art. 14.109.02 Ø 55 mm.



Filettato / Threaded MA 6
Spessore 13 mm.
Art. 14.109.03 Ø 78 mm.



Tutte le parti di questo catalogo - foto comprese - sono di proprietà Euro-Fer. La riproduzione, anche parziale, è vietata in ogni forma e con ogni mezzo. / Every part of this catalogue - photos included - is Euro-Fer's property. All forms of copying are strictly prohibited.

Decorazioni in Acciaio e Ottone / *Brass and Steel Decorations*



Filettato / *Threaded MA 6*
H.85 X L.55mm.
Art. 14.109.04
Spessore/Thickness 4 mm.



Spessore 2 mm.
Art. 14.110 Ø 20 mm.
Art. 14.111 Ø 25 mm.
Art. 14.112 Ø 30 mm.
Art. 14.113 Ø 35 mm.
Art. 14.114 Ø 40 mm.
Art. 14.115 Ø 50 mm.
Art. 14.116 Ø 60 mm.



Filettato / *Threaded MA 8*
H.115 X L.58 mm.
Art. 14.118 Ø 20 mm
H.140 X L.70 mm. MA8
Art. 14.119 Ø 26 mm



Filettato / *Threaded MA 8*
H.150 X L.60 mm.
Art. 14.120 Ø 25 mm



H.200 X L.70 mm.
Art. 14.151



H.200 X L.60 mm.
Art. 14.152



H.180 X L.60 mm.
Art. 14.153



H. 250 X L.48 mm
Art. 14.160
Ø 6 mm



Tutte le parti di questo catalogo - foto comprese - sono di proprietà Euro-Fer. La riproduzione, anche parziale, è vietata in ogni forma e con ogni mezzo. / Every part of this catalogue - photos included - is Euro-Fer's property. All forms of copying are strictly prohibited.



Sinistro / *Left*
H. 180 X L. 150 mm.
Art. 14.200
Spessore 4 mm.



Destro / *Right*
H. 180 X L. 150 mm.
Art. 14.201
Spessore 4 mm.



Sinistro / *Left*
H. 130 X L. 55 mm.
Art. 14.202
Spessore 4 mm.



Destro / *Right*
H. 130 X L. 55 mm.
Art. 14.203
Spessore 4 mm.



Sinistro / *Left*
H. 200 X L. 150 mm.
Art. 14.204
Spessore 5 mm.
Base Ø 12



Destro / *Right*
H. 200 X L. 150 mm.
Art. 14.205
Spessore 5 mm
Base Ø 12.



Sinistro / *Left*
H. 115 X L. 170 mm
Art. 14.206
Ø 12 mm



Destro / *Right*
H. 115 X L. 170 mm
Art. 14.207
Ø 12 mm



Sinistro / *Left*
H. 190 X L. 180 mm
Art. 14.208



Destro / *Right*
H. 190 X L. 180 mm
Art. 14.209



Sinistro / *Left*
H. 130 X L. 150 mm
Art. 14.210



Destro / *Right*
H. 130 X L. 150 mm
Art. 14.211



Sinistro / *Left*
H. 175 X L. 130 mm
Art. 14.212
Ø 12 mm



Destro / *Right*
H. 175 X L. 130 mm
Art. 14.213
Ø 12 mm



Sinistro / *Left*
H. 235 X L. 130 mm
Art. 14.214



Destro / *Right*
H. 235 X L. 130 mm
Art. 14.215



Sinistro / *Left*
H. 90 X L. 95 mm
Art. 14.216
Ø 12 mm



Destro / *Right*
H. 90 X L. 95 mm
Art. 14.217
Ø 12 mm



Sinistro / *Left*
H. 135 X L. 105 mm
Art. 14.218



Destro / *Right*
H. 135 X L. 105 mm
Art. 14.219

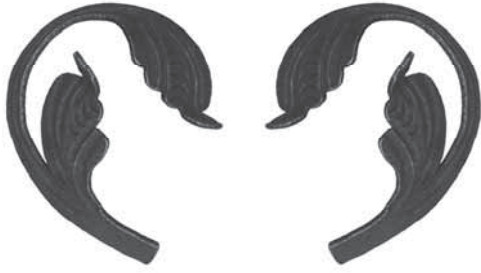

Sinistro / Left
H. 160 X L. 125 mm
Art. 14.220



Destro / Right
H. 160 X L. 125 mm
Art. 14.221



Sinistro / Left
H. 110 X L. 95 mm
Art. 14.222



Destro / Right
H. 110 X L. 95 mm
Art. 14.223



Sinistro / Left
H. 100 X L. 80 mm
Art. 14.224



Destro / Right
H. 100 X L. 80 mm
Art. 14.225



Sinistro / Left
H. 80 X L. 60 mm
Art. 14.226



Destro / Right
H. 80 X L. 60 mm
Art. 14.227

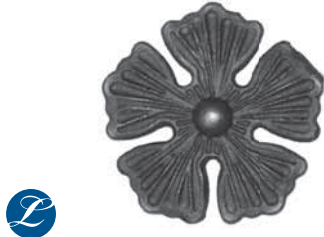

Base 110 mm
Art. 14.250
Spessore 14 mm



Base 89 mm
Art. 14.251
Spessore 25 mm



Base 97 mm
Art. 14.252
Spessore 14 mm



H. 140 X L. 115 mm
Art. 14.253
Ø 12 mm



Base 50 mm
Art. 14.254
Spessore 3 mm



H. 275 X L. 88 mm
Art. 14.270
Spessore 3 mm



H. 242 X L. 70 mm
Art. 14.271
Spessore 3 mm



H. 175 X L.60 mm.
Art. 15.001
Spessore 10 mm.



H. 135 X L.45 mm.
Art. 15.002
Spessore 10 mm.



H. 165 X L.55 mm.
Art. 15.003
Spessore 10 mm.



Martellato / *Hammered*
Art. 15.003.01
≠ 30 X 8 mm.



Martellato / *Hammered*
Art. 15.003.02
≠ 40 X 8 mm.



Martellato / *Hammered*
H. 300 X L.40 mm.
Art. 15.003.03
≠ 25 X 8 mm.



Martellato / *Hammered*
H. 300 X L.45 mm.
Art. 15.003.04
≠ 30 X 8 mm.



Martellato / *Hammered*
H. 300 X L.55 mm.
Art. 15.003.05
≠ 40 X 8 mm.



H. 180 X L.85 mm.
Art. 15.003.06 Ø 12 mm.



H. 180 X L.85 mm.
Art. 15.003.07 □ 10 mm.



H. 110 mm.
Art. 15.003.08 Ø 10 mm.



H. 180 X L.95 mm.
Art. 15.004 □ 14 X 14 mm.



H. 120 X L.130 mm.
Art. 15.005 □ 14 X 14 mm.



H. 240 X L.140 mm.
Art. 15.006 □ 12 X 12 mm.



H. 500 mm.
Art. 15.006.01 ≠ 80 X 8 mm.
Art. 15.006.02 ≠ 100 X 8 mm.
Art. 15.006.03 ≠ 120 X 8 mm.



H. 500 mm.
Art. 15.006.07 ≠ 80 X 8 mm.
Art. 15.006.08 ≠ 100 X 8 mm.
Art. 15.006.09 ≠ 120 X 8 mm.

H. 800 mm.
Art. 15.006.04 ≠ 80 X 8 mm.
Art. 15.006.05 ≠ 100 X 8 mm.
Art. 15.006.06 ≠ 120 X 8 mm.

H. 800 mm.
Art. 15.006.10 ≠ 80 X 8 mm.
Art. 15.006.11 ≠ 100 X 8 mm.
Art. 15.006.12 ≠ 120 X 8 mm.



Martellato / *Hammered*
H. 300 mm.
Art. 15.006.13 □ 12 mm.



H. 410 X L.195 mm.
Art. 15.007
□ 20 mm. ≠ 20 x 12

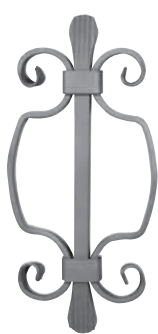

H. 410 X L.195 mm.
Art. 15.008
□ 20 mm. ≠ 20 x 8



H. 410 X L.165 mm.
Art. 15.009
□ 20 mm. ≠ 20 x 10



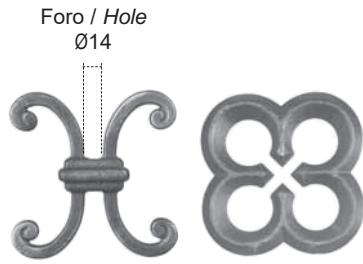

Foro / Hole
Ø14

H. 130 X L.130 mm.
Art. 15.009.01
Spessore 12 mm.

Ø 112 mm.
Art. 15.009.02
Spessore 14 mm.



H. 300 mm.
Art. 15.010 □ 25 mm.
Art. 15.011 □ 30 mm.
Art. 15.012 □ 35 mm.
Art. 15.013 □ 40 mm.

H. 350 mm.
Art. 15.013.01 □ 25 mm.
Art. 15.013.02 □ 30 mm.
Art. 15.013.03 □ 35 mm.
Art. 15.013.04 □ 40 mm.

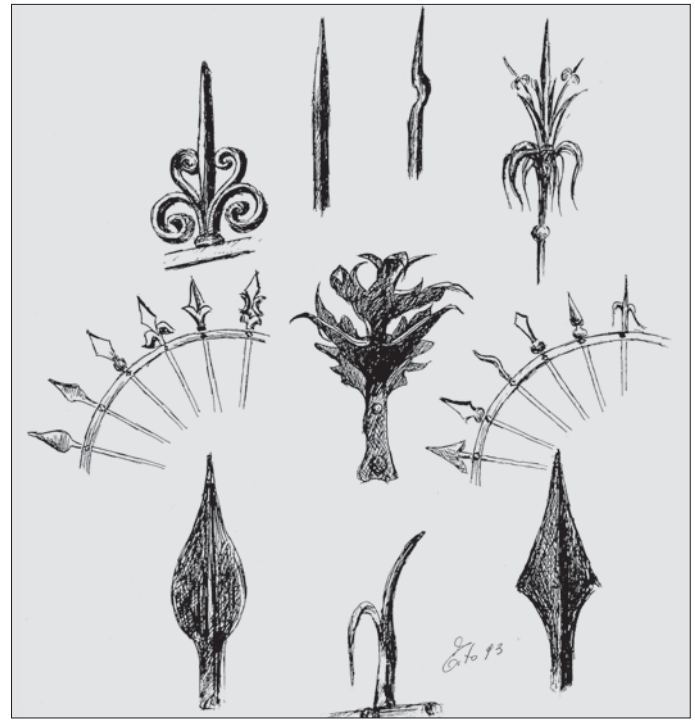

Martellato / Hammered
H. 350 mm.

Art. 15.013.05 □ 25 mm.
Art. 15.013.06 □ 30 mm.
Art. 15.013.07 □ 35 mm.
Art. 15.013.08 □ 40 mm.



Tondo / Round
H. 350 mm.

Art. 15.013.09 Ø 25 mm.
Art. 15.013.10 Ø 30 mm.
Art. 15.013.11 Ø 35 mm.
Art. 15.013.12 Ø 40 mm.



H. 350 mm.

Art. 15.013.13 □ 25 mm.
Art. 15.013.14 □ 30 mm.
Art. 15.013.15 □ 35 mm.
Art. 15.013.51 □ 40 mm.



Martellato / Hammered
H. 350 mm.

Art. 15.013.16 □ 25 mm.
Art. 15.013.17 □ 30 mm.
Art. 15.013.18 □ 35 mm.
Art. 15.013.52 □ 40 mm.



Tondo / Round
H. 350 mm.

Art. 15.013.19 Ø 25 mm.
Art. 15.013.20 Ø 30 mm.



H. 350 mm.

Art. 15.013.21 □ 25 mm.
Art. 15.013.22 □ 30 mm.



Martellato / Hammered
H. 350 mm.

Art. 15.013.23 □ 25 mm.
Art. 15.013.24 □ 30 mm.



Tondo / Round
H. 350 mm.

Art. 15.013.25 Ø 25 mm.
Art. 15.013.26 Ø 30 mm.



H. 350 mm.

Art. 15.013.27 □ 25 mm.
Art. 15.013.28 □ 30 mm.
Art. 15.013.29 □ 35 mm.
Art. 15.013.30 □ 40 mm.



Martellato / Hammered
H. 350 mm.

Art. 15.013.31 □ 25 mm.
Art. 15.013.32 □ 30 mm.
Art. 15.013.33 □ 35 mm.
Art. 15.013.34 □ 40 mm.



H. 350 mm.

Art. 15.013.35 □ 25 mm.
Art. 15.013.36 □ 30 mm.
Art. 15.013.37 □ 35 mm.
Art. 15.013.38 □ 40 mm.



Martellato / Hammered
H. 350 mm.

Art. 15.013.39 □ 25 mm.
Art. 15.013.40 □ 30 mm.
Art. 15.013.41 □ 35 mm.
Art. 15.013.42 □ 40 mm.



H. 360 mm.

Art. 15.013.45 □ 25 mm.
Art. 15.013.46 □ 30 mm.
Art. 15.013.47 □ 35 mm.



Martellato / Hammered
H. 360 mm.

Art. 15.013.48 □ 25 mm.
Art. 15.013.49 □ 30 mm.
Art. 15.013.50 □ 35 mm.



Martellato / Hammered
H. 350 mm
Art. 15.013.60 □ 25 mm
Art. 15.013.61 □ 30 mm

Liscio / Smooth
H. 350 mm
Art. 15.013.62 □ 25 mm
Art. 15.013.63 □ 30 mm
Art. 15.013.64 Ø 25 mm
Art. 15.013.65 Ø 30 mm

Martellato / Hammered
H. 300 mm.
Art. 15.014 □ 25 mm.
Art. 15.015 □ 30 mm.

Mod. Scala / Scala Model
H. 350 mm.
Art. 15.015.01 □ 25 mm.
Art. 15.015.02 □ 30 mm.

H. 350 mm.
Art. 15.015.03 □ 25 mm.
Art. 15.015.04 □ 30 mm.

Martellato / Hammered
H. 350 mm.
Art. 15.015.05 □ 25 mm.
Art. 15.015.06 □ 30 mm.

Tondo / Round
H. 350 mm.
Art. 15.015.07 Ø 25 mm.
Art. 15.015.08 Ø 30 mm.



Tondo Lavorato
Worked Round Bar
H. 350 mm.
Art. 15.015.09 Ø 25 mm.
Art. 15.015.10 Ø 30 mm.

Martellato / Hammered
H. 300 mm.
Art. 15.016 □ 25 mm.
Art. 15.017 □ 30 mm.
Art. 15.017.01 □ 35 mm.
Art. 15.017.02 □ 40 mm.
Art. 15.017.03 □ 25 mm. Liscio/Smooth
Art. 15.017.04 □ 30 mm. Liscio/Smooth
Art. 15.017.05 □ 35 mm. Liscio/Smooth
Art. 15.017.06 □ 40 mm. Liscio/Smooth

Mod. Scala / Scala Model
H. 350 mm.
Art. 15.017.07 □ 25 mm.
Art. 15.017.08 □ 30 mm.
Art. 15.017.09 □ 35 mm.

H. 350 mm.
Art. 15.017.10
≠ 30 x 20

Martellato / Hammered
H. 350 mm.
Art. 15.017.11
≠ 30 x 20

Martellato / Hammered
H. 350 mm.
Art. 15.017.12 □ 25 mm.
Liscio / Smooth
H. 350 mm.
Art. 15.017.13 □ 25 mm.

Tutte le parti di questo catalogo - foto comprese - sono di proprietà Euro-Fer. La riproduzione, anche parziale, è vietata in ogni forma e con ogni mezzo. / Every part of this catalogue - photos included - is Euro-Fer's property. All forms of copying are strictly prohibited.

**CIMASE, TERMINALI ED ELEMENTI VARI
ORNAMENTS FOR CARRIAGE GATES AND VARIOUS ELEMENTS**



H. 300 mm.
Art. 15.018
≠ 70 X 6 mm.
Art. 15.018.50
≠ 50 X 6 mm.
Art. 15.018.51
≠ 60 X 6 mm.
Art. 15.018.52
≠ 80 X 6 mm.



Mod. Scala / *Scala Model*
H. 350 mm.
Art. 15.018.01
≠ 60 X 8 mm.



H. 350 mm.
Art. 15.018.02
≠ 40 X 6 mm.
Art. 15.018.03
≠ 50 X 6 mm.



H. 300 mm.
Art. 15.018.04
≠ 40 X 6 mm.
Art. 15.018.05
≠ 50 X 6 mm.
Art. 15.018.06
≠ 60 X 6 mm.



H. 350 mm.
Art. 15.018.07
≠ 50 X 8 mm.



Martellato / *Hammered*
H. 350 mm.
Art. 15.018.08
≠ 50 X 8 mm.



H. 350 mm.
Art. 15.018.09
≠ 50 X 10 mm.



Mod. Scala / *Scala Model*
H. 350 mm.
Art. 15.018.10
≠ 60 X 8 mm.

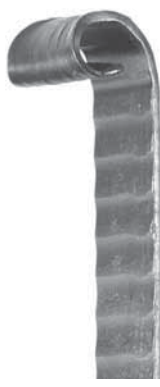

Battuto / *Beaten*
H. 350 mm.
Art. 15.018.11
≠ 60 X 8 mm.



H. 300 mm.
Art. 15.019
≠ 70 X 6 mm.

**Ribattini Martellati
Hammered-Head Rivets**



H. 30 mm. - Ø 10 mm.
Art. 15.019.01
Testa / Head Ø 20



H. 30 mm. - Ø 10 mm.
Art. 15.019.02
Testa / Head Ø 24

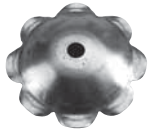

H. 11 mm. - Ø 46 mm.
Art. 15.019.03

**Chiodi di Ferro
Iron Nails**



Art. 15.019.23 H. 230 □ 10 mm.
Art. 15.019.27 H. 270 □ 10 mm.
Art. 15.019.30 H. 300 □ 10 mm.

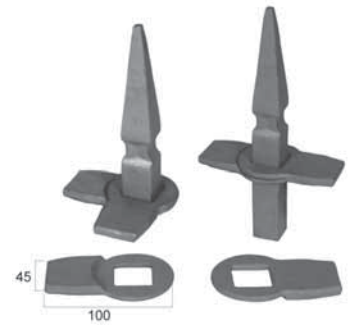

Spessore 10 mm.
Art. 15.021
□ Foro 32 mm.



H. 60 X L. 100 mm.
Art. 15.021.03
Spessore 35 mm.



H. 60 X L. 60 mm.
Art. 15.021.04
Spessore 40 mm.



H. 35 mm. - Ø 100 mm
Art. 15.021.08
Spessore 12 mm.



L. 105 mm
≠ 40 x 8 mm
Art. 15.021.50
foro/hole ø 35 x 17 mm



Art. 15.022 L. 6 X H. 20 mm.
Art. 15.023 L. 6 X H. 25 mm.
Art. 15.024 L. 6 X H. 30 mm.
Art. 15.025 L. 6 X H. 35 mm.
Art. 15.026 L. 6 X H. 40 mm.
Art. 15.027 L. 6 X H. 45 mm.
Art. 15.028 L. 6 X H. 50 mm.

Art. 15.029 L. 8 X H. 20 mm.
Art. 15.030 L. 8 X H. 25 mm.
Art. 15.031 L. 8 X H. 30 mm.
Art. 15.032 L. 8 X H. 35 mm.
Art. 15.033 L. 8 X H. 40 mm.
Art. 15.034 L. 8 X H. 45 mm.
Art. 15.035 L. 8 X H. 50 mm.
Art. 15.036 L. 10 X H. 25 mm.
Art. 15.037 L. 10 X H. 30 mm.
Art. 15.038 L. 10 X H. 35 mm.
Art. 15.039 L. 10 X H. 40 mm.
Art. 15.040 L. 10 X H. 45 mm.
Art. 15.041 L. 10 X H. 50 mm.

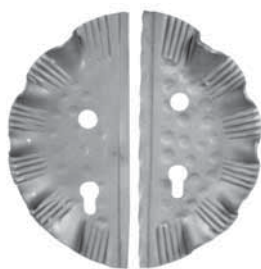
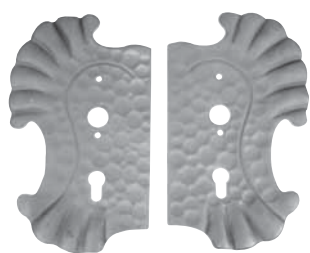

H. 275 X L.160 mm.

H. 275 X L.160 mm.

H. 260 X L.115 mm.

H. 260 X L.115 mm.

H. 295 X L.130 mm.

H. 295 X L.130 mm.

H. 230 X L.80 mm.

H. 300 X L.105 mm.

Art. 15.042

Art. 15.043

Art. 15.044

Art. 15.045

Art. 15.046

Art. 15.047

Art. 15.048

Art. 15.049

Spessore 3 mm.

Spessore 3 mm.

Spessore 3 mm.

Spessore 3 mm.

Spessore 3 mm.

Spessore 3 mm.

Spessore 6 mm.

Spessore 6 mm.

Art. 15.042.01
Senza Foro
Without Hole

Art. 15.043.01
Senza Foro
Without Hole

Art. 15.044.01
Senza Foro
Without Hole

Art. 15.045.01
Senza Foro
Without Hole

Art. 15.046.01
Senza Foro
Without Hole

Art. 15.047.01
Senza Foro
Without Hole

SUPPORTI PER MENSOLE
SUPPORTS FOR SHELVES
colore nero / black colour



H.200 x L.90 mm

H. 200 X L.160 mm.

H. 155 X L.125 mm.

H. 225 X L.175 mm.

H. 280 X L.220 mm.

Art. 15.049.10
≠ 3 mm

Art. 15.050
≠ 20 X 4

Art. 15.050.01

Art. 15.050.02

Art. 15.050.03

Copricolonna
Post Caps



H. 22 mm.

Art. 15.051

□ 60 X 60

Copricolonna
Post Caps



Art. 15.052 □ 30 X 30
Art. 15.053 □ 40 X 40
Art. 15.054 □ 50 X 50
Art. 15.055 □ 60 X 60
Art. 15.056 □ 80 X 80
Art. 15.057 □ 100 X 100
Art. 15.058 □ 120 X 120
Art. 15.059 □ 150 X 150

Copricolonna saldati e molati
Post caps welded and grinded

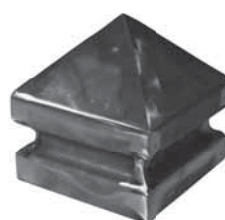

Copricolonna puntati in lamierino
Post caps in iron sheet



Art. 15.059.001 H. 40 x 40 mm
Art. 15.059.002 H. 50 x 50 mm
Art. 15.059.003 H. 60 x 60 mm
Art. 15.059.004 H. 70 x 70 mm
Art. 15.059.005 H. 80 x 80 mm
Art. 15.059.006 H. 100 x 100 mm
Art. 15.059.007 H. 120 x 120 mm
Art. 15.059.008 H. 150 x 150 mm

Art. 15.059.02 H.150 X L.150
Art. 15.059.03 H.120 X L.120
Art. 15.059.04 H.100 X L.100

Si raccomanda di zincare a caldo le sfere vuote in lamiera solo dopo averle forate
It's recommended to perforate the Hollow Spheres before the hot galvanization



Sfera vuota / Hollow sphere

Art. 15.059.05 □ 30x30 Ø 40 mm

Art. 15.059.06 □ 40x40 Ø 40 mm

Art. 15.059.07 □ 50x50 Ø 50 mm

Sfera vuota / Hollow sphere

Art. 15.059.08 □ 60x60 Ø 60 mm

Art. 15.059.09 □ 80x80 Ø 80 mm

Art. 15.059.10 □ 100x100 Ø 100 mm



Ruota leggera mod. T gola tonda
Light mod. T wheel-round groove

Art. 15.060 60 X 20 mm.
Art. 15.062 80 X 20 mm.
Art. 15.063 100 X 20 mm.
Art. 15.064 120 X 20 mm.
Art. 15.065 140 X 20 mm.



Ruota leggera mod. T a "V"
Light mod. T wheel-"V" shaped

Art. 15.072 60 X 20 mm.
Art. 15.074 80 X 20 mm.
Art. 15.075 100 X 20 mm.
Art. 15.076 120 X 20 mm.
Art. 15.077 140 X 20 mm.

Ruota pesante mod. T gola tonda
Heavy mod. T wheel-round groove

Art. 15.067 100 X 30 mm.
Art. 15.068 120 X 30 mm.
Art. 15.069 140 X 30 mm.
Art. 15.070 160 X 30 mm.

Ruota pesante mod. T a "V"
con doppio cuscinetto
Heavy mod. T wheel-"V" shaped
double bearing

Art. 15.079 100 X 30 mm.
Art. 15.080 120 X 30 mm.
Art. 15.081 140 X 30 mm.



Ruota con piastra a saldare gola tonda mod. T
Mod. "T" wheel with plate to weld-round groove

Art. 15.084 120 X 20 mm.
Art. 15.086 120 X 30 mm.



Ruota con piastra a saldare a "V" mod. T
Mod. T wheel with plate to weld-"V" shaped

Art. 15.088 120 X 20 mm.
Art. 15.091 140 X 30 mm.



Ruota a supporto interno mod. T gola tonda
Mod. T wheel with internal support-round groove

Art. 15.092 120 X 20 mm.
Art. 15.093 140 X 20 mm.
Art. 15.094 120 X 30 mm.
Art. 15.095 140 X 30 mm.



Ruota a supporto interno mod. T a "V"
Mod. T wheel with internal support-"V" shaped

Art. 15.096 120 X 20 mm.

**CIMASE, TERMINALI ED ELEMENTI VARI
ORNAMENTS FOR CARRIAGE GATES AND VARIOUS ELEMENTS**



Cardine a barra lunga
Long bar hinge

Zincato / Zinc-Plated
Art. 15.102 Ø 18 MA
Art. 15.103 Ø 22 MA

Cardine a muro
Hinge wall

Zincato / Zinc-Plated
Art. 15.107 Ø 18 MA
Art. 15.108 Ø 22 MA
Art. 15.109 Ø 27 MA

Cardine a saldare
Hinge -Welding hinge

Zincato / Zinc-Plated
Art. 15.113 Ø 18 MA
Art. 15.114 Ø 22 MA
Art. 15.115 Ø 27 MA

Cardine a regolazione ortogonale
(con vite a perno zincati)
*Right-angle adjustment hinge
(with galvanized screw and pin)*

Art. 15.116 Ø 18 MA
Art. 15.117 Ø 22 MA
Art. 15.118 Ø 27 MA

Zincato / Zinc-Plated

Art. 15.122 H.15 X L.60 mm.
Art. 15.123 H.20 X L.70 mm.
Art. 15.124 H.20 X L.80 mm.

Zincato / Zinc-Plated

Art. 15.128 H. 89 mm. Ø 20 mm.
Art. 15.129 H. 98 mm. Ø 23mm.
Art. 15.130 H.105 mm. Ø 28 mm.

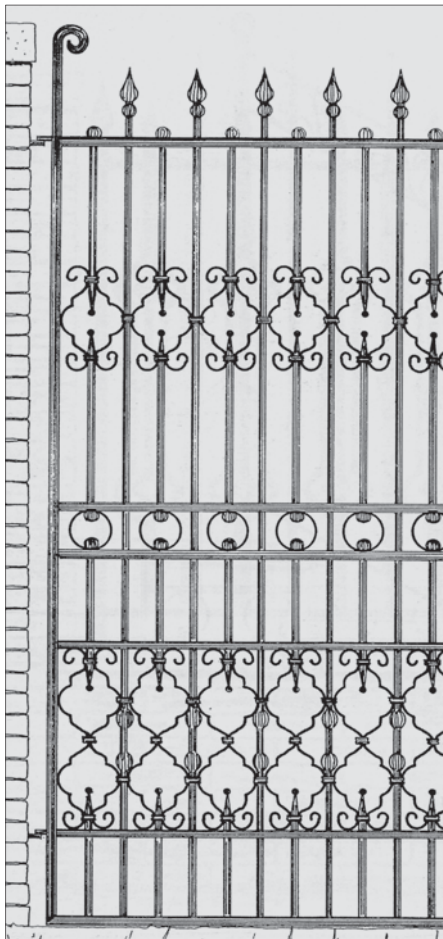

Zincato / Zinc-Plated

Art. 15.131 Cardine 18 MA per □30 - piastra 90 X 90 X 4
Art. 15.132 Cardine 22 MA per □35 - piastra 110 X 110 X 5
Art. 15.133 Cardine 27 MA per □40 - piastra 130 X 130 X 5



Zincato / Zinc-Plated

Art. 15.134 Cardine 18 MA regolabile per □30 - piastra 90 X 90 X 4
Art. 15.135 Cardine 22 MA regolabile per □35 - piastra 110 X 110 X 5
Art. 15.136 Cardine 27 MA regolabile per □40 - piastra 130 X 130 X 5

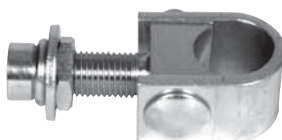

Zincato / Zinc-Plated

Art. 15.137 Cardine 18 MA regolabile per □30
Art. 15.138 Cardine 22 MA regolabile per □35
Art. 15.139 Cardine 27 MA regolabile per □40

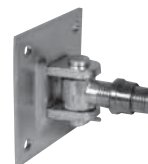

Zincato / Zinc-Plated

Art. 15.140 Cardine 18 MA con orecchie saldate su piastra 90 X 90 X 4
Art. 15.141 Cardine 22 MA con orecchie saldate su piastra 110 X 110 X 5
Art. 15.142 Cardine 27 MA con orecchie saldate su piastra 130 X 130 X 5

Accessori per cancelli in ferro battuto /

Perni di collegamento e guida superiore
Connection pins and upper guide

Accessories for wrought iron gates

Perni di collegamento e guida inferiore
Connection pins and lower guide



Art. 15.143
Perno sup. per cardine
Ø 24 per tub. □30X 3

Art. 15.144
Perno sup. per cardine
Ø 29 per tub. □35X 3

Art. 15.145
Perno sup. per cardine
Ø 34 per tub. □40X 3



Art. 15.146
Perno sup. per cardine
Ø 30 per ■30X 3

Art. 15.147
Perno sup. per cardine
Ø 35 per ■35X 3

Art. 15.148
Perno sup. per cardine
Ø 40 per ■40X 3



Art. 15.149
Perno inf. per cardine
Ø 19 A

Art. 15.150
Perno inf. per cardine
Ø 22A

Art. 15.151
Perno inf. per cardine
Ø 27A

Cerniere con cuscinetti a sfere
Hinge with ball bearings



H. 185 mm.
Art. 15.151.06
Ø 28 mm.



H. 100 mm.
Art. 15.151.07
Ø 20 mm.



H. 120 mm.
Art. 15.151.08
Ø 24 mm.



H. 145 mm.
Art. 15.151.09
Ø 30 mm.



H. 200 mm.
Art. 15.151.10
Ø 30 mm.



H. 80 mm.
Art. 15.151.01
Ø 12 mm.



H. 100 mm.
Art. 15.151.03
Ø 13,5 mm.

H. 140 mm.
Art. 15.151.02
Ø 16,5 mm.

H. 140 mm.
Art. 15.151.04
Ø 16,5 mm.



Spessore 6 mm.
Art. 15.151.11



Spessore 6 mm.
Art. 15.151.12

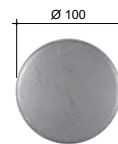

Spessore 8 mm.
Art. 15.151.13



Spessore 8 mm.
Art. 15.151.14

Tutte le parti di questo catalogo - foto comprese - sono di proprietà Euro-Fer. La riproduzione, anche parziale, è vietata in ogni forma e con ogni mezzo. / Every part of this catalogue - photos included - is Euro-Fer's property. All forms of copying are strictly prohibited.



Tutti i Fori sono Ø 11 / All Holes Ø 11

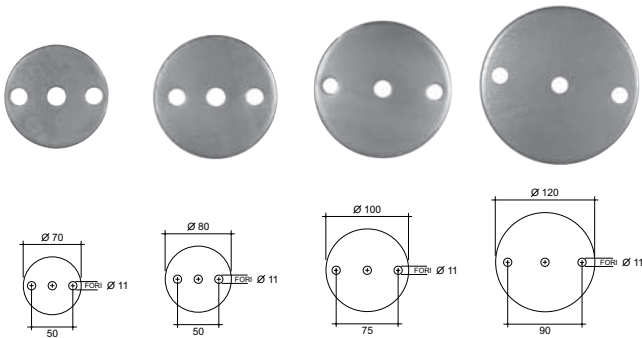

Spessore 6 mm.
Art. 15.151.15

Spessore 6 mm.
Art. 15.151.16

Spessore 8 mm.
Art. 15.151.17

Spessore 8 mm.
Art. 15.151.18

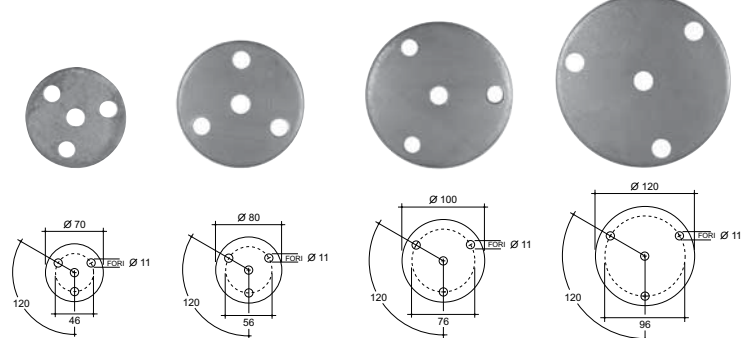

Spessore 6 mm.
Art. 15.151.19

Spessore 6 mm.
Art. 15.151.20

Spessore 8 mm.
Art. 15.151.21

Spessore 8 mm.
Art. 15.151.22

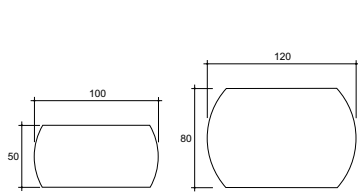

Spessore 8 mm.
Art. 15.151.23

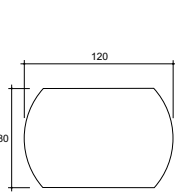

Spessore 8 mm.
Art. 15.151.24

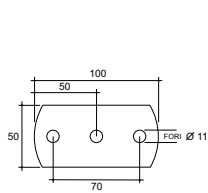

Spessore 8 mm.
Art. 15.151.25

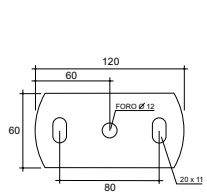

Spessore 8 mm.
Art. 15.151.26

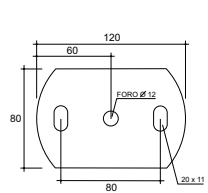

Spessore 8 mm.
Art. 15.151.27

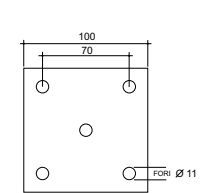

Spessore 6mm.
Art. 15.151.28

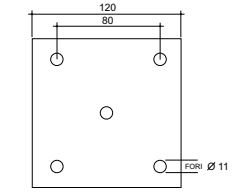

Spessore 8 mm.
Art. 15.151.29

Tutte le parti di questo catalogo - foto comprese - sono di proprietà Euro-Fer. La riproduzione, anche parziale, è vietata in ogni forma e con ogni mezzo. / Every part of this catalogue - photos included - is Euro-Fer's property. All forms of copying are strictly prohibited.

Articoli forniti in coppia / These pieces are furnished in pair

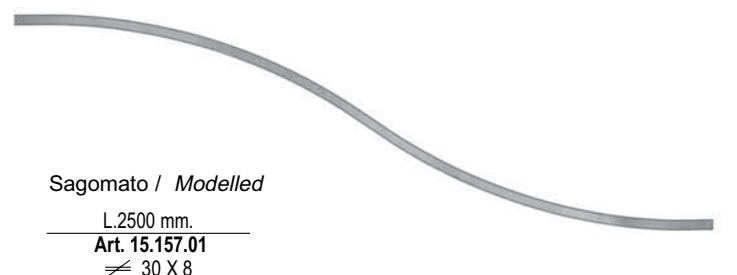
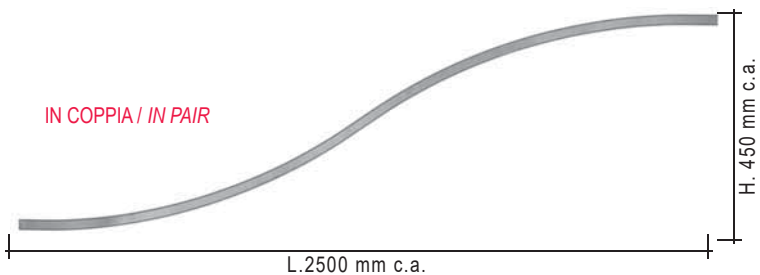
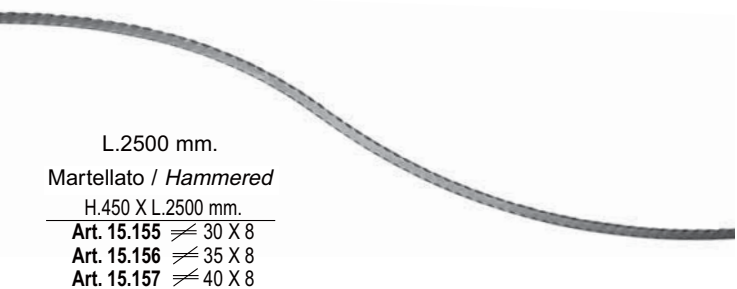
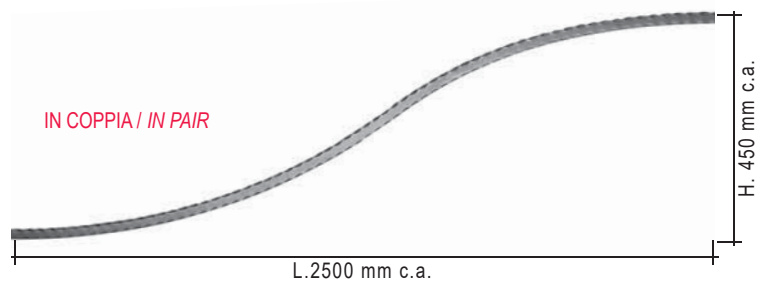
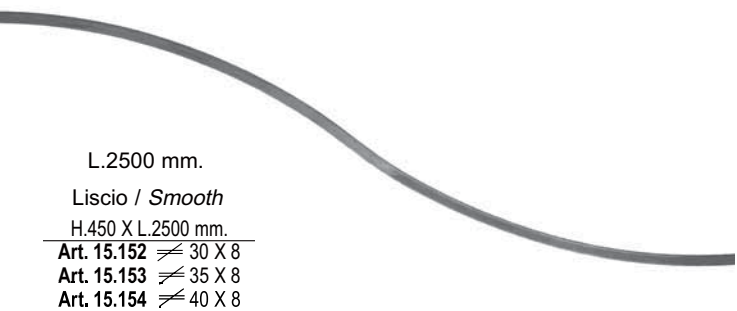
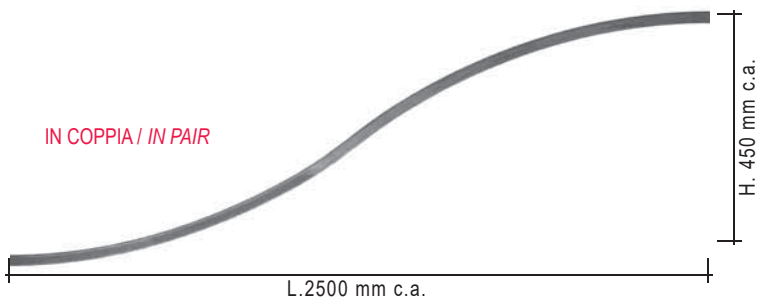
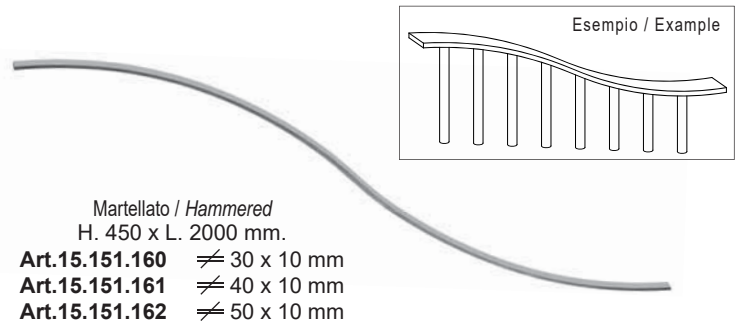
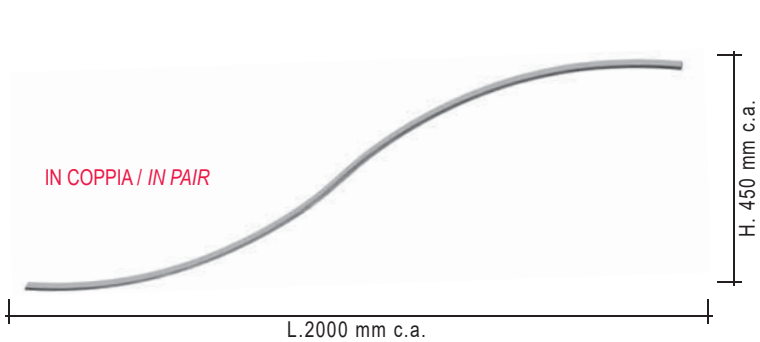
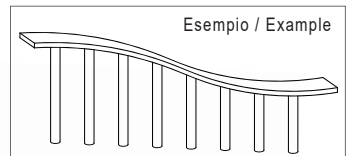
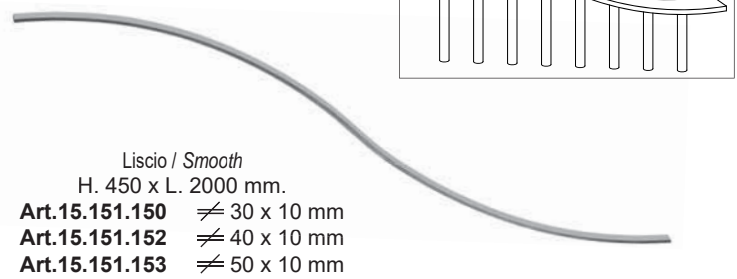
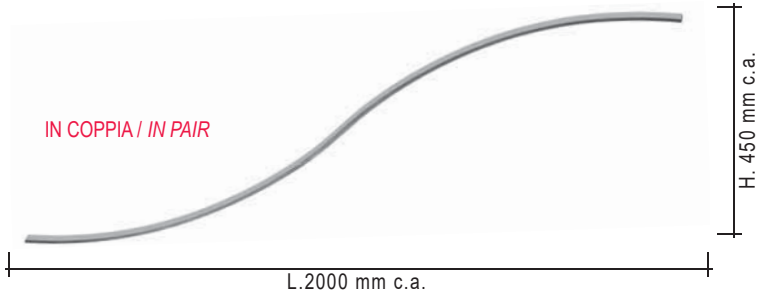
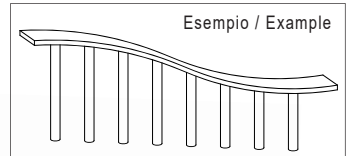

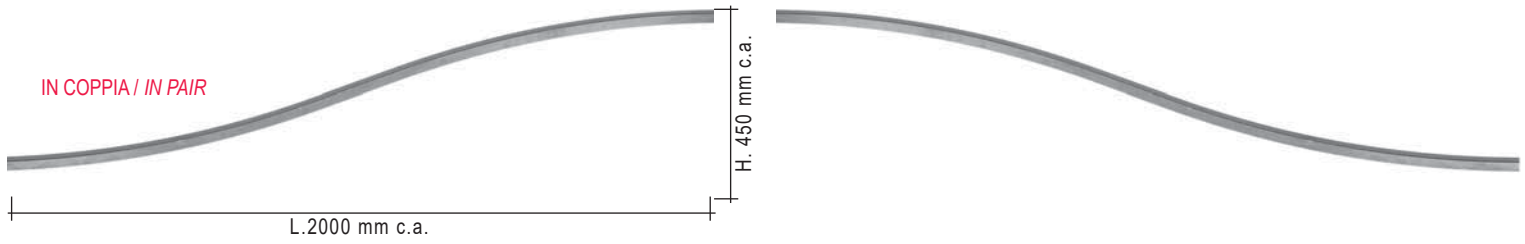

Tubolare Martellato / Hammered Bars

L.2000 mm.	
Art. 15.157.04	30 X 30
Art. 15.157.05	40 X 20

Tubolare Liscio / Smooth Bars

L.2000 mm.	
Art. 15.157.02	30 X 30
Art. 15.157.03	40 X 20

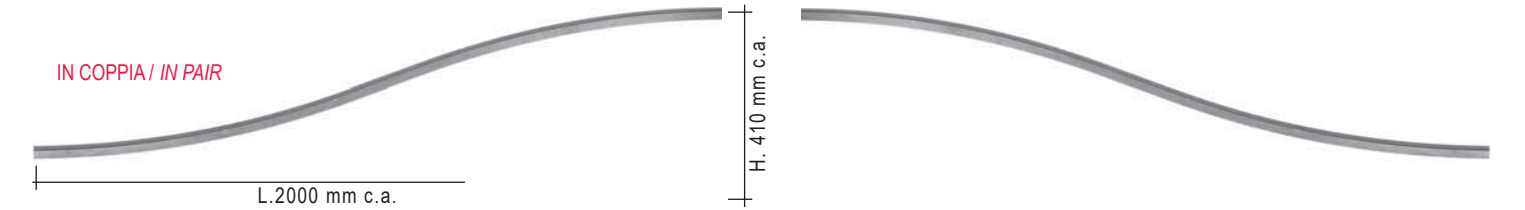

Martellato / Hammered

L.2000 mm.	
Art. 15.157.06	≠ 30 X 8
Art. 15.157.08	≠ 35 X 8
Art. 15.157.10	≠ 40 X 8

Sagomato / Modelled

L.2000 mm.	
Art. 15.157.12	≠ 30 X 8

Liscio / Smooth

L.2000 mm.	
Art. 15.157.14	≠ 30 X 8
Art. 15.157.15	≠ 35 X 8
Art. 15.157.16	≠ 40 X 8

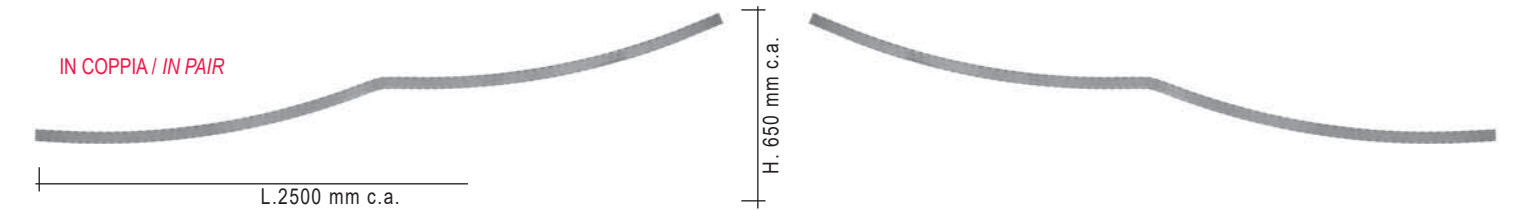

Martellato / Hammered

L.2500 mm.	
Art. 15.157.17	≠ 30 X 8
Art. 15.157.18	≠ 35 X 8
Art. 15.157.19	≠ 40 X 8

Sagomato / Modelled

L.2500 mm.	
Art. 15.157.20	≠ 30 X 8

Liscio / Smooth

L.2500 mm.	
Art. 15.157.21	≠ 30 X 8
Art. 15.157.22	≠ 35 X 8
Art. 15.157.23	≠ 40 X 8

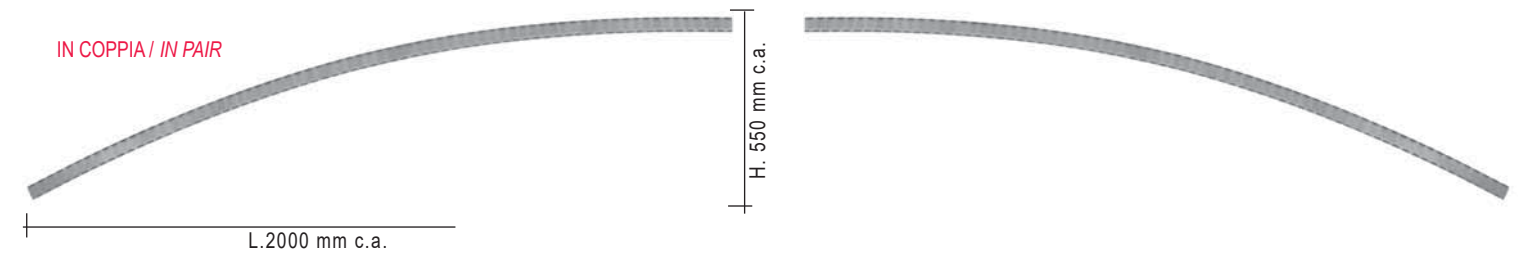

Martellato / Hammered

L.2000 mm.	
Art. 15.157.24	≠ 30 X 8
Art. 15.157.25	≠ 35 X 8
Art. 15.157.26	≠ 40 X 8

Mod. Scala / Scala Model

L.2000 mm.	
Art. 15.157.27	≠ 30 X 8
Art. 15.157.28	≠ 35 X 8
Art. 15.157.29	≠ 40 X 8

Liscio / Smooth

L.2000 mm.	
Art. 15.157.30	≠ 30 X 8
Art. 15.157.31	≠ 35 X 8
Art. 15.157.32	≠ 40 X 8

CIMASE, TERMINALI ED ELEMENTI VARI ORNAMENTS FOR CARRIAGE GATES AND VARIOUS ELEMENTS

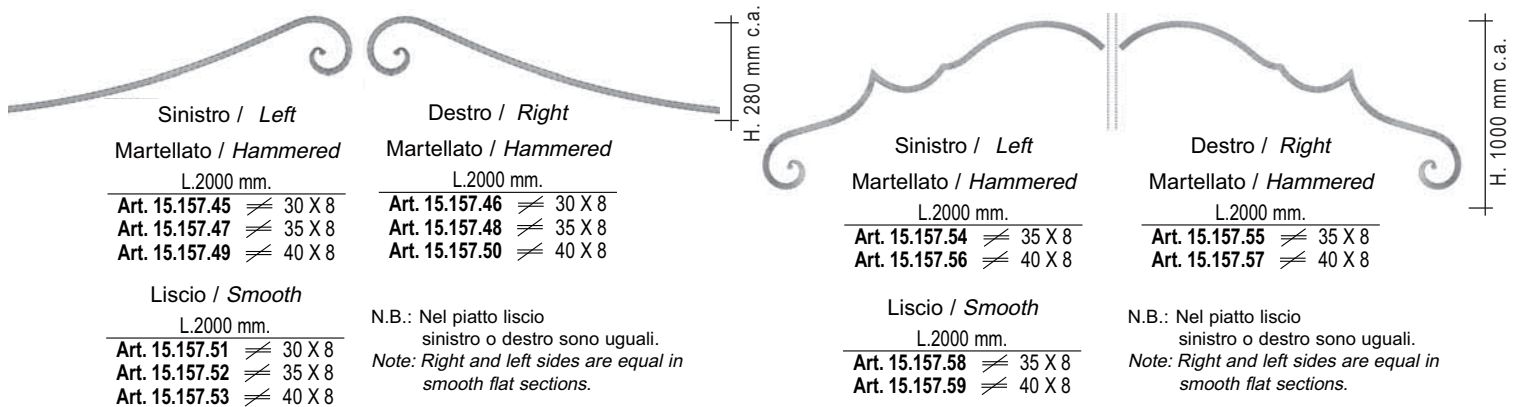
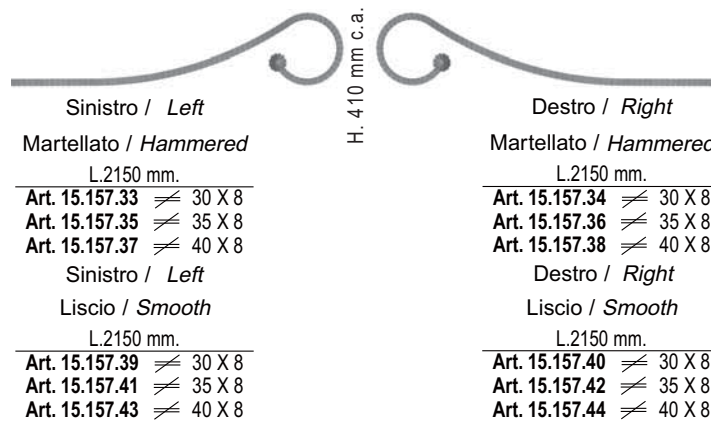

Tutte le parti di questo catalogo - foto comprese - sono di proprietà Euro-Fer. La riproduzione, anche parziale, è vietata in ogni forma e con ogni mezzo. / Every part of this catalogue - photos included - is Euro-Fer's property. All forms of copying are strictly prohibited.

CIMASE, TERMINALI ED ELEMENTI VARI ORNAMENTS FOR CARRIAGE GATES AND VARIOUS ELEMENTS

N.B.: Nel piatto liscio
sinistro o destro sono uguali.
Note: Right and left sides are equal in
smooth flat sections.

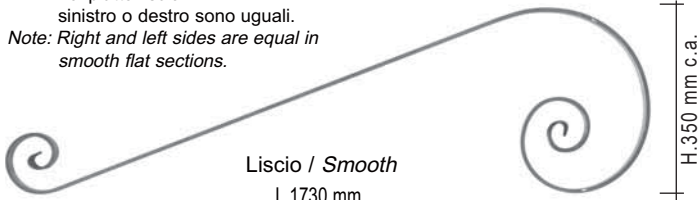

Liscio / Smooth
L.1730 mm.
Art. 15.157.60 ≙ 30 X 8
Art. 15.157.61 ≙ 35 X 10
Art. 15.157.62 ≙ 40 X 8

N.B.: Nel piatto liscio
sinistro o destro sono uguali.
Note: Right and left sides are equal in
smooth flat sections.

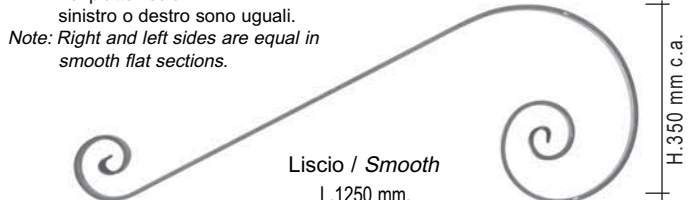

Liscio / Smooth
L.1250 mm.
Art. 15.157.63 ≙ 30 X 8
Art. 15.157.64 ≙ 35 X 10
Art. 15.157.65 ≙ 40 X 8

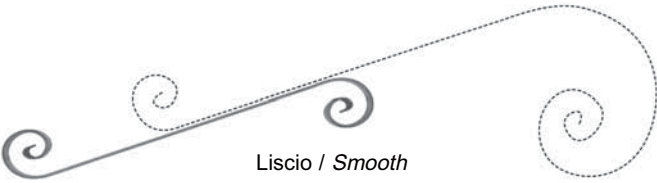

Liscio / Smooth
L.1150 mm.
Art. 15.157.66 ≙ 30 X 8
Art. 15.157.67 ≙ 35 X 10
Art. 15.157.68 ≙ 40 X 8



Sinistro / Left
Martellato / Hammered
L.2100 mm.
Art. 15.157.69 ≙ 35 X 8
Art. 15.157.71 ≙ 40 X 8

Destro / Right
Martellato / Hammered
L.2100 mm.
Art. 15.157.70 ≙ 35 X 8
Art. 15.157.72 ≙ 40 X 8

N.B.: Nel piatto liscio
sinistro o destro sono uguali.
Note: Right and left sides are equal in
smooth flat sections.

Liscio / Smooth
L.2100 mm.
Art. 15.157.73 ≙ 35 X 8
Art. 15.157.74 ≙ 40 X 8

N.B.: Nel piatto liscio
sinistro o destro sono uguali.
Note: Right and left sides are equal in
smooth flat sections.



Sinistro / Left
Martellato / Hammered
L.2000 mm.
Art. 15.157.75 ≙ 35 X 8
Art. 15.157.77 ≙ 40 X 8

Destro / Right
Martellato / Hammered
L.2000 mm.
Art. 15.157.76 ≙ 35 X 8
Art. 15.157.78 ≙ 40 X 8

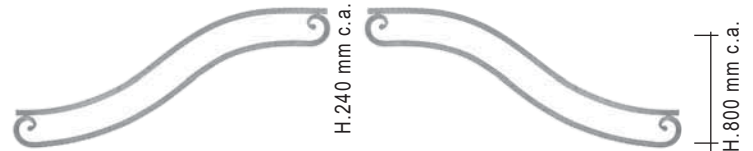

Sinistro / Left
Martellato / Hammered
L.2000 mm.
Art. 15.157.81 ≙ 35 X 8
Art. 15.157.83 ≙ 40 X 8

Destro / Right
Martellato / Hammered
L.2000 mm.
Art. 15.157.82 ≙ 35 X 8
Art. 15.157.84 ≙ 40 X 8

Liscio / Smooth
L.2000 mm.
Art. 15.157.79 ≙ 35 X 8
Art. 15.157.80 ≙ 40 X 8

N.B.: Nel piatto liscio
sinistro o destro sono uguali.
Note: Right and left sides are equal in
smooth flat sections.

Liscio / Smooth
L.2000 mm.
Art. 15.157.85 ≙ 35 X 8
Art. 15.157.86 ≙ 40 X 8

N.B.: Nel piatto liscio
sinistro o destro sono uguali.
Note: Right and left sides are equal in
smooth flat sections.



Sinistro / Left
Martellato / Hammered
L.1900 mm.
Art. 15.157.87 ≙ 35 X 8
Art. 15.157.89 ≙ 40 X 8

Destro / Right
Martellato / Hammered
L.1900 mm.
Art. 15.157.88 ≙ 35 X 8
Art. 15.157.90 ≙ 40 X 8



Sinistro / Left
Martellato / Hammered
L.2100 mm.
Art. 15.157.93 ≙ 35 X 8
Art. 15.157.95 ≙ 40 X 8

Destro / Right
Martellato / Hammered
L.2100 mm.
Art. 15.157.94 ≙ 35 X 8
Art. 15.157.96 ≙ 40 X 8

Liscio / Smooth
L.1900 mm.
Art. 15.157.91 ≙ 35 X 8
Art. 15.157.92 ≙ 40 X 8

N.B.: Nel piatto liscio
sinistro o destro sono uguali.
Note: Right and left sides are equal in
smooth flat sections.

Liscio / Smooth
L.2100 mm.
Art. 15.157.97 ≙ 35 X 8
Art. 15.157.98 ≙ 40 X 8

N.B.: Nel piatto liscio
sinistro o destro sono uguali.
Note: Right and left sides are equal in
smooth flat sections.

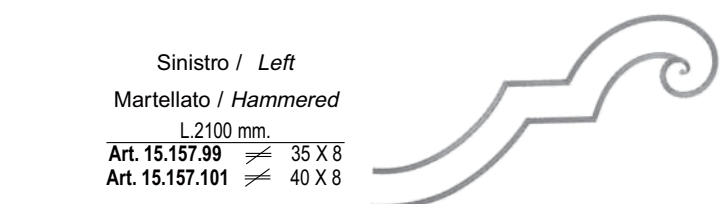

Sinistro / Left
Martellato / Hammered
L.2100 mm.
Art. 15.157.99 ≙ 35 X 8
Art. 15.157.101 ≙ 40 X 8

Liscio / Smooth
L.2100 mm.
Art. 15.157.103 ≙ 35 X 8
Art. 15.157.104 ≙ 40 X 8

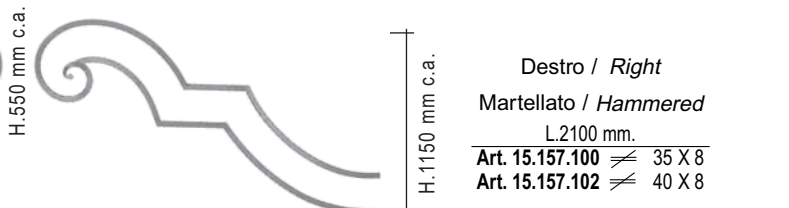

Destro / Right
Martellato / Hammered
L.2100 mm.
Art. 15.157.100 ≙ 35 X 8
Art. 15.157.102 ≙ 40 X 8

N.B.: Nel piatto liscio
sinistro o destro sono uguali.
Note: Right and left sides are equal in
smooth flat sections.

Pezzi forniti singolarmente / These pieces are furnished separately

CIMASE E CANCELLI PEDONALI



Liscio / Smooth

H.120 X L.1500 mm.

Art. 15.157.105 ≙ 30 X 8
Art. 15.157.106 ≙ 35 X 8
Art. 15.157.107 ≙ 40 X 8

Martellato / Hammered

H.120 X L.1500 mm.

Art. 15.157.108 ≙ 30 X 8
Art. 15.157.109 ≙ 35 X 8
Art. 15.157.110 ≙ 40 X 8



Tubolare Liscio

Smooth Bars

H.150 X L.1500 mm.

Art. 15.157.114 ≙ 30 X 30
Art. 15.157.115 ≙ 40 X 20

Tubolare Martellato

Hammered Bars

H.150 X L.1500 mm.

Art. 15.157.116 ≙ 30 X 30
Art. 15.157.117 ≙ 40 X 20



Liscio / Smooth

H.180 X L.1300 mm.

Art. 15.157.118 ≙ 30 X 8
Art. 15.157.119 ≙ 35 X 8
Art. 15.157.120 ≙ 40 X 8

Martellato / Hammered

H.180 X L.1300 mm.

Art. 15.157.121 ≙ 30 X 8
Art. 15.157.122 ≙ 35 X 8
Art. 15.157.123 ≙ 40 X 8



Liscio / Smooth

H.190 X L.1000 mm.

Art. 15.157.124 ≙ 30 X 8
Art. 15.157.125 ≙ 35 X 10
Art. 15.157.126 ≙ 40 X 8

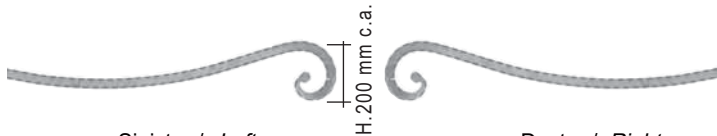

Sinistro / Left

Martellato / Hammered

H.200 X L.1000 mm.

Art. 15.157.127 ≙ 30 X 8
Art. 15.157.129 ≙ 35 X 8

Liscio / Smooth

H.200 X L.1000 mm.

Art. 15.157.131 ≙ 30 X 8
Art. 15.157.132 ≙ 35 X 8

H.200 mm c.a.

Destro / Right

Martellato / Hammered

H.200 X L.1000 mm.

Art. 15.157.128 ≙ 30 X 8
Art. 15.157.130 ≙ 35 X 8

N.B.: Nel piatto liscio
sinistro o destro sono uguali.
Note: Right and left sides are equal in
smooth flat sections.

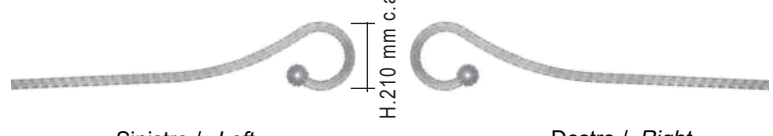

Sinistro / Left

Martellato / Hammered

H.210 X L.1000 mm.

Art. 15.157.133 ≙ 30 X 8
Art. 15.157.135 ≙ 35 X 8

Sinistro / Left

Liscio / Smooth

H.210 X L.1000 mm.

Art. 15.157.137 ≙ 30 X 8
Art. 15.157.138 ≙ 35 X 8

H.210 mm c.a.

Destro / Right

Martellato / Hammered

H.210 X L.1000 mm.

Art. 15.157.134 ≙ 30 X 8
Art. 15.157.136 ≙ 35 X 8

Destro / Right

Liscio / Smooth

H.210 X L.1000 mm.

Art. 15.157.193 ≙ 30 X 8
Art. 15.157.194 ≙ 35 X 8

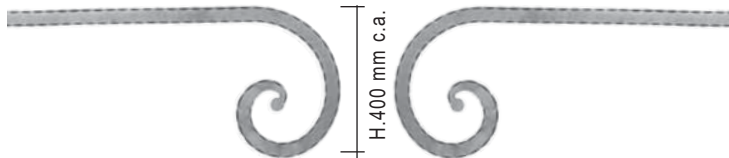

Sinistro / Left

Martellato / Hammered

H.400 X L.1000 mm.

Art. 15.157.139 ≙ 30 X 8
Art. 15.157.141 ≙ 35 X 8
Art. 15.157.143 ≙ 40 X 8

Liscio / Smooth

H.400 X L.1000 mm.

Art. 15.157.145 ≙ 30 X 8
Art. 15.157.146 ≙ 35 X 8
Art. 15.157.147 ≙ 40 X 8

H.400 mm c.a.

Destro / Right

Martellato / Hammered

H.400 X L.1000 mm.

Art. 15.157.140 ≙ 30 X 8
Art. 15.157.142 ≙ 35 X 8
Art. 15.157.144 ≙ 40 X 8

N.B.: Nel piatto liscio
sinistro o destro sono uguali.
Note: Right and left sides are equal in
smooth flat sections.



Sinistro / Left

Martellato / Hammered

H.300 X L.1000 mm.

Art. 15.157.148 ≙ 30 X 8
Art. 15.157.150 ≙ 35 X 8
Art. 15.157.152 ≙ 40 X 8

Liscio / Smooth

H.300 X L.1000 mm.

Art. 15.157.154 ≙ 30 X 8
Art. 15.157.155 ≙ 35 X 8
Art. 15.157.156 ≙ 40 X 8

H.300 mm c.a.

Destro / Right

Martellato / Hammered

H.300 X L.1000 mm.

Art. 15.157.149 ≙ 30 X 8
Art. 15.157.151 ≙ 35 X 8
Art. 15.157.153 ≙ 40 X 8

N.B.: Nel piatto liscio
sinistro o destro sono uguali.
Note: Right and left sides are equal in
smooth flat sections.



Pezzi forniti singolarmente / These pieces are furnished separately
CIMASE E CANCELLI PEDONALI



Sinistro / Left

Martellato / Hammered

H.200 X L.1000 mm.

Art. 15.157.157 ≙ 30 X 8
Art. 15.157.159 ≙ 35 X 8
Art. 15.157.161 ≙ 40 X 8



Destro / Right

Martellato / Hammered

H.200 X L.1000 mm.

Art. 15.157.158 ≙ 30 X 8
Art. 15.157.160 ≙ 35 X 8
Art. 15.157.162 ≙ 40 X 8



Sinistro / Left

Martellato / Hammered

H.400 X L.1000 mm.

Art. 15.157.166 ≙ 30 X 8
Art. 15.157.168 ≙ 35 X 8
Art. 15.157.170 ≙ 40 X 8



Destro / Right

Martellato / Hammered

H.400 X L.1000 mm.

Art. 15.157.167 ≙ 30 X 8
Art. 15.157.169 ≙ 35 X 8
Art. 15.157.171 ≙ 40 X 8

N.B.: Nel piatto liscio
sinistro o destro sono uguali.
Note: Right and left sides are equal in
smooth flat sections.

Liscio / Smooth

H.400 X L.1000 mm.

Art. 15.157.172 ≙ 30 X 8
Art. 15.157.173 ≙ 35 X 8
Art. 15.157.174 ≙ 40 X 8

N.B.: Nel piatto liscio
sinistro o destro sono uguali.
Note: Right and left sides are equal in
smooth flat sections.

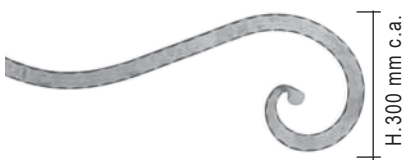

Sinistro / Left

Martellato / Hammered

H.300 X L.800 mm.

Art. 15.157.175 ≙ 30 X 8
Art. 15.157.177 ≙ 35 X 8
Art. 15.157.179 ≙ 40 X 8



Destro / Right

Martellato / Hammered

H.300 X L.800 mm.

Art. 15.157.176 ≙ 30 X 8
Art. 15.157.178 ≙ 35 X 8
Art. 15.157.180 ≙ 40 X 8

N.B.: Nel piatto liscio
sinistro o destro sono uguali.
Note: Right and left sides are equal in
smooth flat sections.

Liscio / Smooth

H.200 X L.500 mm.

Art. 15.157.190 ≙ 30 X 8
Art. 15.157.191 ≙ 35 X 8
Art. 15.157.192 ≙ 40 X 8

N.B.: Nel piatto liscio
sinistro o destro sono uguali.
Note: Right and left sides are equal in
smooth flat sections.



H. 220 mm c.a.

Sinistro / Left
Martellato / Hammered
H. 370 x L. 1500 mm.
Art. 15.157.200 \neq 30 x 8 mm

Liscio / Smooth
H. 370 x L. 1500 mm.
Art. 15.157.206 \neq 30 x 8 mm

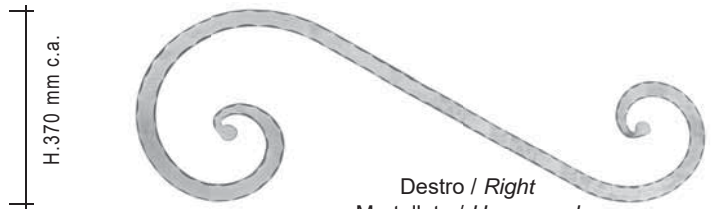

H. 370 mm c.a.

Destro / Right
Martellato / Hammered
H. 370 x L. 1500 mm.
Art. 15.157.201 \neq 30 x 8 mm

H. 220 mm c.a.

N.B.: Il piatto liscio sinistro
o destro sono uguali.
Note: Right and left sides are
equal in smooth flat sections.



H. 260 mm c.a.

Sinistro / Left
Martellato / Hammered
H. 460 x L. 1500 mm.
Art. 15.157.209 \neq 30 x 8 mm

Liscio / Smooth
H. 460 x L. 1500 mm.
Art. 15.157.215 \neq 30 x 8 mm

H. 460 mm c.a.

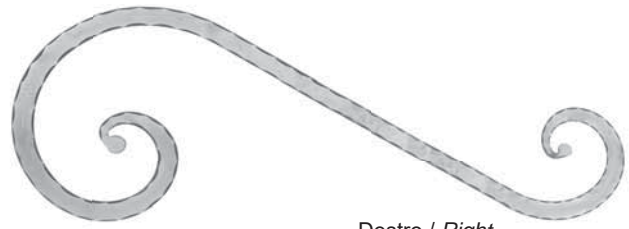

Destro / Right
Martellato / Hammered
H. 460 x L. 1500 mm.
Art. 15.157.210 \neq 30 x 8 mm

H. 260 mm c.a.

N.B.: Il piatto liscio sinistro
o destro sono uguali.
Note: Right and left sides are
equal in smooth flat sections.



H. 240 mm c.a.

Martellato / Hammered
H. 240 x L. 1500 mm.
Art. 15.157.218 \neq 30 x 8 mm

Liscio / Smooth
H. 240 x L. 1500 mm.
Art. 15.157.221 \neq 30 x 8 mm



H. 360 mm c.a.

Martellato / Hammered
H. 360 x L. 1500 mm.
Art. 15.157.224 \neq 30 x 8 mm

Liscio / Smooth
H. 360 x L. 1500 mm.
Art. 15.157.227 \neq 30 x 8 mm



Sinistro / Left
Martellato / Hammered
H. 400 x L. 2100 mm.
Art. 15.157.280 \neq 30 x 8 mm

Liscio / Smooth
H. 400 x L. 2100 mm.
Art. 15.157.286 \neq 30 x 8 mm

Destro / Right
Martellato / Hammered
H. 400 x L. 2100 mm.
Art. 15.157.281 \neq 30 x 8 mm

N.B.: Il piatto liscio sinistro
o destro sono uguali.
Note: Right and left sides are
equal in smooth flat sections.



≅ 70 X L.6 mm.
Art. 15.158 H. 300 mm.
Art. 15.159 H.2000 mm.
Art. 15.160 H.3000 mm.

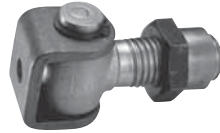

Zincato/Galvanized Zincato/Galvanized
Art. 15.161 **Art. 15.162**
A = 40 mm. A = 45 mm.
B = 60 mm. B = 45 mm.
C = 20 mm. C = 24 mm.



H. 160 X L.30 mm.
Art. 15.163



H. 130 X L.29 mm.
Art. 15.163.01



H. 100 X L.20 mm.
Art. 15.163.02



Perno / Pin
Ø 16mm

Forgiato a mano / Hand Forged
H. 328 x L. 110 mm
Art. 15.210 ≅ 8

Cardini e cerniere forgiati a mano per portali / Hand forged hinges for front doors



Forgiato a mano / Hand Forged
L. 740 mm
Art. 15.200 ≅ 40 x 8
fori / holes Ø 16,5 mm



Forgiato a mano / Hand Forged
L. 740 mm
Art. 15.201 ≅ 40 x 8
fori / holes Ø 16,5 mm



Forgiato / Forged
H. 525 x L. 105 mm
Art. 15.250 □ 30 mm



Forgiato / Forged
H. 610 x L. 180 mm
Art. 15.251 □ 30 mm
Art. 15.251.01 □ 25 mm



Forgiato / Forged
H. 920 x L. 220 mm
Art. 15.252 □ 30 mm
Art. 15.252.01 □ 25 mm



Forgiato / Forged
H. 650 x L. 285 mm
Art. 15.253 □ 30 mm





L.120 mm.
Art. 16.001



H.230 X L.60 mm.
Art. 16.002



H.270 X L.60 mm.
Art. 16.003

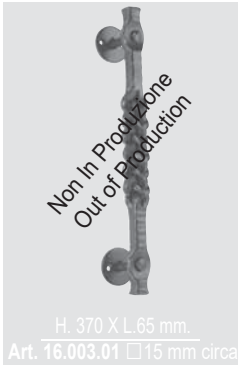

H. 370 X L.65 mm.
Art. 16.003.01 □ 15 mm circa



H.420 X L.75 mm.
Art. 16.003.02 Ø 20 mm circa



H.410 X L.100 mm.
Art. 16.003.03 Ø 25 mm circa



H.400 X L.90 mm
Art. 16.003.04



H.350 X L.75 mm
Art. 16.003.05

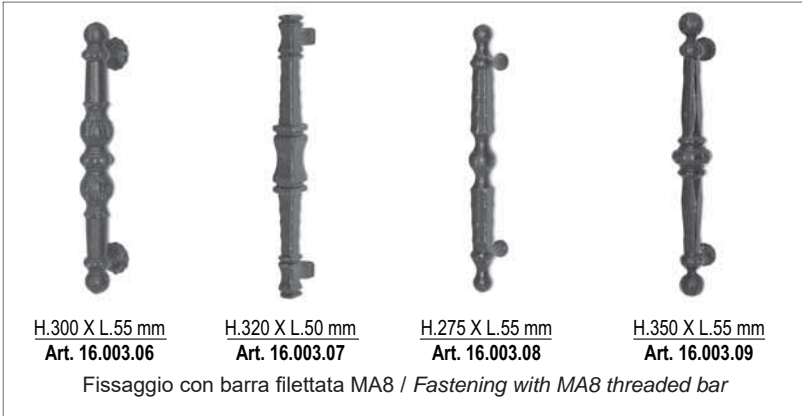

H.300 X L.55 mm
Art. 16.003.06

H.320 X L.50 mm
Art. 16.003.07

H.275 X L.55 mm
Art. 16.003.08

H.350 X L.55 mm
Art. 16.003.09



H.310 X L.50 mm
Art. 16.003.10
Forgiato / Forged



H.410 X L.70 mm
Art. 16.003.11
Forgiato / Forged

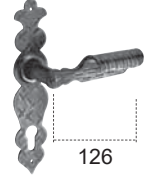

H.233 X L.50 mm.
Art. 16.004 (a coppia)

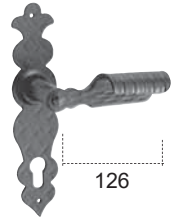

H.233 X L.50 mm.
Art. 16.005 (a coppia)



H.268 X L.49 mm.
Art. 16.006 (a coppia)

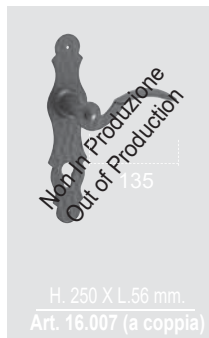

H. 250 X L.56 mm.
Art. 16.007 (a coppia)

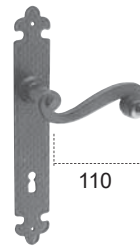

H.252 X L.38 mm.
Art. 16.008 (a coppia)

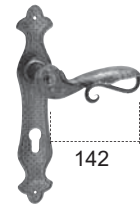

H.268 X L.49 mm.
Art. 16.009 (a coppia)



L.142 mm.
Art. 16.010 (a coppia)



L.142 mm.
Art. 16.011 (a coppia)



L.160 mm.
Art. 16.011.01 (a coppia)

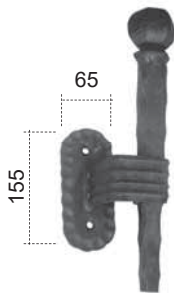

H.340 X L.100 mm.
Art. 16.011.02 (a coppia)



H.268 X L.49 mm.
Art. 16.012



H.250 X L.56 mm.
Art. 16.013 (a coppia)

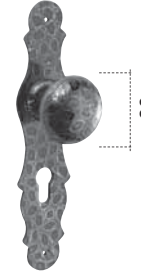

H.250 X L.56 mm.
Art. 16.014

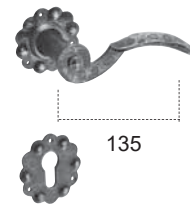

L.135 mm.
Art. 16.015 (a coppia)

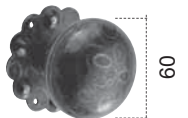

H.60 mm.
Art. 16.016

Borchia a 1 punta



Ø 12 mm.
Art. 16.018
Ø 15 mm.
Art. 16.018.01
Ø 20 mm.
Art. 16.018.02

Borchia a 2 punte

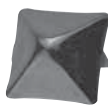

15 X 15 mm.
Art. 16.019
20 X 20 mm.
Art. 16.019.01



H. 370 X L.36 mm
Art. 16.020
Cremonese
Window-pull



H.230 X L.50 mm.
Art. 16.021 (a coppia)



L.110 mm.
Art. 16.022



H.170 mm.
Art. 16.022.01



H.90 mm.
Art. 16.022.02

Sporgenza d'ingombro 110 mm.
Wall protusion = 110 mm.



H.165 mm.
Art. 16.022.03
Sporgenza d'ingombro 55 mm.
Wall protusion = 55 mm.



H.200 mm.
Art. 16.022.04
Sporgenza d'ingombro 80 mm.
Wall protusion = 80 mm.



H.80 mm.
Art. 16.022.05
Sporgenza d'ingombro 40 mm.
Wall protusion = 40 mm.

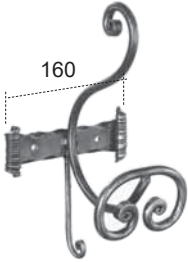

H.305 X L.160 mm.
Art. 16.022.06
Sporgenza d'ingombro 150 mm.
Wall protusion = 150 mm.

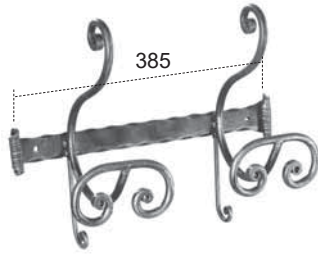

H.305 X L.385 mm.
Art. 16.022.07
Sporgenza d'ingombro 150 mm.
Wall protusion = 150 mm.

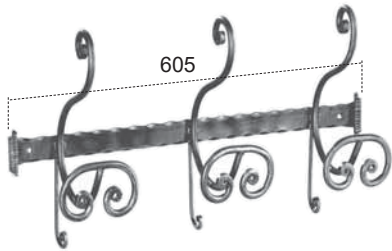

H.305 X L.605 mm.
Art. 16.022.08
Sporgenza d'ingombro 150 mm.
Wall protusion = 150 mm.

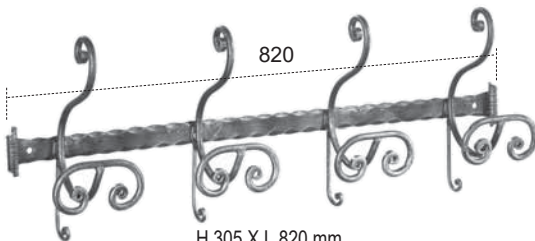

H.305 X L.820 mm.
Art. 16.022.09
Sporgenza d'ingombro 150 mm.
Wall protusion = 150 mm.

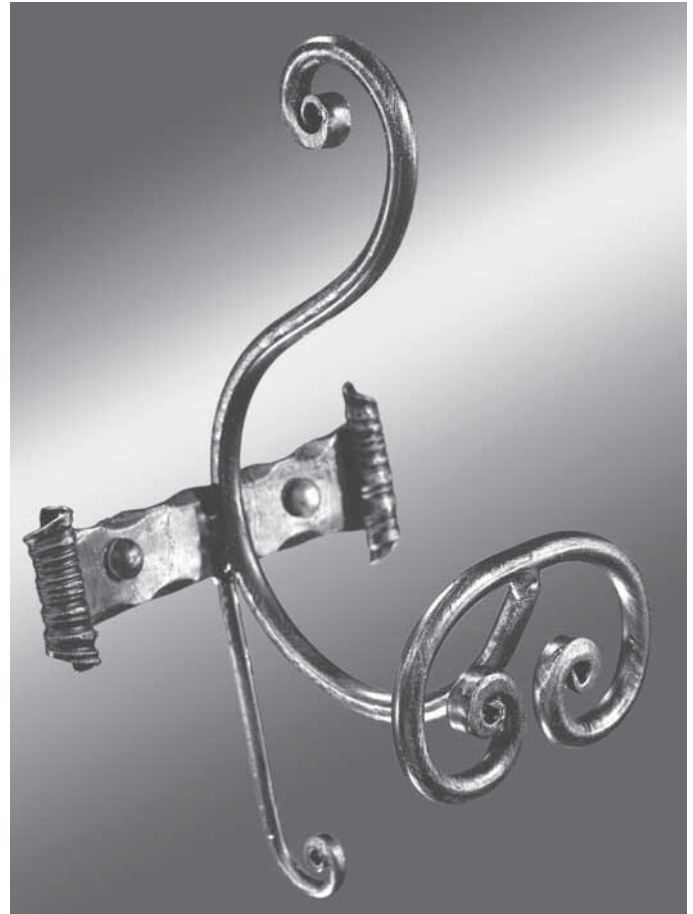

H 1860 mm.
Art. 16.022.10
Ingombro al pavimento Ø 600 mm.
Ingombro superiore Ø 500 mm.
Lower dimensions = 600 mm. Ø
Upper dimensions = 500 mm. Ø

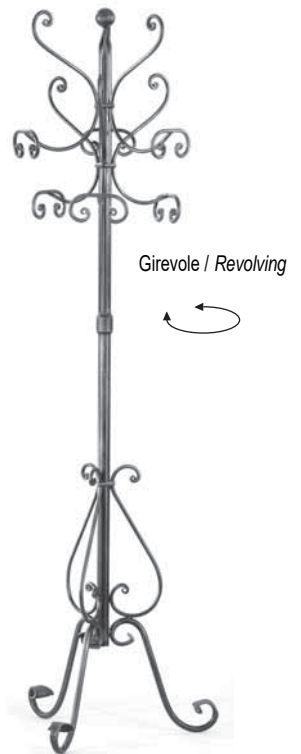

H 1830 mm.
Art. 16.022.11
Ingombro al pavimento Ø 600 mm.
Ingombro superiore Ø 500 mm.
Lower dimensions = 600 mm. Ø
Upper dimensions = 500 mm. Ø



N.	Spessore 4 mm.
0	Art. 16.022.12
1	Art. 16.022.13
2	Art. 16.022.14
3	Art. 16.022.15
4	Art. 16.022.16
5	Art. 16.022.17
6	Art. 16.022.18
7	Art. 16.022.19
8	Art. 16.022.20
9	Art. 16.022.21

Bloccaggio con 2 viti e tasselli da 10
Locking with no. 2 size 10 screws
and expansion bolts

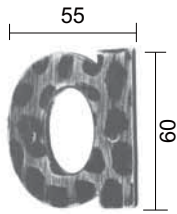

Spessore 4 mm.

A	Art. 16.022.22
B	Art. 16.022.23
C	Art. 16.022.24
D	Art. 16.022.25

Bloccaggio con 2 viti e tasselli da 10
Locking with no. 2 size 10 screws
and expansion bolts



H.100 X L.85 mm.
Profondità 40 mm.

Art. 16.022.26
Spessore piastra d'appoggio 3 mm.
Support plate thickness = 3 mm.



H.45 X L.250 mm.
Profondità 40 mm.

Art. 16.022.27

Spessore piastra d'appoggio 2 mm.
Support plate thickness = 2 mm.



Fuori Produzione
Out of Production
H.45 X L.250 mm.
Profondità 40 mm.
Art. 16.022.29

Spessore piastra d'appoggio 3 mm.
Support plate thickness = 3 mm.

Ottone / Brass



H.65 X L.100 mm.

Art. 16.022.30

Fissaggio con tasselli da 10 mm.
Fastening with size 10 expansion bolts



H.125 X L.130 mm.

Art. 16.022.31

Fissaggio con tasselli da 10 mm.
Fastening with size 10 expansion bolts



H.70 X L.120 mm.

Art. 16.022.32

Fissaggio con tasselli da 10 mm.
Fastening with size 10 expansion bolts



Ottone / Brass

Ø 120 Profondità 40 mm.

Art. 16.022.33

Fissaggio con barra filettata MA 6
Fastening with MA 6 threaded bar



Ø 140 Profondità 40 mm.

Art. 16.022.34

Fissaggio con barra filettata MA 6
Fastening with MA 6 threaded bar



H 140 Profondità 40 mm.

Art. 16.022.35

Fissaggio con barra filettata MA 6
Fastening with MA 6 threaded bar



Fuori Produzione
Out of Production

H.180 Profondità 30 mm.

Art. 16.022.36

Fissaggio con barra filettata MA6
Fastening with MA 6 threaded bar

Elementi in ottone / Knockers and Handles



H. 140 x L.140 mm

Art. 16.022.43

H. 100 x L.100 mm

Art. 16.022.44

H. 55 x L.55 mm

Art. 16.022.45

Fissaggio con barra filettata MA6 / Fastening with MA6 threaded bar



Elementi in ottone / Knockers and Handles

H 200 Profondità 60 mm.

Art. 16.022.39

Fissaggio con barra filettata MA 6
Fastening with MA 6 threaded bar

H 250 Profondità 60 mm.

Art. 16.022.40

Fissaggio con barra filettata MA 6
Fastening with MA 6 threaded bar



H 200 Profondità 60 mm.

Art. 16.022.41

Fissaggio con barra filettata MA 6
Fastening with MA 6 threaded bar

H 250 Profondità 60 mm.

Art. 16.022.42

Fissaggio con barra filettata MA 6
Fastening with MA 6 threaded bar

In coppia / In pair

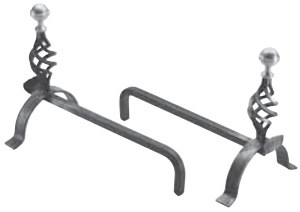

H.330 X L.420 mm.
Art. 16.023

In coppia / In pair

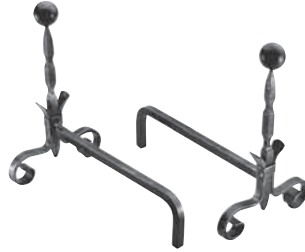

H.400 X L.420 mm.
Art. 16.025

In coppia / In pair



H.460 X L.420 mm.
Art. 16.027



H.630 mm.
Art. 16.024



H.600 mm.
Art. 16.026

In coppia / In pair



H.460 X L.610 mm.
Art. 16.028.01

In coppia / In pair



H.465 X L.530 mm.
Art. 16.028.03



H.870 X L.375 mm.
Art. 16.028.02



H.750 X L.360 mm.
Art. 16.028.05

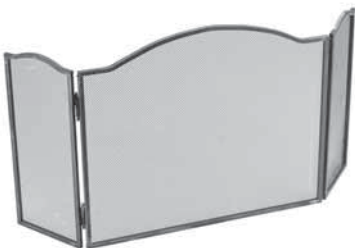

H.500 X L.1000 mm.
Art. 16.029



H.500 X L.900 mm.
Art. 16.030



H.480 X L.700 mm.
Art. 16.032



H.510 X L.1000 mm.
Art. 16.032.02
 Profondità appoggio 180 mm.
Support depth = 180 mm.



H.500 X L.1260 mm.
Art. 16.032.03

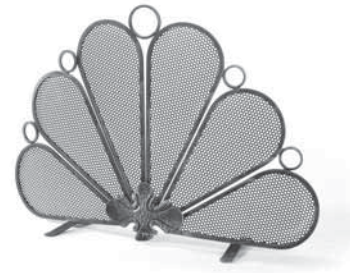

H.520 X L.745 mm.
Art. 16.032.04
 Profondità appoggio 180 mm.
Support depth = 180 mm.



H.180 X L.400 mm.
Art. 16.033
 Profondità appoggio 300 mm.
Support depth = 300 mm.



H.470 X L.435 mm.
Art. 16.033.01
 Profondità appoggio 250 mm.
Support depth = 250 mm.



H.410 X L.260 mm.
 Sporgenza d'ingombro 90 mm.
Wall protrusion = 90 mm
Art. 16.034 Rosso / Red
Art. 16.036 Metallizzato / Metallized
Art. 16.037 Verde / Green
Art. 16.038 Grigio ghisa / Cast iron grey
Art. 16.039 Nero / Black



H.465 X L.298 mm.
 Sporgenza d'ingombro 96 mm.
Wall protrusion = 96 mm
Art. 16.040 Rosso / Red
Art. 16.041 Bordeaux / Red-Wine
Art. 16.042 Metallizzato / Metallized



H.360 X L.275 mm.
Art. 16.045.01
 Sporgenza d'ingombro 115 mm.
Wall protrusion = 115 mm



H.410 X L.250 mm.
Art. 16.045.03 rosso / red
Art. 16.045.04 verde / green
 Sporgenza d'ingombro 100 mm.
Wall protrusion = 100 mm



Art. 16.046 Patina Oro / Gold Patina 0,2 lt.
Art. 16.047 Patina Rame / Copper Patina 0,2 lt.
Art. 16.049 Patina Argento / Silver Patina 0,2 lt.

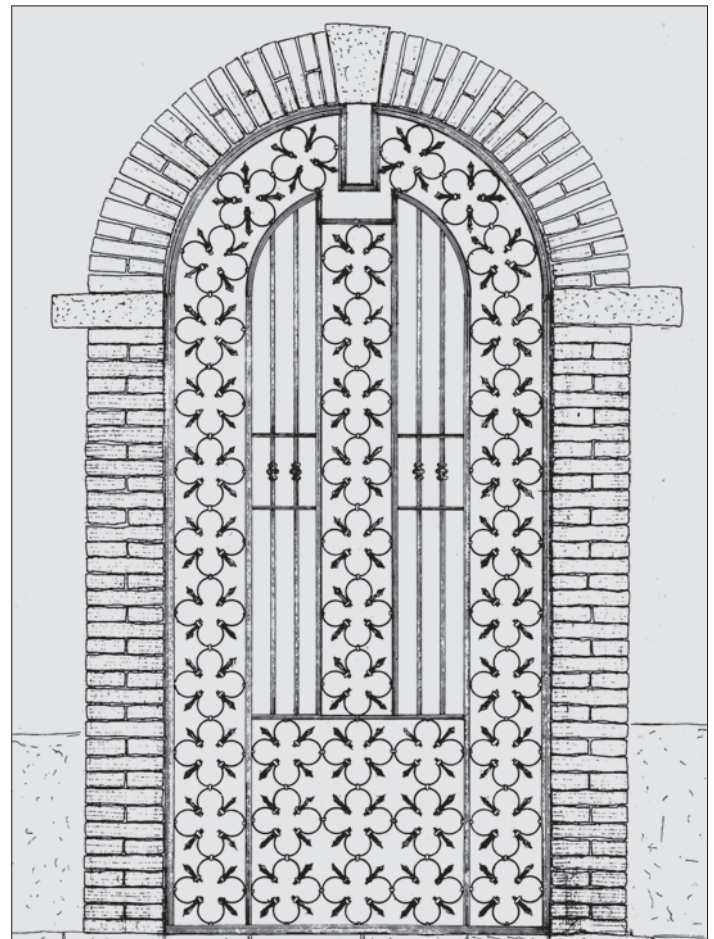

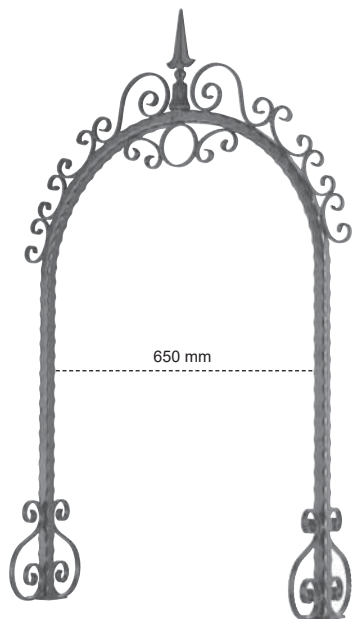

Martellato / *Hammered*
Art. 16.120

H 1340 X L.810 mm
Tubo □ 30 mm

Ricci Modello Scala / *Scala Model Scrolls*
≠ 14 X 6 mm

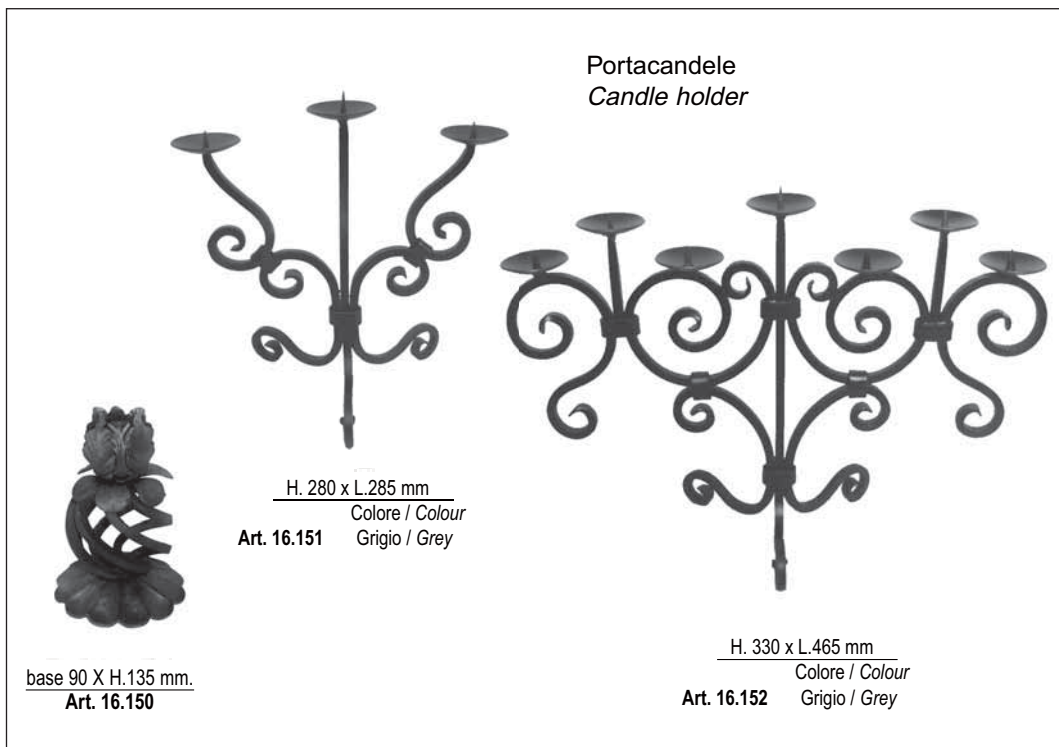

Portacandele
Candle holder

H. 280 x L.285 mm
Colore / *Colour*
Art. 16.151 Grigio / *Grey*

base 90 X H.135 mm.
Art. 16.150

H. 330 x L.465 mm
Colore / *Colour*
Art. 16.152 Grigio / *Grey*

H. 730 x L.680 mm
Colore / *Colour*
Art. 16.160 Grigio / *Grey*
Art. 16.160.01 Rame / *Copper*



H. 1100 x L.500 mm
Colore / *Colour*
Art. 16.161 Grigio / *Grey*
Art. 16.162 Rame / *Copper*



Finali per tubo tenda / Ends for curtain tube



H.150 X L.50 mm - Base Ø 20 mm
Art. 16.105 nero / black



H.240 X L.55 mm - Base Ø 20 mm
Art. 16.106 nero / black



H.205 X L.35 mm - Base Ø 20 mm
Art. 16.107 nero / black



H.215 X L.125 mm - Base Ø 20 mm
Art. 16.108 nero / black

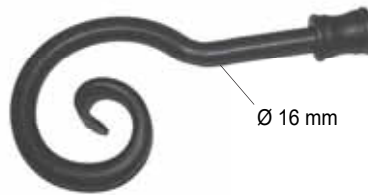

H.235 X L.110 mm - Base Ø 20 mm
Art. 16.109 nero / black

Ferma tenda / Curtain holder

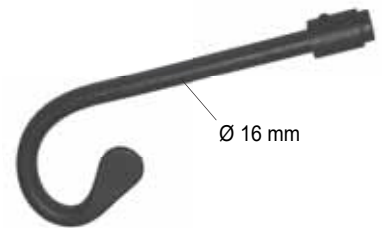

H.210 X 80 mm
Art. 16.110 nero / black

Tubo per tenda / Curtain tube



L.2000 - Ø 20 mm
Art. 16.115 nero / black

L.3000 - Ø 20 mm
Art. 16.116 nero / black

Anelli tenda / Curtain rings

pz. 20
Diam. 40 mm
Art. 16.111 nero / black



Ø esterno / out 40 mm
Ø interno / in 32 mm
Ø 4 mm

Fissaggio per supporto tubo / Wall fixing for tube support



Ø esterno / out 67 mm
Ø interno / in 17 mm

Art. 16.113C nero / black



Art. 16.113F

Supporto a parete per tubo / Wall support for tube



Per tubo / For tube - Ø 20 mm
Art. 16.112 nero / black

Supporto a sbalzo per tubo / Cantilever support for tube



L. 175 X 35 mm.
Per tubo / For tube - Ø 20 mm
Art. 16.113 nero / black

Installazione con supporto a sbalzo + finali per tubo / Installation with cantilever support + ends for curtain tube

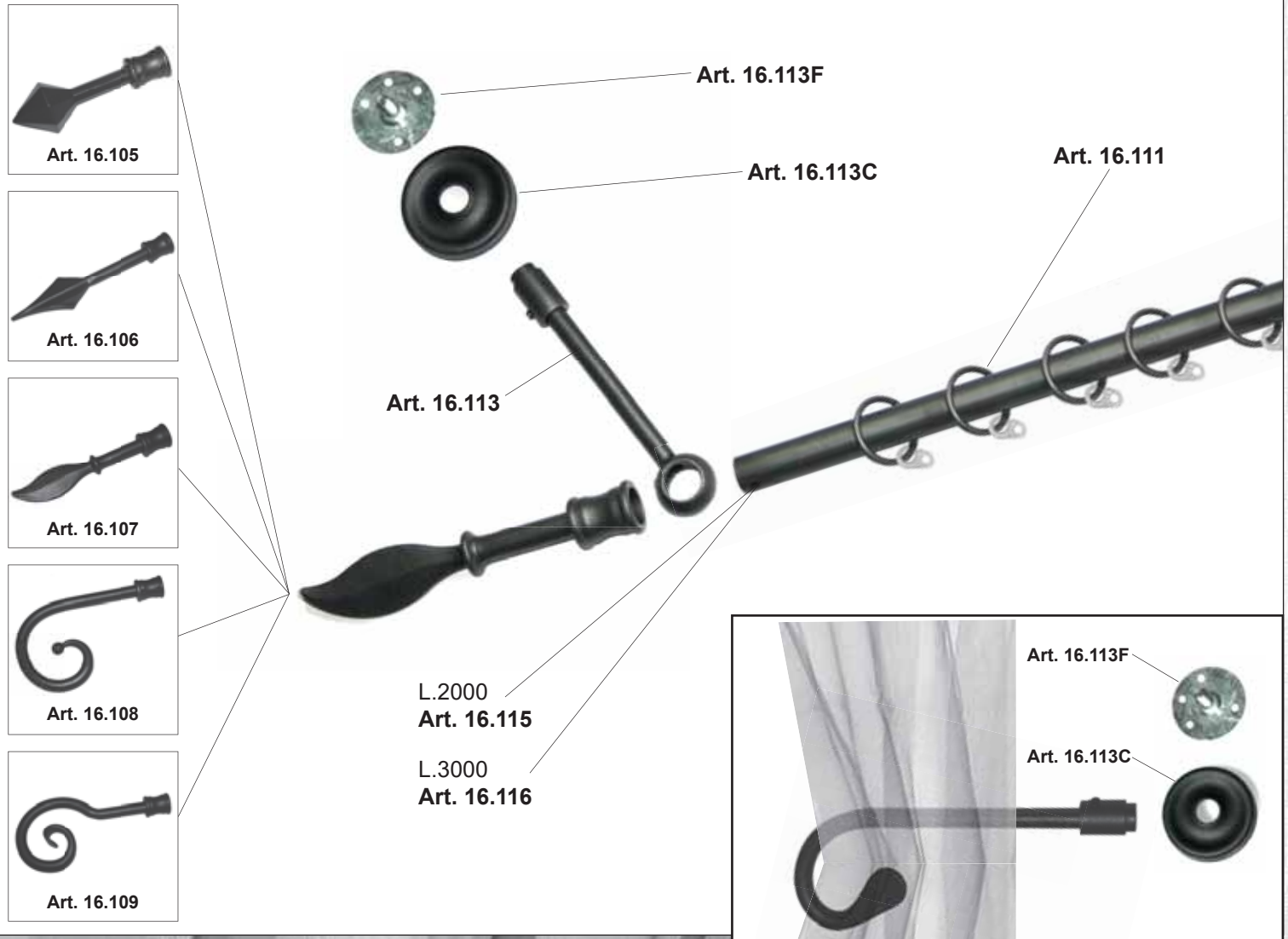

Installazione con supporto a parete per tubo
Installation with wall support for tube

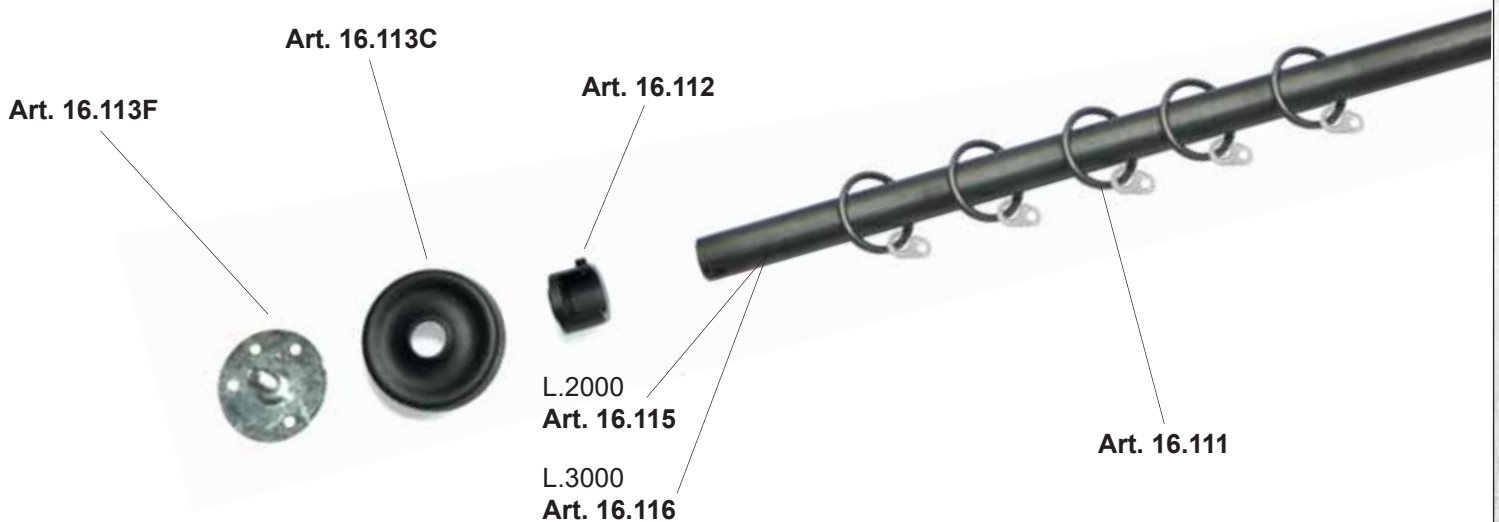



Nero / Black
Art. 16.200 H.1000 X L.900 mm.



Nero / Black
Art. 16.201 H.1000 X L.900 mm.



Nero / Black
Art. 16.203 H.1000 X L.900 mm.



Nero / Black
Art. 16.204 H.1000 X L.900 mm.

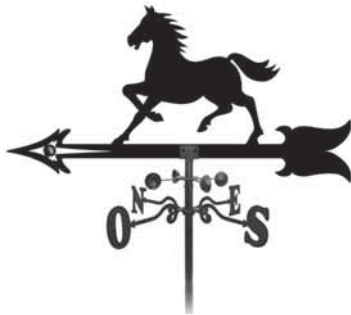

Nero / Black
Art. 16.205 H.1000 X L.900 mm.

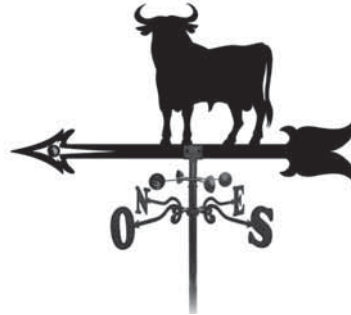

Nero / Black
Art. 16.206 H.1000 X L.900 mm.



Nero / Black
Art. 16.207 H.1000 X L.900 mm.



Nero / Black
Art. 16.208 H.1000 X L.900 mm.

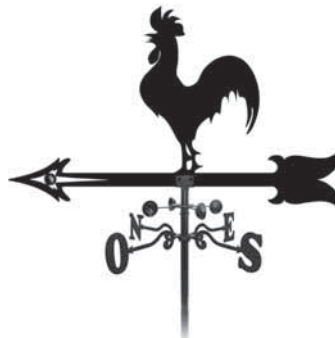

Nero / Black
Art. 16.209 H.1000 X L.900 mm.



Nero / Black
Art. 16.210 H.1000 X L.900 mm.



Nero / Black
Art. 16.212 H.1000 X L.900 mm.



Nero / Black
Art. 16.280
Base di supporto per segnvento
Fixing support



Nero / Black
Art. 16.284
Base di supporto a parete per segnvento
Walls support



Art. 16.285
Bussola per regolazione segnvento
Compass

- 1) Avvitare i punti cardinali con un cacciavite. Fare attenzione che le lettere siano nella giusta posizione.
- 2) Collocare l'anemometro sull'asta.
- 3) Introdurre la parte superiore del segna vento sull'asta ed avvitarla fino in fondo con un cacciavite.

- 1) Screw the cardinal points through a screwdriver. Check that the letters are in the right position.
- 2) Place the anemometer on the rod.
- 3) Insert the upper part of the weather vanes in the rod and screw it in through a screwdriver.

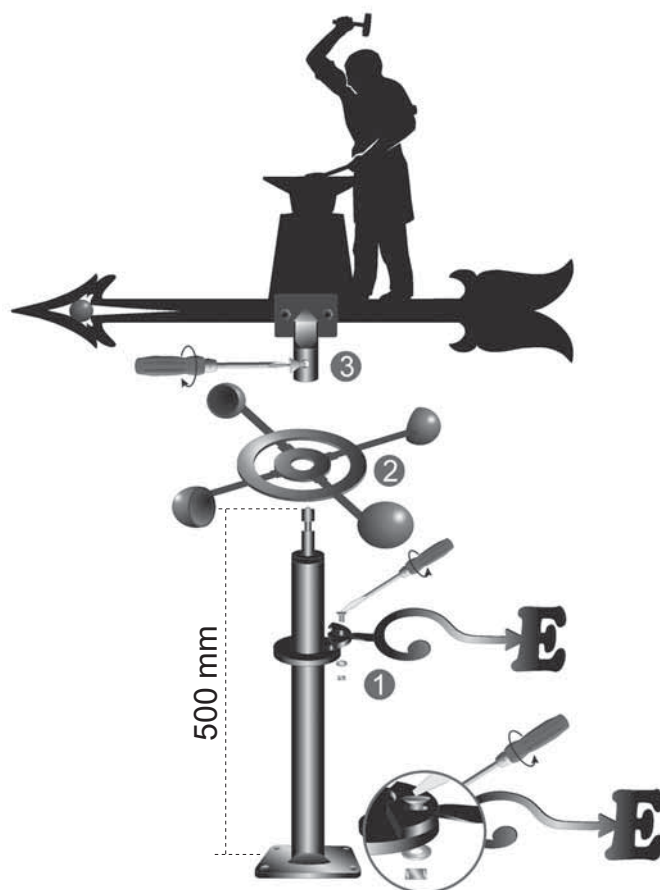

Istruzioni:

- 1) Nel collocare il supporto di fissaggio regolabile o quello da parete, bisogna tener presente che la parte piana dove si fissa il palo del segnavento deve essere perfettamente a livello.
- 2) Una volta fissato il supporto, avvitare il palo completamente montato tramite le 4 viti, senza però fissarle del tutto. Orientare quindi il segnavento servendosi della bussola (in tutte le bussole la freccia segna il nord magnetico). Con il braccio della lettera "N" rivolto verso nord, fissare con forza le viti.

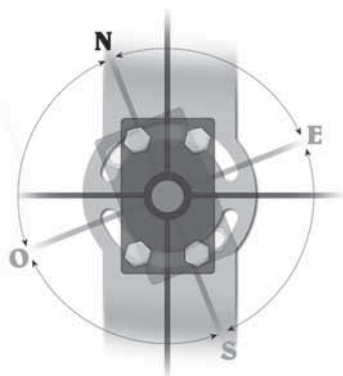

Art. 16.285

Instructions:

- 1) Either if you are placing the adjustable fixing support, or the walls one, you will need to consider that the flat surface where you place the pole of the weather vanes needs to be completely level.
- 2) Once the support has been fixed, screw the mounted pole using the 4 screws, but leave them slightly unscrewed then, orient the weather vanes through the compass (all compasses have the arrow pointing at the magnetic north) and with the compass arm of letter "N" pointing at the north, finally screw the screws completely to the end.

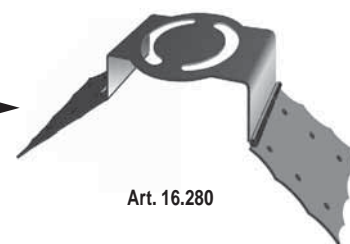
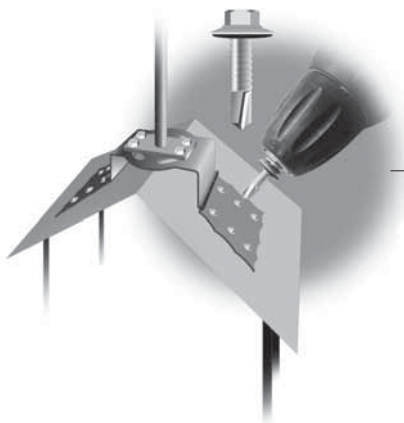

Art. 16.280



Liscio / Smooth
H.950 mm
Art. AL.05.045 □ 12 mm
Art. AL.05.045.01 □ 14 mm



Liscio / Smooth
H.220 X L.110 mm
Art. AL.01.022 ≠ 12 x 6 mm
Art. AL.01.023 ≠ 14 x 6 mm
H.290 X L.120 mm
Art. AL.01.028 ≠ 12 x 6 mm
Art. AL.01.029 ≠ 14 x 6 mm



Liscio / Smooth
H.290 X L.115 mm
Art. AL.01.066.01 ≠ 12 x 6 mm
Art. AL.01.067.01 ≠ 14 x 6 mm



Liscio / Smooth
H.360 X L.125 mm
Art. AL.01.072.01 ≠ 12 x 6 mm
Art. AL.01.073.01 ≠ 14 x 6 mm



Liscio / Smooth
H.100 X L.60 mm
Art. AL.01.086.05 ≠ 12 x 6 mm
Art. AL.01.086.06 ≠ 14 x 6 mm
H.125 X L.75 mm
Art. AL.01.086.07 ≠ 12 x 6 mm
Art. AL.01.086.08 ≠ 14 x 6 mm



Liscio / Smooth
H.120 X L.60 mm
Art. AL.01.099 ≠ 12 x 6 mm
Art. AL.01.099.01 ≠ 14 x 6 mm



Liscio / Smooth
H.250 X L.75 mm
Art. AL.01.105 ≠ 12 x 6 mm
Art. AL.01.105.01 ≠ 14 x 6 mm



H.130 x L.60 mm
Art. AL.13.052 Ø 12 mm



H.142 mm
Art. AL.13.080.02 Ø 28 mm



H.190 x L.68 mm
Art. AL.13.085 Ø 40 mm



H.160 x L.25 mm
Art. AL.13.089 □ 25 mm



H.190 x L.50 mm
Art. AL.13.094 □ 40 mm



H.120 mm
Art. AL.13.098.02 Ø 30 mm



H.180 x L.60 mm
Art. AL.13.103 Ø 15 mm



H.155 x L.60 mm
Art. AL.13.110.01 Ø 24 mm



Ferro fuso / Cast steel
H.65 x L.40 mm
Art. CS.13.142 □ 12,5



Ferro fuso / Cast steel
H.67 x L.45 mm
Art. CS.13.151 □ 12,5
Art. CS.13.152 □ 14,5
Art. CS.13.153 □ 16,5



Ferro fuso / Cast steel
H.38 x L.40 mm
Art. CS.13.900 □ 14,5
Art. CS.13.900.01 □ 16,5
Art. CS.13.900.02 □ 12,5



Ferro fuso / Cast steel
H.65 x L.40 mm
Art. CS.13.901 □ 14,5
Art. CS.13.901.01 □ 16,5
Art. CS.13.901.02 □ 12,5



Ghisa / Cast iron
H.45 x L.40 mm
Art. CI.13.902 □ 12,5
Art. CI.13.903 □ 14,5



Liscio / Smooth
H.115 X L.75 mm
Art. 01.094.01.ZF ≠ 14 x 6 mm



Tondo / Round
H.350 X L.150 mm.
Art. 01.369.ZF Ø 14
Art. 01.370.ZF Ø 16

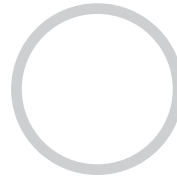

Liscio / Smooth
H.100 mm
Art. 02.031.ZF ≠ 12 x 6 mm



Liscio / Smooth
H.1500 mm
Art. 04.106.15.ZF Ø 14 mm

H.1500 mm
Art. 04.106.19.ZF Ø 16 mm

FORO QUADRO
SQUARE HOLE



H.2000 mm.

Art. 08.001.ZF fori / hole □ 14 INT.140 mm - n°14 fori / holes
Art. 08.002.ZF fori / hole □ 16 INT.150 mm - n°13 fori / holes
Art. 08.006.01.ZF fori / hole □ 12 INT.120 mm - n°16 fori / holes

FORO TONDO
ROUND HOLE



H.2000 mm.

Art. 08.023.ZF fori / hole Ø 14 INT.140 mm - n°14 fori / holes
Art. 08.024.ZF fori / hole Ø 16 INT.150 mm - n°13 fori / holes
Art. 08.025.ZF fori / hole Ø 18 INT.160 mm - n°12 fori / holes
Art. 08.029.01.ZF fori / hole Ø 12 INT.120 mm - n°16 fori / holes
Art. 08.115.ZF fori / hole Ø 14 INT.125 mm - n°15 fori / holes
Art. 08.116.ZF fori / hole Ø 16 INT.125 mm - n°15 fori / holes

FORO QUADRO
SQUARE HOLE



INT.125

15 Fori per barra
15 Holes for bar

H.2000 mm. Foro □ 12
Art. 08.059.ZF ≠ 30 x 8
Art. 08.063.ZF ≠ 40 x 8



Piatto Mezzo Tondo /
Half-Round Flat
H.6000 mm.

Art. 12.059.01.ZF \neq 30x8
Art. 12.063.01.ZF \neq 40x8
Art. 12.064.01.ZF \neq 40x10
Art. 12.066.01.ZF \neq 50x10



Sagomato / Contoured
H.6000 mm.

Art. 12.085.ZF \neq 50 x 14
Art. 12.085.01.ZF \neq 40 x 12
Art. 12.085.02.ZF \neq 45 x 12



Barra per Fascette /
Collar Bars
H.4000 mm.

Art. 12.118.ZF \neq 14x4

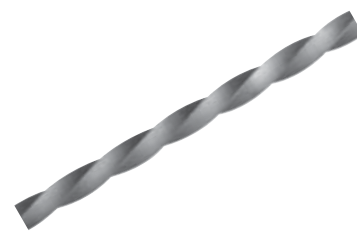

H.6000 mm.

Art. 12.158.ZF \square 12x12 mm.
Art. 12.159.ZF \square 14x14 mm.



Quadro Martellato / Hammered Square
H.6000 mm.

Art. 12.182.ZF \square 12x12 mm.
Art. 12.183.ZF \square 14x14 mm.



Tubo Martellato / Tube Hammered
H.6000 mm.

Art. 12.238.ZF \square 40x40 x 2.5 mm.
Art. 12.240.ZF \square 30x30 x 2.5 mm.



H.125 X L.60 mm.
Art. 13.077.ZF \varnothing 32 mm



H.155 X L.65 mm.
Art. 13.080.ZF \varnothing 16 mm



H.39 x L.49 mm.
Art. 13.135.ZF \varnothing 12,5 mm
Art. 13.136.ZF \varnothing 14,5 mm
Art. 13.137.ZF \varnothing 16,5 mm



H.67 x L.40 mm.
Art. 13.138.ZF \varnothing 12,5 mm
Art. 13.139.ZF \varnothing 14,5 mm
Art. 13.140.ZF \varnothing 16,5 mm



Borchie Svasate /
Countersunk Ironstud
H.39 X L.40 mm.
Art. 13.137.B.ZF \varnothing 16,5 mm

Nuove Borchie in Tubo /
New Studs in Tube



H.36 x L.37 mm.
Art. 13.135.E.ZF \varnothing 12,5 mm
Art. 13.136.E.ZF \varnothing 14,5 mm
Art. 13.137.E.ZF \varnothing 16,5 mm

H.63 x L.37 mm.
Art. 13.138.E.ZF \varnothing 12,5 mm
Art. 13.139.E.ZF \varnothing 14,5 mm
Art. 13.140.E.ZF \varnothing 16,5 mm

H.67 x L. 40 mm
Art. TB.13.139.ZF \varnothing 14,5
Art. TB.13.140.ZF \varnothing 16,5



H.67 x L.40 mm.
Art. 13.142.ZF □ 12,5 mm



H.67 X L.45 mm.
Art. 13.148.ZF Ø 16,5 mm



H.25 x L.35 mm.
Art. 13.167.ZF Ø 12,5 mm
Art. 13.167.02.ZF Ø 16,5 mm

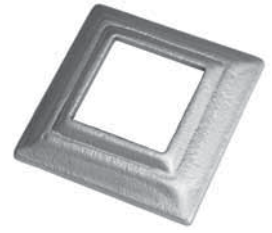

H.80 x 80 H. 20 mm.
Art. 13.319.ZF foro □ 30,5 mm
Art. 13.320.ZF foro □ 35,5 mm
Art. 13.321.ZF foro □ 40,5 mm

H.67 x L.45 mm.
Art. 13.152.ZF □ 14,5 mm

H.60 x 60 H. 20 mm.
Art. 13.322.ZF foro □ 25,5 mm
Art. 13.323.ZF foro □ 30,5 mm



□ 100x100 mm
Art. 13.311.ZF sede/space □ 30x30 mm



□ 100x100 mm
Art. 13.313.ZF foro/hole □ 30x30 mm



Ferro fuso / Cast steel/
H.38 x L.40 mm
Art. CS.13.900.ZF □ 14,5



Ferro fuso / Cast steel/
H.65 x L.40 mm
Art. CS.13.901.ZF □ 14,5
Art. CS.13.901.01.ZF □ 16,5



Copricolonna / Post Caps

- Art. 15.052.ZF** □ 30x30 mm
Art. 15.053.ZF □ 40x40 mm
Art. 15.054.ZF □ 50x50 mm
Art. 15.055.ZF □ 60x60 mm

Copricolonna / Post Caps

- Art. 15.056.ZF** □ 80x80 mm
Art. 15.057.ZF □ 100x100 mm
Art. 15.058.ZF □ 120x120 mm
Art. 15.059.ZF □ 150x150 mm

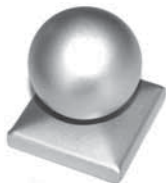

Sfera vuota / Hollow sphere

- Art. 15.059.05.ZF** □ 30x30 Ø 40 mm
Art. 15.059.06.ZF □ 40x40 Ø 40 mm
Art. 15.059.07.ZF □ 50x50 Ø 50 mm

Sfera vuota / Hollow sphere

- Art. 15.059.08.ZF** □ 60x60 Ø 60 mm
Art. 15.059.09.ZF □ 80x80 Ø 80 mm
Art. 15.059.10.ZF □ 100x100 Ø 100 mm

Liscio / Smooth

Tondo.ZF.	6x6000 mm
Tondo.ZF.	8x6000 mm
Tondo.ZF.	10x6000 mm
Tondo.ZF.	12x6000 mm

Liscio / Smooth

Tondo.ZF.	14x6000 mm
Tondo.ZF.	16x6000 mm
Tondo.ZF.	18x6000 mm
Tondo.ZF.	20x6000 mm

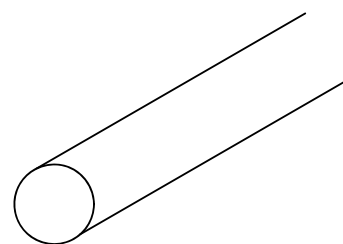
Liscio / Smooth
H.6000 mm.

Piatto.ZF	≠ 20 x 3
Piatto.ZF	≠ 20 x 4
Piatto.ZF	≠ 20 x 5
Piatto.ZF	≠ 20 x 10
Piatto.ZF	≠ 25 x 3
Piatto.ZF	≠ 25 x 4
Piatto.ZF	≠ 25 x 5

NEW

Liscio / Smooth
H.6000 mm.

Piatto.ZF	≠ 30 x 3
Piatto.ZF	≠ 30 x 4
Piatto.ZF	≠ 30 x 5
Piatto.ZF	≠ 30 x 6
Piatto.ZF	≠ 30 x 8
Piatto.ZF	≠ 30 x 10
Piatto.ZF	≠ 30 x 20

NEW

Liscio / Smooth
H.6000 mm.

Piatto.ZF	≠ 40 x 4
Piatto.ZF	≠ 40 x 5
Piatto.ZF	≠ 40 x 8
Piatto.ZF	≠ 40 x 10
Piatto.ZF	≠ 50 x 5
Piatto.ZF	≠ 50 x 8
Piatto.ZF	≠ 50 x 10
Piatto.ZF	≠ 60 x 5
Piatto.ZF	≠ 80 x 5

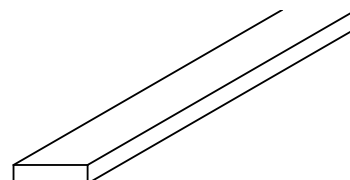
Liscio / Smooth
H.6000 mm.

Angolare.ZF	┌ 20 x 20 x 3
Angolare.ZF	┌ 25 x 25 x 4
Angolare.ZF	┌ 30 x 30 x 3
Angolare.ZF	┌ 30 x 30 x 5
Angolare.ZF	┌ 35 x 35 x 5

Liscio / Smooth
H.6000 mm.

Angolare.ZF	┌ 40 x 40 x 5
Angolare.ZF	┌ 45 x 45 x 5
Angolare.ZF	┌ 50 x 50 x 5
Angolare.ZF	┌ 60 x 60 x 5

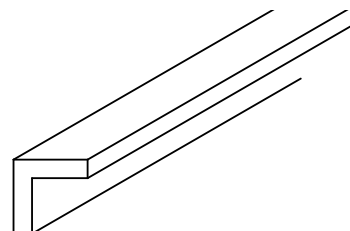
Liscio / Smooth
H.6000 mm.

Profilo.ZF	T 30 x 30 x 4
Profilo.ZF	T 35 x 35 x 4,5
Profilo.ZF	T 40 x 40 x 5
Profilo.ZF	T 50 x 50 x 6

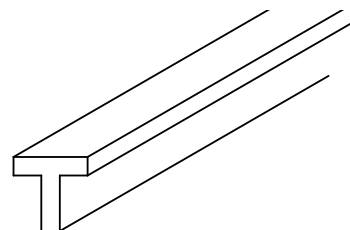

Liscio / Smooth

Quadro.ZF	□ 14x6000 mm
Quadro.ZF	□ 16x6000 mm

Liscio / Smooth

Quadro.ZF	□ 10x6000 mm
Quadro.ZF	□ 12x6000 mm
Quadro.ZF	□ 20x6000 mm

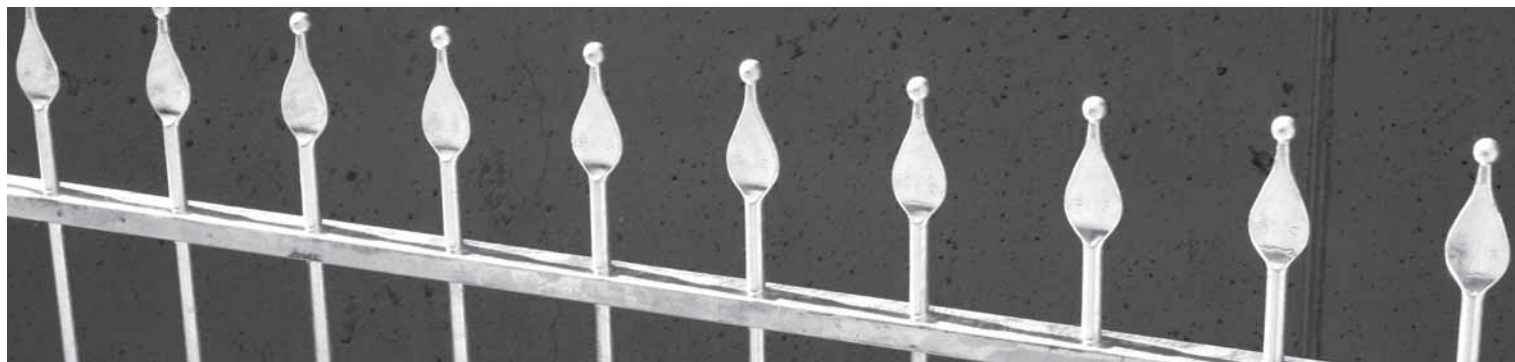
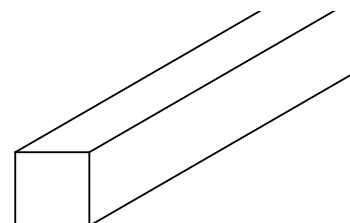

Art. LB1000X2000.20/10.ZF	Lamiera Bugnata / <i>Teardrop patterned steel sheet</i> 1000x2000mm sp. 20/10
Art. LB1000X2000.25/10.ZF	Lamiera Bugnata / <i>Teardrop patterned steel sheet</i> 1000x2000mm sp. 25/10
Art. LB1000X2000.30/10.ZF	Lamiera Bugnata / <i>Teardrop patterned steel sheet</i> 1000x2000mm sp. 30/10
Art. LB1250X2500.20/10.ZF	Lamiera Bugnata / <i>Teardrop patterned steel sheet</i> 1250x2500mm sp. 20/10
Art. LB1250X2500.25/10.ZF	Lamiera Bugnata / <i>Teardrop patterned steel sheet</i> 1250x2500mm sp. 25/10
Art. LB1250X2500.30/10.ZF	Lamiera Bugnata / <i>Teardrop patterned steel sheet</i> 1250x2500mm sp. 30/10
Art. LB1500X3000.25/10.ZF	Lamiera Bugnata / <i>Teardrop patterned steel sheet</i> 1500x3000mm sp. 25/10
Art. LB1500X3000.30/10.ZF	Lamiera Bugnata / <i>Teardrop patterned steel sheet</i> 1500x3000mm sp. 30/10

**“A seconda delle diponibilita' del magazzino la bugna puo' essere tronca oppure affusolata”
“Depending on the availability of the warehouse the drop could be truncated or tapered”**

Lamiera Bugnata Tronca /
Teardrop patterned steel sheet (truncated drop)



Lamiera Bugnata Affusolata /
Teardrop patterned steel sheet (tapered drop)

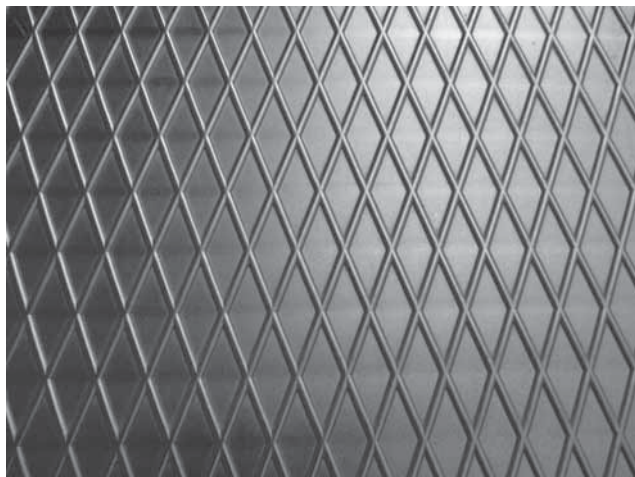
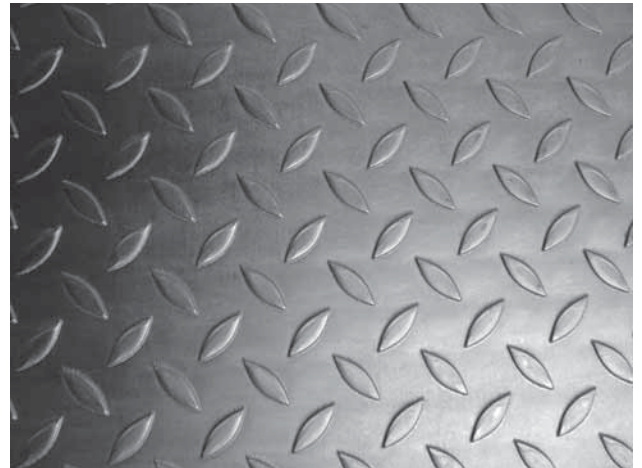

Art. LS1000X2000.30/10.ZF
Lamiera Striata / *Diamond patterned steel sheet*
1000x2000mm sp. 30/10

Art. LS1250X2500.30/10.ZF
Lamiera Striata / *Diamond patterned steel sheet*
1250x2500mm sp. 30/10



sezione ferro	tipo ferro	codice	interasse	nr. fori	tipo fori	luce	trattamento
■ 14x14	liscio / smooth	08.001	140 mm	14 fori / holes	□ 14x14	126 mm	grezzo / raw
■ 16x16	liscio / smooth	08.002	150 mm	13 fori / holes	□ 16x16	134 mm	grezzo / raw
■ 18x18	liscio / smooth	08.003	160 mm	12 fori / holes	□ 18x18	142 mm	grezzo / raw
■ 20x20	liscio / smooth	08.004	170 mm	11 fori / holes	□ 20x20	150 mm	grezzo / raw
■ 22x22	liscio / smooth	08.005	170 mm	11 fori / holes	□ 22x22	148 mm	grezzo / raw
■ 25x25	liscio / smooth	08.006	180 mm	10 fori / holes	□ 25x25	155 mm	grezzo / raw
■ 12x12	liscio / smooth	08.006.01	120 mm	16 fori / holes	□ 12x12	108 mm	grezzo / raw



■ 14x14	liscio / smooth	08.007	140 mm	14 fori / holes	◇ 14x14 sullo spigolo / on the edge	120 mm	grezzo / raw
■ 16x16	liscio / smooth	08.008	150 mm	13 fori / holes	◇ 16x16 sullo spigolo / on the edge	127 mm	grezzo / raw
■ 18x18	liscio / smooth	08.009	160 mm	12 fori / holes	◇ 18x18 sullo spigolo / on the edge	135 mm	grezzo / raw
■ 20x20	liscio / smooth	08.010	170 mm	11 fori / holes	◇ 20x20 sullo spigolo / on the edge	142 mm	grezzo / raw
■ 22x22	liscio / smooth	08.011	170 mm	11 fori / holes	◇ 22x22 sullo spigolo / on the edge	139 mm	grezzo / raw
■ 25x25	liscio / smooth	08.012	180 mm	10 fori / holes	◇ 25x25 sullo spigolo / on the edge	145 mm	grezzo / raw



■ 14x14	liscio / smooth	08.013	140 mm	14 fori / holes	◇ 14x14	120 mm	grezzo / raw
■ 16x16	liscio / smooth	08.014	150 mm	13 fori / holes	◇ 16x16	127 mm	grezzo / raw
■ 18x18	liscio / smooth	08.015	160 mm	12 fori / holes	◇ 18x18	135 mm	grezzo / raw
■ 20x20	liscio / smooth	08.016	170 mm	11 fori / holes	◇ 20x20	142 mm	grezzo / raw
■ 22x22	liscio / smooth	08.017	170 mm	11 fori / holes	◇ 22x22	139 mm	grezzo / raw
■ 25x25	liscio / smooth	08.018	180 mm	10 fori / holes	◇ 25x25	145 mm	grezzo / raw



Ø 14	liscio / smooth	08.019	140 mm	14 fori / holes	Ø 14 ovale / oval		grezzo / raw
Ø 16	liscio / smooth	08.020	150 mm	13 fori / holes	Ø 16 ovale / oval		grezzo / raw
Ø 18	liscio / smooth	08.021	160 mm	12 fori / holes	Ø 18 ovale / oval		grezzo / raw
Ø 20	liscio / smooth	08.022	170 mm	11 fori / holes	Ø 20 ovale / oval		grezzo / raw



Ø 14	liscio / smooth	08.023	140 mm	14 fori / holes	Ø 14	126 mm	grezzo / raw
Ø 16	liscio / smooth	08.024	150 mm	13 fori / holes	Ø 16	126 mm	grezzo / raw
Ø 18	liscio / smooth	08.025	160 mm	12 fori / holes	Ø 18	142 mm	grezzo / raw
Ø 20	liscio / smooth	08.026	170 mm	11 fori / holes	Ø 20	150 mm	grezzo / raw
Ø 22	liscio / smooth	08.027	170 mm	11 fori / holes	Ø 22	148 mm	grezzo / raw
Ø 25	liscio / smooth	08.028	180 mm	10 fori / holes	Ø 25	155 mm	grezzo / raw
Ø 30	liscio / smooth	08.029	200 mm	9 fori / holes	Ø 30	170 mm	grezzo / raw
Ø 12	liscio / smooth	08.029.01	120 mm	16 fori / holes	Ø 12	108 mm	grezzo / raw



■ 14x14	liscio / smooth	08.106	140 mm	14 fori / holes	□ 24x15 rettangolo / rectangular		grezzo / raw
■ 16x16	liscio / smooth	08.107	150 mm	13 fori / holes	□ 30x17 rettangolo / rectangular		grezzo / raw
■ 18x18	liscio / smooth	08.108	160 mm	12 fori / holes	□ 31x19 rettangolo / rectangular		grezzo / raw
■ 20x20	liscio / smooth	08.109	170 mm	11 fori / holes	□ 33x21 rettangolo / rectangular		grezzo / raw



sezione ferro	tipo ferro	codice	interasse	nr. fori	tipo fori	luce	trattamento
Ø 14	corteccia / bark	08.109.01	140 mm	14 fori / holes	Ø 14	126 mm	grezzo / raw
Ø 16	corteccia / bark	08.109.02	150 mm	13 fori / holes	Ø 16	126 mm	grezzo / raw
Ø 18	corteccia / bark	08.109.03	160 mm	12 fori / holes	Ø 18	142 mm	grezzo / raw
Ø 20	corteccia / bark	08.109.04	170 mm	11 fori / holes	Ø 20	150 mm	grezzo / raw
Ø 22	corteccia / bark	08.109.05	170 mm	11 fori / holes	Ø 22	148 mm	grezzo / raw



■ 12x12	martellato / hammered	08.110	120 mm	16 fori / holes	□ 12x12	108 mm	grezzo / raw
■ 14x14	martellato / hammered	08.111	140 mm	14 fori / holes	□ 14x14	126 mm	grezzo / raw
■ 16x16	martellato / hammered	08.112	150 mm	13 fori / holes	□ 16x16	134 mm	grezzo / raw
■ 18x18	martellato / hammered	08.113	160 mm	12 fori / holes	□ 18x18	142 mm	grezzo / raw
■ 20x20	martellato / hammered	08.114	170 mm	11 fori / holes	□ 20x20	150 mm	grezzo / raw



■ 14x14	corteccia / bark	08.114.01	140 mm	14 fori / holes	□ 14x14	126 mm	grezzo / raw
■ 16x16	corteccia / bark	08.114.02	150 mm	13 fori / holes	□ 16x16	134 mm	grezzo / raw



■ 14x14	corteccia / bark	08.114.10	140 mm	14 fori / holes	◇ 14x14	120 mm	grezzo / raw
■ 16x16	corteccia / bark	08.114.11	150 mm	13 fori / holes	◇ 16x16	127 mm	grezzo / raw



■ 14x14	martellato / hammered	08.114.20	140 mm	14 fori / holes	◇ 14x14 sullo spigolo / on the edge	120 mm	grezzo / raw
■ 16x16	martellato / hammered	08.114.21	150 mm	13 fori / holes	◇ 16x16 sullo spigolo / on the edge	127 mm	grezzo / raw



■ 12x12	in spigolo / edged	08.114.30	120 mm	16 fori / holes	□ 12x12	108 mm	grezzo / raw
■ 14x14	in spigolo / edged	08.114.31	140 mm	14 fori / holes	□ 14x14	126 mm	grezzo / raw
■ 16x16	in spigolo / edged	08.114.32	150 mm	13 fori / holes	□ 16x16	134 mm	grezzo / raw
■ 18x18	in spigolo / edged	08.114.33	160 mm	12 fori / holes	□ 18x18	142 mm	grezzo / raw



Ø 14	liscio / smooth	08.115	125 mm	15 fori / holes	Ø 14	111 mm	grezzo / raw
Ø 14	liscio / smooth	08.115.01	130 mm	14 fori / holes	Ø 14	116 mm	grezzo / raw
Ø 16	liscio / smooth	08.116	125 mm	15 fori / holes	Ø 16	109 mm	grezzo / raw
Ø 16	liscio / smooth	08.116.01	160 mm	12 fori / holes	Ø 16	144 mm	grezzo / raw
Ø 18	liscio / smooth	08.117	128 mm	14 fori / holes	Ø 18	110 mm	grezzo / raw
Ø 20	liscio / smooth	08.118	130 mm	13 fori / holes	Ø 20	110 mm	grezzo / raw



■ 14x14	liscio / smooth	08.119	125 mm	15 fori / holes	□ 14x14	111 mm	grezzo / raw
■ 14x14	liscio / smooth	08.119.01	125 mm	14 fori / holes	□ 14x14	121 mm.	grezzo / raw
■ 16x16	liscio / smooth	08.120	125 mm	15 fori / holes	□ 16x16	109 mm	grezzo / raw
■ 16x16	liscio / smooth	08.120.01	135 mm	14 fori / holes	□ 16x16	119 mm	grezzo / raw
■ 18x18	liscio / smooth	08.121	128 mm	14 fori / holes	□ 18x18	110 mm	grezzo / raw
■ 20x20	liscio / smooth	08.122	130 mm	13 fori / holes	□ 20x20	110 mm	grezzo / raw



sezione ferro	tipo ferro	codice	interasse	nr. fori	tipo fori	luce	trattamento
■ 14x14	liscio / smooth	08.123	128 mm	14 fori / holes	◇14x14 sullo spigolo / on the edge	108 mm	grezzo / raw
■ 16x16	liscio / smooth	08.124	130 mm	14 fori / holes	◇16x16 sullo spigolo / on the edge	107 mm	grezzo / raw
■ 18x18	liscio / smooth	08.125	132 mm	14 fori / holes	◇18x18 sullo spigolo / on the edge	107 mm	grezzo / raw
■ 20x20	liscio / smooth	08.126	134 mm	13 fori / holes	◇20x20 sullo spigolo / on the edge	106 mm	grezzo / raw



■ 14x14	liscio / smooth	08.127	128 mm	14 fori / holes	◇14x14	108 mm	grezzo / raw
■ 14x14	liscio / smooth	08.127.01	135 mm	14 fori / holes	◇14x14	115 mm	grezzo / raw
■ 16x16	liscio / smooth	08.128	130 mm	14 fori / holes	◇16x16	107 mm	grezzo / raw
■ 16x16	liscio / smooth	08.128.01	135 mm	14 fori / holes	◇16x16	112 mm	grezzo / raw
■ 16x16	liscio / smooth	08.128.02	125 mm	15 fori / holes	◇16x16	102 mm	grezzo / raw
■ 18x18	liscio / smooth	08.129	132 mm	14 fori / holes	◇18x18	107 mm	grezzo / raw
■ 18x18	liscio / smooth	08.129.01	135 mm	14 fori / holes	◇18x18	110 mm	grezzo / raw
■ 20x20	liscio / smooth	08.130	135 mm	13 fori / holes	◇20x20	107 mm	grezzo / raw



Ø 14	corteccia / bark	08.130.01	125 mm	15 fori / holes	Ø 14	111 mm	grezzo / raw
Ø 16	corteccia / bark	08.130.02	125 mm	15 fori / holes	Ø 16	109 mm	grezzo / raw
Ø 18	corteccia / bark	08.130.03	128 mm	14 fori / holes	Ø 18	110 mm	grezzo / raw



■ 16x16	liscio / smooth	08.131	125 mm	15 fori / holes	□ 14x14	111 mm	grezzo / raw
---------	-----------------	---------------	--------	-----------------	---------	--------	--------------



Ø 16	liscio / smooth	08.132	125 mm	15 fori / holes	Ø 14	111 mm	grezzo / raw
------	-----------------	---------------	--------	-----------------	------	--------	--------------

SABBIATE / SAND - BLASTED



■ 12x12	liscio / smooth	08.133	120 mm	16 fori / holes	□ 12x12	108 mm	sabbiato / sandblasted
■ 14x14	liscio / smooth	08.134	140 mm	14 fori / holes	□ 14x14	126 mm	sabbiato / sandblasted
■ 16x16	liscio / smooth	08.135	150 mm	13 fori / holes	□ 16x16	134 mm	sabbiato / sandblasted
■ 18x18	liscio / smooth	08.136	160 mm	12 fori / holes	□ 18x18	142 mm	sabbiato / sandblasted
■ 20x20	liscio / smooth	08.137	170 mm	11 fori / holes	□ 20x20	150 mm	sabbiato / sandblasted
■ 22x22	liscio / smooth	08.138	170 mm	11 fori / holes	□ 22x22	148 mm	sabbiato / sandblasted
■ 25x25	liscio / smooth	08.139	180 mm	10 fori / holes	□ 25x25	155 mm	sabbiato / sandblasted

SABBIATE / SAND - BLASTED



■ 14x14	liscio / smooth	08.140	140 mm	14 fori / holes	◇ 14x14 sullo spigolo / on the edge	120 mm	sabbiato / sandblasted
■ 16x16	liscio / smooth	08.141	150 mm	13 fori / holes	◇ 16x16 sullo spigolo / on the edge	127 mm	sabbiato / sandblasted
■ 18x18	liscio / smooth	08.142	160 mm	12 fori / holes	◇ 18x18 sullo spigolo / on the edge	135 mm	sabbiato / sandblasted
■ 20x20	liscio / smooth	08.143	170 mm	11 fori / holes	◇ 20x20 sullo spigolo / on the edge	142 mm	sabbiato / sandblasted
■ 22x22	liscio / smooth	08.144	170 mm	11 fori / holes	◇ 22x22 sullo spigolo / on the edge	139 mm	sabbiato / sandblasted
■ 25x25	liscio / smooth	08.145	180 mm	10 fori / holes	◇ 25x25 sullo spigolo / on the edge	145 mm	sabbiato / sandblasted

SABBIATE / SAND - BLASTED



sezione ferro	tipo ferro	codice	interasse	nr. fori	tipo fori	luce	trattamento
■ 14x14	liscio / smooth	08.146	140 mm	14 fori / holes	◇ 14x14	120 mm	sabbiato / sandblasted
■ 16x16	liscio / smooth	08.147	150 mm	13 fori / holes	◇ 16x16	127 mm	sabbiato / sandblasted
■ 18x18	liscio / smooth	08.148	160 mm	12 fori / holes	◇ 18x18	135 mm	sabbiato / sandblasted
■ 20x20	liscio / smooth	08.149	170 mm	11 fori / holes	◇ 20x20	142 mm	sabbiato / sandblasted
■ 22x22	liscio / smooth	08.150	170 mm	11 fori / holes	◇ 22x22	139 mm	sabbiato / sandblasted
■ 25x25	liscio / smooth	08.151	180 mm	10 fori / holes	◇ 25x25	145 mm	sabbiato / sandblasted

SABBIATE / SAND - BLASTED



Ø 14	liscio / smooth	08.152	140 mm	14 fori / holes	Ø 14 ovale / oval		sabbiato / sandblasted
Ø 16	liscio / smooth	08.153	150 mm	13 fori / holes	Ø 16 ovale / oval		sabbiato / sandblasted
Ø 18	liscio / smooth	08.154	160 mm	12 fori / holes	Ø 18 ovale / oval		sabbiato / sandblasted
Ø 20	liscio / smooth	08.155	170 mm	11 fori / holes	Ø 20 ovale / oval		sabbiato / sandblasted

BARRE FORATE SABBIASTE HOLED BARS SAND - BLASTED

SABBIASTE / SAND - BLASTED



Ø 12	liscio / smooth	08.156	120 mm	16 fori / holes	Ø 12	108 mm	sabbiato / sandblasted
Ø 14	liscio / smooth	08.157	140 mm	14 fori / holes	Ø 14	126 mm	sabbiato / sandblasted
Ø 16	liscio / smooth	08.158	150 mm	13 fori / holes	Ø 16	126 mm	sabbiato / sandblasted
Ø 18	liscio / smooth	08.159	160 mm	12 fori / holes	Ø 18	142 mm	sabbiato / sandblasted
Ø 20	liscio / smooth	08.160	170 mm	11 fori / holes	Ø 20	150 mm	sabbiato / sandblasted
Ø 22	liscio / smooth	08.161	170 mm	11 fori / holes	Ø 22	148 mm	sabbiato / sandblasted
Ø 25	liscio / smooth	08.162	180 mm	10 fori / holes	Ø 25	155 mm	sabbiato / sandblasted
Ø 30	liscio / smooth	08.163	200 mm	9 fori / holes	Ø 30	170 mm	sabbiato / sandblasted
Ø 14	liscio / smooth	08.164	125 mm	15 fori / holes	Ø 14	111 mm	sabbiato / sandblasted
Ø 14	liscio / smooth	08.164.01	130 mm	14 fori / holes	Ø 14	116 mm	sabbiato / sandblasted
Ø 16	liscio / smooth	08.165	125 mm	15 fori / holes	Ø 16	109 mm	sabbiato / sandblasted
Ø 16	liscio / smooth	08.165.01	160 mm	12 fori / holes	Ø 16	144 mm	sabbiato / sandblasted
Ø 18	liscio / smooth	08.166	128 mm	14 fori / holes	Ø 18	110 mm	sabbiato / sandblasted
Ø 20	liscio / smooth	08.167	130 mm	13 fori / holes	Ø 20	110 mm	sabbiato / sandblasted

SABBIASTE / SAND - BLASTED



■ 14x14	liscio / smooth	08.168	125 mm	15 fori / holes	□ 14x14	111 mm	sabbiato / sandblasted
■ 14x14	liscio / smooth	08.168.01	125 mm	14 fori / holes	□ 14x14	121 mm.	sabbiato / sandblasted
■ 16x16	liscio / smooth	08.169	125 mm	15 fori / holes	□ 16x16	109 mm	sabbiato / sandblasted
■ 16x16	liscio / smooth	08.169.01	135 mm	14 fori / holes	□ 16x16	119 mm	sabbiato / sandblasted
■ 18x18	liscio / smooth	08.170	128 mm	14 fori / holes	□ 18x18	110 mm	sabbiato / sandblasted
■ 20x20	liscio / smooth	08.171	130 mm	13 fori / holes	□ 20x20	110 mm	sabbiato / sandblasted

SABBIASTE / SAND - BLASTED



sezione ferro	tipo ferro	codice	interasse	nr. fori	tipo fori	luce	trattamento
■ 14x14	liscio / smooth	08.172	128 mm	14 fori / holes	◇14x14 sullo spigolo / on the edge	108 mm	sabbiato / sandblasted
■ 16x16	liscio / smooth	08.173	130 mm	14 fori / holes	◇16x16 sullo spigolo / on the edge	107 mm	sabbiato / sandblasted
■ 18x18	liscio / smooth	08.174	132 mm	14 fori / holes	◇18x18 sullo spigolo / on the edge	107 mm	sabbiato / sandblasted
■ 20x20	liscio / smooth	08.175	134 mm	13 fori / holes	◇20x20 sullo spigolo / on the edge	106 mm	sabbiato / sandblasted

SABBIASTE / SAND - BLASTED



■ 14x14	liscio / smooth	08.176	128 mm	14 fori / holes	◇14x14	108 mm	sabbiato / sandblasted
■ 14x14	liscio / smooth	08.176.01	135 mm	14 fori / holes	◇14x14	115 mm	sabbiato / sandblasted
■ 16x16	liscio / smooth	08.177	130 mm	14 fori / holes	◇16x16	107 mm	sabbiato / sandblasted
■ 16x16	liscio / smooth	08.177.01	135 mm	14 fori / holes	◇16x16	112 mm	sabbiato / sandblasted
■ 16x16	liscio / smooth	08.177.02	125 mm	15 fori / holes	◇16x16	102 mm	sabbiato / sandblasted
■ 18x18	liscio / smooth	08.178	132 mm	14 fori / holes	◇18x18	107 mm	sabbiato / sandblasted
■ 18x18	liscio / smooth	08.178.01	135 mm	14 fori / holes	◇18x18	110 mm	sabbiato / sandblasted
■ 20x20	liscio / smooth	08.179	135 mm	13 fori / holes	◇20x20	107 mm	sabbiato / sandblasted

SABBIATE / SAND - BLASTED



■ 16x16	liscio / smooth	08.180	125 mm	15 fori / holes	□ 14x14	111 mm	sabbiato / sandblasted
---------	-----------------	---------------	--------	-----------------	---------	--------	------------------------

SABBIATE / SAND - BLASTED



Ø 16	liscio / smooth	08.181	125 mm	15 fori / holes	Ø 14	111 mm	sabbiato / sandblasted
------	-----------------	---------------	--------	-----------------	------	--------	------------------------

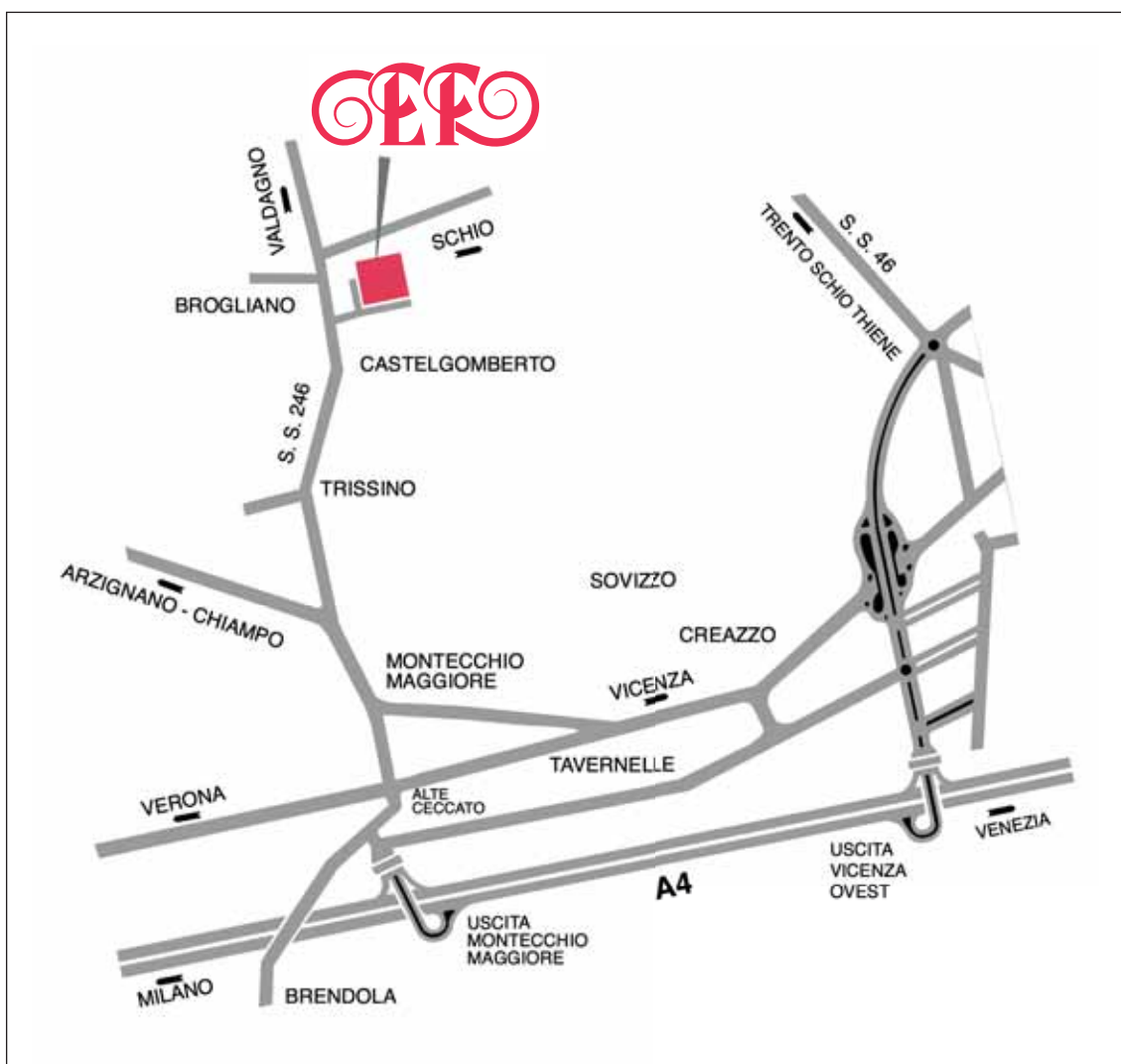

EURO-FER S.p.A.

Viale dell'Industria 16/18
Castelgomberto (Vicenza)

Telefono: +39 0445 440033

FAX: +39 0445 440351

E-mail: eurofer@eurofer.com

www.eurofer.com

EUROFER®

LAVORAZIONE DEL FERRO BATTUTO & ACCIAIO INOX
WROUGHT IRON & STAINLESS STEEL WORKING

MADE IN STEEL | MILANO 2019

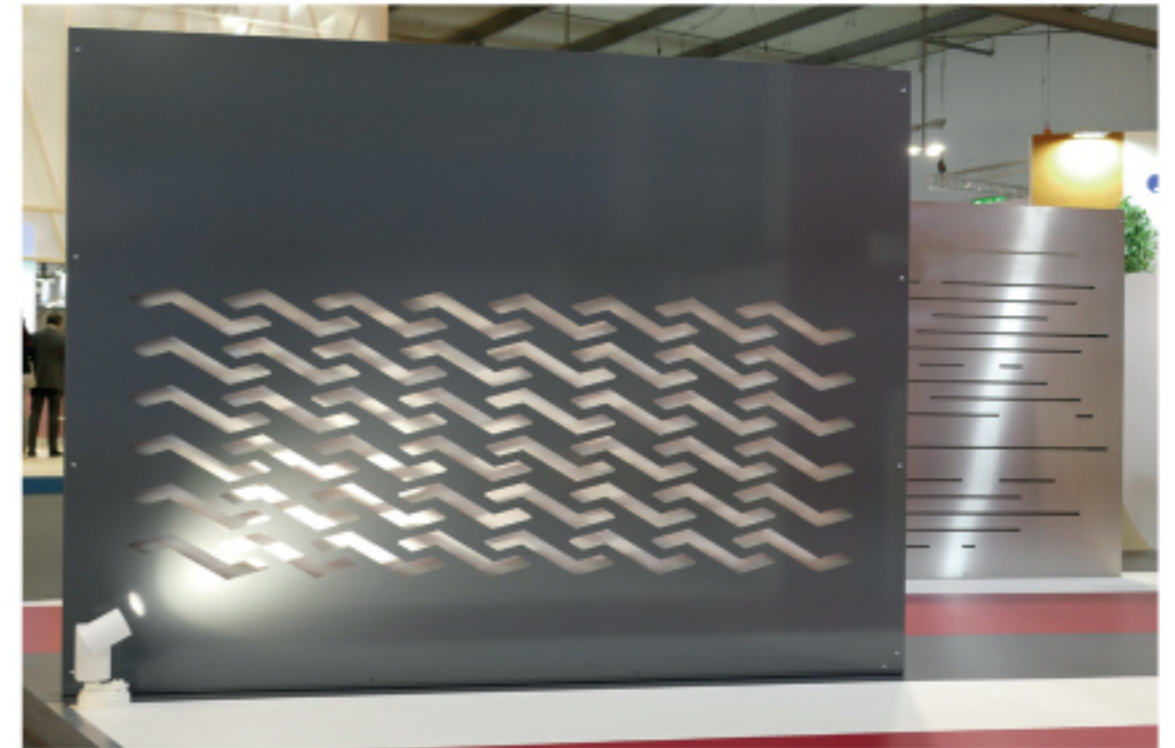
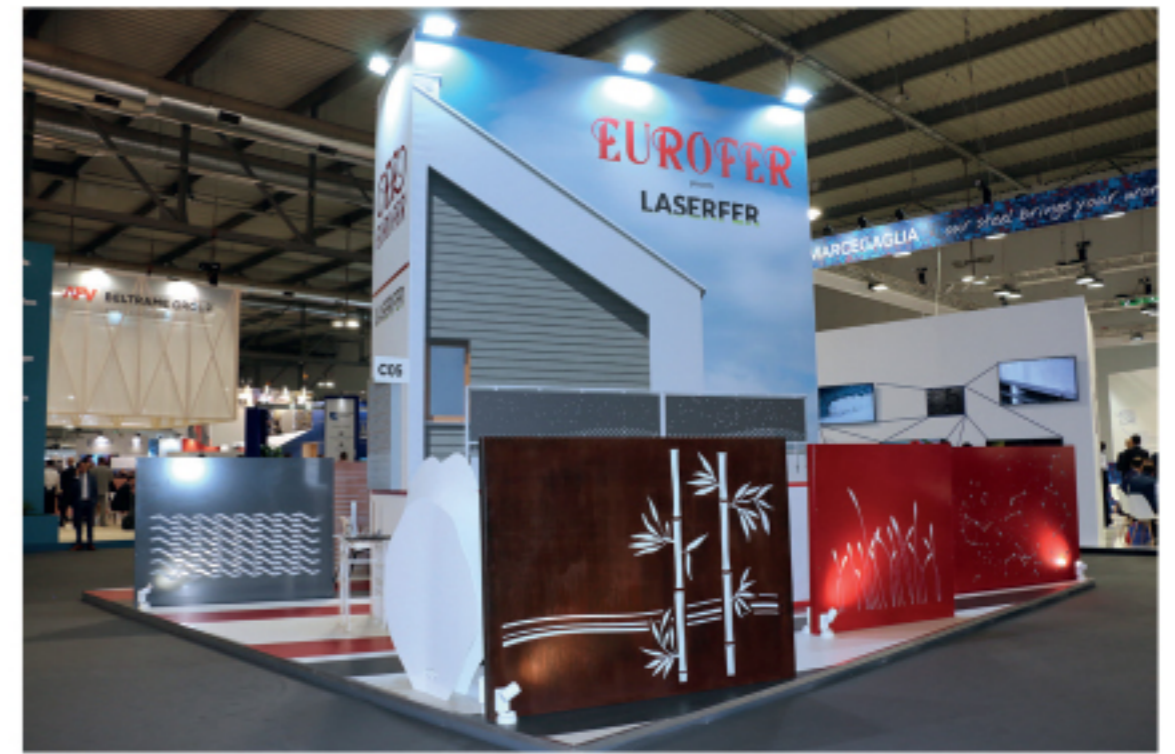
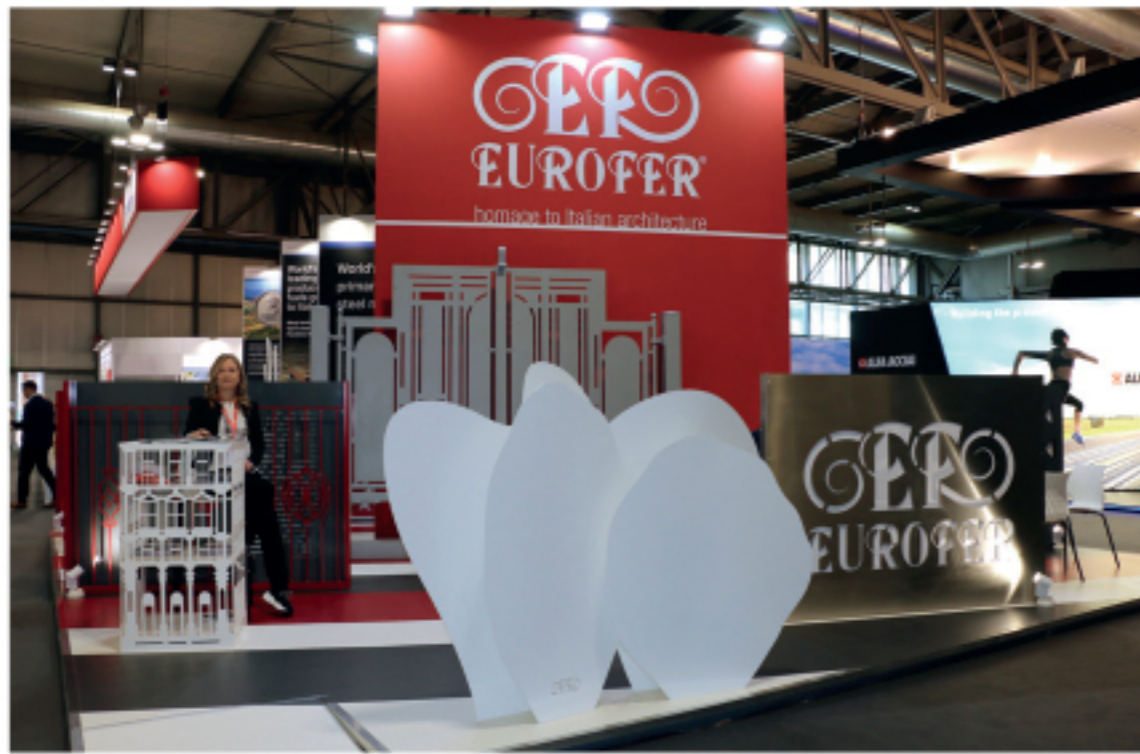

MADE EXPO | MILANO 2019

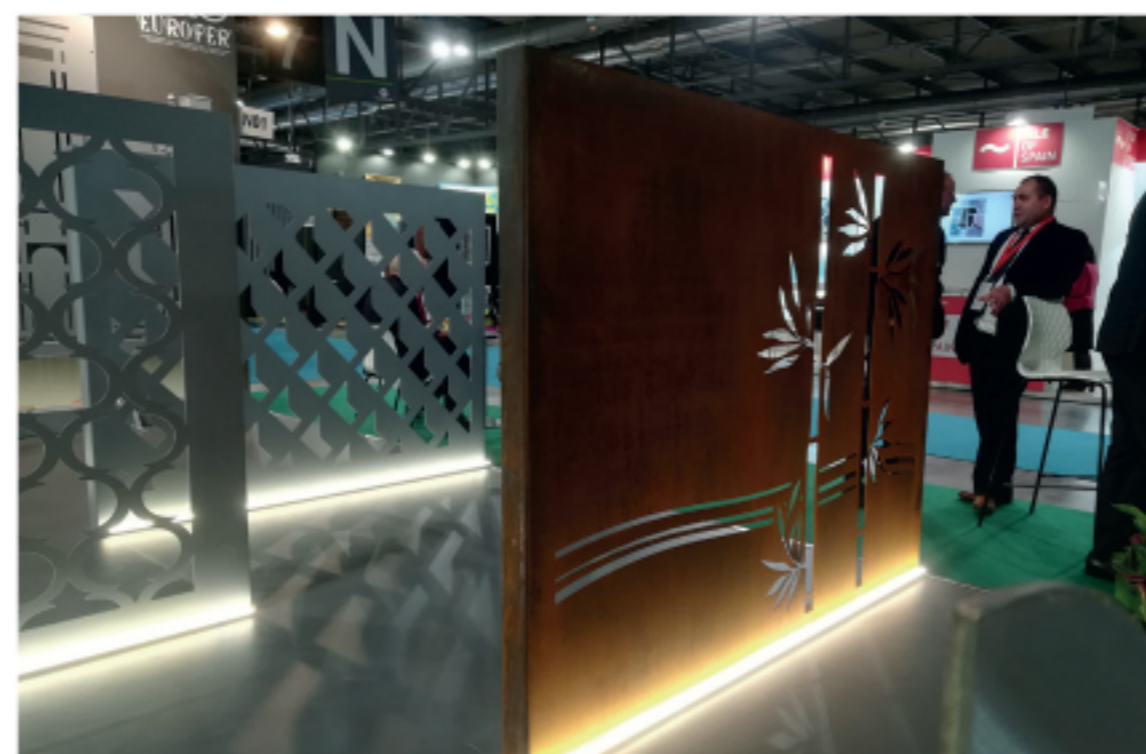

DESIGN SHANGHAI | 2019



MILANO DESIGN WEEK 2019



Dati, foto e caratteristiche non sono impegnativi; Euro-Fer si riserva di apportare le modifiche che riterrà opportune per migliorare i suoi prodotti. Tutte le parti di questo catalogo - foto comprese - sono di proprietà Euro-Fer. La riproduzione, anche parziale, è vietata in ogni forma e con ogni mezzo.

Data, photos, and characteristics are not binding; Euro-Fer reserves the right to produce modifications considered necessary to improve its products. Every part of this catalogue - photos included - is Euro-Fer's property. All forms of copying are strictly prohibited.

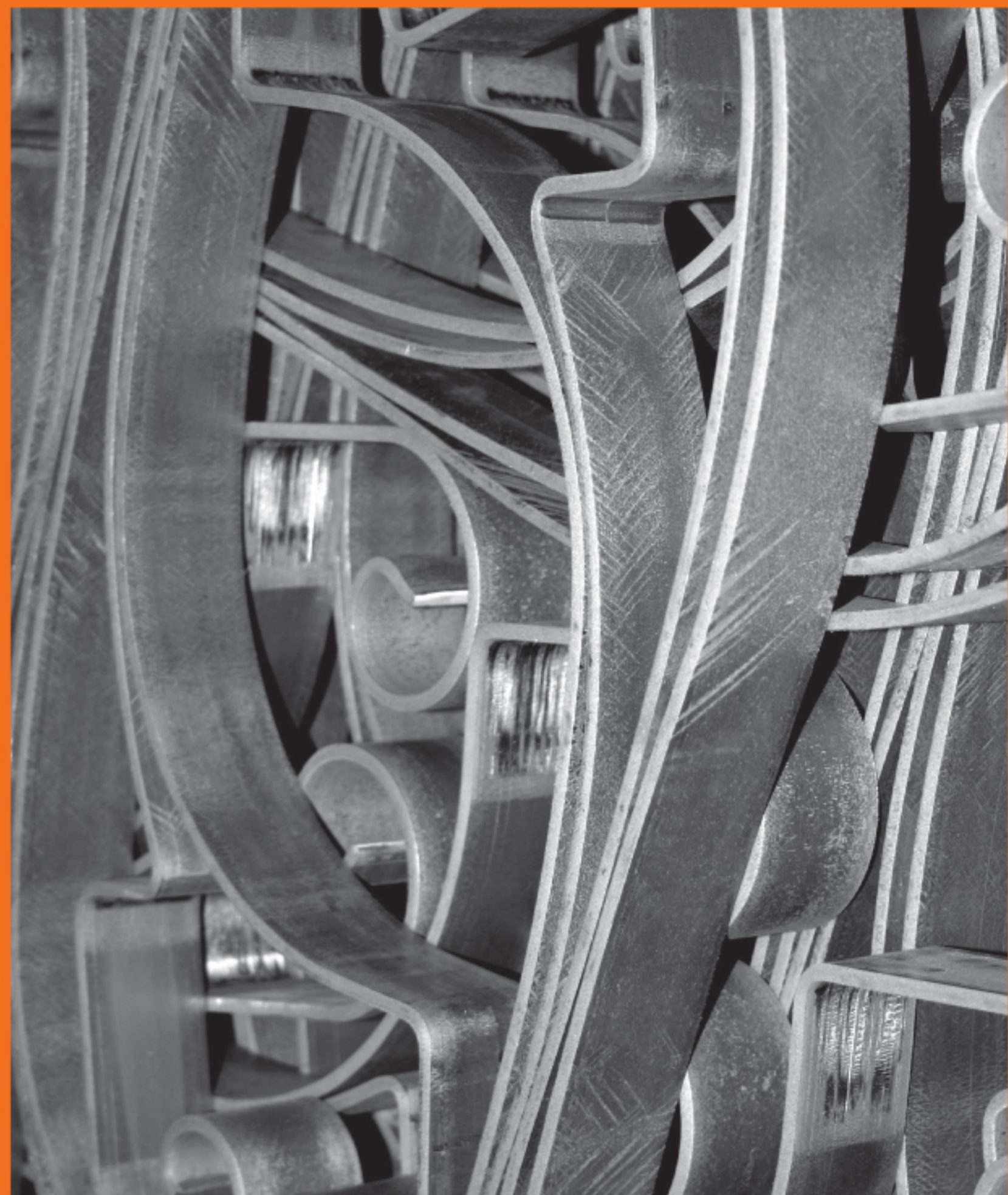

EURO-FER S.p.A.

Viale dell'Industria 16/18
Castelgomberto (Vicenza)
Telefono: +39 0445 440033
FAX: +39 0445 440351
E-mail: eurofer@eurofer.com



www.eurofer.com

