

**PARETE  
SOFFITTO**

**23**

**LIGHTBOOK**

# **PROFILI VELETTE**

# Sotto Pensile

Profilo per sotto pensili super slim cablati su misura. Il cavo di alimentazione può uscire dal tappo, sulla schiena o su di un lato. Perfetto con il suo interruttore TOUCH-DIMM.

- **Materiale: Alluminio**
- **Potenza max applicabile: 15W/m**
- **Lunghezza barra: 3 metri**
- **Fornito con diffusore opale**

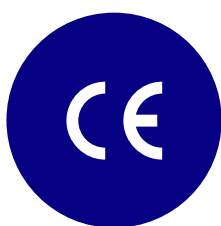

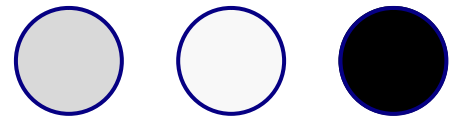
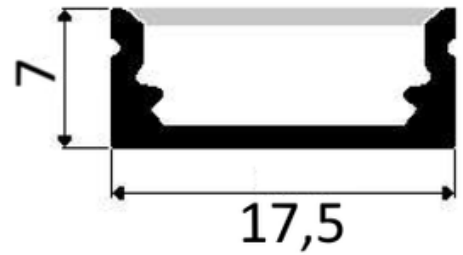

<b>CODICE</b>	<b>NOME</b>
SB074	Bianco
SB075	Nero
SB076	Alluminio
SB077	Kit tappi
SB078	Touch DIM



# Profilo Soffitto

Profilo perfetto per montaggio a soffitto. Liscio ai lati e con clip a scomparsa. Ideale per curve a 90° con i suoi accessori. Ottimo per illuminazione generale grandi ambienti.

- **Materiale: Alluminio**
- **Potenza max applicabile: 26W/m**
- **Lunghezza barra: 2 metri**
- **Fornito con diffusore opale**

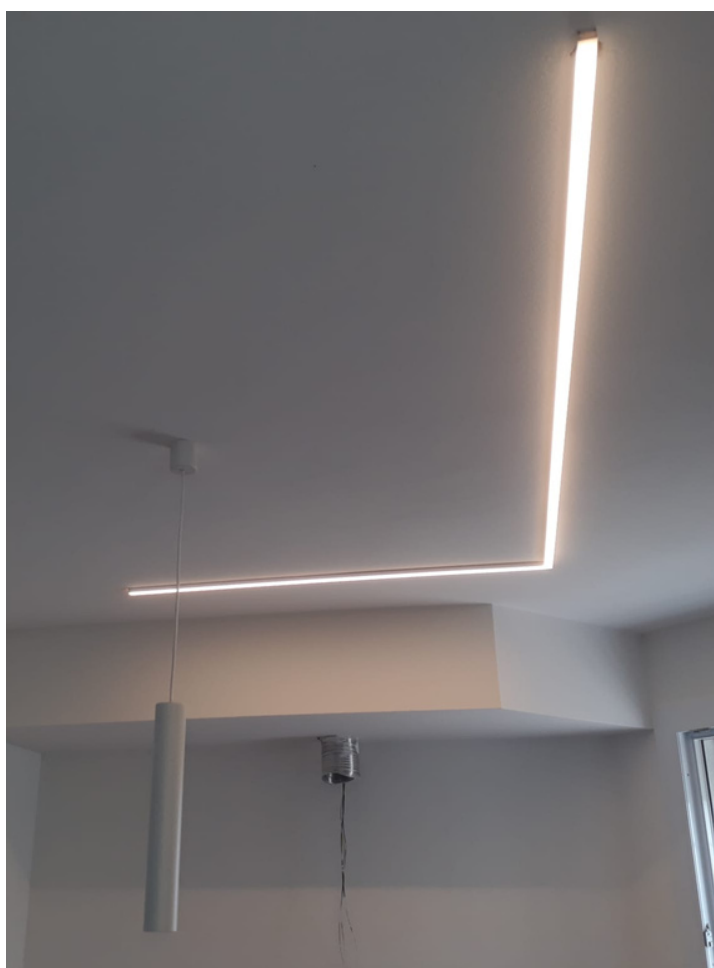
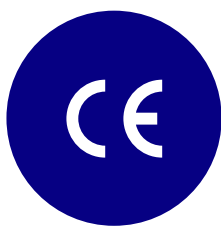

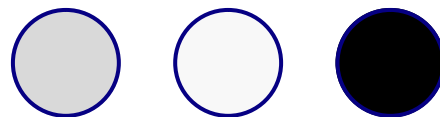
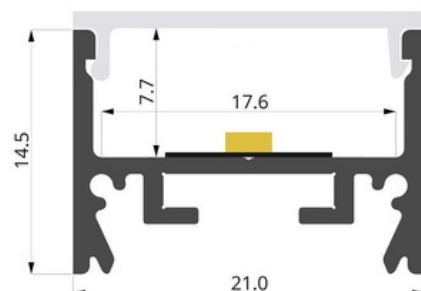

<b>CODICE</b>	<b>NOME</b>
SB079	Bianco
SB080	Nero
SB081	Alluminio
SB082	Kit tappi
SB083	Giunto



# Profilo Flex

Profilo flessibile manualmente, ideale per illuminare superfici curve, archi, cartongessi.

Consigliato utilizzare con strip LED per non creare "effetto puntinato".

- **Materiale: Alluminio**
- **Potenza max applicabile: 20W/m**
- **Lunghezza barra: 2 metri**
- **Fornito con diffusore opale**



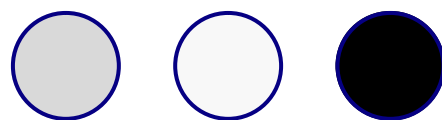
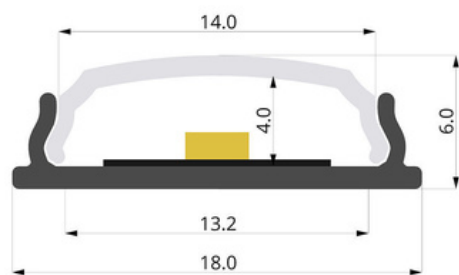

<b>CODICE</b>	<b>NOME</b>
SB083	Bianco
SB084	Alluminio
SB085	Kit tappi



# Space 9

Profilo angolare con grandi capacità di dissipazione. Perfetto per illuminare in modo indiretto i soffitti. Da utilizzare anche nascosto tra i travi per valorizzare pareti sottostanti.

- **Materiale: Alluminio**
- **Potenza max applicabile: 26W/m**
- **Lunghezza barra: 3 metri**
- **Fornito con diffusore opale**

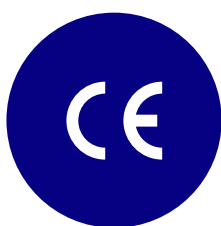



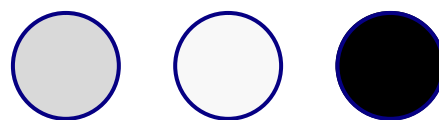
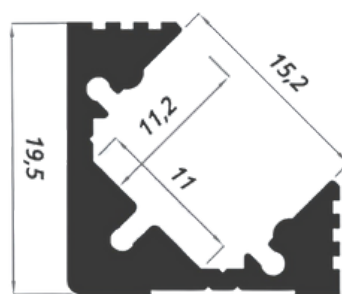
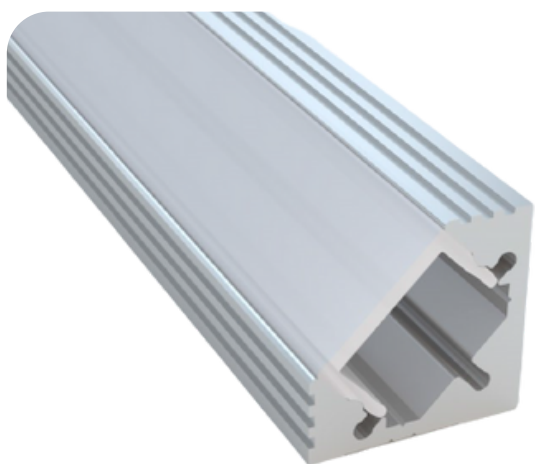

<b>CODICE</b>	<b>NOME</b>
SB086	Bianco
SB087	Nero
SB088	Alluminio
SB089	Kit tappi



# Veletta 220

Veletta Biemissione con vano porta alimentatore. Componibile in linea continua. Possibilità di inserire centralina dimmer. Ideale per illuminare stanze e pareti o creare configurazioni di grandi lunghezze.

- **Materiale: Alluminio**
- **Potenza max applicabile: 26W/m**
- **Lunghezza barra: 2 metri**
- **Fornito con diffusore opale**

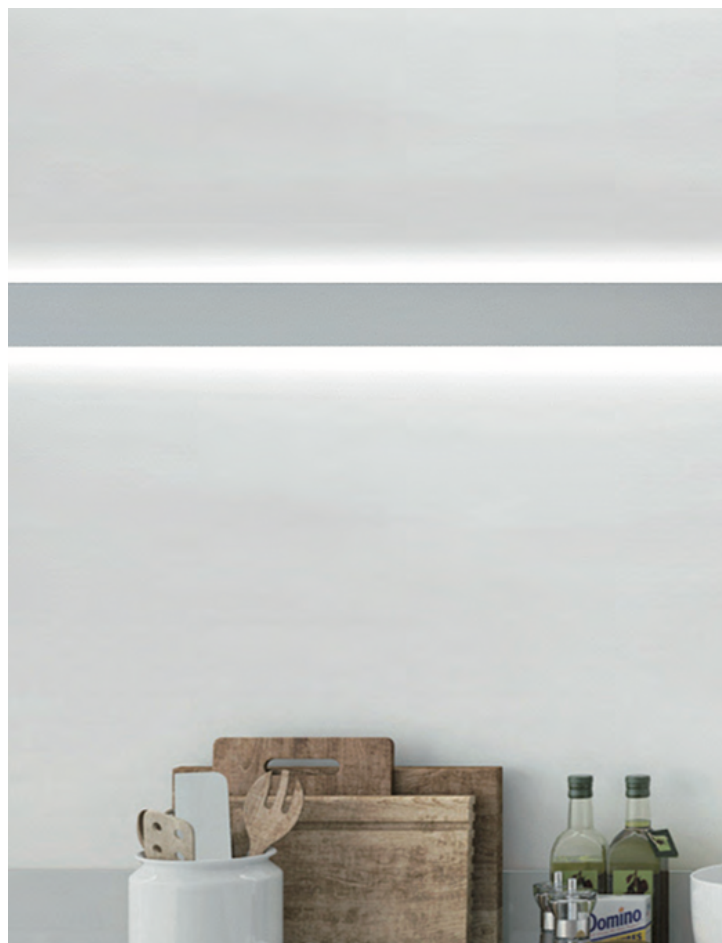
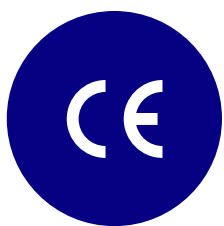

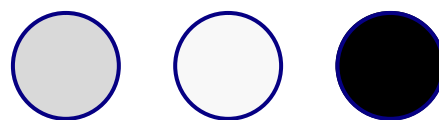
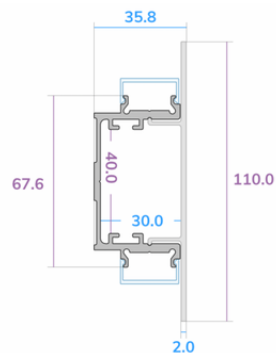
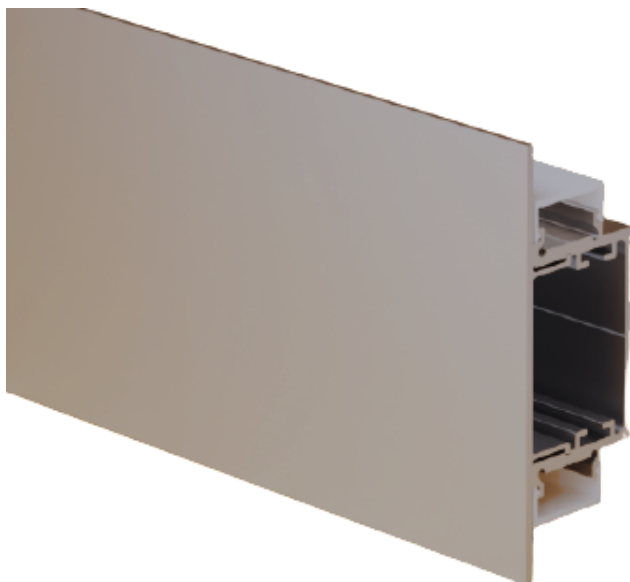

<b>CODICE</b>	<b>NOME</b>
SB087	Bianco
SB088	Nero
SB089	Alluminio
SB090	Kit tappi



# Veletta slim

Veletta biemissione Slim, sottilissima. Ideale per illuminare in modo diffuso stanze e pareti. Perfetta per creare file continue luminose minimali. Consigliato inserimento su pareti divano, corridoi, pareti letto.

- **Materiale: Alluminio**
- **Potenza max applicabile: 26W/m**
- **Lunghezza barra: 2 metri**
- **Fornito con diffusore opale**

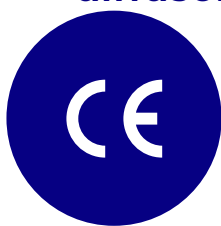

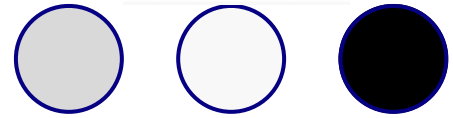
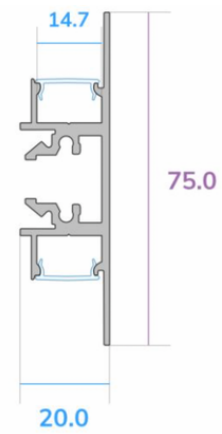
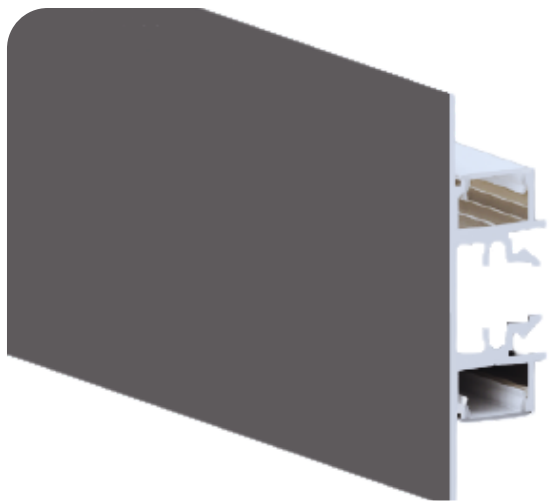

<b>CODICE</b>	<b>NOME</b>
SB091	Bianco
SB092	Nero
SB093	Alluminio
SB094	Kit tappi



# Gola Luminosa Slim

Profilo per Gola luminosa con montaggio in superficie, tra parete e soffitto. Ideale per illuminare in modo diffuso le pareti. Possibilità di creare file continue o di montarla anche come veletta a luce verso l'alto.

- **Materiale: Alluminio**
- **Potenza max applicabile: 26W/m**
- **Lunghezza barra: 3 metri**
- **Fornito con diffusore opale**

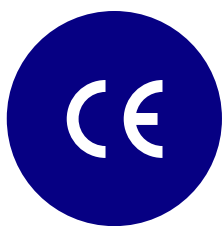

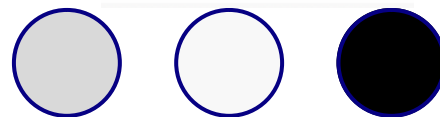
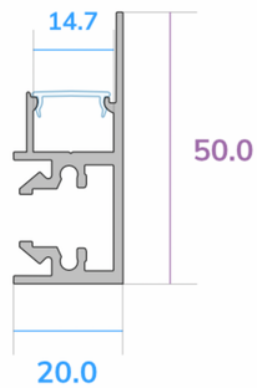
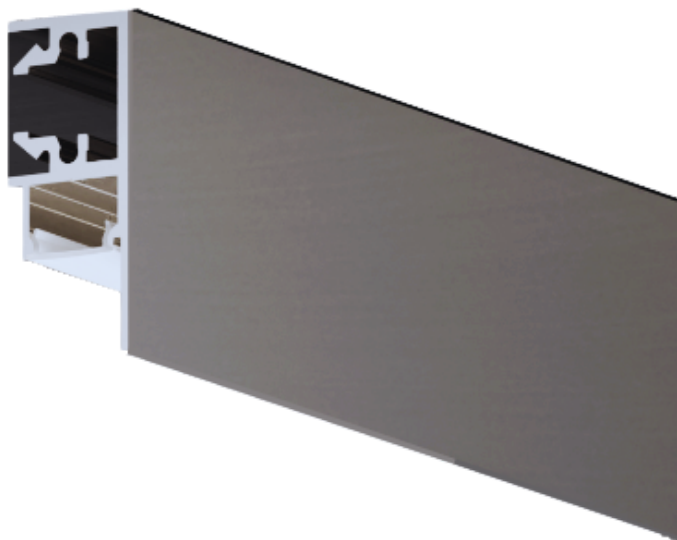

<b>CODICE</b>	<b>NOME</b>
SB095	Bianco
SB096	Nero
SB097	Alluminio
SB098	Kit tappi



# Veletta Soft

Profilo per veletta monoemissione. Luce verso l'alto. Forma morbida e particolare, ideale per creare effetti di illuminazione indiretta generale.

- **Materiale: Alluminio**
- **Potenza max applicabile: 15W/m**
- **Lunghezza barra: 2 metri**
- **Fornito con diffusore opale**

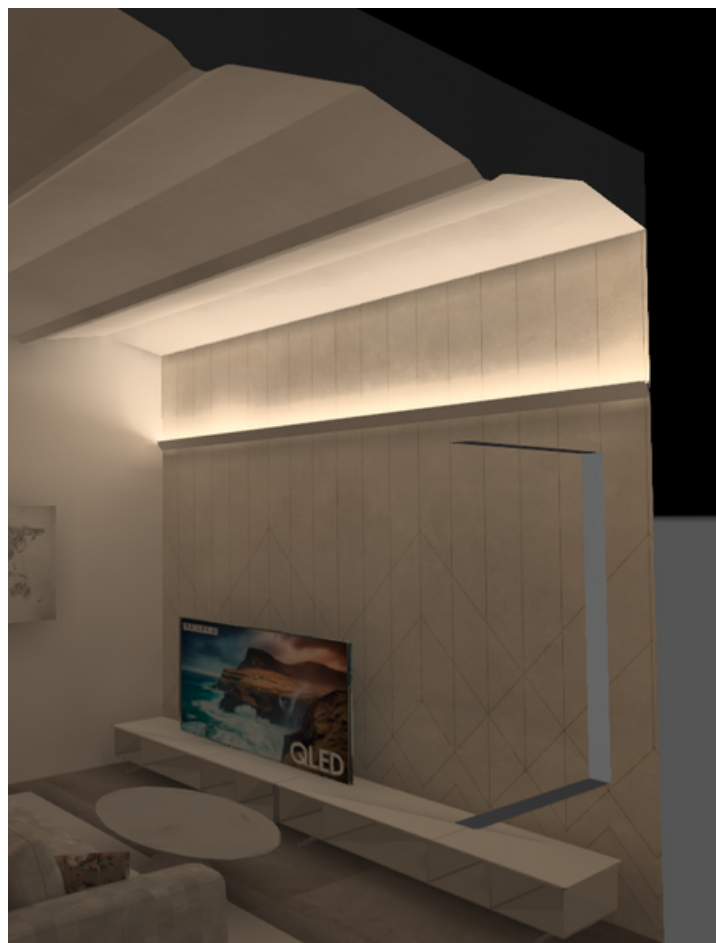
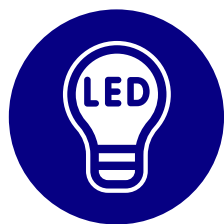
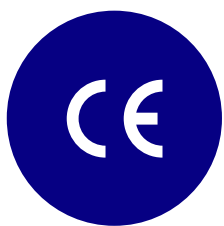



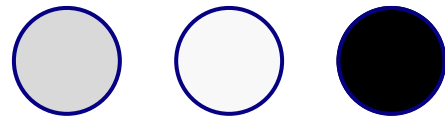
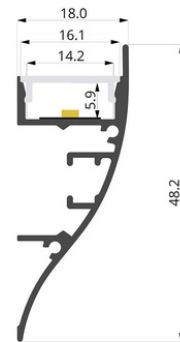

<b>CODICE</b>	<b>NOME</b>
SB099	Bianco
SB100	Nero
SB101	Alluminio
SB102	Kit tappi



# Veletta Klein

Profilo per veletta monoemissione. Luce verso l'alto. Forma minimale e piccolissima ideale per creare effetti di illuminazione indiretta generale. Montaggio anche in verticale

- **Materiale: Alluminio**
- **Potenza max applicabile: 20W/m**
- **Lunghezza barra: 2 metri**
- **Fornito con diffusore opale**

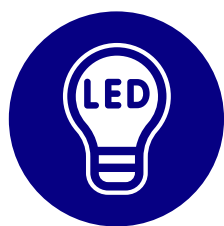
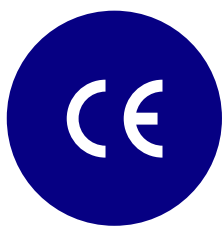

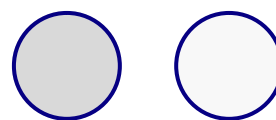
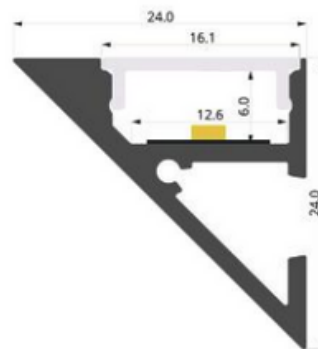

<b>CODICE</b>	<b>NOME</b>
SB382	Bianco
SB383	Alu
SB384	Tappi Bianco
SB385	Tappi Alu

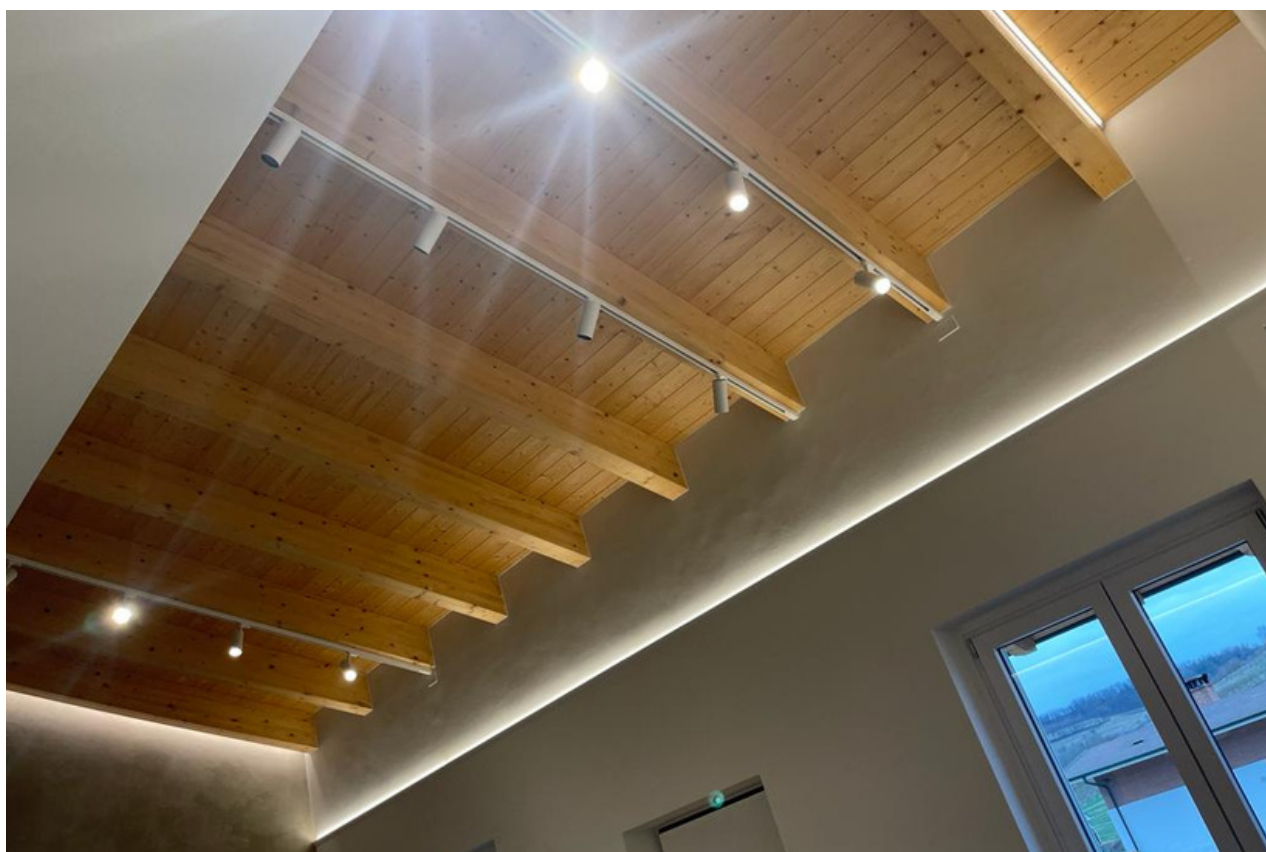

# Veletta Angolare

La Veletta Angolare è un profilo che si installa in angolo tra parete/soffitto o tra due pareti.

Illuminazione verso il basso e verso l'alto indiretta. Ideale per camere, sale, corridoi.

- **Materiale: Alluminio**
- **Potenza max applicabile: 15W/m**
- **Lunghezza barra: 2 metri**
- **Fornito con diffusore opale**

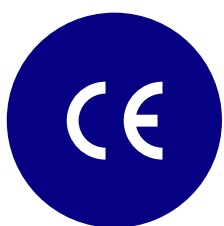

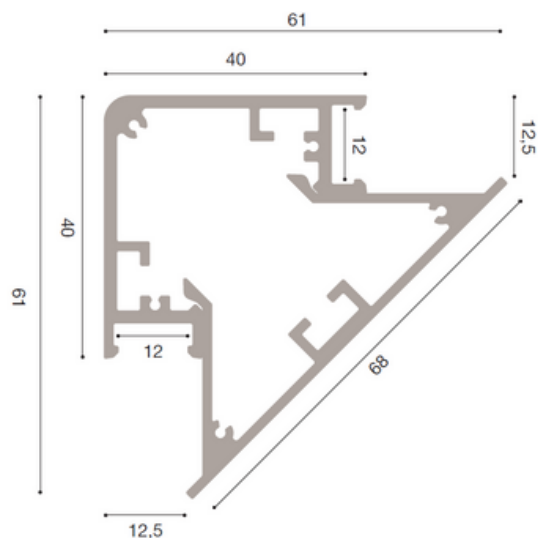
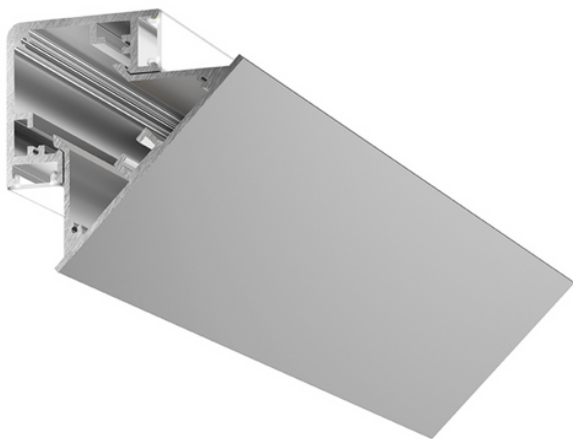

<b>CODICE</b>	<b>NOME</b>
SB103	Bianco
SB104	Nero
SB105	Alluminio
SB106	Kit tappi
SB107	Giunto lineare
SB108	Giunto parete
SB109	Giunto soffitto



# Filo di luce

Il filo di luce è un sistema luminoso da installare tra due pareti. Possibilità di luce monoemissione o biemissione. Ideale per illuminare ambienti con volti, travi e zone con grandi altezze

- **Materiale: Alluminio**
- **Potenza max applicabile: 15W/m**
- **Lunghezza massima: 8 metri**
- **Fornito con diffusore opale**

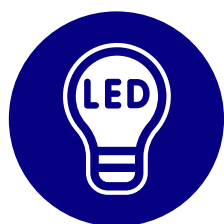
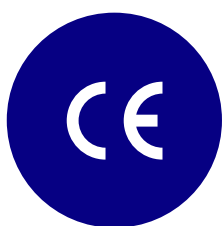

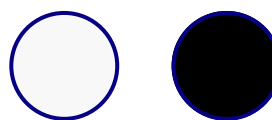
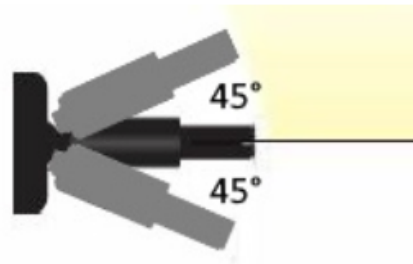

<b>CODICE</b>	<b>NOME</b>
SB110	Mono bianco
SB111	Mono nero
SB112	Biemissione B.CO
SB113	Biemissione Nero



# Retro

Profilo per soffitto e parete con ottica arretrata, ideale per illuminare in modo diffuso azzerando l'effetto abbagliamento.

Dimensioni contenute per un perfetto stile minimal.

- **Materiale: Alluminio**
- **Potenza max applicabile: 20W/m**
- **Lunghezza barra: 3 metri**
- **Fornito con diffusore opale**





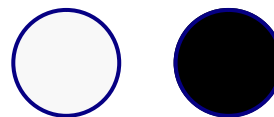
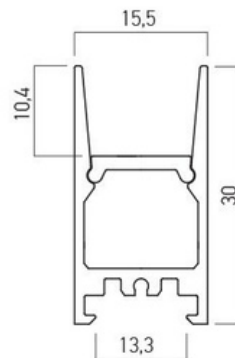
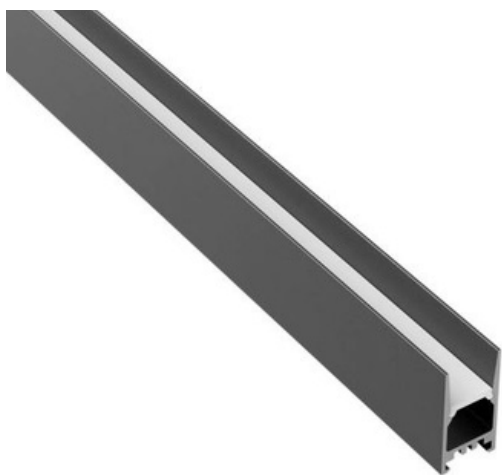

<b>CODICE</b>	<b>NOME</b>
SB114	Bianco
SB115	Nero
SB116	Curva 90° bianco
SB117	Curva 90° nero
SB118	Curva parete soffitto b.co
SB119	Curva parete soffitto nero
SB120	Tappo aperto bianco
SB121	Tappo aperto nero
SB122	Tappo chiuso bianco
SB123	Tappo chiuso nero
SB124	Giunto lineare
SB125	Clip fissaggio

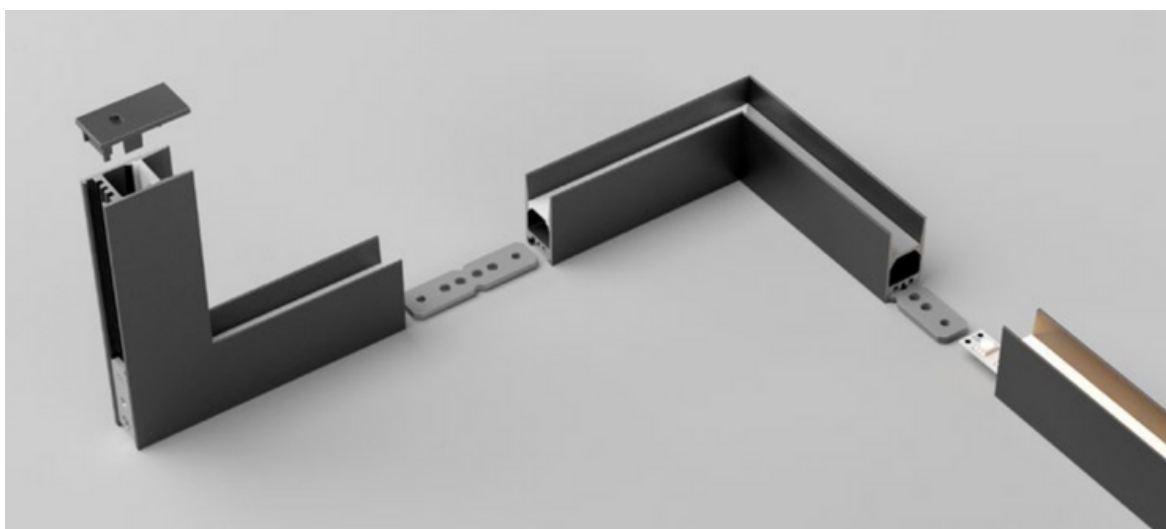

# Micro Profilo H

Micro profilo per mini cobled, ideale per creare effetti luminosi a scomparsa sotto i gradini, dietro a mobili o quinte di cartongesso.

- **Materiale: Alluminio**
- **Potenza max applicabile: 10W/m**
- **Lunghezza massima: 2 metri**
- **Fornito con diffusore opale**

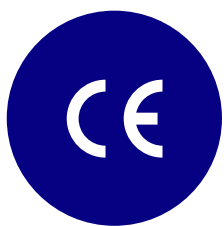
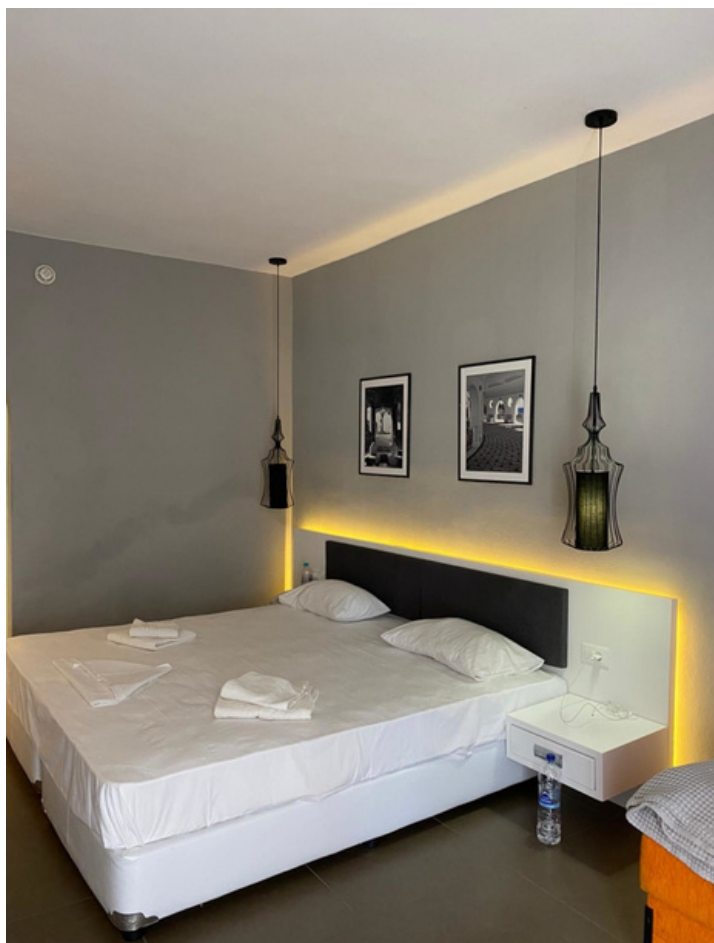

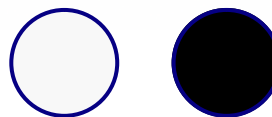
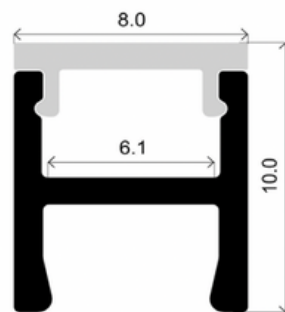

<b>CODICE</b>	<b>NOME</b>
SB126	Bianco
SB127	Nero
SB128	Alluminio
SB128	Kit tappi
SB129	Kit sospensione

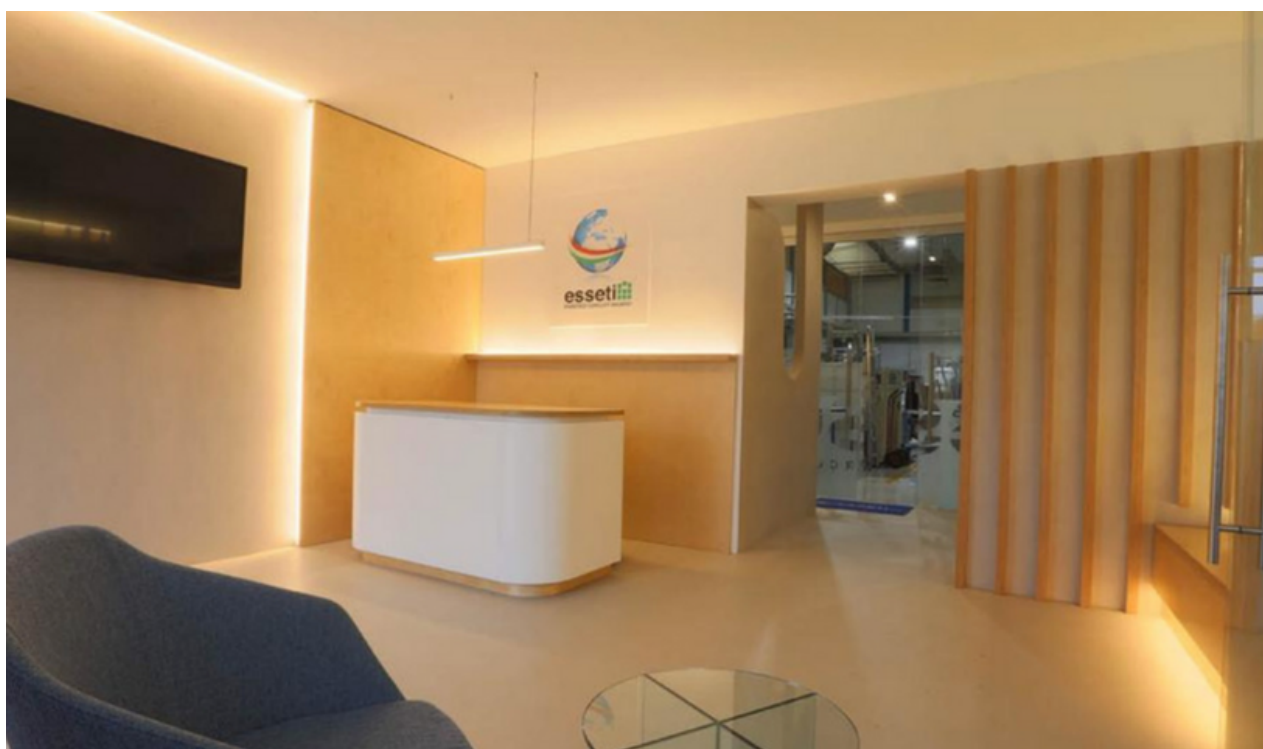

# Micro Profilo U

Micro profilo per mini cobled, perfetto per creare configurazioni luminose in spazi ristretti.

- **Materiale: Alluminio**
- **Potenza max applicabile: 10W/m**
- **Lunghezza barra: 2 metri**
- **Fornito con diffusore opale**

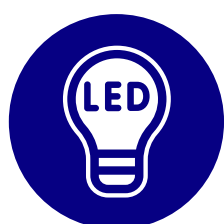
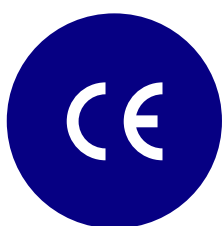

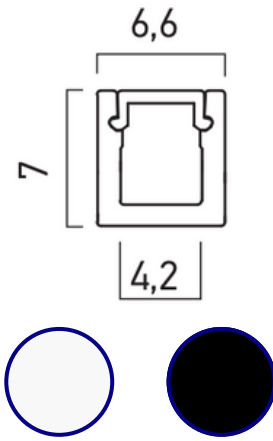
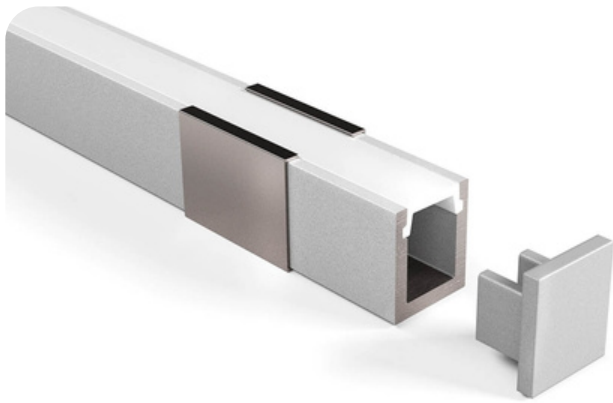

CODICE	NOME
SB130	Alluminio
SB131	Tappo aperto
SB132	Tappo chiuso
SB133	Staffa fissaggio

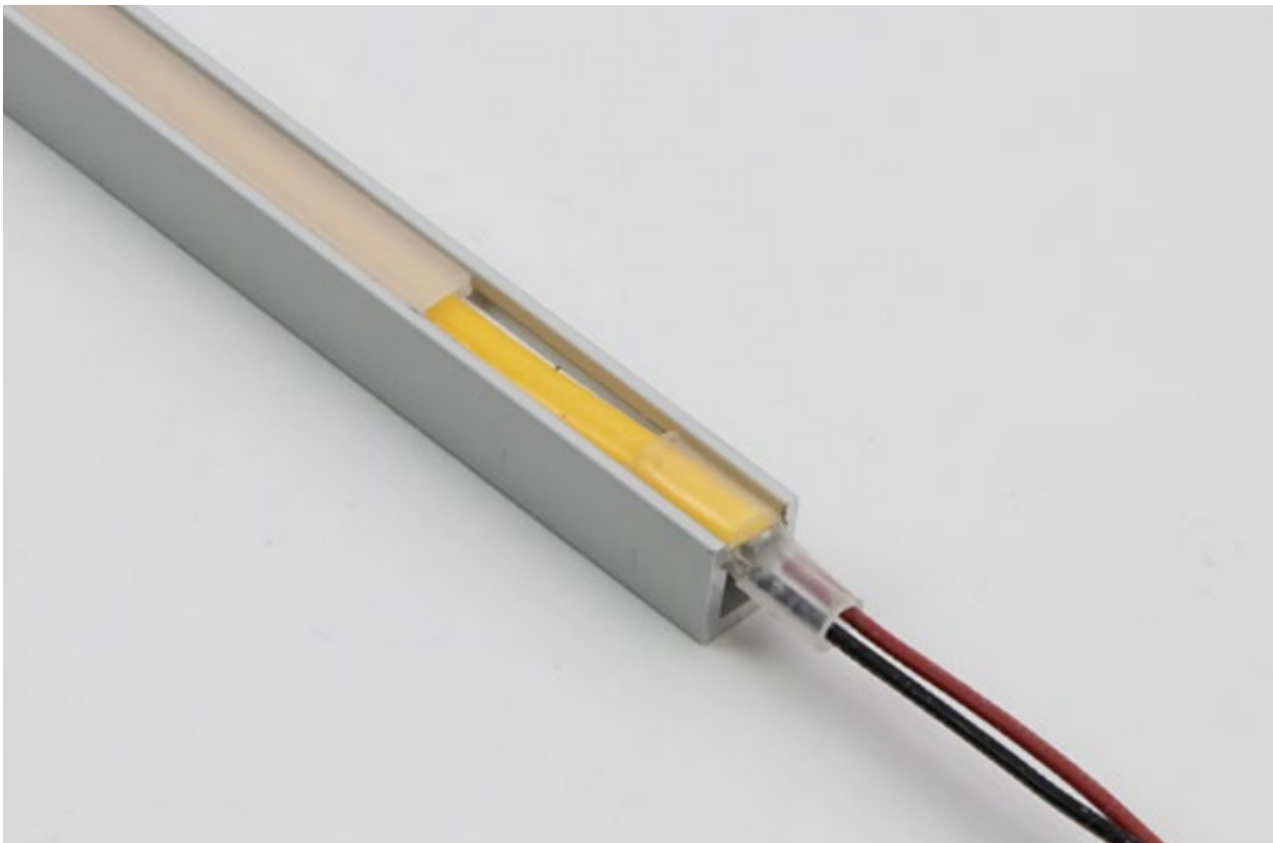

# Micro Profilo Angolare

Micro profilo per mini cobled, perfetto per creare configurazioni luminose in mensole, angoli e zone particolarmente nascoste

- **Materiale: Alluminio**
- **Potenza max applicabile: 10W/m**
- **Lunghezza barra: 2 metri**
- **Fornito con diffusore opale**

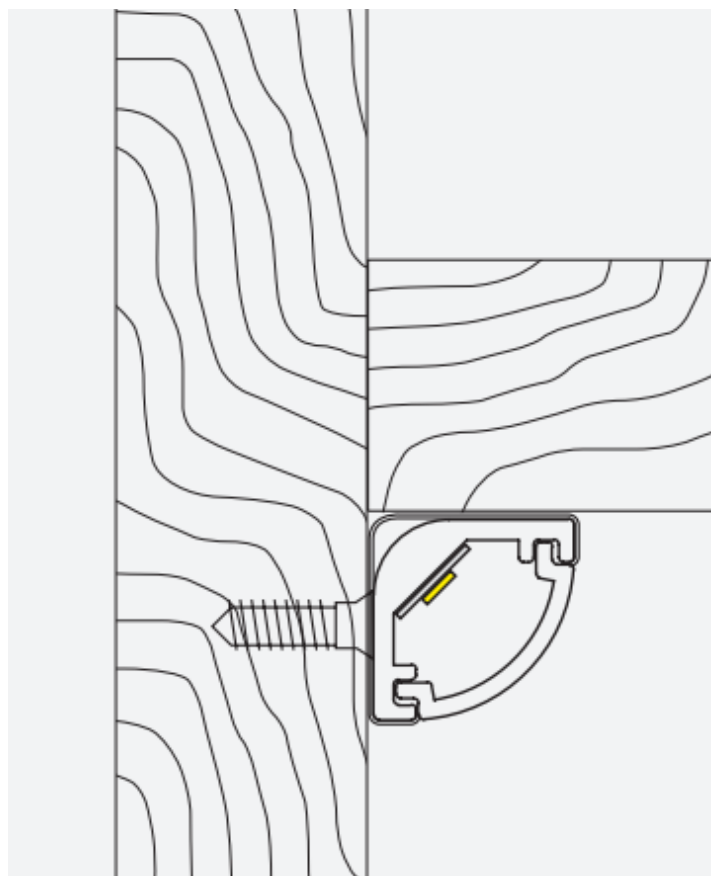
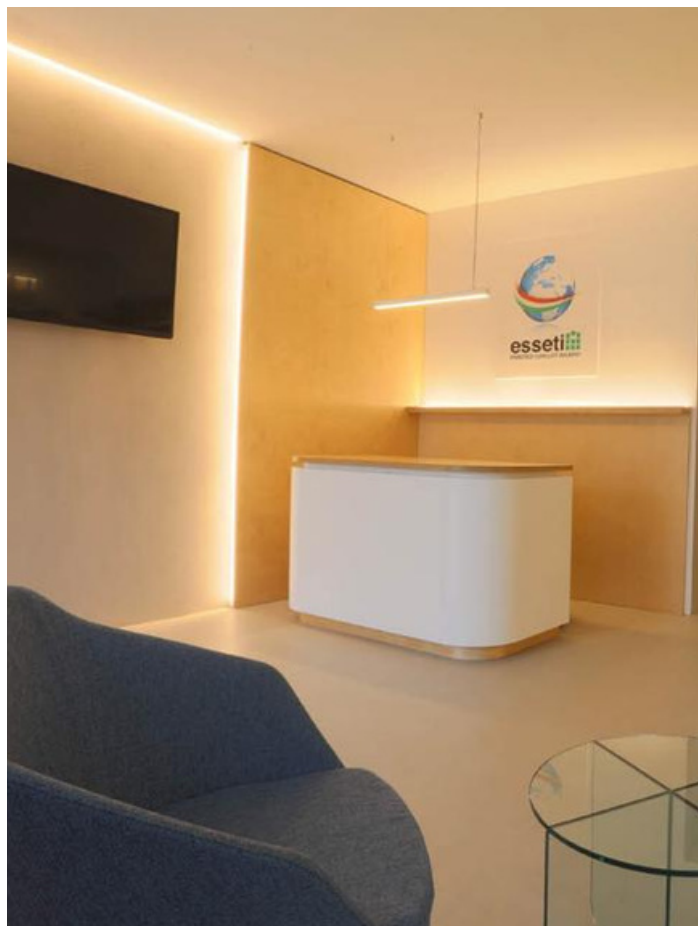
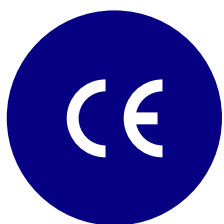

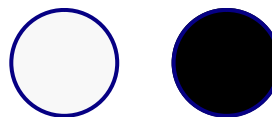
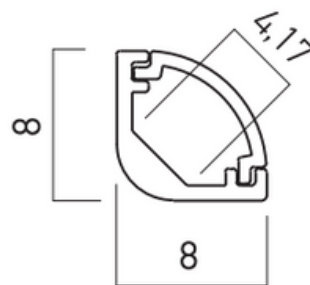
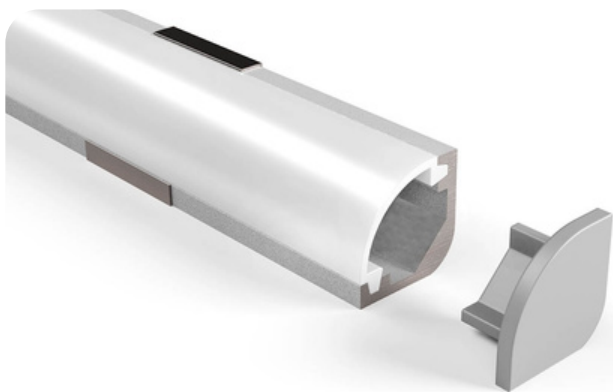

<b>CODICE</b>	<b>NOME</b>
SB134	Alluminio
SB135	Tappo aperto
SB136	Tappo chiuso
SB137	Staffa fissaggio

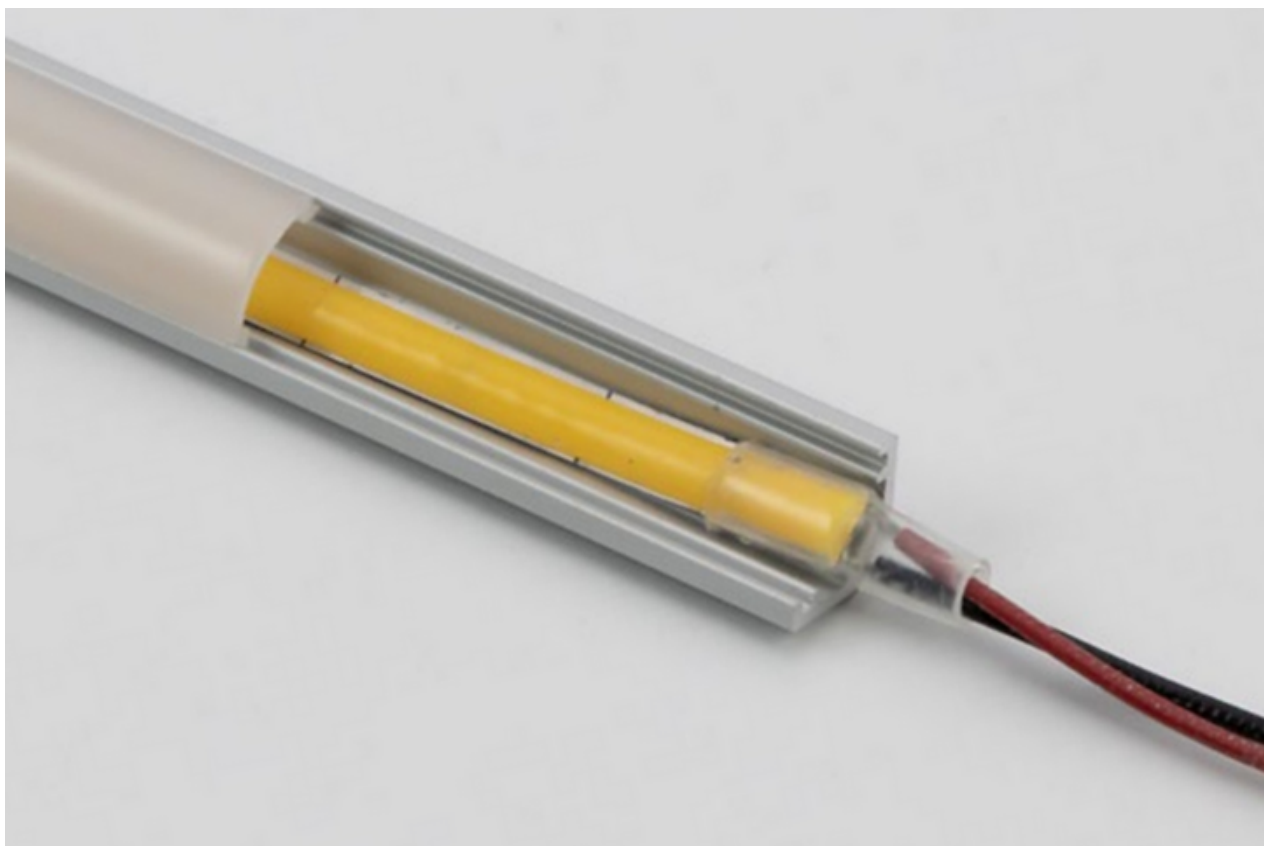

**INCASSO**

**23**

**LIGHTBOOK**

**PROFILI**

**VELETTE**



**INCASSO**

**23**

**LIGHTBOOK**



# Space 7

Lo Space 7 è un profilo dai mille utilizzi. Il suo uso principale è da incasso. Grazie alla sua dimensione entra perfettamente nella lastra di cartongesso. Ideale per illuminare in modo generale ogni ambiente

- **Materiale: Alluminio**
- **Potenza max applicabile: 26W/m**
- **Lunghezza barra: 3 metri**
- **Fornito con diffusore opale**

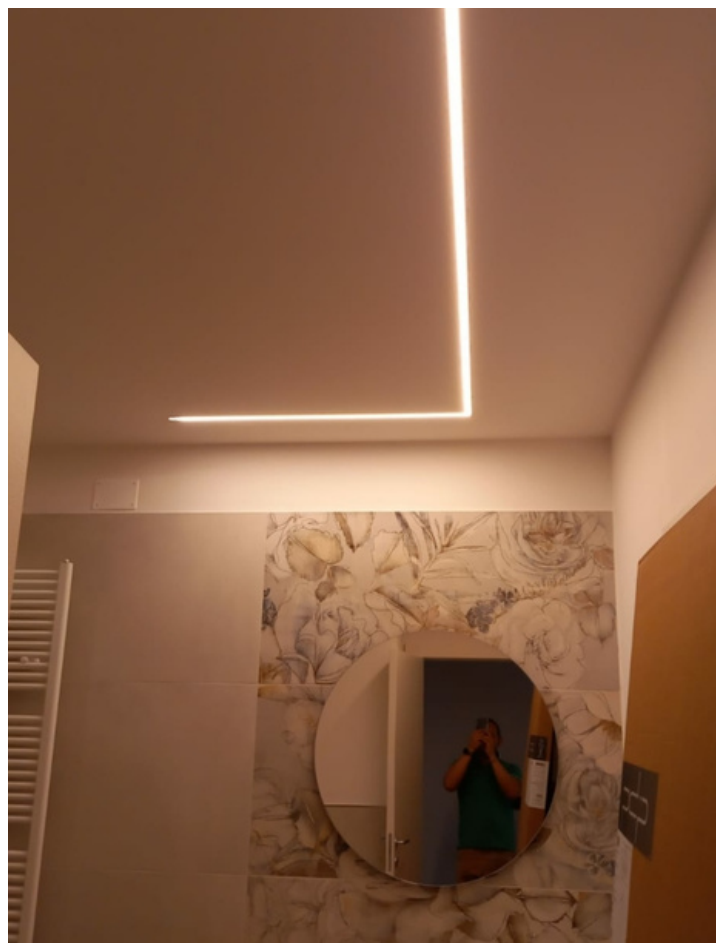
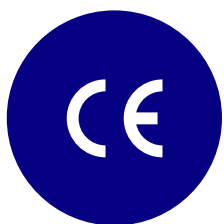

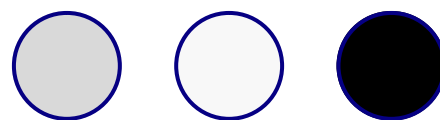
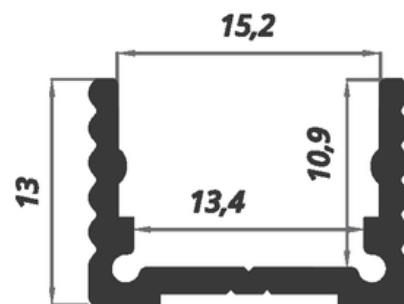
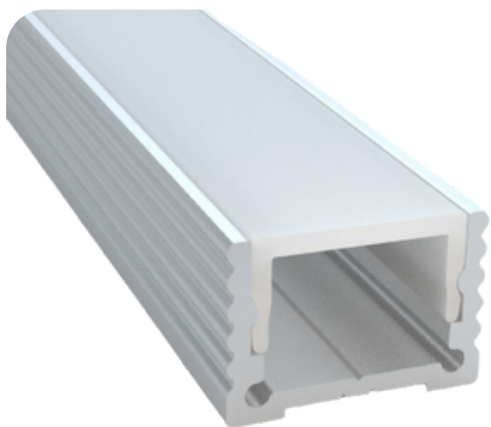

<b>CODICE</b>	<b>NOME</b>
SB138	Alluminio
SB139	Kit Tappi



# Scomparsa

Profilo professionale da incasso per cartongesso o muratura effetto scomparsa.

Le sue alette traforate permettono di essere stuccate alla perfezione. Ideale per illuminare in modo diffuso e generale ogni tipologia di ambiente.

- **Materiale: Alluminio**
- **Potenza max applicabile: 26W/m**
- **Lunghezza barra: 3 metri**
- **Fornito con diffusore opale**

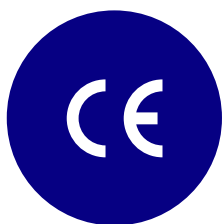

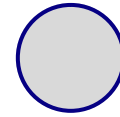
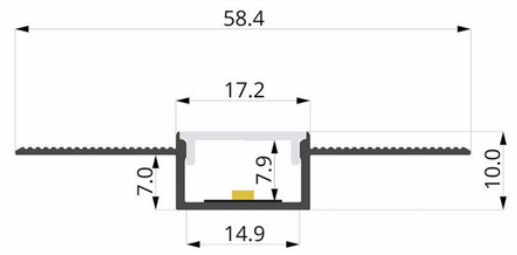
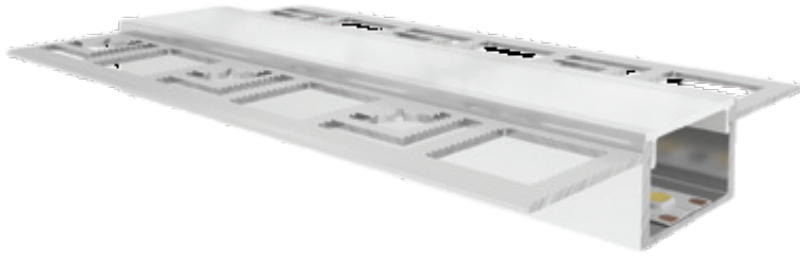

<b>CODICE</b>	<b>NOME</b>
SB140	Alluminio
SB141	Kit Tappi



# Cartongesso

Profilo ad incasso annegato in una lastra di cartongesso da 2mt. Questa caratteristica gli permette di essere installato con facilità e con grande precisione. Ideale per illuminare in modo diffuso e generale qualsiasi ambiente

- **Materiale:**  
**Cartongesso+Alluminio**
- **Potenza max applicabile: 26W/m**
- **Lunghezza barra:**  
**3 metri**
- **Fornito con diffusore opale**



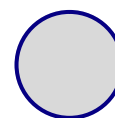
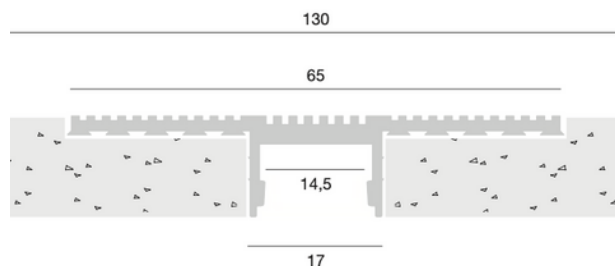
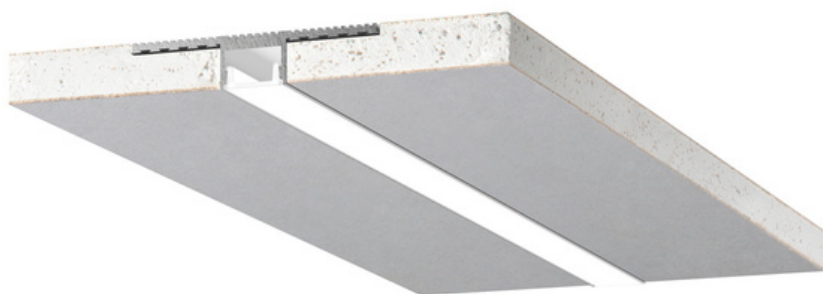

<b>CODICE</b>	<b>NOME</b>
SB142	Cartongesso
SB143	Curva 90°
SB144	Giunto T
SB145	Croce



# Ghost

Profilo ad incasso con ottica arretrata. Ideale per effetti anti abbagliamento, per non vedere la sorgente luminosa. Totale comfort visivo ed effetto a scomparsa totale. Da installare in fase di realizzazione cartongesso

- **Materiale: Alluminio verniciato bianco**
- **Potenza max applicabile: 20W/m**
- **Lunghezza barra: 3 metri**
- **Fornito con diffusore opale**

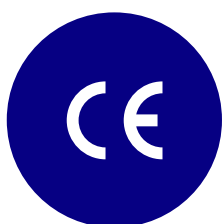



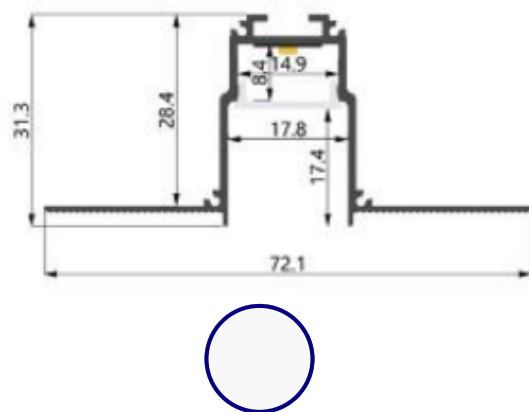

<b>CODICE</b>	<b>NOME</b>
SB376	Profilo
SB386	Kit tappi
SB377	Giunto lineare
SB378	Giunto Angolare



# Space 8

Profilo ad incasso super sottile. Può essere inserito in mensole, cartongesso e in alcuni casi nella muratura, grazie alle sue dimensioni minimali.

- **Materiale: Alluminio**
- **Potenza max applicabile: 26W/m**
- **Lunghezza barra: 3 metri**
- **Fornito con diffusore opale**

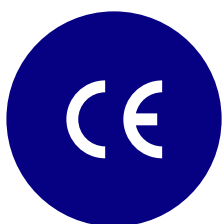

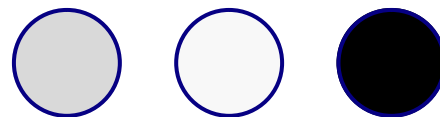
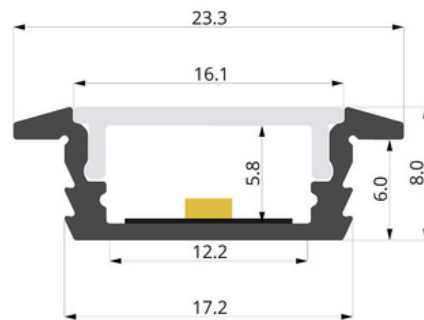
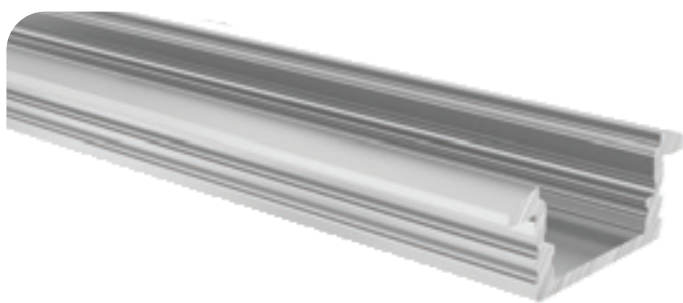

<b>CODICE</b>	<b>NOME</b>
SB146	Alluminio
SB147	Kit Tappi



# Gola Luminosa

Profilo ad incasso per gole luminose a scomparsa. Installazione tra lastra di cartongesso e parete. Effetto spettacolare per valorizzare rivestimenti, pitture, pareti.

- **Materiale: Alluminio**
- **Potenza max applicabile: 30W/m**
- **Lunghezza barra: 3 metri**
- **Fornito con diffusore opale**

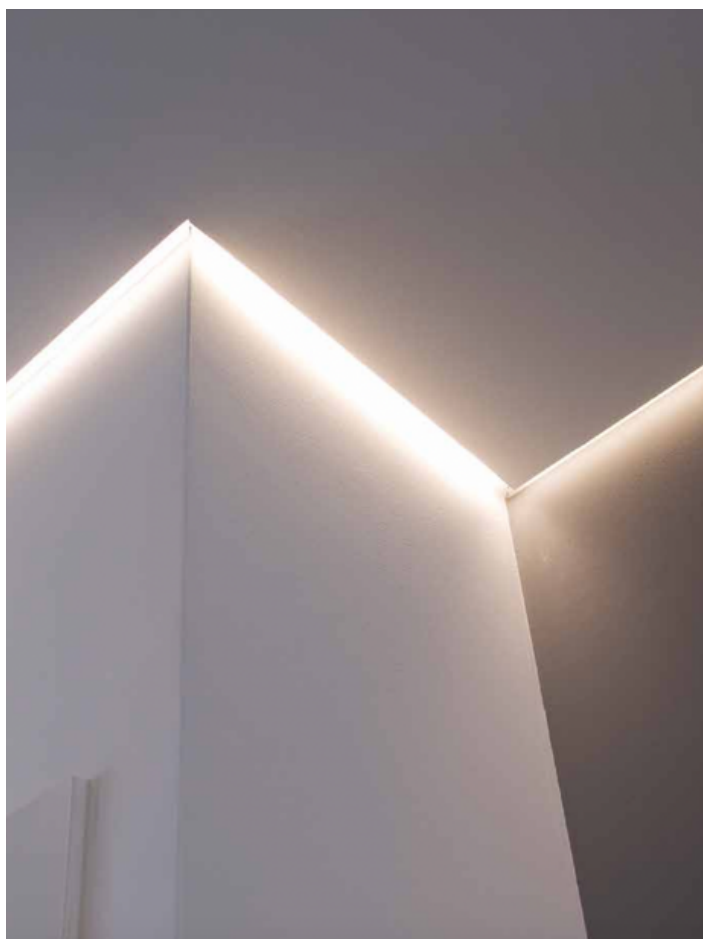
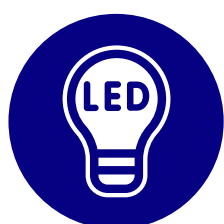

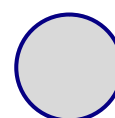
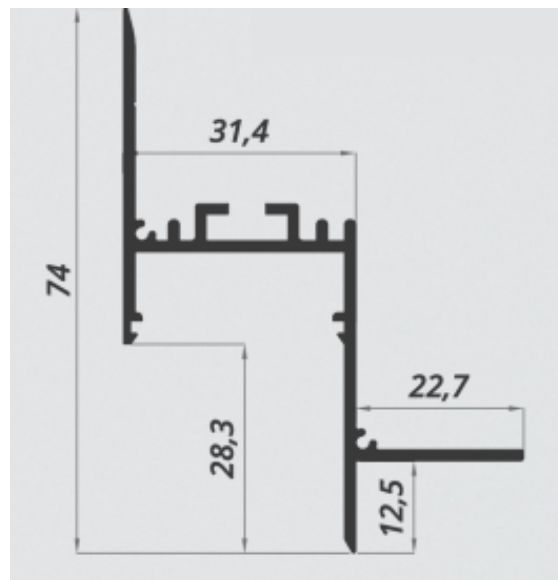

<b>CODICE</b>	<b>NOME</b>
SB148	Alluminio



# Mini Gola Luminosa

Profilo ad incasso per gole luminose a scomparsa. Installazione tra lastra di cartongesso e parete. Effetto spettacolare per valorizzare rivestimenti, pitture, pareti.

- **Materiale: Alluminio**
- **Potenza max applicabile: 30W/m**
- **Lunghezza barra: 3 metri**
- **Fornito con diffusore opale**

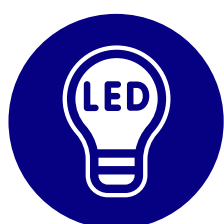

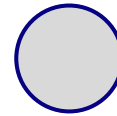
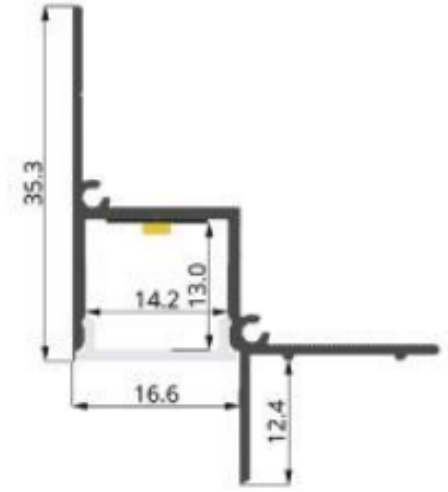

<b>CODICE</b>	<b>NOME</b>
SB379	Alluminio



# Linea Smart

Profilo ad incasso per ogni utilizzo: muratura, cartongesso, incasso a terra, incasso per ceramiche. Anima interna per installazione stripled rapida. Calpestabile IP65. Un profilo per tutte le occasioni

- **Materiale: Alluminio**
- **Potenza max applicabile: 26W/m**
- **Lunghezza barra: 3 metri**
- **Fornito con diffusore opale e anima per led.**





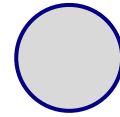
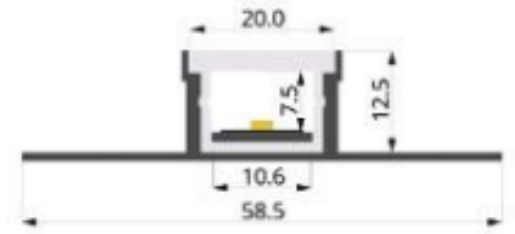

<b>CODICE</b>	<b>NOME</b>
SB380	Profilo Completo
SB381	Kit tappi silicone



# Micro Profilo Incasso

Micro profilo ad incasso può essere incassato su ogni superficie per creare effetti lineari minimali e spettacolari. Utilizzare la nostra speciale micro striped per avere effetto uniforme

- **Materiale: Alluminio**
- **Potenza max applicabile: 10W/m**
- **Lunghezza barra: 2 metri**
- **Fornito con diffusore opale**

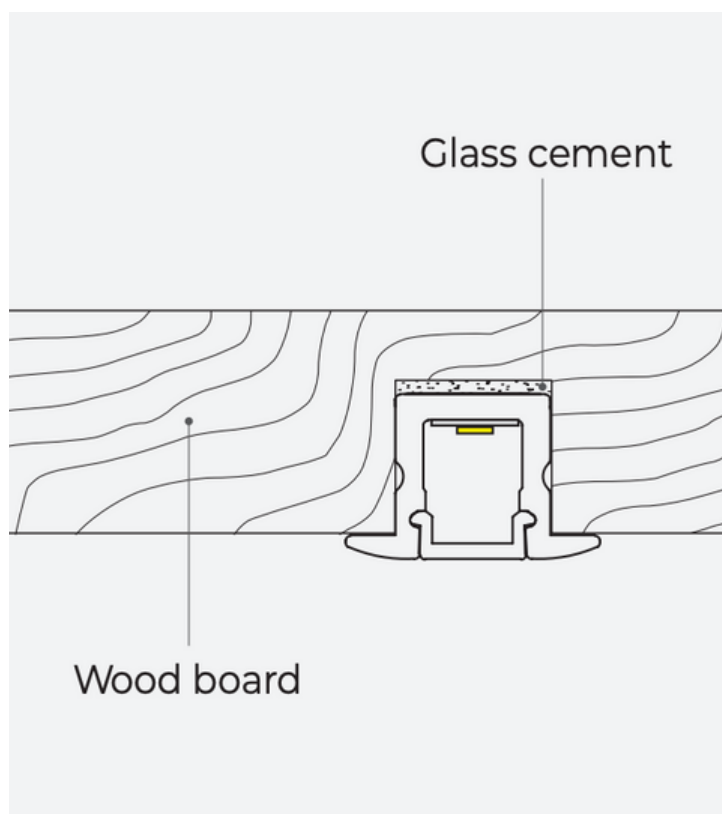

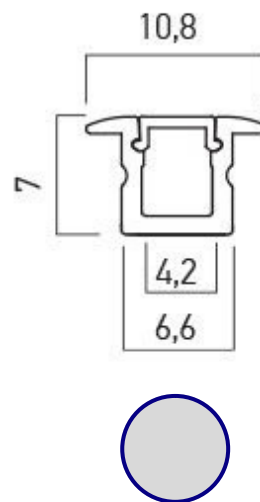
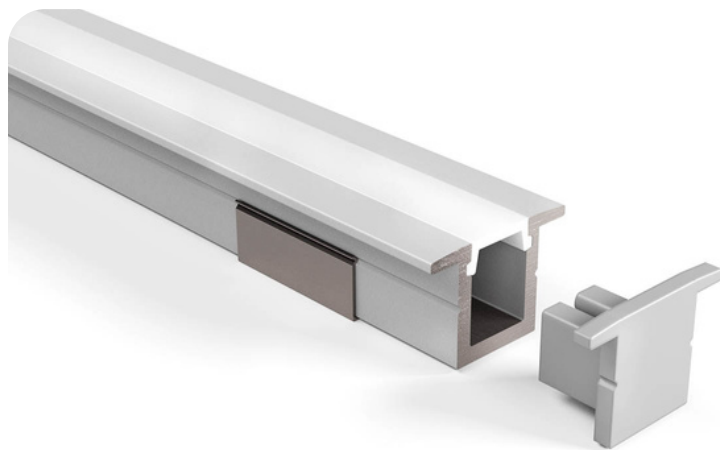

<b>CODICE</b>	<b>NOME</b>
SB149	Alluminio
SB150	Tappo aperto
SB151	Tappo chiuso
SB152	Clip fissaggio

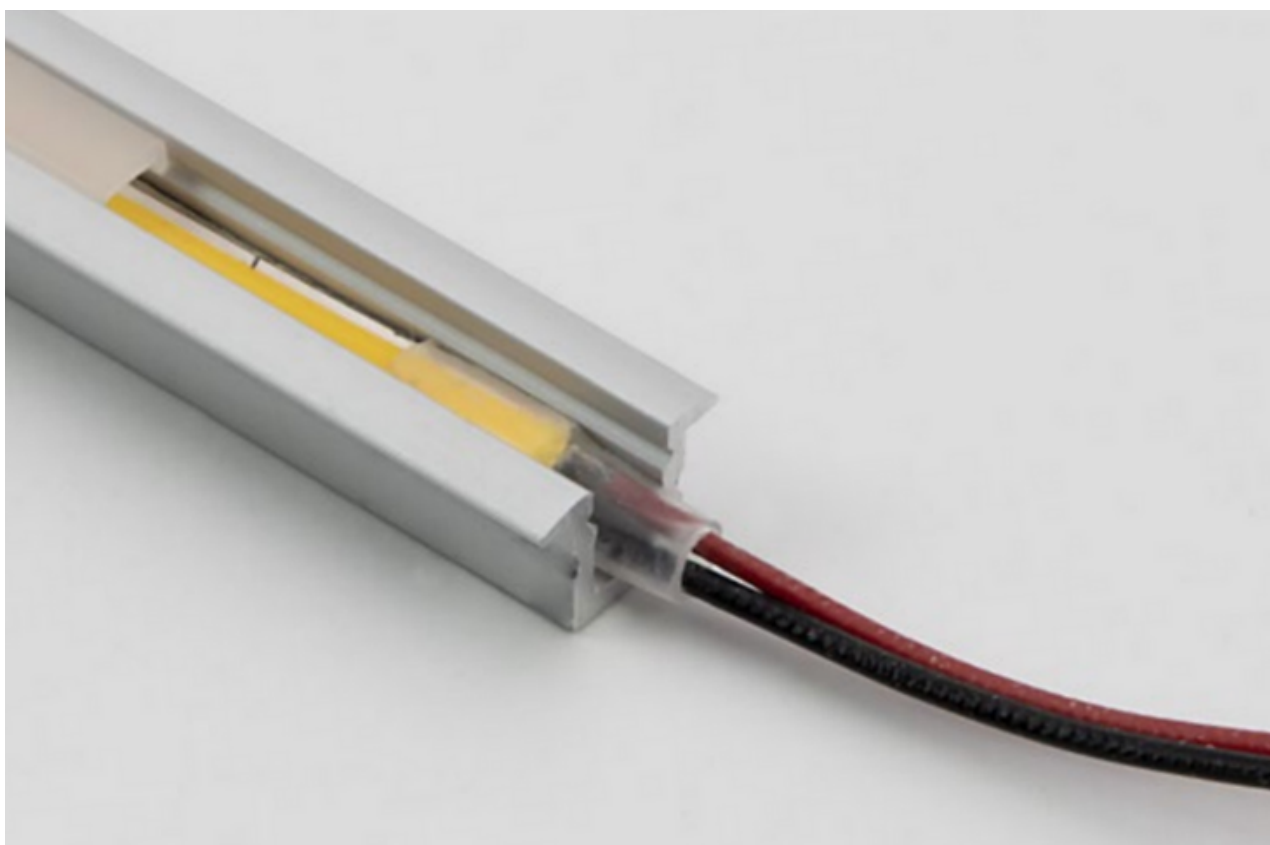

# Micro Profilo Asimmetrico

Micro profilo asimmetrico è perfetto per illuminare a scomparsa mensole o camminamenti installandolo a parete. Utilizzare la nostra speciale micro stripled per avere effetto uniforme

- Materiale: Alluminio
- Potenza max applicabile: 10W/m
- Lunghezza barra: 2 metri
- Fornito con diffusore opale



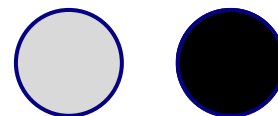
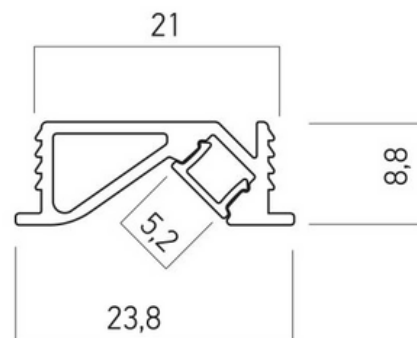

<b>CODICE</b>	<b>NOME</b>
SB152	Colore bianco
SB153	Colore nero
SB154	Kit tappi bianco
SB155	Kit tappi nero

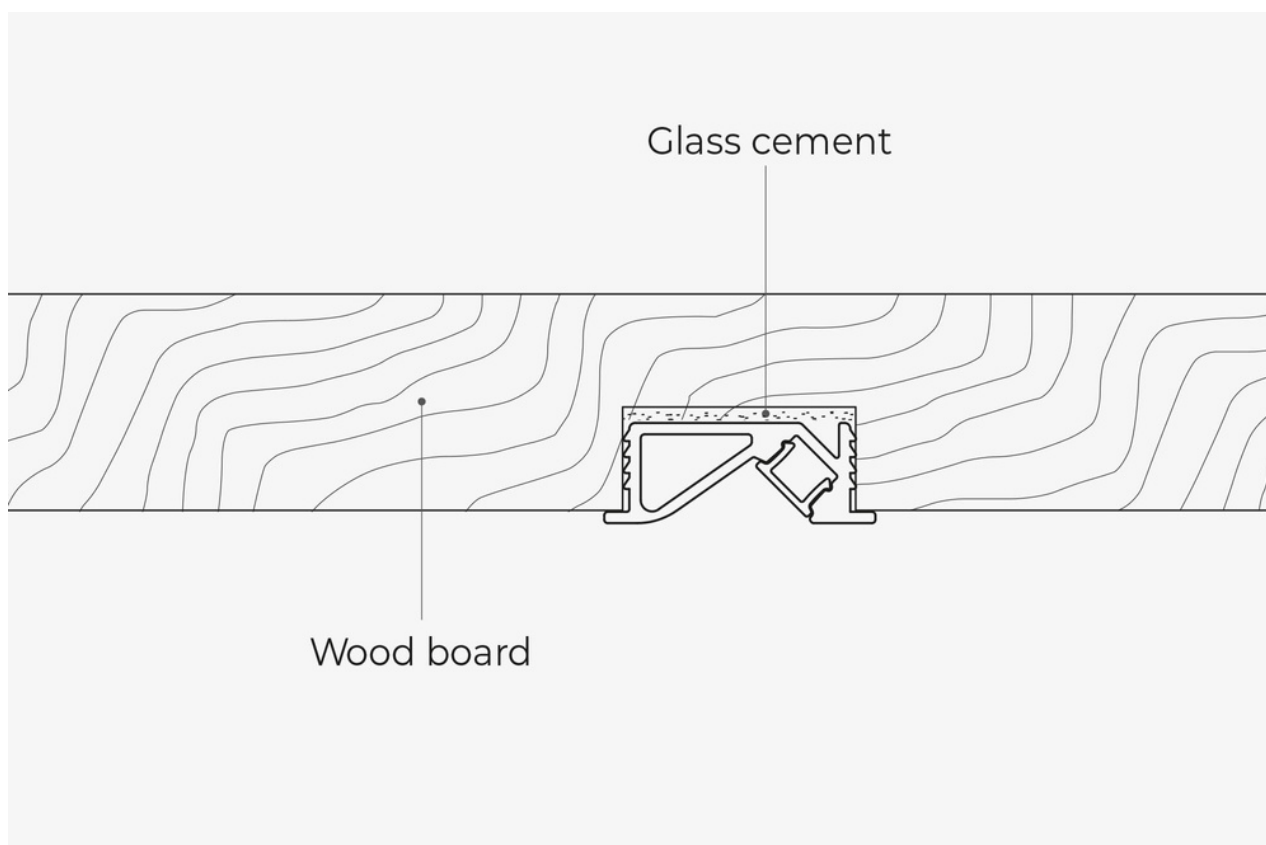

# Linea Terra

Linea Terra è un profilo ad incasso per interni ed esterni ideale per incasso a terra. Perfetto per creare effetti luminosi in ogni ambiente. Ottimo per segnalare percorsi.

- **Materiale: Alluminio**
- **Potenza max applicabile: 15W/m**
- **Lunghezza barra: fino a 3 metri**
- **Fornito con diffusore opale**

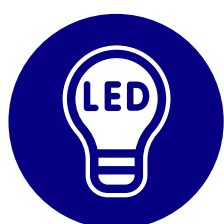
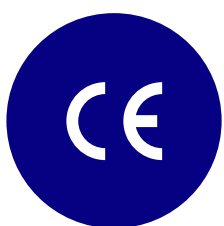
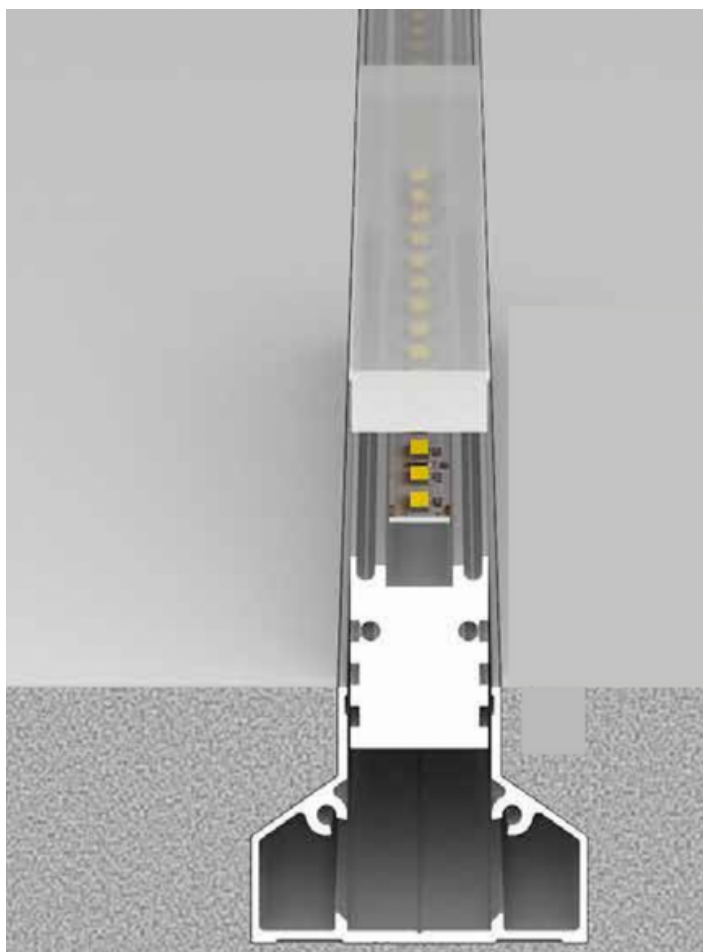

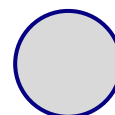
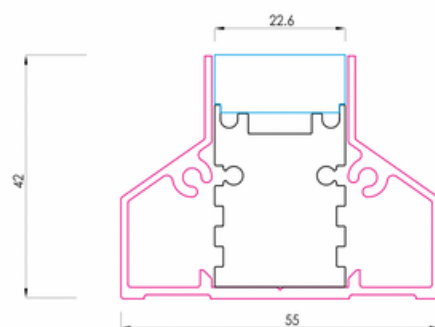
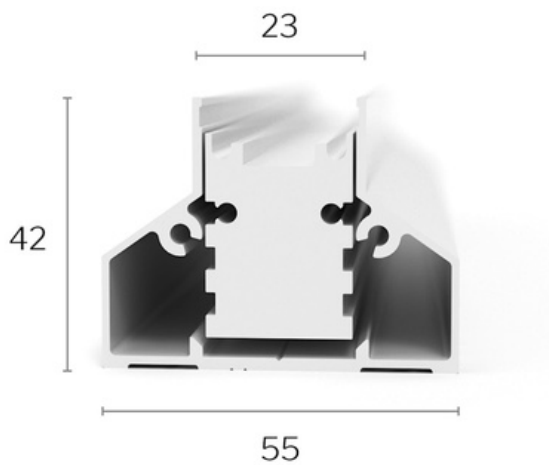

CODICE	NOME
SB156	Alluminio

