

**PARETE
SOFFITTO**

23

LIGHTBOOK



**PARETE
SOFFITTO**

**PARETE
SOFFITTO**

23

LIGHTBOOK



QUADRO LED

Lampada da soffitto/parete con luce diffusa generale. Ideale per illuminare grandi ambienti senza abbagliare. Disponibile in varie misure e potenze. Corpo in alluminio e schermo opale.

- Illuminazione generale
- Illuminazione grandi spazi
- Interno IP20
- Schermo opale

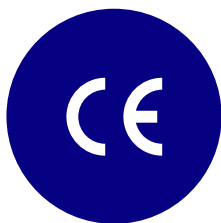



CODICE	W	lm	K	CRI	FASCIO	COLORE	MISURA
SB263	40	3329	3000	85	110	Bianco	40x40cm
SB264	40	3529	4000	85	110	Bianco	40x40cm
SB265	50	4079	3000	85	110	Bianco	50x50cm
SB266	50	4329	4000	85	110	Bianco	50x50cm
SB267	60	4949	3000	85	110	Bianco	60x60cm
SB268	60	5249	4000	85	110	Bianco	60x60cm

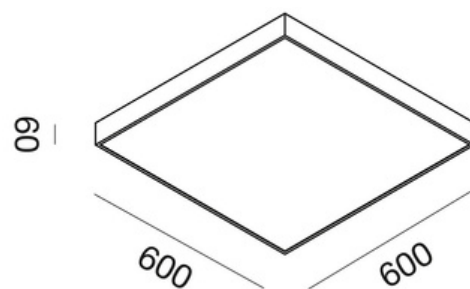
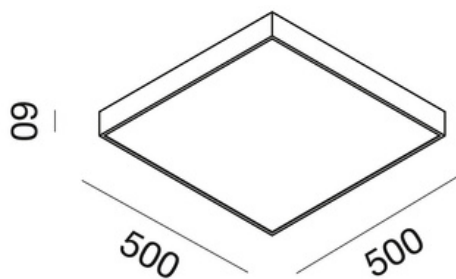
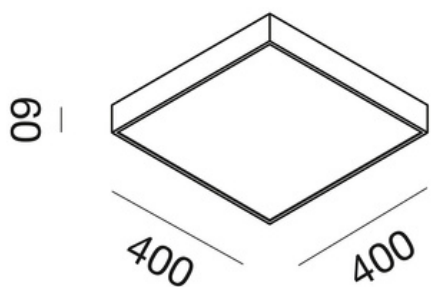

LUNA LED

Lampada da soffitto/parete con luce diffusa generale. Ideale per illuminare grandi ambienti senza abbagliare. Disponibile in varie misure e potenze. Corpo in alluminio e schermo opale.

- Illuminazione generale
- Illuminazione grandi spazi
- Interno IP20
- Schermo opale

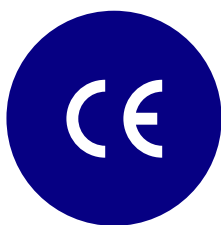



CODICE	W	lm	K	CRI	FASCIO	COLORE	MISURA
SB269	40	3329	3000	85	110	Bianco	40cm
SB270	40	3529	4000	85	110	Bianco	40cm
SB271	50	4079	3000	85	110	Bianco	50cm
SB272	50	4329	4000	85	110	Bianco	50cm
SB273	60	4949	3000	85	110	Bianco	60cm
SB274	60	5249	4000	85	110	Bianco	60cm

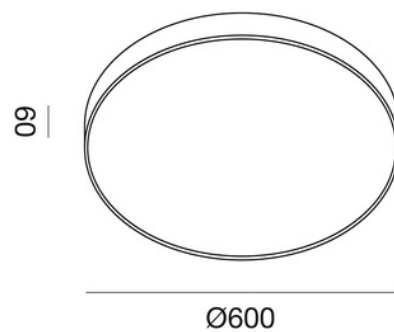
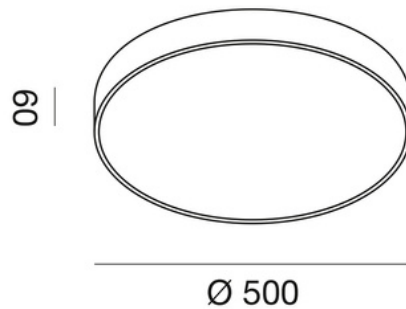
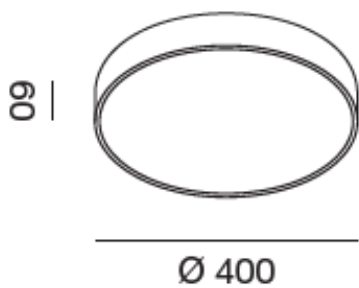

ART ZOOM

Faretto orientabile da soffitto/parete. UGR<16 grazie al suo nido d'ape incorporato. Ottica zoom per variare fascio luminoso da 15° a 45°. Perfetto per illuminare grandi spazi e piccoli dettagli grazie alle sue potenze e dimensioni.

- Illuminazione generale
- Illuminazione grandi spazi
- UGR<16
- Ottica ZOOM

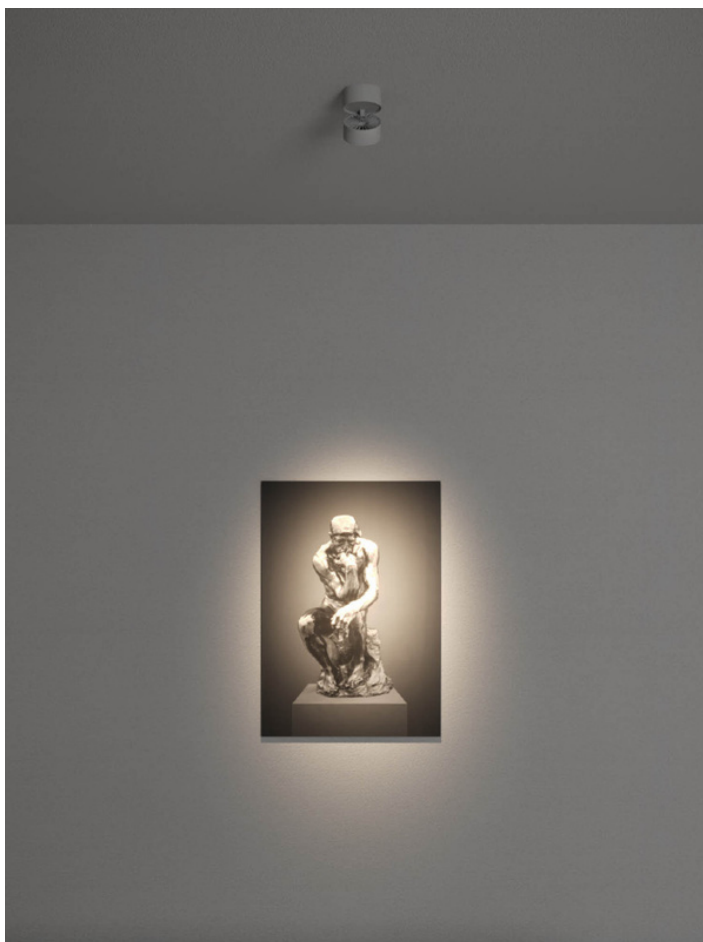
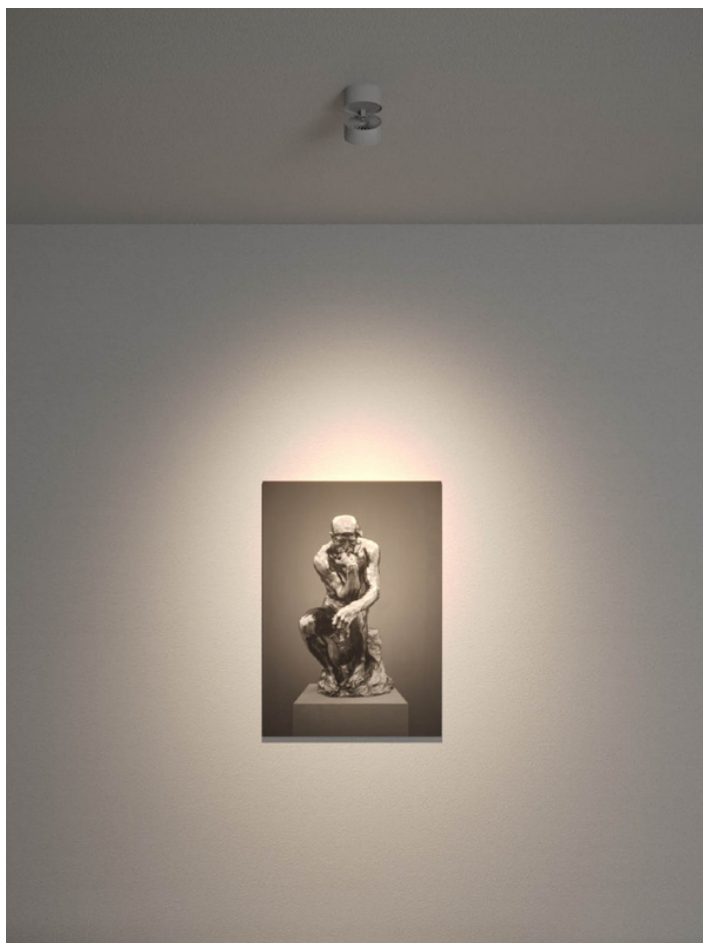
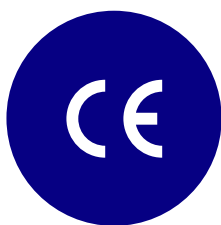



CODICE	W	lm	K	CRI	FASCIO	COLORE	MISURA
SB275	18	2220	3000	90	15-45	Bianco	8cm
SB276	18	2220	3000	90	15-45	Nero	8cm
SB277	18	2340	4000	90	15-45	Bianco	8cm
SB278	18	2340	4000	90	15-45	Nero	8cm
SB279	28	3440	3000	90	15-45	Bianco	10cm
SB280	28	3440	3000	90	15-45	Nero	10cm
SB279	28	3640	4000	90	15-45	Bianco	10cm
SB280	28	3640	4000	90	15-45	Nero	10cm

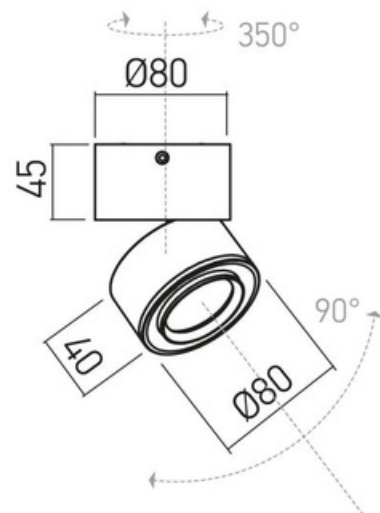
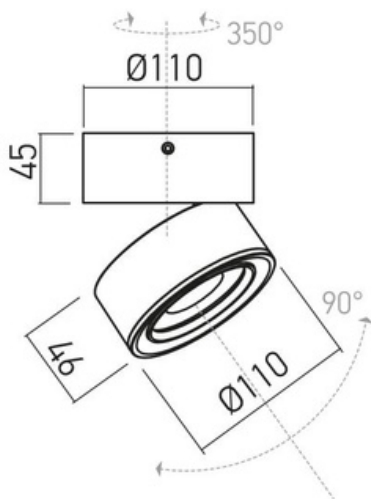

RAY

Famiglia di cilindri e cubetti a soffitto. Led integrato e ottica arretrata per evitare abbagliamento. Struttura in alluminio verniciato in bianco o nero. Ideali per illuminare ambienti in composizione o singolarmente.

- Illuminazione puntuale
- Spazi residenziali
- Ottica arretrata
- Struttura in alluminio





CODICE	W	lm	K	CRI	FASCIO	COLORE	MISURA
SB283	6	780	3000	85	38	Bianco	7cm
SB284	6	840	4000	85	38	Bianco	7cm
SB285	6	780	3000	85	38	Nero	7cm
SB286	6	840	4000	85	38	Nero	7cm
SB287	18	1397	3000	85	38	Bianco	10cm
SB288	18	1489	4000	85	38	Bianco	10cm
SB289	18	1397	3000	85	38	Nero	10cm
SB290	18	1489	4000	85	38	Nero	10cm

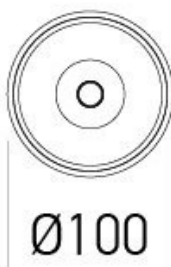



CODICE	W	lm	K	CRI	FASCIO	COLORE	MISURA
SB291	6	780	3000	85	38	Bianco	7cm
SB292	6	840	4000	85	38	Bianco	7cm
SB293	6	780	3000	85	38	Nero	7cm
SB294	6	840	4000	85	38	Nero	7cm
SB295	18	1397	3000	85	38	Bianco	10cm
SB296	18	1489	4000	85	38	Bianco	10cm
SB297	18	1397	3000	85	38	Nero	10cm
SB298	18	1489	4000	85	38	Nero	10cm

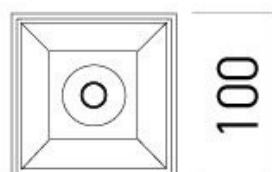

JAY

Famiglia di cubetti a soffitto orientabili.
Cablaggio GU10.
Struttura in alluminio verniciato in bianco o nero. Ideali per illuminare ambienti in composizione o singolarmente.

- Illuminazione puntuale
- Spazi residenziali
- Ottica orientabile
- Struttura in alluminio

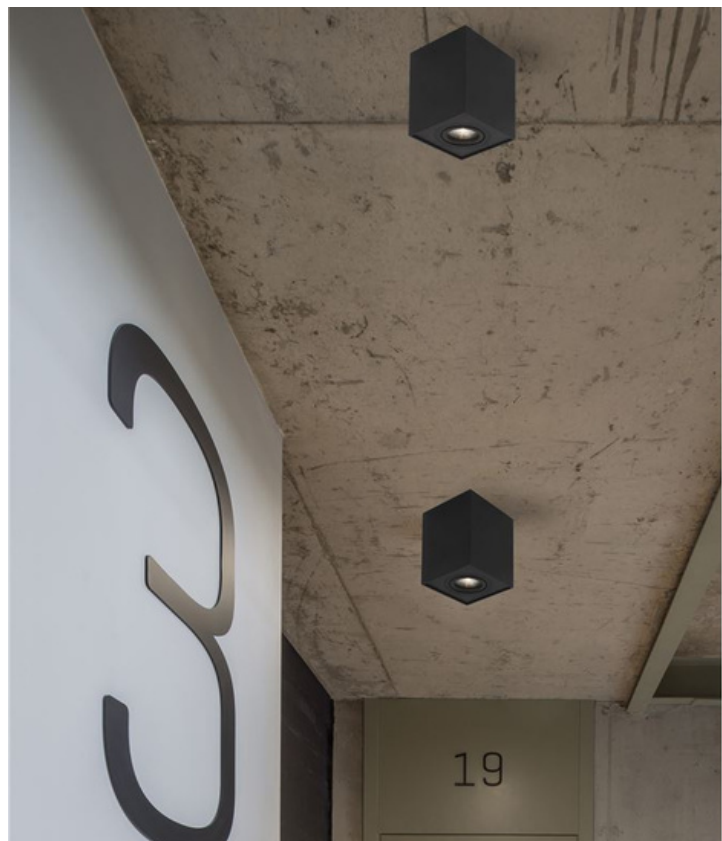
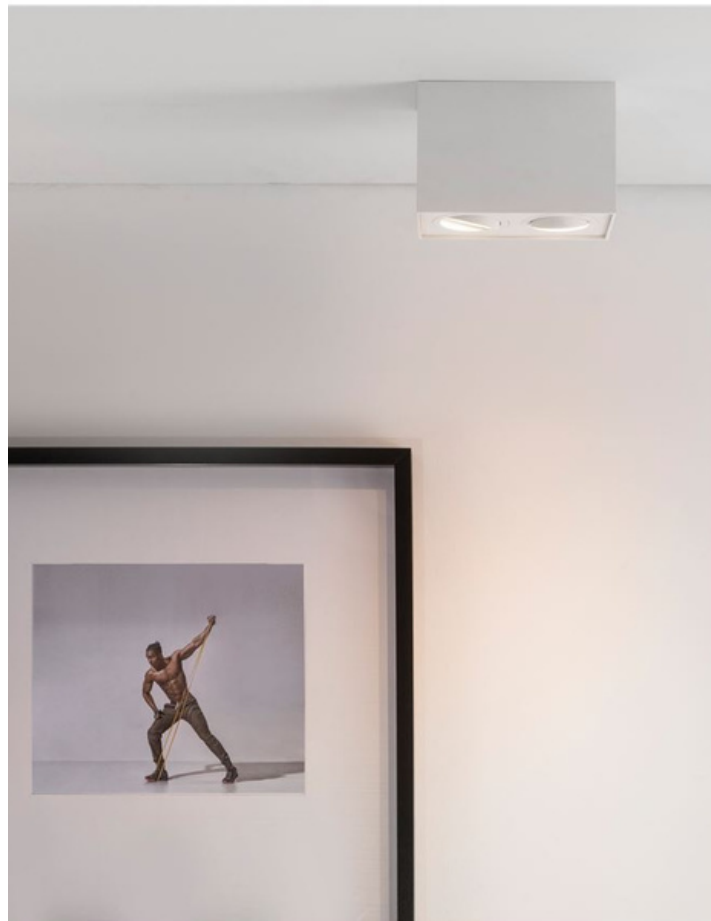
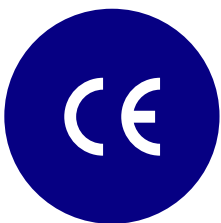



CODICE	W	lm	K	CRI	FASCIO	COLORE	MISURA
SB356	GU10	780	3000	85	38	Bianco	Singolo
SB357	GU10	780	3000	85	38	Nero	Singolo
SB358	GU10	1400	3000	85	38	Bianco	Doppio
SB359	GU10	1400	3000	85	38	Nero	Doppio

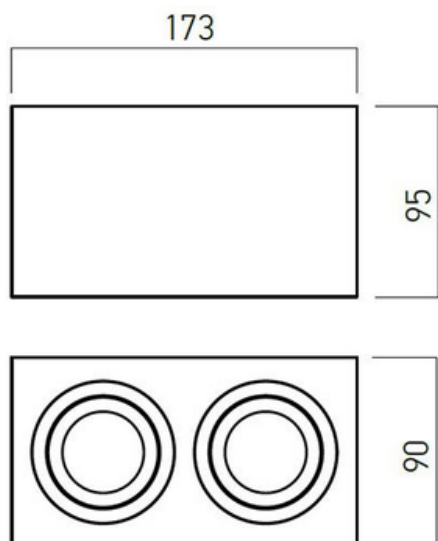

BLADE

Lampada a soffitto con ottiche antiabbagliamento. Linea minimale e pulita. Ideale per illuminare in modo perpendicolare tavoli, zone di passaggio, zone di lettura o conversazione.

- Illuminazione puntuale
- Spazi residenziali
- UGR<16
- Struttura in alluminio





CODICE	W	lm	K	CRI	FASCIO	COLORE	MISURA
SB299	13	1200	3000	90	30	Bianco	13,5cm
SB300	13	1200	3000	90	30	Nero	13,5cm

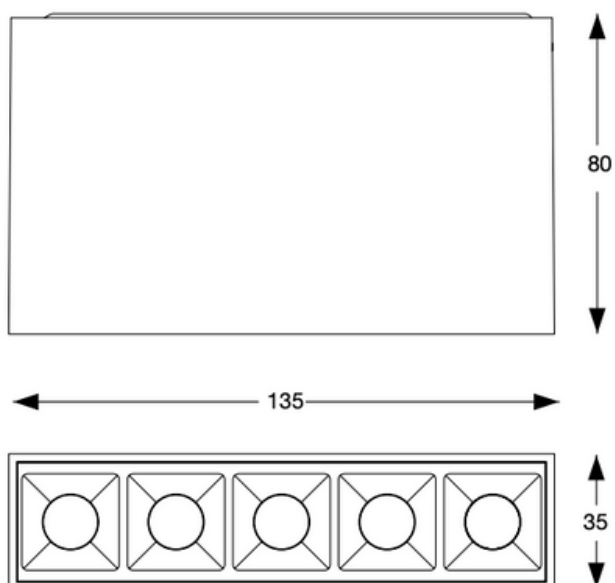

FARY

Lampada a soffitto e parete con faretti orientabili.
Ideale per illuminare in modo generale tavoli, zone di passaggio, zone di lettura o conversazione.

- Illuminazione generale
- Spazi residenziali
- faretti orientabili
- Struttura in alluminio

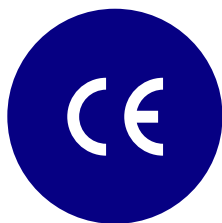



CODICE	W	lm	K	CRI	FASCIO	COLORE	MISURA
SB301	7	750	3000	85	38	Bianco	7cm
SB302	7	750	3000	85	38	Nero	7cm
SB303	14	1500	3000	85	38	Bianco	31cm
SB304	14	1500	3000	85	38	Nero	31cm
SB305	21	2250	3000	85	38	Bianco	54cm
SB306	21	2250	3000	85	38	Nero	54cm
SB307	28	3000	3000	85	38	Bianco	76cm
SB308	28	3000	3000	85	38	Nero	76cm

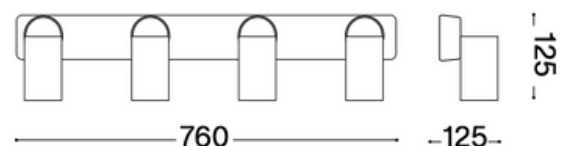
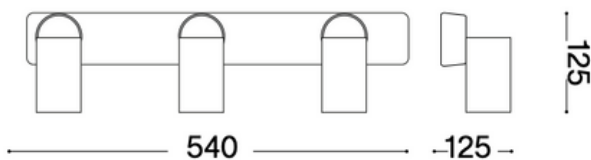
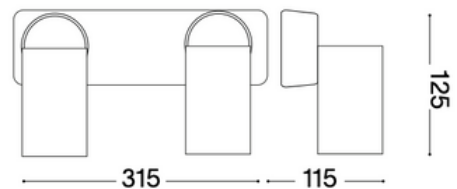
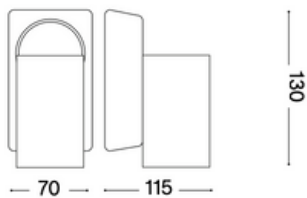

LINEAR

Lampada lineare da 1mt e da 2mt.
Alimentatore a bordo,
struttura in alluminio
verniciato bianco o
nero. Accessori per
sospensione inclusi.
Ideale per illuminare in
modo generale
qualsiasi ambiente.

- Illuminazione generale
- Spazi residenziali e commerciali
- Schermo opale
- Struttura in alluminio





CODICE	W	lm	K	CRI	FASCIO	COLORE	MISURA
SB309	26	3650	3000	85	110	Bianco	1mt
SB310	26	3650	4000	85	110	Bianco	1mt
SB312	26	2030	3000	85	110	Nero	1mt
SB313	26	2030	4000	85	110	Nero	1mt
SB314	52	7300	3000	85	110	Bianco	2mt
SB315	52	7300	4000	85	110	Bianco	2mt
SB316	52	4060	3000	85	110	Nero	2mt
SB317	52	4060	4000	85	110	Nero	2mt

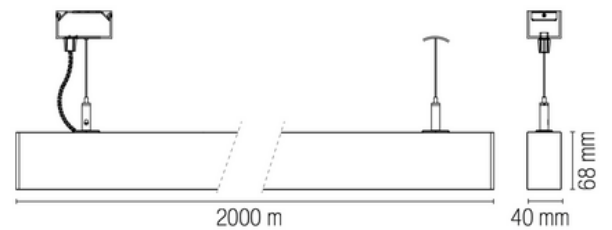
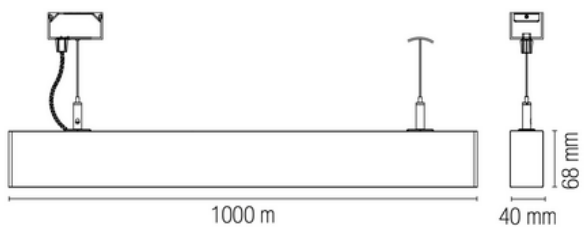



NET

Lampada da parete con schermo basculante. Led integrato, struttura in alluminio verniciato corten o bianco. Ideale per illuminare con effetto biemissione ambienti residenziali

- Illuminazione generale
- Schermo basculante
- Spazi residenziali
- Struttura in alluminio





CODICE	W	lm	K	CRI	FASCIO	COLORE	MISURA
SB317	10	1300	3000	85	110	Bianco	35cm
SB318	10	1300	3000	85	110	Corten	35cm

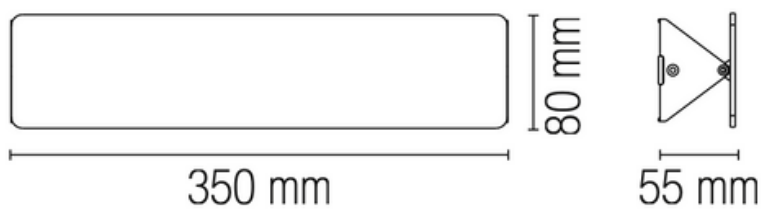



FOIL

Lampada da parete per illuminazione indiretta verso l'alto. Disponibile in due misure, ideale per illuminare in modo generale ambienti residenziali.

Struttura in alluminio verniciato bianco, ottone o titanio.

- Illuminazione generale
- Ottica indiretta
- Spazi residenziali
- Struttura in alluminio

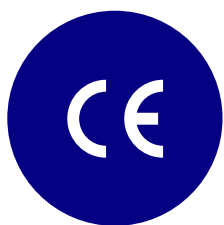



CODICE	W	lm	K	CRI	FASCIO	COLORE	MISURA
SB340	15	1500	3000	85	110	Bianco	18cm
SB341	15	1500	3000	85	110	Ottone	18cm
SB342	15	1500	3000	85	110	Titanio	18cm
SB343	25	2600	3000	85	110	Bianco	28cm
SB344	25	2600	3000	85	110	Ottone	28cm
SB345	25	2600	3000	85	110	Titanio	28cm

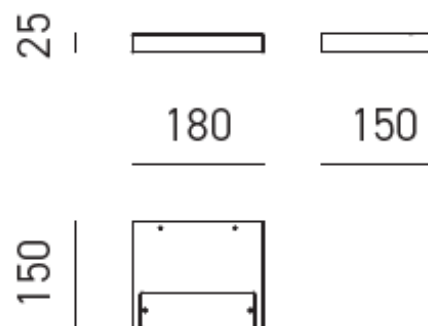
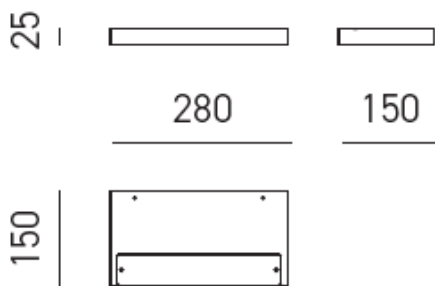

BRICK

Lampada da parete per illuminazione sopra e sotto. Disponibile in due misure, ideale per illuminare in modo generale ambienti residenziali.

Struttura in alluminio verniciato bianco.

- Illuminazione generale
- Biemissione
- Spazi residenziali
- Struttura in alluminio





CODICE	W	lm	K	CRI	FASCIO	COLORE	MISURA
SB346	16	1799	3000	85	110	Bianco	28cm
SB347	24	2600	3000	85	110	Bianco	38cm

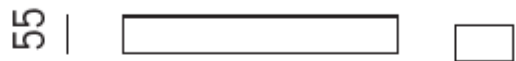
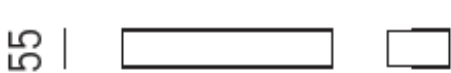
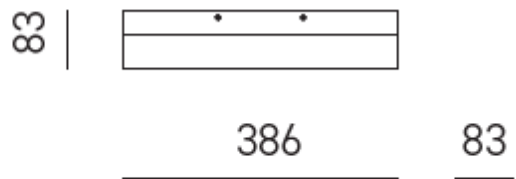
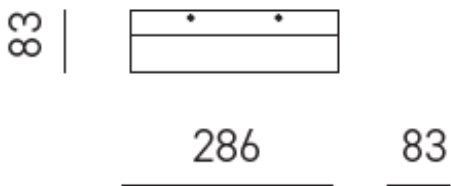

CIRCLE

Lampada da soffitto a forma di anello.
Perfetta per creare composizione con effetti straordinari.
Luce diffusa generale, ideale per illuminazione di grandi spazi.
Struttura in alluminio verniciato bianco o nero

- Illuminazione generale
- Luce diffusa
- Spazi residenziali
- Struttura in alluminio

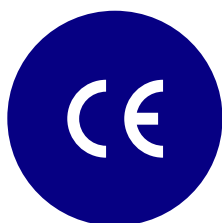



CODICE	W	lm	K	CRI	FASCIO	COLORE	MISURA
SB348	30	2300	3000	85	110	Bianco	40cm
SB349	30	2300	3000	85	110	Nero	40cm
SB350	50	3700	3000	85	110	Bianco	60cm
SB351	50	3700	3000	85	110	Nero	60cm
SB352	60	4300	3000	85	110	Bianco	80cm
SB353	60	4300	3000	85	110	Nero	80cm
SB354	80	6300	3000	85	110	Bianco	100cm
SB355	80	6300	3000	85	110	Nero	100cm

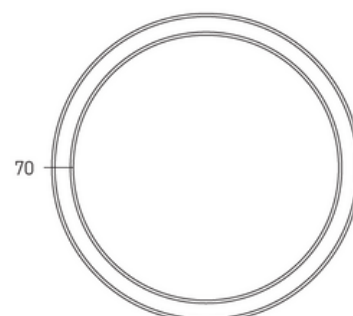
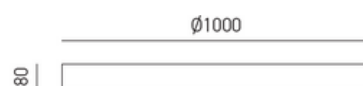
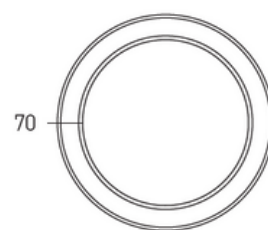
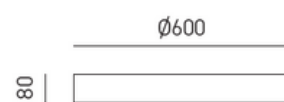
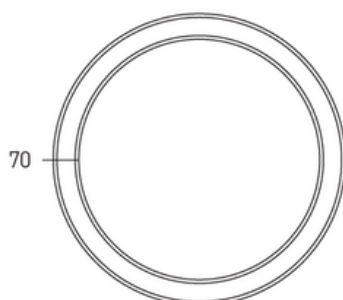
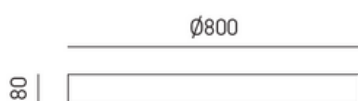
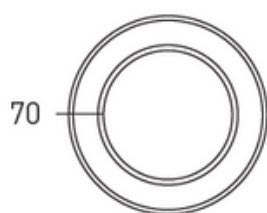
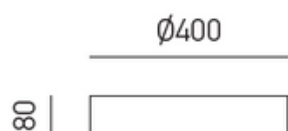



SPOT

Faretto orientabile per installazione a soffitto o parete. Struttura in alluminio verniciato bianco o nero. Perfetto per illuminare grandi zone o pareti con ottima performance luminosa.

Fascio largo, su richiesta ottica 15°

- Illuminazione generale
- Spazi residenziali e commerciali
- Ottica orientabile
- A richiesta lente 15°

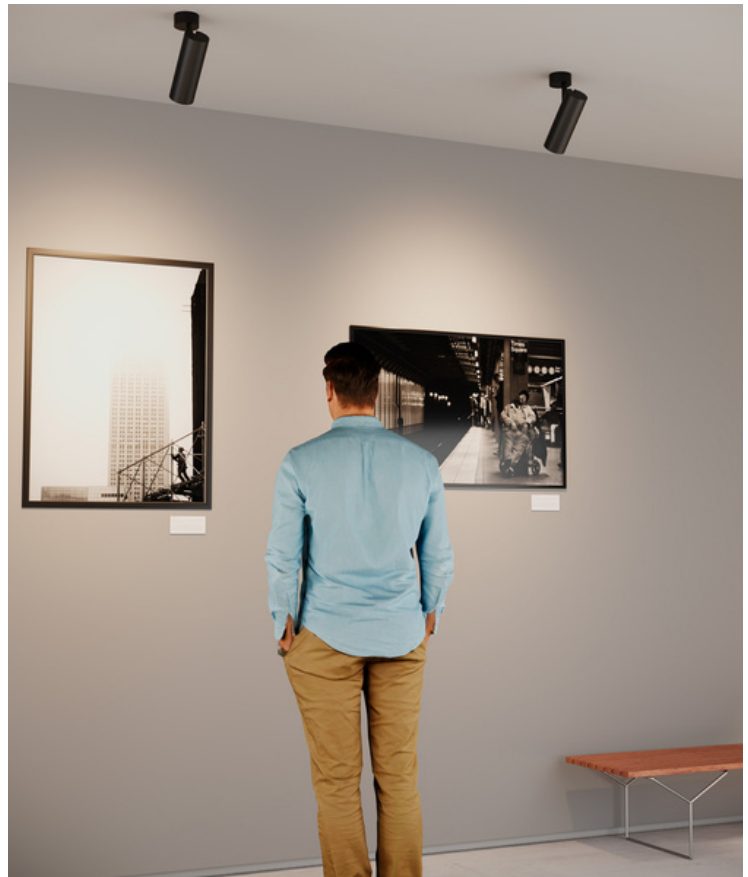



CODICE	W	lm	K	CRI	FASCIO	COLORE	MISURA
SB360	20	2200	3000	90	38	Bianco	14cm
SB361	20	2200	3000	90	38	Nero	14cm
SB362	20	2400	4000	90	38	Bianco	14cm
SB363	20	2400	4000	90	38	Nero	14cm

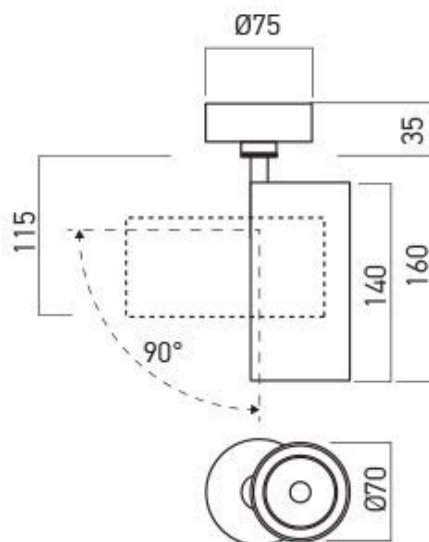

CUBO

Cubetto per installazione a parete, sia per interni che per esterni. Al suo interno ospita alette orientabili per determinare il fascio di uscita della luce. Disponibile in due diverse potenze. Struttura in alluminio

- Per interni ed esterni
- Alette orientabili per creare effetti.
- 10W e 20W
- Struttura in alluminio

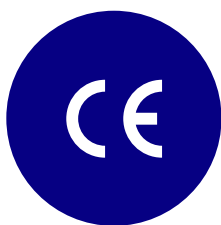

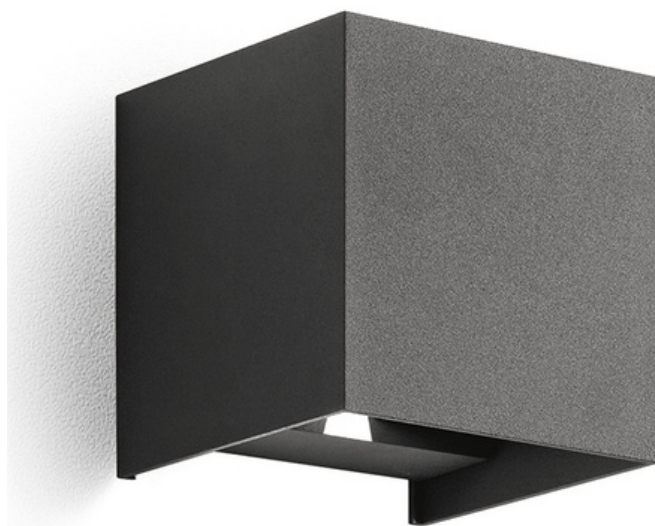

CODICE	W	lm	K	CRI	FASCIO	COLORE	MISURA
SB364	10	600	3000	85	Regolabile	Bianco	10x10cm
SB365	20	900	3000	85	Regolabile	Bianco	12x12cm
SB366	10	600	3000	85	Regolabile	Antracite	10x10cm
SB367	20	900	3000	85	Regolabile	Antracite	12x12cm
SB368	10	600	3000	85	Regolabile	Grigio	10x10cm
SB370	10	600	3000	85	Regolabile	Nero	10x10cm
SB371	20	900	3000	85	Regolabile	Nero	12x12cm

