

Ecophon Solo™ Rectangle

Solo Rectangle is een vrijhangende unit die ongekende ontwerpmogelijkheden biedt. Met drie verschillende ophangsystemen is het eenvoudig om verschillende lagen en hoeken te creëren. Geschikt als de inhoud van de ruimte gehandhaafd moet blijven of als het niet mogelijk is een wand-tot-wand plafond te installeren.



M30 Architecten, Oisterwijk, Netherlands

SYSTEEMASSORTIMENT



Afmeting, mm	1800x1200	2400x600	2400x1200	3000x1200
Product specifieke montage	•	•	•	•
Dikte (d)	40	40	40	40
Inst. schema	M404, M506	M405	M406, M407, M506	M408



Solo Rectangle

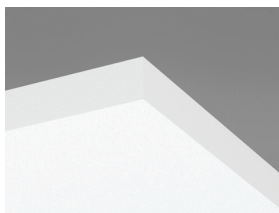

Solo paneel



Ophanging met Connect Verstelbare kabelhanger en Connect Absorber



Ophanging met Connect Absorber beugel en Connect Absorber anker



Akoestiek

De waarden in de grafiek verwijzen naar een enkel paneel. Indien de panelen in een cluster worden geplaatst met een onderlinge afstand van minder dan 0.5 m. zal de Aeq per paneel iets afnemen.

Geluidsabsorptie:

Testresultaten conform EN ISO 354.

A_{eq} gelijkwaardig absorptie oppervlakte per paneel (m² sabin)

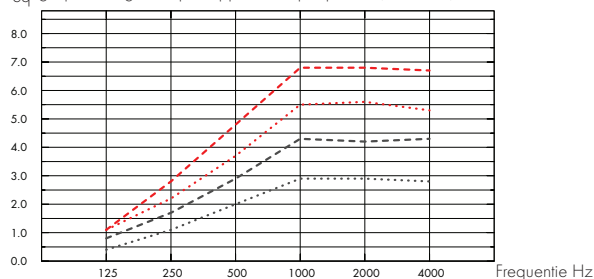

... Solo Rectangle 2400x1200, 1000 mm o.d.s.

--- Solo Rectangle 1800x1200, 1000 mm o.d.s.

... Solo Rectangle 2400x600, 1000 mm o.d.s.

-.- Solo Rectangle 3000x1200, 1000 mm o.d.s.

o.d.s = a.o.p. = afhanghoogte onderkant plafond

	d mm	a.o.p. mm	A _{eq} gelijkwaardig absorptie oppervlakte per paneel (m ² sabin)					
			125 Hz	250 Hz	500 Hz	1000 Hz	2000 Hz	4000 Hz
2400x1200	40	200	1.30	2.80	3.50	4.10	4.10	3.90
2400x1200	40	400	1.20	2.40	3.30	4.70	4.90	4.70
2400x1200	40	1000	1.10	2.20	3.70	5.50	5.60	5.30
1800x1200	40	200	0.60	2.00	2.90	3.40	3.30	3.10
1800x1200	40	400	0.80	1.90	2.60	3.70	3.70	3.60
1800x1200	40	1000	0.80	1.70	2.90	4.30	4.20	4.30
2400x600	40	200	0.50	1.40	2.00	2.40	2.30	2.30
2400x600	40	400	0.40	1.20	1.80	2.60	2.70	2.70
2400x600	40	1000	0.40	1.10	2.00	2.90	2.90	2.80
3000x1200	40	200	1.10	3.30	4.40	5.10	5.10	5.00
3000x1200	40	400	1.20	3.00	4.20	5.80	5.80	5.70
3000x1200	40	1000	1.10	2.80	4.80	6.80	6.80	6.70



Binnenluchtqualiteit

Certificaat/ Label

Finse M1

Franse VOC A+



Environmental Footprint

Kg CO₂ equiv/m²: 5,32

Van EPD conform ISO 14025 / EN 15804.



Circulariteit

Volledig recyclebaar.



Brandveiligheid

Land	Standaard	Klasse
Europe	EN 13501-1	A2-s1,d0

De kern van glaswol van de panelen is getest en geclassificeerd als niet-brandbaar conform EN ISO 1182.



Vochtbestendigheid

Klasse A, relatieve luchtvochtigheid 70% en 25°C, volgens EN 13964:2014



Visuele uitstraling

White Frost, benadert NCS kleurmonster S 0500-N, 85% lichtreflectie. Glans < 1.



Reiniging

De panelen mogen dagelijks worden afgestoft en gestofzuigd en wekelijks met een vochtige doek worden gereinigd.



Toegankelijkheid

De panelen kunnen worden gedemonteerd.



Installatie

Montage conform installatieschema, installatiehandleiding en Drawing Aid. Voor informatie over de minimale afhanghoogte van het systeem, zie materiaalspecificatie.



Mechanische eigenschappen

Het paneel kan geringe puntbelastingen en uniforme verspreide belastingen dragen. Zie Functionele eigenschappen, Mechanische eigenschappen op www.ecophon.com/nl



CE

Ecophon plafondsysteem zijn CE gemarkeerd volgens de Europese geharmoniseerde norm EN13964:2014. Bouwmaterialen met CE markering worden ondersteund door een Declaration of Performance (DOP) die de gebruikers in staat stellen om de prestaties van beschikbare producten op de Europese markt te vergelijken.

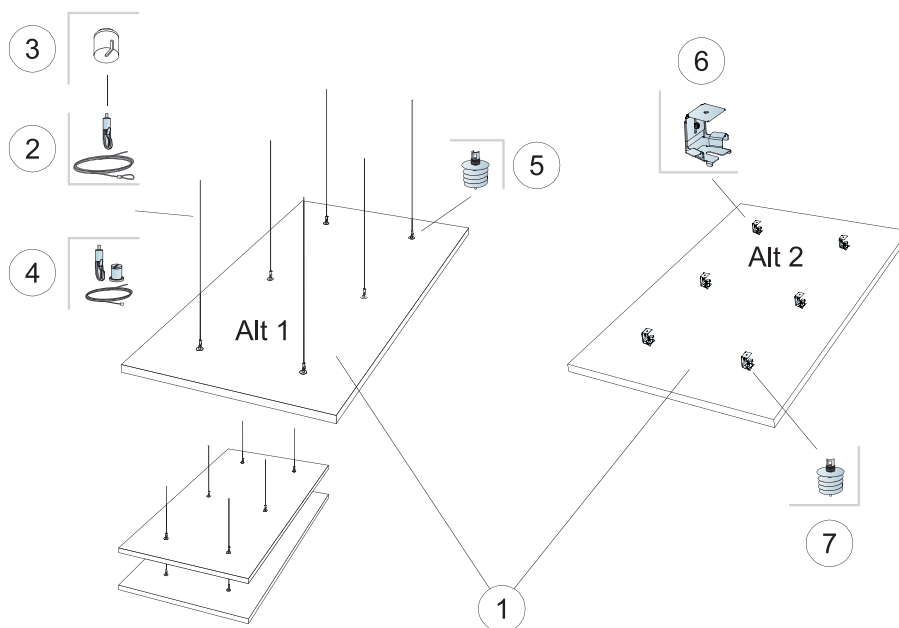

MATERIAALSPECIFICATIE (EXCLUSIEF AFVAL)

		Afmeting, mm
		1800x1200
1	Solo Rectangle	2,16m ² /paneel
2	Connect Verstelbare kabelhanger (Alt 1)	6/paneel
3	Connect Plafondkapje (Alt 1, optioneel)	6/paneel
4	Connect Verstelbare Kabelkit (Alt 1, optioneel)	6/paneel
5	Connect Absorber anker (Alt 1)	6/paneel
6	Connect Absorber beugel (Alt 2)	6/paneel
7	Connect Absorber anker (Alt 2)	6/paneel

Δ Min. afhanghoogte onderkant plafond: Δ1 140 mm / Δ2 90 mm

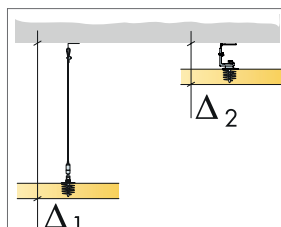

Zie materiaalspecificatie

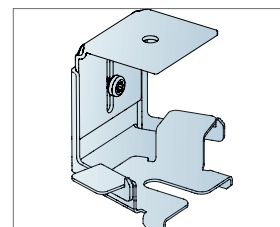
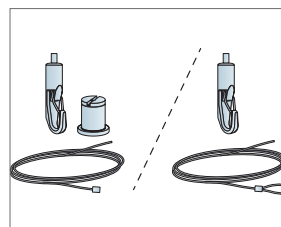
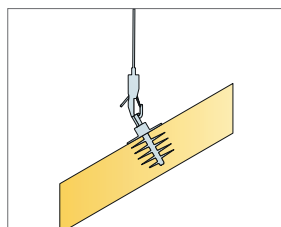

Detail van Absorber beugel. Afhanghoogte onderkant plafond tussen 90-130 mm

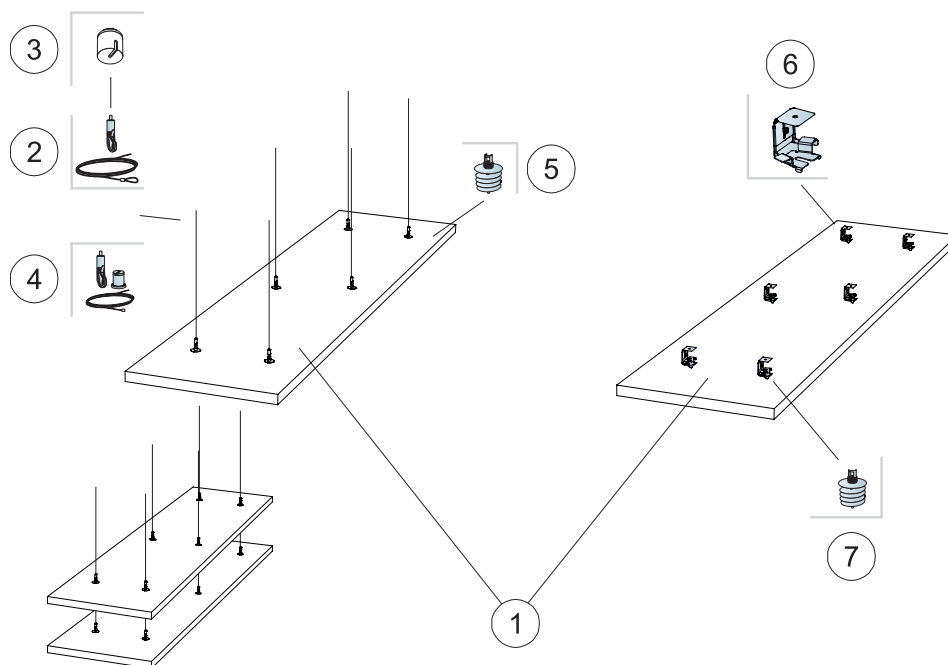

MATERIAALSPECIFICATIE (EXCLUSIEF AFVAL)

		Afmeting, mm
		2400x600
1	Solo Rectangle	1,44m ² /paneel
2	Connect Verstelbare kabelhanger (Alt 1)	6/paneel
3	Connect Plafondkapje (Alt 1, optioneel)	6/paneel
4	Connect Verstelbare Kabelkit (Alt 1, optioneel)	6/paneel
5	Connect Absorber anker (Alt 1)	6/paneel
6	Connect Absorber beugel (Alt 2)	6/paneel
7	Connect Absorber anker (Alt 2)	6/paneel

Δ Min. afhanghoogte onderkant plafond: Δ1 140 mm / Δ2 90 mm

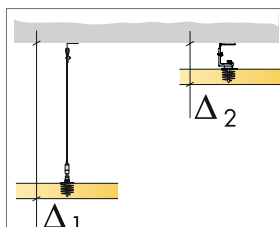

Zie materiaalspecificatie

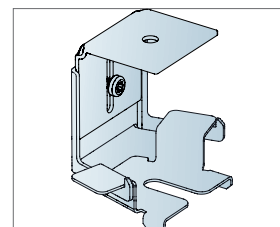
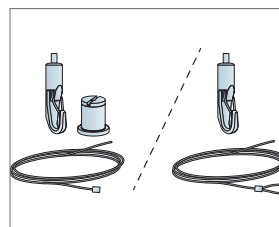
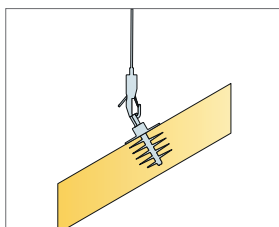

Detail van Absorber beugel. Afhanghoogte onderkant plafond tussen 90-130 mm

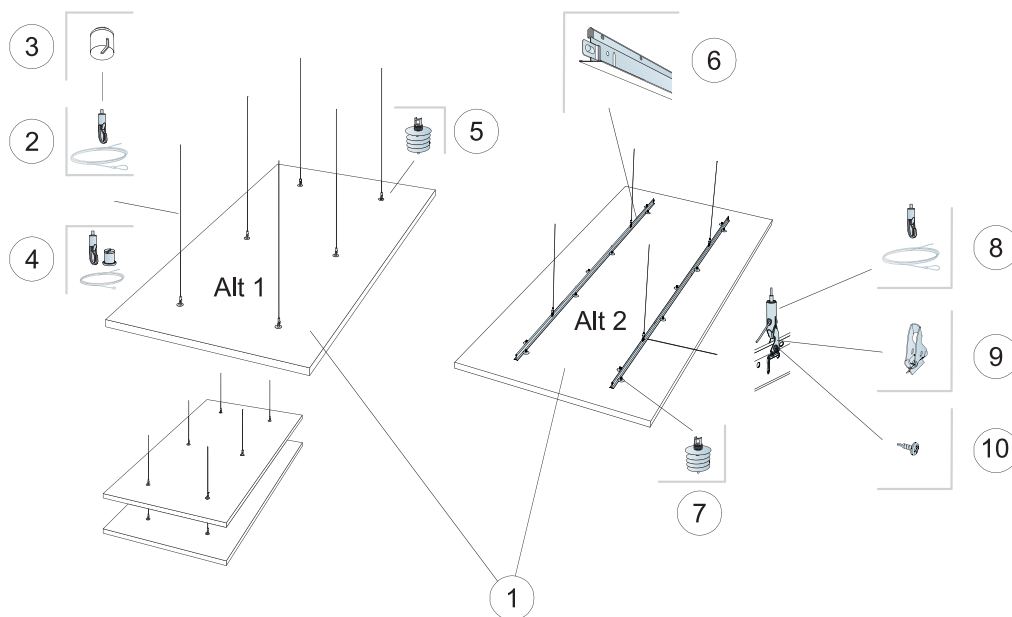

MATERIAALSPECIFICATIE (EXCLUSIEF AFVAL)

	Afmeting, mm
	2400x1200
1 Solo Rectangle	2,88m ² /paneel
2 Connect Verstelbare kabelhanger (Alt 1)	6/paneel
3 Connect Plafondkapje (Alt 1, optioneel)	6/paneel
4 Connect Verstelbare Kabelkit (Alt 1, optioneel)	6/paneel
5 Connect Absorber anker (Alt 1)	6/paneel
6 Connect T24 Hoofdprofiel (Alt 2)	2/paneel
7 Connect Absorber anker (Alt 2)	14/paneel
8 Connect Verstelbare kabelhanger (Alt 2)	4/paneel
9 Connect Hanger Clip (Alt 2)	4/paneel
10 Connect Montageschroef MVL (Alt 2)	4/paneel

Δ Min. afhanghoogte onderkant plafond: Δ1 140 mm / Δ2 200 mm

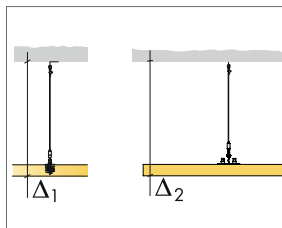

Zie materiaalspecificatie

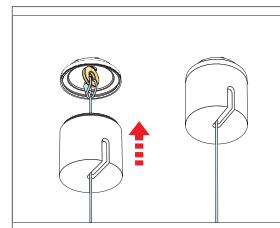
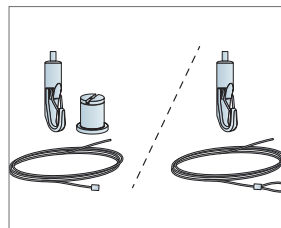
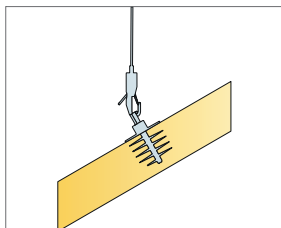

Installatie van Connect Plafondkapje

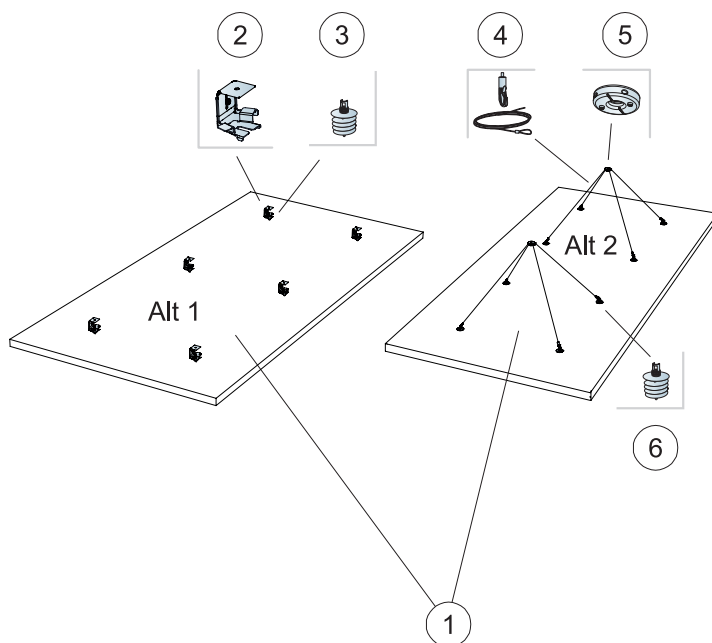

MATERIAALSPECIFICATIE (EXCLUSIEF AFVAL)

		Afmeting, mm
		2400x1200
1	Solo Rectangle voor M407	2,88m ² /paneel
2	Connect Absorber beugel (Alt 1)	6/paneel
3	Connect Absorber anker (Alt 1)	6/paneel
4	Connect Verstelbare kabelhanger (Alt 2)	4/paneel
5	Connect Eén-punts bevestiging (Alt 2)	2/paneel
6	Connect Absorber anker (Alt 2)	8/paneel

Δ Min. afhanghoogte onderkant plafond: Δ1 90 mm / Δ2 500 mm

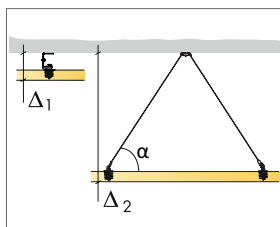

Zie materiaalspecificatie

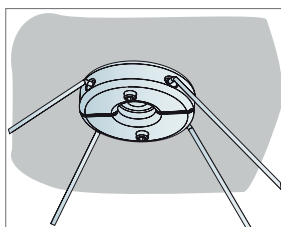

Detail Eén-punts bevestiging

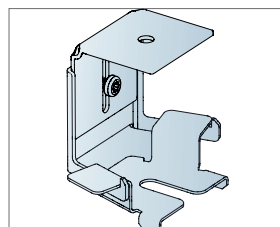

Detail van Absorber beugel. Afhanghoogte onderkant plafond tussen 90-130 mm



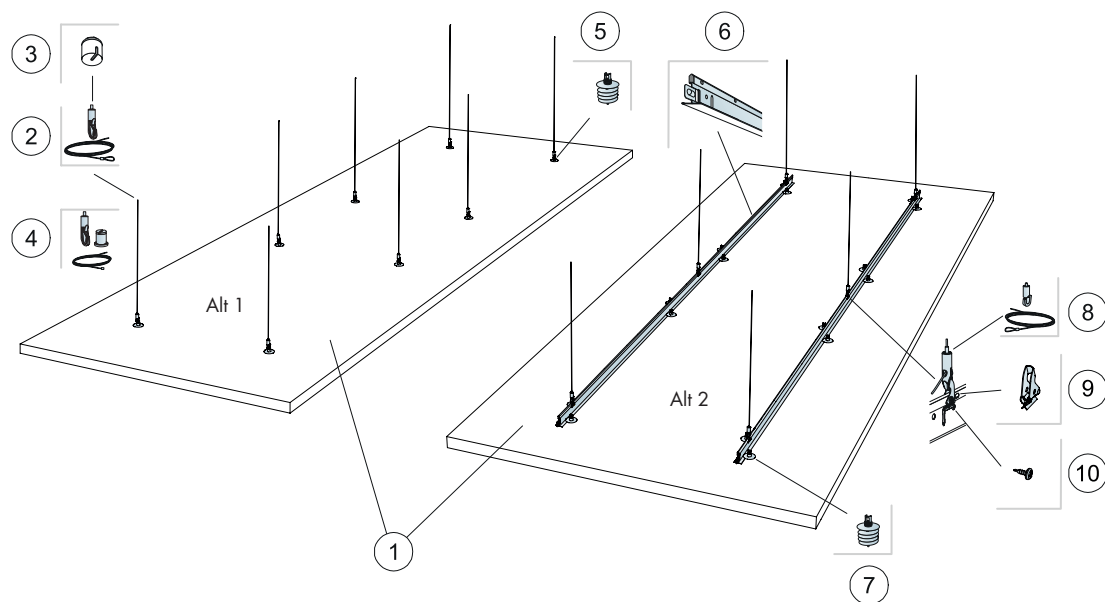

MATERIAALSPECIFICATIE (EXCLUSIEF AFVAL)

		Afmeting, mm
		3000x1200
1	Solo Rectangle	3,6m ² /paneel
2	Connect Verstelbare kabelhanger (Alt 1)	8/paneel
3	Connect Plafondkapje (Alt 1, optioneel)	8/paneel
4	Connect Verstelbare Kabelkit (Alt 1, optioneel)	8/paneel
5	Connect Absorber anker (Alt 1)	8/paneel
6	Connect T24 Hoofdprofiel (Alt 2)	2/paneel
7	Connect Absorber anker (Alt 2)	16/paneel
8	Connect Verstelbare kabelhanger (Alt 2)	6/paneel
9	Connect Hanger Clip (Alt 2)	6/paneel
10	Connect Montageschroef BR (Alt 2)	6/paneel

Δ Min. afhanghoogte onderkant plafond: Δ1 140 mm / Δ2 200 mm

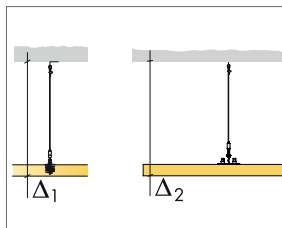

Zie materiaalspecificatie

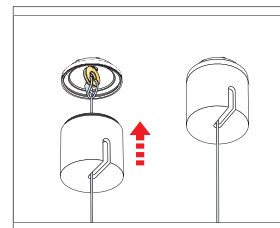
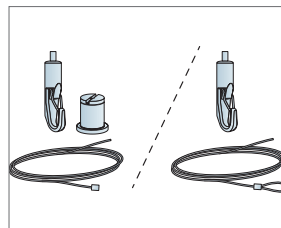
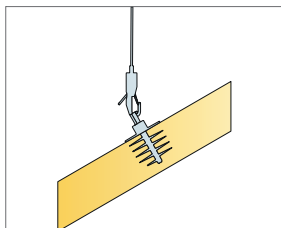

Installatie van Connect Plafondkapje

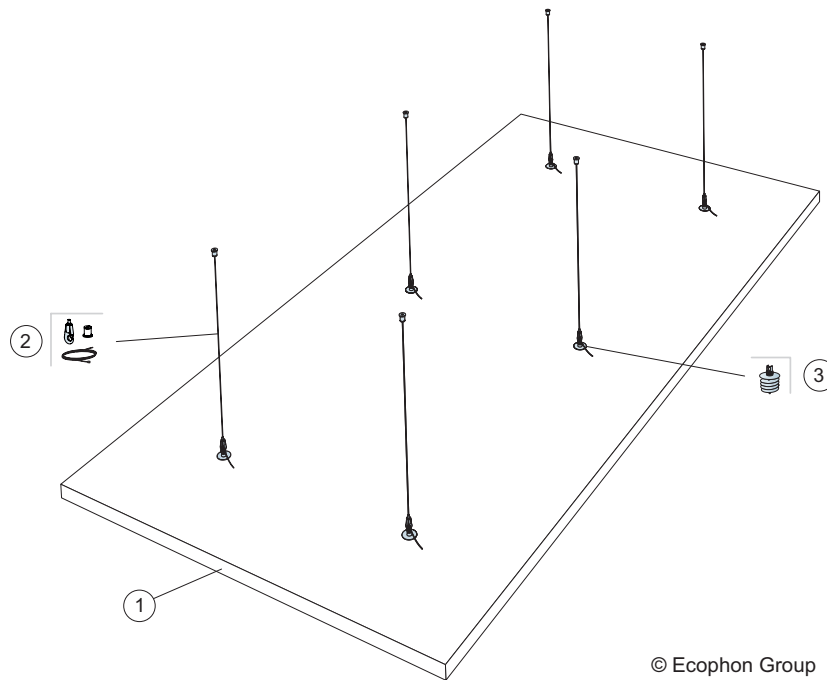

© Ecophon Group

MATERIAALSPECIFICATIE (EXCLUSIEF AFVAL)

1 null

2 null

3 null

Δ Min. afhanghoogte onderkant plafond: Δ1 140 mm / Δ2 500 mm / Δ3 121 mm

Gebruik Connect Absorber Anker Bit om Connect Absorber Anker te bevestigen.

