



# WIKI CATALOGUE

A QUICK LOOK AT OUR LABORATORY INSTRUMENTS FOR RUBBER AND PLASTIC TESTING

**gibitre**  
INSTRUMENTS



# INDEX

INSTRUMENT	Page
Gibitre Instruments	5
Gibitre Programs: a complete solution for your lab	6
Datagest Software	7
RHEOCHECK MD - Drive	8
Rheocheck Profile OD - PC	9
Mooney Check - Drive	10
Constant Volume Sample Cutter	11
Tackiness Check - PC	12
Tensor Check Profile - PC	13
Density Check - PC	14
Low Temperature Check	15
Ozone Check - UV	16
Automatic Hardness Check	17
Multi-Unit Automatic Hardness Check	18
Micro-IRHD Laser Revolution	19
Manual Digital Hardness Check	20
ACCREDIA Calibration Service	21
Certified Samples	22
Rebound Check	23
De Mattia Fatigue Check	24
De Mattia Fatigue Check - Plus	25
Abrasion Check	26
Hose Abrasion Check	27
Block Oven Aging Check	28
Compression Set - Constant Force	29
Compression Set - Standard	29
Compression Set - PV 3307	30
Compression Set - PV 3330	30
Compression Set - Adjustable	31
Flammability Check	32
Laboratory Press	33
Multi-Head Die Cutter	34
Die Cutters	35
Splitting Machine	36
Maintenance and Calibration Service	37
Remote assistance Service using Team Viewer Software	37
Custom Setups	38



# GIBITRE INSTRUMENTS

DEVELOPMENT, PRODUCTION AND CALIBRATION OF INSTRUMENTS FOR RUBBER AND PLASTIC TESTING



**ACCREDIA**   
L'ENTE ITALIANO DI ACCREDITAMENTO

**LAT N° 182**

**Signatory of EA, IAF and ILAC Mutual Recognition Agreements**

**Membro degli accordi di Mutuo Riconoscimento EA, IAF e ILAC**



Gibitre Instruments is an Italian company founded in 1979 and is dedicated to the production of measuring instruments for measuring the physical-mechanical properties of rubber and plastic.

The company deals with the entire production cycle: mechanical design, software development, component mechanical processing, assembly, testing and calibration, installation, periodic maintenance and calibration.

### Mechanical workings

The mechanical workshop of Gibitre is equipped with modern CNC machines that allow to realize almost all the mechanical components present in the instruments.

### Management of components

The storage of all production and purchase components is carried out by rotating warehouses to ensure complete traceability of the components and to optimize the shipping times of spare parts

### ISO 17025 Accreditation

Gibitre Instruments is Official Accredia Calibration Laboratory for the calibration of Shore and Ird durometers since 2005. Accredited calibrations are carried out in the metrology room with controlled temperatures and humidities.

### Standard Calibration Service

Gibitre Instruments supplies, directly or through authorized agencies, maintenance and calibration services for all the instruments it

produces.

All the calibrations carried out have complete traceability to the reference instruments. The Calibration Reports allow the customer to go back to the entire traceability chain and include the calculation of the uncertainty related to each measurement performed.

### Technical Assistance and Remote Assistance

Gibitre provides telephone support and remote assistance services for all customers.

### The demonstration hall

The Gibitre Instruments office is equipped with a demonstration hall and training rooms. These structures are used for demonstrative tests related to the functionality of the instruments, tests and for the training of technicians.

# QUICK CHOICE

## RHEOLOGY



Rheocheck MD - Drive  
page 8



RheoCheck OD - Profile  
page 9



Mooneycheck - Drive  
page 10



Constant Volume sample cutter  
page 11

## PHYSICAL TESTING



Tackiness Check  
page 12



Tensor Check  
page 13



Density Check - PC  
page 14



Rebound Check  
page 23

## HARDNESS TESTING



Automatic Hardness Check  
page 17



Multi-Unit Hardness Check  
page 18



Micro-IRHD Laser Revolution  
page 19



Manual Digital Hardness Check  
page 20



LAT N° 182

Signatory of EA, IAF and ILAC  
Mutual Recognition Agreements

Membro degli accordi di Mutuo  
Riconoscimento EA, IAF e ILAC

ISO 17025 Calibration  
page 21

**AGEING CHARACTERISTICS**



**Ozone Check - UV**  
page 16



**Block Oven Aging Check**  
page 28



**Flammability Check**  
page 32

**APPLICATIVE CHARACTERISTICS**



**Low Temperature Check**  
page 15

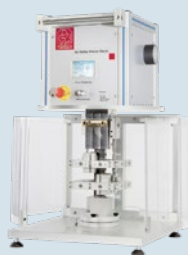

**De Mattia Fatigue Check**  
page 24



**De Mattia Fatigue Check - Plus**  
page 25



**Abrasion Check**  
page 26



**Hose Abrasion Check**  
page 27

**SAMPLE PREPARATION**



**Laboratory Press**  
page 33



**Multi-Head Die Cutter**  
page 34



**Cutters**  
page 35



**Splitting Machine**  
page 36



# GIBITRE PROGRAMS: A COMPLETE SOLUTION FOR YOUR LAB

A COMPLETE PACKAGE OF SOFTWARE PRODUCTS FOR MAKING TESTING ACTIVITY AND STORAGE OF EASY AND EFFICIENT

Gibitre has developed a family of software products for the use of pc-controlled instruments. The programs are developed directly by Gibitre and have common features to make it easy to use and learn.

The programs are connected to the **standard Gibitre SQL database**. The Test results and test curves produced with any Gibitre instrument are automatically stored in the Database at the end of the test and available using Datagest program.

The programs are fully **compatible with Windows 7, 8 or 10** operating systems.

The connection between the instruments and standard PC is made using the USB cable supplied with each instrument. Instruments connected to the same PC can be used simul-

aneously.

**Test identification** is quick and simple: you can enter it manually or using a bar-code reader.

### Test Procedures

The Standard Gibitre SQL database includes a big range of test procedures for each instrument, which permit to automatically set the instruments and calculate results according to international standards.

The test procedures can be easily prepared, copied and edited to fit your needs

**Tolerance limits** for each Product, Customer and Testing Procedure can be entered manually or calculated automatically using statistic analysis.

The check of the conformity of the test results with the limits is made automatically at the end

of each test.

### Statistics

The programs automatically calculate: Max, Min, Mean, Median, St. Deviation, Cp, Cpk and plot X-Chart and the Gaussian curve of the results.

**The test reports** may include: test identification. (Order, Lot, Batch, Product, Customer, Date, Operator), Test procedure, Results, Tolerance limits, Test curves (with different colors), Statistic analysis, Notes, Digital Signature of the operator, Company logo.

Gibitre programs are multi-language.

**Available languages** are: Italian, English, German, French, Portuguese, Russian, Chinese, Japanese, Turkish, Polish, Czech



# DATAGEST SOFTWARE

THE SOFTWARE FOR DATA MANAGEMENT IS PROVIDED IN COMBINATION WITH GIBITRE PROGRAMS AND PERMITS THE MANAGEMENT OF TEST RESULTS, STATISTICS, TOLERANCE LIMITS, CUSTOMERS, PRODUCTS, AGEING TREATMENTS

## Overview

The Datagest program is the database management tool always installed in combination with all Gibitre instrument-control programs. The program permits to:

- Select, filter, print, export and analyze the test results stored with all the instruments connected.
- Prepare test procedures by defining the test conditions and the results to be produced.
- Set tolerance limits for each product by

manual insertion or using the statistical analysis (mean and standard deviation) of saved results.

- Prepare multi-instrument test reports.

### Gibitre Standard SQL Database

All the Gibitre programs use store test results into Gibitre Standard SQL database.

The database can be installed into an existing SQL instance present on your company server. Alternatively an SQL engine (Express Version) is installed together with the programs.

**Gibitre - Company Connect program** is a configurable synchronization tool specifically developed to permit the easy synchronization of information available in your Company management system and Gibitre SQL Standard database.

The synchronization of data permits to ensure traceability of results, prevent typing errors and enter test identification for all the instruments connected using a bar-code readers.

The screenshot displays the 'Gibitre Instruments srl - Database' application window. The main area shows a table with columns for Status, Order, Lot, Batch, Sample, Test Date, Test Hour, Instrument, Procedure, Product, Product Code, Customer, Customer Code, Job, Operator, and Machine Code. Below the table, there is a 'Filter is Empty' message and a 'Graph' section showing a plot of 'Points' versus 'min' with a curve and various axes settings.



IN:  
Company database

OUT:  
Statistic analysis

OUT:  
Test reports

OUT:  
Data export

# RHEOCHECK MD - DRIVE

MOVING DIE RHEOMETER CONTROLLED BY  
PERSONAL COMPUTER.

STANDARDS: ASTM D5289; ISO 6502-1; ISO 6502-3;



Gibitre MD Rheometer measures the cure characteristics of a rubber compound in conformity with the international standards.

The measure of the vulcanization is carried out by measuring the modification in the mechanical characteristics of the sample. The instrument permits to apply a cyclic strain to a test piece and to measure the associated force. The test is performed at a defined temperature and the measure of stiffness recorded continuously as a function of time.

### Key Features

- Biconical, closed die system, sealed testing chamber
- Top brand Torque sensor positioned in the upper test chamber
- Exclusive construction for the micrometric adjustment of the gap between the dies
- Independent PID temperature controllers with 0.1°C resolution
- Compressed air cooling circuit for rapid temperature reduction

- Touch-screen display for instrument control
- Full license of Rheocheck\_10 software optimized for Bar-code sample identification
- Full license of Datagest\_10 software for complete management of Gibitre SQL Database

### Accessories

- Automatic sample loader.
- Pressure sensor for testing of cellular rubber.
- Constant Volume Sample Cutter.

**Numerical Test Data:** Torque Values: MI, ML, M90, MX, MH, PCR S°@ML, S°@MH, TanDeML, TanDeMH. Scorch Time: tS1, tS2, tSX. Cure Time: t90, tX, tML, tMH, tPCR, tRX, CRI; Pressure: PL, PH, tP, MPR, tMPR

**Displayed Curves:** Elastic (S'), Viscose (S''), Complex (S\*), Tan-Delta, storage shear Modulus (G'), loss shear Modulus (G''), Curing speed, Dies Temperatures

**Torque sensor:** Brand: Interface®; Capacity: 20 N\*m; Resolution: 0.01 dN\*m; Linearity Error (%FS): +-0.25

**Oscillation frequency:** 100 cycles/minute (1,7 ± 0,1 Hz)

**Oscillation angle:** 0.5°, 1°. Easy adjustment with calibrated gauges

**Temperature:** between room temperature and +250 °C - Resolution 0.1 °C

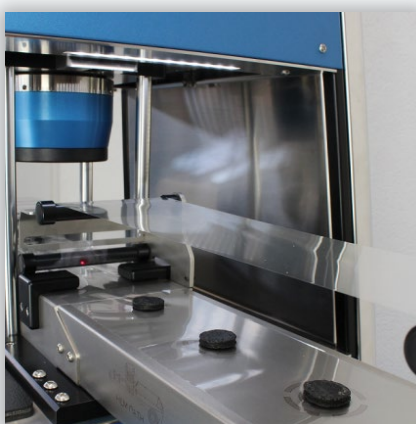
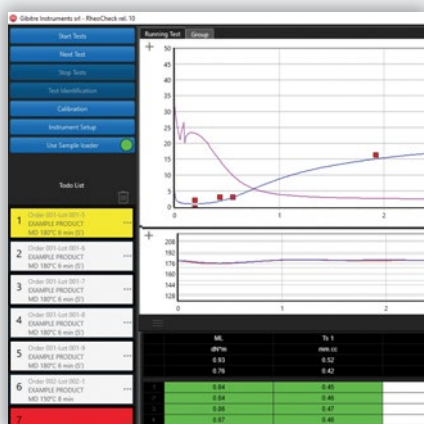



# RHEOCHECK PROFILE OD - PC

OSCILLATING DISK RHEOMETERS CONTROLLED BY  
PERSONAL COMPUTER.

STANDARDS: ASTM D2084; ISO 6502-1; ISO 6502-2;



**gibitre**  
INSTRUMENTS

Gibitre OD Rheometer measures the cure characteristics of a rubber compound in conformity with the international standards. The measure of the vulcanization is carried out by measuring the modification in the mechanical characteristics of the sample. The instrument permits to apply a cyclic strain to a test piece and to measure the associated force. The test is performed at a defined temperature and the measure of stiffness recorded continuously as a function of time.

### Key Features

- Test chamber in compliance with international standards
- Independent PID temperature controllers with 0.1°C resolution
- Easily accessible test chamber with transparent safety panel and safety lock
- Pneumatic Rotor ejection and clamping systems
- Easy-to-change rotor oscillation amplitude
- Full license of Rheocheck\_10 software opti-

mized for Bar-code sample identification

- Full license of Datagest\_10 software for complete management of Gibitre SQL Database

### Accessories

- Volumetric die cutter.
- Dies for OD rheometer with two Ø 8mm moulds.
- Pressure sensor integrated in the upper die with 0.1 bar resolution.

**Numerical Test Data (for each test procedure up to 20 test results can be selected):** Torque Values: MI, ML, M90, MX, MH, PCR, S<sup>o</sup>@ML, TanDe ML, S<sup>o</sup>@MH, TanDe@MH (X=customer-defined); Scorch Time: tS1, tS2, tSX ; Cure Time: t90, tX, tML, tMH, tPCR, tRX; Pressure (optional) PL, PH, tP, MPR, tMPR

**Graphic representation:** Elastic curve (S'), Viscose curve (S''), Complex

curve (S'')Tan-Delta curve, Curing speed, Upper and Lower test chamber temperatures

**Oscillation frequency:** 100 cycles /minute (1,7 ±0,1 Hz)

**Oscillation Angle:** 1°, 3°

**Temperature:** 50 ÷ 230 °C - Resolution 0.1 °C

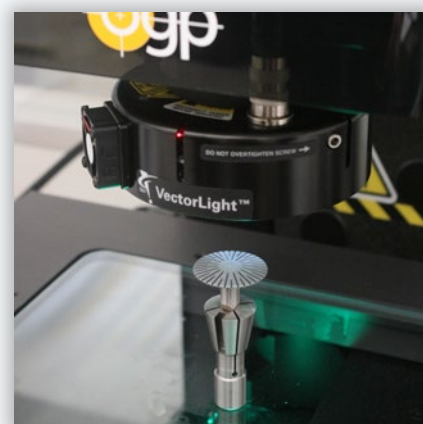

# MOONEY CHECK - DRIVE

**MOONEY VISCOMETER CONTROLLED BY PERSONAL COMPUTER.**

STANDARDS: ASTM D1646; ISO 289-1; ISO 289-2; ISO 289-4;



The Mooney viscometer is a shearing-disc viscometer, which permits to measure the Mooney viscosity, Pre-curing (scorch) and Stress Relaxation Characteristics of uncompounded or compounded rubbers.

The test is carried out by measuring the torque, which has to be applied under specified temperature and pressure conditions, in order to rotate a metal disc at 2rpm speed in the cylindrical test chamber filled with rubber. The resistance offered by the rubber to this rotation is expressed as the Mooney viscosity of the

test piece.

### Key Features

- Performance of Viscosity, Scorch and Stress Relaxation tests
- Test chamber and rotor in compliance with international standards
- Touch-screen display for instrument control
- Independent PID temperature controllers with 0.1°C resolution
- Calibrated internal Weight for auto-calibration
- Pneumatic rotor expulsion system

- Easily accessible test chamber with transparent safety panel and safety lock
- Full license of Mooneycheck\_10 software optimized for Bar-code sample identification
- Full license of Datagest\_10 software for complete management of Gibitre SQL Database

### Accessories

- Volumetric die cutter.
- Polyamide or Polyester Film for the protection of the dies during the test.

**Numerical test data (for each test procedure up to 20 test results can be selected):** Viscosity test :MU\_ini, t\_ini, MU\_min, t\_min, Dt\_MU, MU\_4, MU\_X, Dt(X-Y), S4, SX (X,Y=customer def); Scorch test :ts5, ts35, Dt\_35-5, ts3, ts18, Dt\_18-3, tsX, Dt\_X-Y ; Stress relaxation test: a, k, r, A, TX%

**Test curves produced during test time:** Torque versus time curve, ; Log Mooney versus Log time of Stress Relaxation test, ; Upper and Lower Test Chamber temperatures

**Frequency of rotation:** 2 RPM

**Temperature:** from 50 °C to 200 °C; Resolution 0.1°C

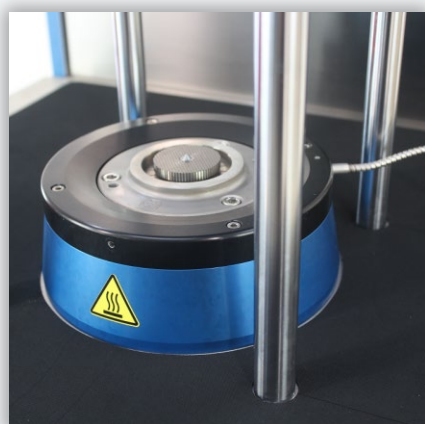

# CONSTANT VOLUME SAMPLE CUTTER

VOLUMETRIC DIE CUTTER FOR THE PREPARATION OF SAMPLES FOR MD RHEOMETER, OD RHEOMETER AND MOONEY VISCOMETER



Pneumatic cutter for the preparation of constant-volume samples for MD Rheometer, OD Rheometer and Mooney Viscometer from polymer or green rubber compounds. The solid construction of the machine and the double-piston system permit to obtain constant volume samples even with hard and high viscosity compounds.

By using samples with constant volume for your rheology tests you will increase test repeatability ensuring correct filling of test chamber.

### Key Features

- Exclusive adjustment system, which permits to set the machine to obtain samples for:
  - Moving Die Rheometer

- Oscillating Disk Rheometer
- Mooney Viscometer
- Puncher for obtaining the central hole in the lower sample for the Mooney viscosity test
- Pneumatically-activated safety panel
- CE Labelling

**Samples obtainable:** Moving Die Rheometer (MD): 5.1 cm<sup>3</sup>; Oscillating Disk Rheometer (OD): 8.1 cm<sup>3</sup>; Mooney Viscometer: 11.5 cm<sup>3</sup>

**Force produced:** 1200 Kg (at six bar air pressure)

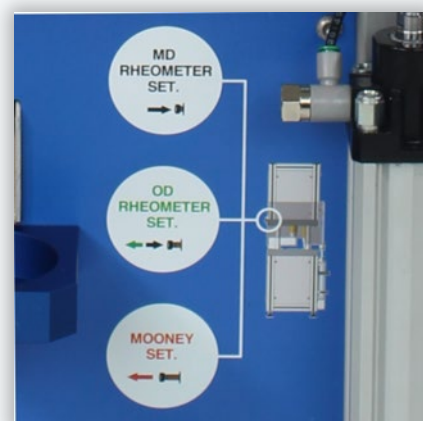
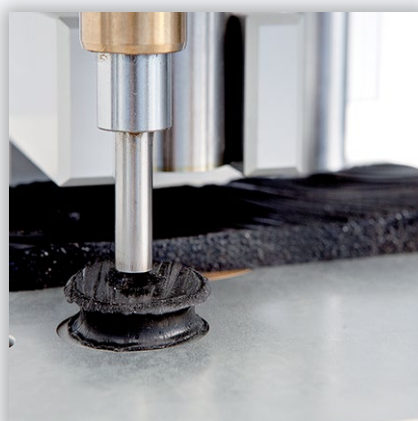
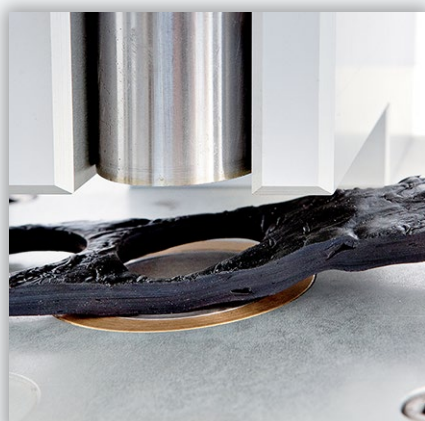

# TACKINESS CHECK - PC

**AUTOMATIC INSTRUMENT FOR THE MEASURE OF THE TACKINESS**

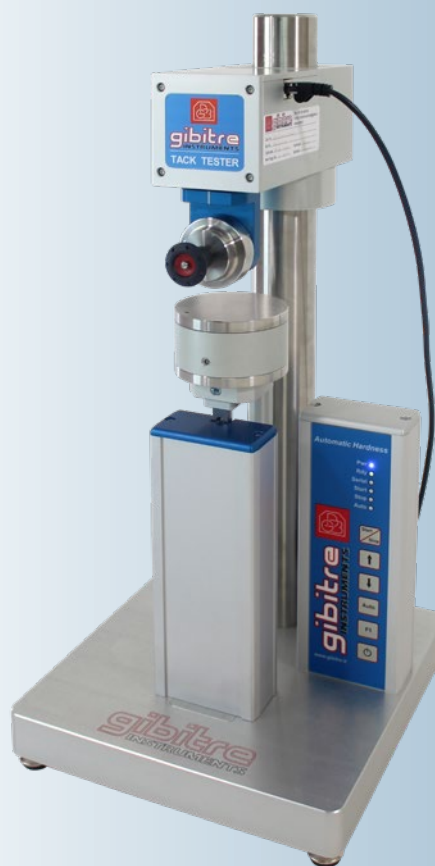

The Tackiness Check instrument measures the adhesion or tack of rubber materials, adhesive tapes, sealants and other materials. Tack is defined as the force required to separate two sheet materials which are compressed together for a specified time. The factors which influence the behavior of tack are: contact pressure, contact time and temperature. The instrument produced by Gibitre permits to set the test

cycle and allows accurate control of adhesion force and time.

**Key Features**

- Motor controlled screw with recycling of ball-bearing for the displacement of the sample (max speed 85 mm/min, stroke 50 mm)
- Displacement transducer with 0,0001 mm resolution
- Load cell for the measure of the force (Max

load 25 N, Resolution 0,0001 N)

- Interchangeable indenter for the application of the force
- Full license of Gibitre FORCE-DISPLACEMENT software optimized for Bar-code sample identification
- Full license of Datagest\_10 software for complete management of Gibitre SQL Database

**Test Cycle:** Customer-defined test cycle with adjustable force-time application

**Load Cell:** Max load: 50 N, Resolution: 0.001 N

**Sample Displacement:** Motor controlled screw with ball-screw system.

Max speed: 85 mm/min. Stroke: 50 mm. Resolution: 0.0001 mm

**Tool for the application of the force:** Interchangeable indenter, designed for easy preparation and cleaning of the contact surface

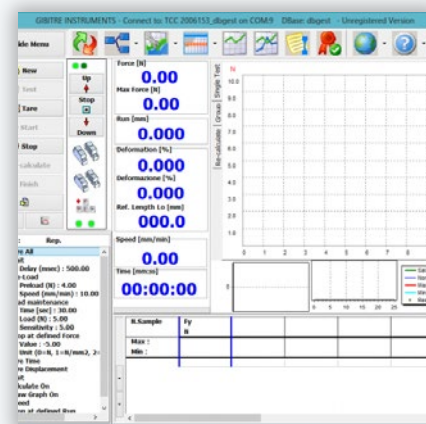
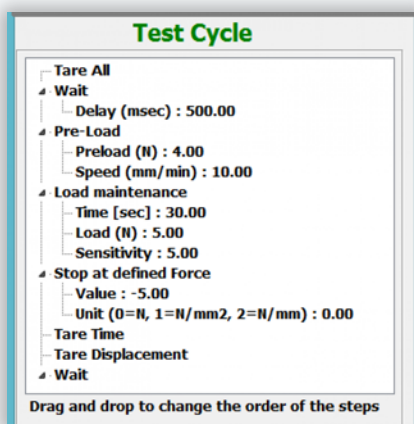
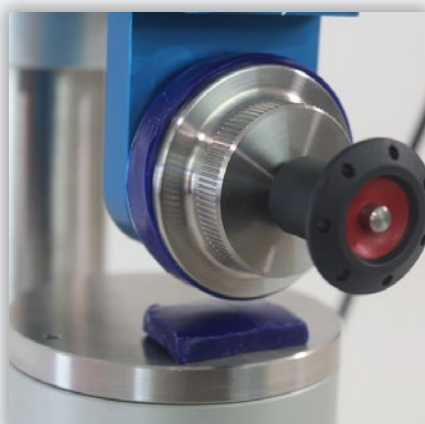

# TENSOR CHECK PROFILE - PC

FULLY PROGRAMMABLE TENSILE-TESTING SYSTEM  
WORKING IN TRACTION AND COMPRESSION  
SUITABLE FOR TESTING MECHANICAL  
CHARACTERISTICS OF MATERIALS LIKE RUBBERS,  
PLASTICS, COMPOSITES, ADHESIVES, LEATHER,  
ETC.

STANDARDS: ASTM D412; ASTM D575; ASTM D624; ASTM D638;  
ASTM D790; ASTM D882; ASTM F152; ASTM D1056; ASTM D1414;  
ASTM D1456; ASTM D1894; ASTM D2412; ASTM D3574; ATE  
N\_553\_59\_25; FIAT 50405; FIAT 50409; FIAT 50412; ISO 36; ISO  
37; ISO 178; ISO 604; ISO 814; ISO 1798; ISO 1827; ISO 2411; ISO  
34-1; ISO 5600; ISO 5893; ISO 6133; ISO 7743; ISO 8033; ISO  
8295; ISO 10319; ISO 12236; ISO 15113; ISO 527-1; ISO 527-2; ISO  
527-3; ISO 527-4; ISO 527-5; ISO 3384-1; ISO 6259-3; ISO 6916-  
1; PV 3973; UNI-EN 1372; UNI-EN 12228;

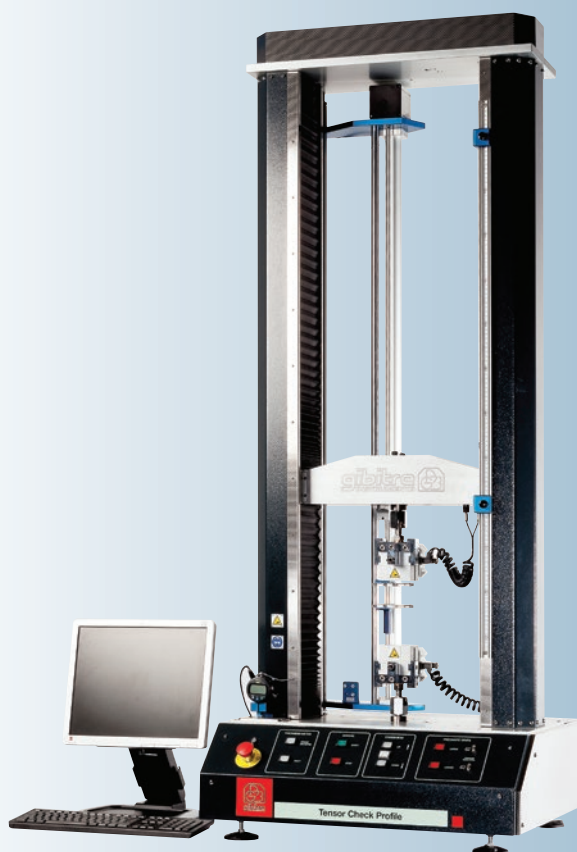

Tensor Check is a fully programmable tensile-testing system with double screw structure for testing in traction and compression up to 20 kN. The instrument permits to perform traction, compression, hysteresis, peeling, flexural and shear tests.

### Applicable Devices

- Mechanical extensometer: 0.01 mm accuracy
- Micro extensometer: 0.0001 mm resolution
- Thickness meter integrated with the software for direct sample thickness acquisition

- Environmental Chamber with Cooling Refrigerator (-40 to 250°C) and internal extensometer

- Wide range of pneumatic and manual grips for Traction, Compression, Peeling, Friction, Bending, O-ring traction, Adhesion and more

### Software

The instrument is supplied with full license of TensorCheck\_9 and full license of Datagest\_10 software. Features:

- Wide range of pre-installed test procedures

in compliance with international standards

- Step-by-step wizard procedure for the preparation of fully customized test methods
- Data acquisition from thickness meter and automatic calculation of sample cross-section
- Direct control of the thermal cycle of the environmental chamber
- Comparison of results with tolerance limits and statistic analysis
- Storage of data and curves in standard Gibitre SQL database.

**Load Transducers:** Mode: traction and compression; Base Scale: up to 20 kN; Accuracy: Class 05 (ISO 7500-1) from 1% of Scale Base ; Resolution: Scale Base/50000.; Automatic detection of the cell installed

**Mechanical Extensometer:** Resolution: 0.01 mm ; Accuracy: Class E according to ISO 5893

**Micro-Extensometer:** Resolution: 0.0001 mm ; Total Run: 3 mm

**Crosshead displacement:** Reading Resolution: 0.0025 mm; Speed: 0.2

to 1000 mm/min; Stroke: 1244 mm (without grips)

**Direct Thickness acquisition:** Thickness meter in compliance with ISO 23529 and ASTM D3767 standards. The cross sectional area is calculated according to the kind of sample selected.

**Environmental Chamber:** Temperature: between -40°C and +250°C

**Environmental Chamber:** Cooling system: Refrigeration Unit

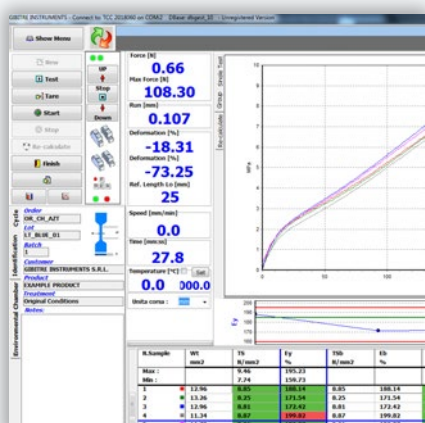

# DENSITY CHECK - PC

**PC-CONTROLLED-ELECTRONIC DENSIMETER FOR AUTOMATIC EVALUATION OF THE DENSITY, % MASS VARIATION (DM) AND % VOLUME VARIATION (DV) OF COMPACT AND CELLULAR (NON ABSORBENT) MATERIALS**

STANDARDS: ASTM D297; ASTM D471; ASTM D792; ASTM D1056; ASTM D3574; ISO 1817; ISO 2781; ISO 1183-1;



Performing a test is quick and easy:

- Apply the sample to the sample holder
- Fix the sample holder to the magnetic clamp
- Press start

The instrument automatically records the weight of the sample, moves up the beaker containing the reference liquid to measure the volume and the density. Finally moves down the beaker to the start position for the next test.

### Key Features

- top quality scale with 0.001g resolution

(optionally 0.0001g)

- Magnetic sample holder for quick sample replacement
- Thermal sensor for the reading of the temperature of the reference liquid and automatic density adjustment
- Motor controlled lifting system, which moves up and down a beaker during the automatic execution of the test
- Automatic calculation of Density and of %Mass Variation and %Volume Variation after

aging treatment of samples

- Comparison of results with tolerance limits and statistic analysis
- Storage of data and curves in standard Gibitre SQL database
- Full license of Datagest\_10 software for complete management of Gibitre SQL Database

### Accessories

Specific sample holders are available for the different kind of products.

**Balance sensitivity:**  $\pm 0.001$  g ( $\pm 0.0001$  g optional)

**Measurable density:** The instrument can be set for measuring the density of Rubber, rigid materials, foam (non absorbent), pellets, liquids; The instrument enables automatic measurements to be carried out even for samples with density of less than 1 g/cm

**Numerical test data:** Mass, volume and density (original state and after aging treatment); % mass Variation and % Volume variation

**Selection of the reference liquid:** The kind of reference liquid and the density according to the temperature of the lab can be selected.

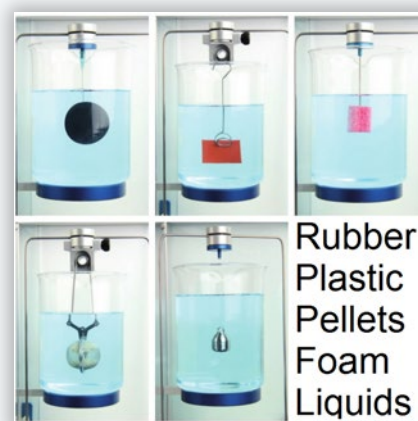
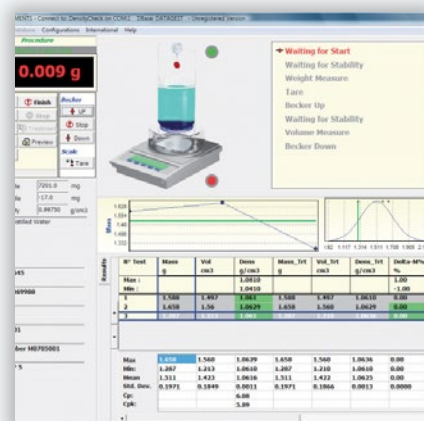

Rubber  
Plastic  
Pellets  
Foam  
Liquids

# LOW TEMPERATURE CHECK

**AUTOMATIC INSTRUMENT FOR THE DETERMINATION FOR BOTH TR TEST AND BRITTLINESS POINT**

STANDARDS: ASTM D746; ASTM D1329; ASTM D1414; ASTM D2137; FIAT 50416; FIAT 50419; ISO 812; ISO 974; ISO 2921;



Tests at low temperatures permit to evaluate the crystallization effects and to compare viscoelastic properties of rubber and rubber-like materials at low temperatures and are useful for the selection of materials suitable for low-temperature service.

**The structure** of the Low Temperature Check has been designed to permit the installation of arrangements for TR and Brittleness point tests and includes the common parts required for low temperature testing: stainless steel tank, temperature control devices, stirrer, electronic control device, safety devices and CE Labelling.

**Cooling systems:** With Refrigeration unit OR; With Liquid nitrogen tank

**Test Temperature:** -120 ÷ +20 °C (with liquid nitrogen tank); -70 ÷ +20 °C (with refrigeration unit)

**Sample holders for TR Test:** Permits to test 6 samples at the same time

**Numerical Test Data - TR test:** TR-Test: TR10,TR30,TR50,TR70,TRx (x customer defined) Time at set TR; Brittleness Point: Test temperature,

**Cooling systems** available are nitrogen tank or refrigeration unit.

The cooling is automatically controlled by the instrument according to the temperature set of the test procedure in use.

**The arrangement for TR test** includes:

- Sample holder for the simultaneous test of 6 samples
- Temperature Retraction Software, which permits to enter samples identification (up to 3 products), cool and condition the samples, start the test, plot retraction curves for each sample, calculate test results, check tolerance limits,

Save results and curves

**The arrangement for Brittleness Point test** includes:

- Pneumatically actuated striker in conformity with international standards
- Sample holder for 10 specimens
- Brittleness Point Software, which permits to cool and condition the samples, activate the striker, record the temperature and the speed of the striker, allow the user to enter test results after visual inspection, calculate and save Brittleness Point Temperature

Striker speed

**Graphic representation and printout:** Curves of % Retraction vs. Temperature for each sample. Temperature vs Time

**Sample holders:** Sample holder for 10 samples.

**Speed of striker for Brittleness Point test:** Pressure regulator for pneumatic piston Striker with automatic or manual start-up

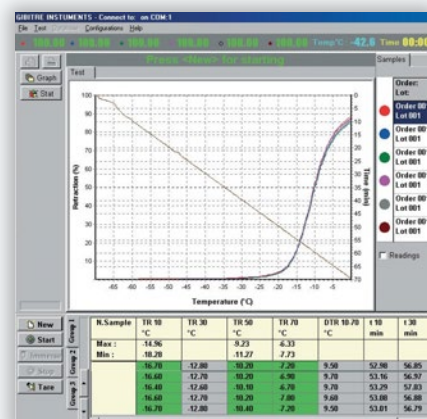
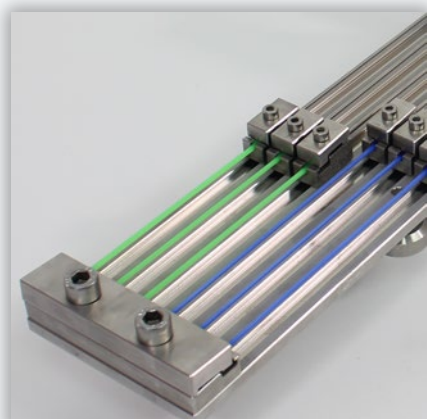

# OZONE CHECK - UV

## ELECTRONIC OZONE TESTER FOR THE EVALUATION OF OZONE RESISTANCE OF RUBBER SAMPLES

STANDARDS: ASTM D1056; ASTM D1149; ASTM D4575; FIAT 50417; ISO 3011; ISO 7326; ISO 1431-1; ISO 1431-3; ISO 6916-1; SAE J1401;

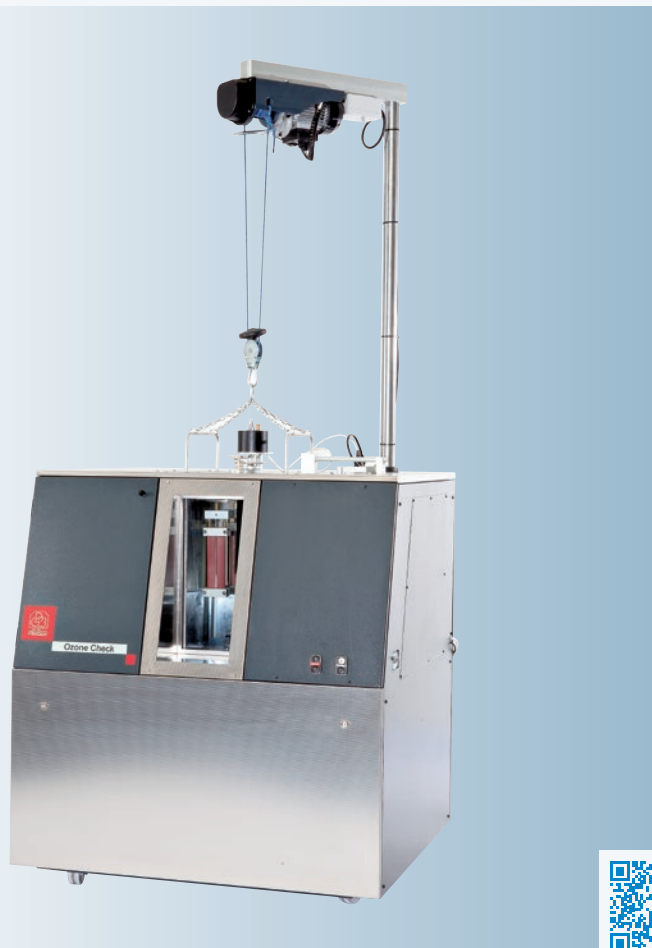

The instrument Ozone Check - UV is a complete ozone cabinet for the measurement of the resistance to cracking under static or dynamic tensile strain of rubber samples or technical articles. The instrument permits set the test conditions in order to comply with international standard methods.

### Key features

• Automatic regulation of Ozone Concentration, Temperature, Air Flow and Relative Humidity

(optional)

- Performance of Static or Dynamic tests
- UV-absorption Ozone detector
- Stainless steel cylindrical test chamber for homogeneous ozone distribution
- Generation and shooting down of the Ozone in closed circuit (no exhaust evacuation needed)
- CE labelling

### Software

Complete control using Gibitre-OzoneCheck

software which permits to set testing conditions, store results, test curves and sample images to SQL database, manage independent groups of samples with automatic test stop and test suspensions control, recovery the test after a power failure.

### Accessories

Supports for static and dynamic tests of standard samples, technical parts and rubber hoses.

**Temperature control:** From Room Temperature +5°C to 70°C. Accuracy: 0.1°C. Integrated heat interchanger for connection to a water supply.

**Control of Ozone Concentration:** Automatic between 10 and 500 PPHM by means of UV Absorption Analyzer with ± 3% accuracy

**Control of Relative Humidity (optional):** Adjustable between 40 and 90%; This option includes ultrasonic humidity Generator and Refrigeration unit.

**Air flow:** Adjustable from 0,5 to 3 changes/min (air change speed between 7 and 39 mm/sec); Internal fan according to ISO 1431.

**Test chamber:** Cylindrical Stainless Steel test chamber with internal illumination and inspection window. Ø 550 mm; H 550 mm. Volume 155 Litres

**Static Sample Holders:** • Sample holders for static strain and planetary displacement in compliance with ISO 1431-1 standard (32 to 64 samples); • Sample holders for tests on rubber hoses according to ISO 7326

**Sample holder for dynamic test:** Frequency: 3 to 30 cycles/min (0.05 to 0.5 Hz). Holder for 10 samples

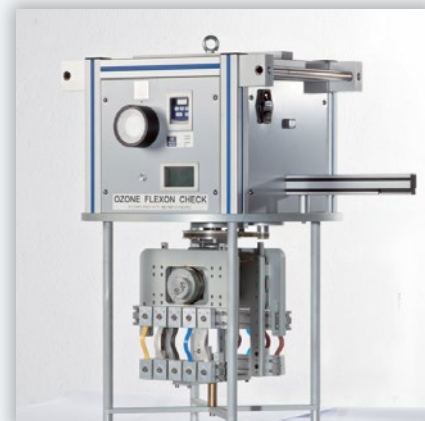
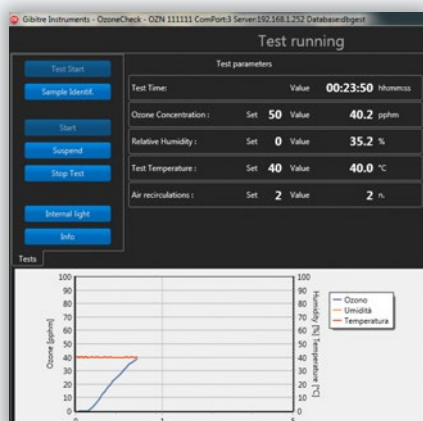





**ACCREDIA**  
L'ENTE ITALIANO DI ACCREDITAMENTO

**LAT N° 182**

Signatory of EA, IAF and ILAC  
Mutual Recognition Agreements

Membro degli accordi di Mutuo  
Riconoscimento EA, IAF e ILAC

# AUTOMATIC HARDNESS CHECK

**AUTOMATIC INSTRUMENTS FOR THE  
MEASUREMENT OF SHORE OR IRHD HARDNESS  
FITTED WITH MOTOR-CONTROLLED SAMPLE  
HOLDER.**

STANDARDS: ASTM D1414; ASTM D1415; ASTM D2240; FIAT  
50408; FIAT 50411; ISO 868; ISO 48-2; ISO 48-4;



**gibitre**  
INSTRUMENTS



Stand-alone automatic hardness units are independent hardness measurement devices designed for the execution of hardness tests according to a specific hardness scale. The instruments have been designed to meet the requirements of research labs and for production control.

The solid construction of the instrument, the high quality sensors, and the lifting system with ball-recirculation screw makes them ideal

both for research purposes and for heavy-duty production control.

Available hardness scales are: Shore A, Shore D, Shore AO, Shore OO, Shore AM, IRHD-Micro, IRHD-Normal, IRHD-Hard, IRHD-Low.

**Key Features**

- Motor controlled displacement of the sample for automatic multiple testing
- The hardness units can be controlled both with Gibitre Hardness Software and with Gibitre

Touch Screen display

- Full conformity with international standards
- ACCREDIA Calibration Certificate issued by Gibitre ISO 17025 Accredited laboratory

**Accessories**

- Extension plate for the testing of big parts.
- Centring devices for O-rings.
- Centring device for rubber hoses.

**Available hardness types:** Shore A, Shore D, Shore OO, Shore M, ; IRHD (Normal, Hard, Low), Micro-IRHD

**Unit control:** Control via Gibitre Hardness Check Software or via Gibitre Digital Display

**Test modality:** Fully automatic test in different points of the same sample

**Test results calculated for each test:** Shore units: Initial hardness, hardness values after set test times; IRHD/micro IRHD: Hardness at 30 sec (and at set test times), Angle Coeff. of Hardness Vs Time curve, Hysteresis after load removal, Correction of hardness according to sample thickness

**Resolution:** 0.01 Hardness point

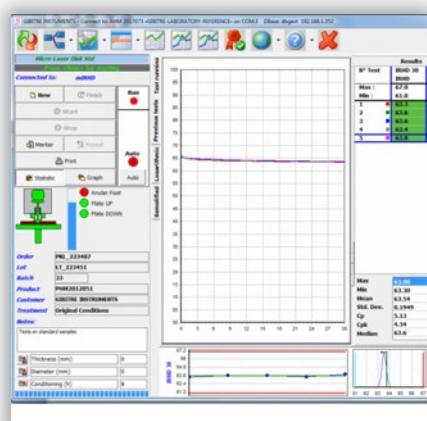

# MULTI-UNIT AUTOMATIC HARDNESS CHECK

**MULTI-UNIT HARDNESS TESTER WITH AUTOMATIC SAMPLE DISPLACEMENT. UP TO 4 DIFFERENT SHORE OR IRHD HARDNESS UNITS CAN BE INSTALLED ON THE INSTRUMENT. THE HARDNESS UNIT TO BE USED TO CARRY OUT THE AUTOMATIC TEST CAN BE EASILY SELECTED BY ROTATING THE SUPPORT.**

STANDARDS: ASTM D1415; ASTM D2240; FIAT 50408; FIAT 50411; ISO 868; ISO 48-2; ISO 48-4;



Multi-Unit Automatic hardness testing system has been designed for labs, which need to perform hardness tests according to different hardness scales.

The hardness testing unit to be used must be placed in the front position by rotating the top part of the support.

The rotating system permits to interchange the test unit within a few seconds. No dismantling or replacement of delicate parts and no specific

training are required to perform with full safety this operation. This solid technical solution is ideal even in case of frequent unit replacement. Available hardness scales are: Shore A, Shore D, Shore AO, Shore OO, Shore AM, IRHD-Micro, IRHD-Normal, IRHD-Hard, IRHD-Low.

### Key Features

- Motor controlled displacement of the sample for automatic multiple testing on the sample
- The hardness units can be controlled both

with Gibitre Hardness Software and with Gibitre Touch Screen display

- Full conformity with international standards
- ACCREDIA Calibration Certificate issued by Gibitre ISO 17025 Accredited laboratory

### Accessories

- Extension plate for the testing of big parts.
- Centring devices for O-rings.
- Centring device for rubber hoses.

**Available Hardness types:** Shore A, Shore D, Shore OO, Shore M, IRHD (Normal, Hard, Low), Micro-IRHD

**Unit control:** Control via Gibitre Hardness Check Software or via Gibitre Digital Display

**Test modality:** Fully automatic test in different points of the same sample

**Test results calculated for each test:** Shore units: Initial hardness, hardness values after set test times; IRHD/micro IRHD: Hardness at 30 sec (and at set test times), Angle Coeff. of Hardness Vs Time curve, Hysteresis after load removal, Correction of hardness according to sample thickness

**Resolution:** 0.01 Hardness point

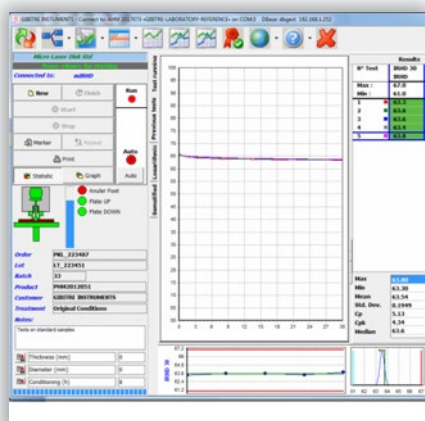

# MICRO-IRHD LASER REVOLUTION

**MICRO-IRHD HARDNESS TESTER WITH LASER CENTRING DEVICE AND ROTATING SAMPLE HOLDER FOR THE AUTOMATIC SERIAL MEASURE OF O-RING AND SMALL RUBBER PARTS**

STANDARDS: ASTM D1414; ASTM D1415; FIAT 50408; ISO 48-2;



The instrument permits to increase productivity and accuracy in performing Micro-irhd measurements by eliminating the human influence in the sample positioning.

You only need to place the items to be tested on the test line of sample positioning disk. The instrument will use the laser beam to detect the right test point for each sample and perform automatically the measure of Micro-irhd hardness in the target point.

When the complete rotation of the disk has been performed and all the samples have been tested, the instrument will warn you that

it is ready for more tests.

### Key Features

- Full conformity with ISO 48-2 and ASTM D 1415 standards
- ACCREDIA Calibration Certificate issued by Gibitre ISO 17025 Accredited laboratory
- Gibitre exclusive Micro-irhd test technology (ruby-sphere indenter, test force application using load cell)
- Fully automatic positioning of each sample in the target test point with 0.005 mm accuracy
- Automatic control of items with thickness between 1 and 60 mm

- Laser scanning of the profile of non-standard test pieces to choose and record to test position for each product
- Automatic testing of 4 different products in the 4 sectors of the sample positioning disk
- Measure of Micro-irhd hardness, Angle coefficient of the hardness relaxation curve and Hysteresis curve
- Automatic verification of tolerance limits for each product tested
- Storage of results and curves in the standard Gibitre SQL database

**Unit of measure:** IRHD-M (micro)

**Resolution:** 0.01 irhd point

**Test modality:** Serial automatic testing of the parts placed across the test line of the sample holding disk

**Calculated Results:** • IRHD Hardness; • Angle coefficient of hardness

relaxation curve;

- Hysteresis (sample return after load removal);
- Correction of hardness according to the thickness of the sample

**Laser Device:** Class 2 laser sensor; Resolution: 0.005 mm;

**Sample thickness:** Between 1 and 60 mm

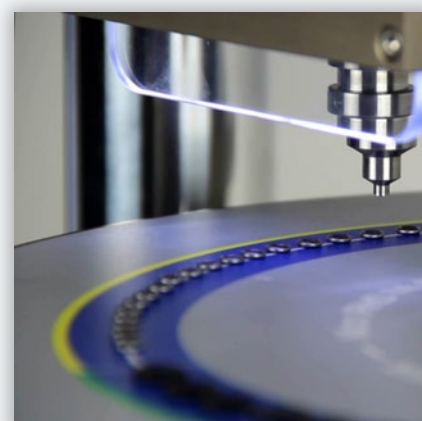
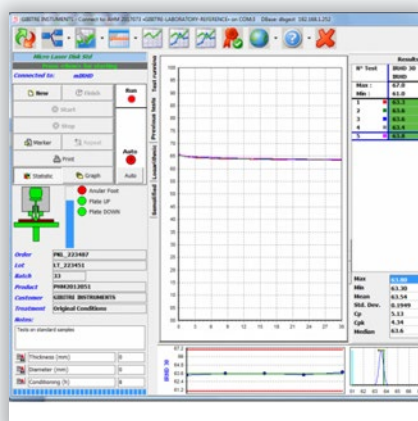
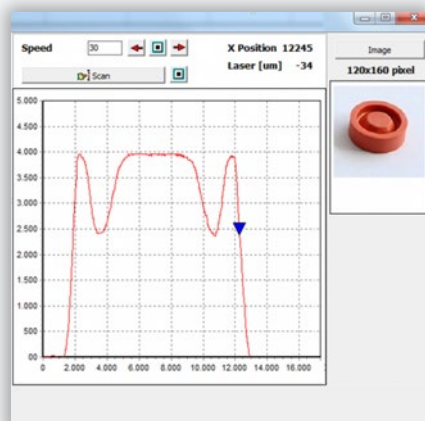

# MANUAL DIGITAL HARDNESS CHECK

**PORTABLE DIGITAL SHORE HARDNESS TESTER.  
AVAILABLE SCALES: SHORE A, D, AO, OO.**

**STANDARDS: ASTM D2240; FIAT 50411; ISO 868; ISO 48-4; ISO 7267-2;**



Digital Shore tester for the performance of hardness tests that can be used manually or in combination with support.

The instrument can be used as stand-alone device or can be connected to HardnessCheck software for automatic storage of test results.

### Key features

- High resolution sensor and frictionless mechanical construction to ensure extreme accuracy and repeatability of the measures
- Wide 25x50 mm digital display

**Hardness sensors available:** Shore (A, D, OO, AO)

**Calculated Results:** Initial hardness, hardness values after customer defined test times.

**Resolution:** 0.01 Shore points

**Digital Display:** 25x50 mm (128x64 Pixels)

**Battery:** Lithium battery for up to 8 hours continuous usage

- Long-duration Lithium rechargeable battery
- Calculation of Initial hardness and hardness after set test time
- Storage of 20 measures in the memory of the device for further transmission to the software
- Control of the approaching force applied to the instrument in manual use
- Optional Windows-based software for the direct acquisition of data and curves during the execution of the test

- Easy insertion of the instrument into the support housing hole (no fixings or adjustments are required)

### Accessories

- Support with manual sample displacement
- Radio transmission device for sending the data to pc (max distance from the pc: 15 m)
- Additional holder for the testing on round surfaces
- ACCREDIA calibration Certificate issued by Gibitre ISO-17025-Certified laboratory

**Battery Charge:** Usb cable and plaque for 110/220 V 50/60Hz included

**Support features:** Adjustable distance between hardness sensor and sample (Max 160 mm)

**Radio Transmission (Optional):** Permits radio transmission of results to a PC (up to 15 m)

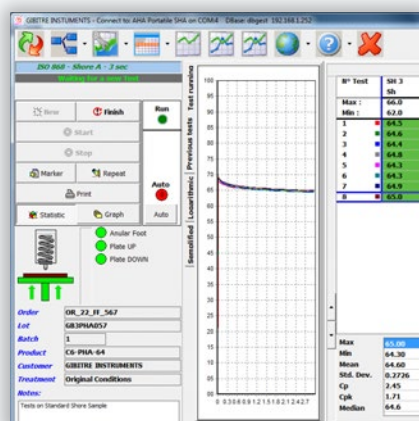



# ACCREDIA CALIBRATION SERVICE

GIBITRE INSTRUMENTS IS OFFICIAL ACCREDIA CALIBRATION LABORATORY N° 182 ACCORDING TO ISO 17025 STANDARD AND PROVIDES CALIBRATION SERVICE FOR SHORE AND IRHD HARDNESS TESTERS.

STANDARDS: ISO 868; ISO 48-2; ISO 48-4; ISO 17025;



## LAT N° 182

### Signatory of EA, IAF and ILAC Mutual Recognition Agreements

### Membro degli accordi di Mutuo Riconoscimento EA, IAF e ILAC



Gibitre Instruments' metrological laboratory is official ACCREDIA calibration laboratory for the calibration of:

- Shore A, Shore D, tester according to ISO 48-4 and ISO 868 standards
- IRHD Micro, IRHD-Normal, IRHD-Hard, and IRHD-Low hardness testers according to ISO 48-2 standard.

Calibrations are performed in the metrology room of Gibitre Instruments, with controlled

environmental conditions.

#### Key Features

- Gibitre performs Accredia calibration of IRHD and Shore testers produced by all the major world producers.
- Gibitre has a solid experience regarding the manipulation and calibration of hardness testers and performs more than 300 calibrations per year
- Recording of pre-calibration and post-calibration

measures are provided together with the Calibration certificate

- Delivery date of the instrument can be agreed in order to have back-shipment within 24 hours from delivery
- Instruments that do not meet the Accredia calibration requirements are returned without charging calibration service

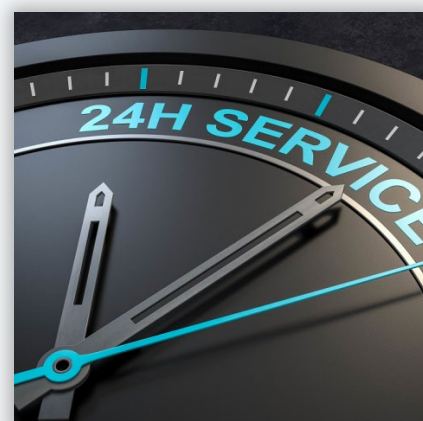
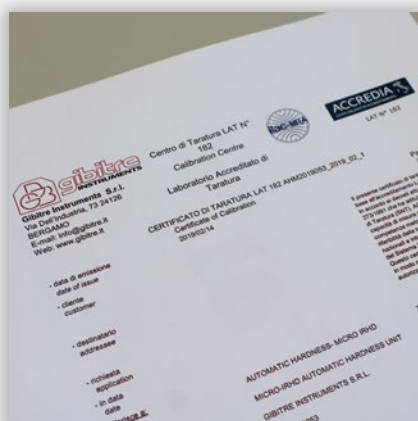

# CERTIFIED SAMPLES

GIBITRE INSTRUMENTS PROVIDES CERTIFIED SAMPLES FOR SHORE AND IRHD HARDNESS VERIFICATION



The use of certified samples permits to perform periodical verification of the conformity of the reading of your hardness testers in the period between two calibrations.

Periodical verification is useful considering the importance of hardness as a testing parameter.

### Characteristics of the product

The hardness of elastomeric products is strongly influenced by the temperature. For this reason, the samples produced by Gibitre have

a shape that permits easy handling without transmitting the heat of the hand to the testing area.

The samples are provided with calibration Certificate with traceability to the certified hardness tester used for the measurements.

The samples are provide with an insulated protection case that permits the protection of the samples from temperature variations and from the light.

### Available Configurations

Gibitre provides samples for testing Shore A, Shore D, IRHD-N and IRHD-Micro hardness.

The following configurations are available:

- Complete box including 5 samples with different hardness within the selected hardness scale (approximately 40 - 50 - 60 - 80 - 90)
- Box containing one single sample with one of the available hardness

**Shape of the samples:** The shape of the samples has been developed to permit easy handling without heat transmission to the test area

**Protection Box:** The wooden box ensures protection against light and temperature variations

**Sample identification:** The samples have unique identification code to

permit the traceability of the calibration

**Calibration Report:** The calibration report is issued by Gibitre Instruments and includes the traceability to the officially-calibrated hardness tester used for the measures



# REBOUND CHECK

SCHOB TYPE REBOUND TESTER FITTED WITH TOUCH-SCREEN DISPLAY SYSTEM FOR THE CALCULATION OF THE RESILIENCE OF ELASTOMERS WITH HARDNESS BETWEEN 30 AND 85 IRHD.

STANDARDS: ASTM D7121; ISO 4662;



The Resilience is the ratio between energy yield and energy applied in the impact between the instrument's hammer and the specimen. This measure provides useful indications regarding the dynamic behavior of an elastomer. The characteristics of the specimen, of the hammer and of the fixing tool are defined by the standards to ensure repeatable results.

The measurement is performed by measuring the rebound angle of the hammer following the impact.

The instrument provides direct reading of the resilience value.

**The touch-screen display** permits to:

- display the results of 5 tests made on the sample

- calculate mean and standard deviation of the results
- calibrate the angle reading of the instrument
- Export the data

**The sample holder**, conforming to ISO 4662 and ASTM D 7121 standards, is supplied with a tool for easy insertion and removal of the sample.

**Test method:** Recording of 5 test results (Rebound %) and automatic calculation of mean and standard deviation.

**Sensitivity:** 0.2 %

**Control Display:** Touch Screen display for instrument setup and results display; The display permits to: - display the results of 5 tests; - calculate mean and standard deviation of the results; - calibrate the angle

reading of the instrument; - Export the data

**Display Dimensions:** External dimensions W 92 x D 150 x H 30 mm - Usable Area 60 x 100 mm

**Data transmission:** Usb port for data export ; Windows based software for data storage available.



Instruments srl - Import Data Rs232			
File Database Setting Connection Help			
Hardness-ShoreA Matr. AHA DIG111			
Shore A RS232			
New	Order :	Operator :	
End	Order 001	Administrator	
Print	Lot :	Customer :	
Connect	Lot 001	Customer 01	
COM 2	Batch :	Product :	
	1	Compound 01	
N° Test	SH 3 Sh	SHlni Sh	
Max :	54.8	0.0	
Min :	50.8	0.0	
32	0051.9	0053.8	
34	0052.3	0055.0	
36	0052.4	0055.1	
38	0052.4	0055.3	
39	0052.0	0055.9	

# DE MATTIA FATIGUE CHECK

**DYNAMIC TESTER FOR THE EXECUTION OF FATIGUE TESTS IN TRACTION AND BENDING IN COMPLIANCE WITH INTERNATIONAL STANDARDS**

STANDARDS: ASTM D813; ASTM D430-B; ISO 132; ISO 6943;



The instrument permits to perform dynamic tests for the determination of fatigue resistance of vulcanized rubbers under repeated deformations.

This instrument permits to perform Flex Cracking, Crack Growth and Tension fatigue tests.

### Technical Characteristics

According to test specification, the instrument

can be easily adjusted by setting:

- Test frequency (60 to 300 rpm)
- Test stroke (0 to 60 mm)
- The distance of the grips (up to 100 mm)
- The number of cycles before automatic stop can be set (up to 1.000.000)

### Key Features

Up to 16 samples can be tested at the same time.

Exclusive movement system with both sample holders moving in opposite directions to ensure low levels of noise and vibrations.

CE labelling

### Accessories

Piercing tool.

Mould for sample preparation.

**Speed adjustment:** from 60 to 300 Cycles/min - 1 to 5 Hz

**Run Adjustment:** Between 0 and 60 mm

**Distance of the clamps:** Max 100 mm

**Sample Holder:** 16 samples can be tested at the same time

**Data displayed:** Set number of cycles, Cycles performed, oscillation Frequency

**Noise Level:** <50 dB

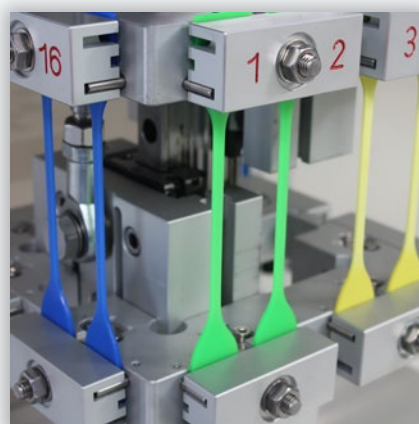



# DE MATTIA FATIGUE CHECK - PLUS

**DYNAMIC TESTER FOR THE EXECUTION OF FATIGUE TESTS AT CONTROLLED TEMPERATURE (-40 ÷ +200°C)**

STANDARDS: ASTM D813; ASTM D430-B; ISO 132; ISO 6943;



The instrument permits to perform dynamic tests at controlled temperature for the determination of fatigue resistance of vulcanized rubbers under repeated deformations.

This instrument permits to perform Flex Cracking, Crack Growth and Tension fatigue tests.

### Technical Characteristics

According to test specification, the instrument can be easily adjusted by setting:

- Test Temperature (-40 to +200°C)
- Test frequency (60 to 300 rpm, 1 to 5 Hz)
- Test stroke (0 to 60 mm)
- The distance of the grips (up to 100 mm)
- The number of cycles before automatic stop can be set (up to 1.000.000)

### Key Features

The cooling of environmental chamber by refrigeration unit integrated into the instrument. Inspection window with internal led lighting for

sample inspection.

Up to 12 samples can be tested at the same time.

Exclusive movement system with both sample holders moving in opposite directions to ensure low levels of noise and vibrations.

CE labelling.

### Accessories

Piercing tool.

Mould for sample preparation.

**Speed adjustment:** from 30 to 300 Cycles/min - 0.5 to 5 Hz

**Run adjustment:** Between 0 and 60 mm

**Distance of the grips:** Maximum 100 mm

**Data displayed:** Number of oscillations, test Temperature

**Sample holder:** 12 samples can be tested at the same time

**Test temperature (with refrigeration unit):** From -40°C to 200°C (1°C resolution).

**Noise level:** < 50 dB

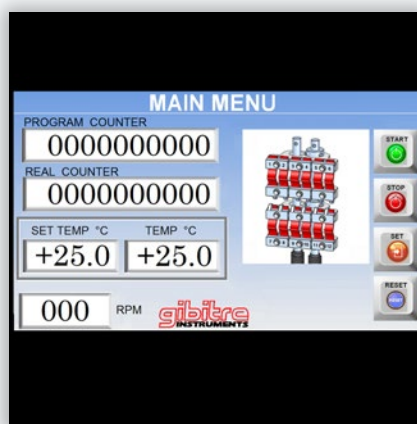

# ABRASION CHECK

ABRASION TESTER IN COMPLIANCE WITH ISO 4649, ASTM D 5963 (DIN 53 516) STANDARDS

STANDARDS: ASTM D5963; ISO 4649;



The abrasion test gives a comparative evaluation of the resistance to the abrasion of specimens made of vulcanized rubber, plastic and different materials.

### Description of the test

A cylindrical specimen, obtained by moulding or punched from a finished product, is inserted into the locking clamp. During the standard abrasion cycle, the specimen is pressed with a defined force against a rotating drum to which certified abrasive paper is applied.

The measurement of the volume variation of

the specimen after the abrasion cycle is carried out with a millesimal scale (not included in the supply).

### Key Features

- Easy setup of the instrument to perform tests with or without axial sample rotation
- Quick change of the weights to set the vertical force
- Detection of premature sample consumption with automatic test stop
- Special design of the sample holder with regulation of closure force of the sample and

accurate set of sample protrusion

- Electronic motor controller for accurate control of the rotating speed of the drum
- Integrated brush for continuous drum cleaning during the test
- Drum unlock system to ease the replacement of the abrasive paper and the cleaning of the instrument
- Transparent protection cover
- CE Labelling

**Test Setup:** • Test with/without sample rotation; • Selection of vertical force on the sample (5, 10, 20N - Other on request); • Test with reduced run

**Sample Holder Characteristics:** - Adjustable Sample closure regulation; - Lateral displacement of the sample: 4.20 mm per revolution of the drum; - Automatic placement of the test piece on the sheet at the

beginning of the test and Automatic removal at test end

**Drum release:** Mechanical release of the drum for easy emery cloth replacement and instrument cleaning

**Notes:** A millesimal scale (not included) is used to calculate the reduction in volume of the specimen

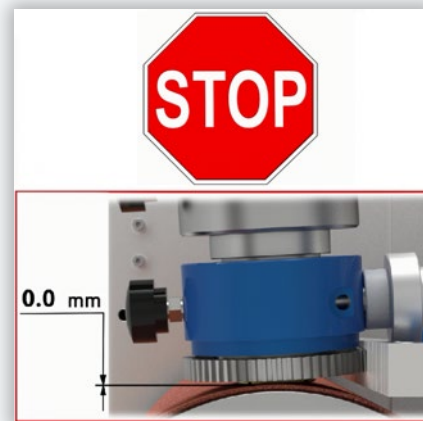

# HOSE ABRASION CHECK

**INSTRUMENT FOR THE DETERMINATION OF THE ABRASION RESISTANCE OF THE OUTER COVER OF RUBBER HOSES.**

STANDARDS: ISO 6945; ISO 7840; SAE J2006;



The instrument permits to perform standard tests and to customize test conditions. It can be successfully used both for production control and for research and development purposes.

### Standard test cycle

The hose under test rotates at a constant speed while the abrasion tool moves back and forth, parallel to the axis of the hose.

During each test cycle the hose performs a complete rotation and the abrasion tool performs a complete back and forth movement.

The instrument automatically stops, when the set number of cycles has been performed. The evaluation of the result is made by checking if the hose has rigid helix exposed and by measuring the quantity of material removed from the abrasion tool.

### Key Features

- Solid structure to prevent vibrations and ensure long duration
- Quick replacement of the abrasion tool
- Interchangeable weights to set the vertical

force on the abrasion tool

- Digital speed controller with speed selection
- Digital counter of test cycles
- Hoses with external diameter up to 100 mm can be tested
- Easy setup of the instrument to select test mode and perform tests with or without axial hose rotation
- Locked protection door and safety push-button
- CE Labelling

**Standard abrasion tool:** Abrasive paper 80 Grit, coarse AL203 emery cloth is firmly affixed to a hard surface with 25 x 75 ± 5 mm dimension

**Rotation speed of the hose :** Selector with 3 speeds: 60, 75, 80 RPM

**External Diameter of the hose:** Minimum: 10 mm; Maximum: 100 mm

external diameter

**Vertical force:** Standard 45 ± 5 N. Different on request

**Set of number of cycles:** A digital selector permits the total number of cycles to be set according to the kind of hose to test.

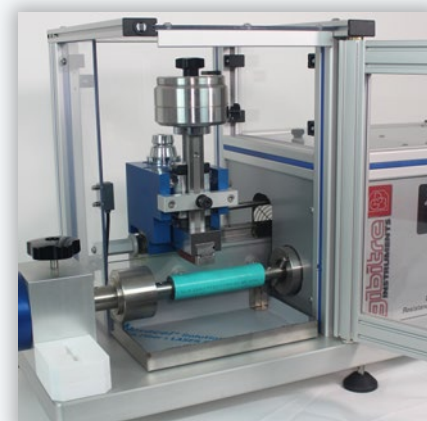

# BLOCK OVEN AGING CHECK

**THERMAL REGULATED BLOCK FOR THE  
PERFORMANCE OF AGEING TESTS IN AIR AND  
IN LIQUIDS OF ELASTOMERIC MATERIALS AT  
TEMPERATURES UP TO 250°C**

**STANDARDS: ASTM D471; ASTM D865; ASTM D1056; ISO 188; ISO 1817; ISO 6916-1;**



Thermal regulated Block for the performance of aging tests in air and in liquids of elastomeric materials at temperatures up to 250°C.

### Technical Characteristics

The instrument is fitted with:

- aluminium block with 4 calibrated holes designed for the insertion of 4 glass test tubes
- stainless steel housing with thermal insulation and external rack for easy sample preparation

• heating resistance

- PT 100 thermal probe for temperature measurement
- PID thermoregulator
- Timer for the set of the heating time with automatic switch off of the heater at the end of the set time

the set time

- safety switch to prevent overheating

### Accessories

Glass tubes with 38 mm diameter and 300 mm length

Water-cooled reflux condenser

**Test stations:** N° 4 glass tubes with 38 mm diameter and 300 mm length The use of individual test stations eliminate cross-contamination among different products under test

**Heating system:** The thermal resistance surrounding the round-shaped aluminium block ensures uniform heating of the system

**Vapour phase recovery:** By condensation with water-cooled reflux condenser

condenser

**Temperature control range:** From room temperature to 250°C (Resolution 1 °C)

**Timer for set of test time:** Timer with set of hours and minutes with automatic switching off of the heating system at the end of the time



# COMPRESSION SET - CONSTANT FORCE



**INSTRUMENT FOR THE EXECUTION OF  
COMPRESSION FOR TESTS UNDER CONSTANT  
FORCE IN COMPLIANCE WITH ASTM D 395 METHOD  
A, UNI 4913-2, FIAT 50410 STANDARDS**

STANDARDS: ASTM D395-A; FIAT 50410; UNI 4913-2;



The instrument permits to insert the sample in the test position and to set the closure force. The test is performed by placing the whole device in an oven at the set temperature.

### Key Features

- Calibrated spring
- Easy selection of the force that the spring applies to the sample
- Wide range of available calibrated forces according to standard requirements

- Low friction bushings
- Made of Chrome-plated steel

### Accessories

Mould for samples preparation

**Applicable fores:** 130, 230, 360, 456, 530, 820, 1000, 1800, 1833, 2400

**Dimensions:** Ø 180 mm, H 460 mm

**Weight:** 14 kg

**Construction:** The device is made of Chrome Plated steel

# COMPRESSION SET - STANDARD



**INSTRUMENT FOR THE EXECUTION OF  
COMPRESSION SET TEST AT CONSTANT  
DEFORMATION.**

STANDARDS: ASTM D1056; ASTM D1414; ASTM D395-B; FIAT 50410; ISO 815; ISO 1856; ISO 6916-I;

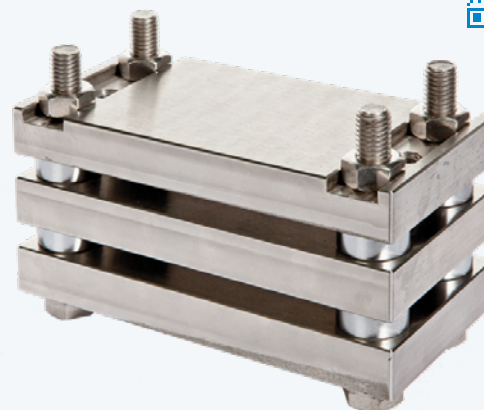

The instruments consist of stainless steel platens, stainless steel spacers with standard or custom thickness and 4 Screws for closure of the platens.

### Key features

- The instrument can be supplied with 2 or 3 platens according to the number of tests to

- perform at the same time
- Accurate surface finishing of the test platens in conformity to standard requirements
- Spacer rings with thickness according to international standards or customer defined.
- 4 Screws closure system to ensure correct sample closure

- Replaceable screws and nuts for high temperature application

### Accessories

Mould for sample preparation

Thickness meter for the measure of sample thickness.

**Dimensions of the plates (each):** (WxDxH) 80x160x15 mm

**Number of plates:** 2 or 3

**Spacers for big compression set sample according to the different standards:** ISO 815 Type A: 9,35 mm ± 0,05 mm; ASTM D 395 Type

1A: 9,5 mm ± 0,02 mm ; DIN 53 517-II: 9,38 mm ± 0,01 mm

**Spacers for small compression set sample according to the different standards:** ISO 815 Type B: 4,75mm±0,05mm; ASTM D 395 type 2B: 4,5mm±0,01mm ; DIN 53 517-I: 4,72mm±0,01mm

# COMPRESSION SET - PV 3307

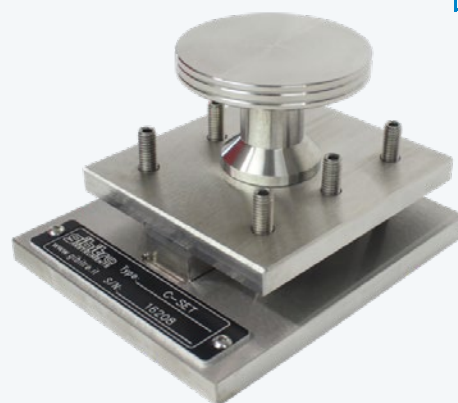

**STAINLESS STEEL INSTRUMENT FOR PLASTIC AND ELASTIC DEFORMABILITY OF ELASTOMERIC MATERIALS**

**STANDARDS:** PV 3307;

Thickness meter for sample measurement in compliance with PV 3307 requirements

### Key Features

- Entirely made of stainless steel
- Construction and surface finishing totally conforming to the standard specification

- The device permits to perform the deformability test on 6 rubber and plastic samples with 15 mm diameter and 2 mm thickness

### Accessories

**Sample dimension:** 15 mm diameter and 2 mm thickness. The instrument can be regulated for testing samples with other dimension.

**Number of Samples:** 6

**External Dimensions of the device:** 90 x 90 x 90 mm

**Weight:** 1.5 kg

# COMPRESSION SET - PV 3330

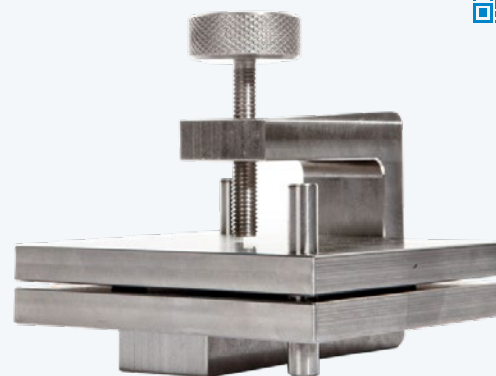

**STAINLESS STEEL COMPRESSION SET DEVICE FOR THE PERFORMANCE OF COMPRESSION SET TESTS ON FINISHED PARTS ACCORDING TO PV 3330 STANDARD.**

**STANDARDS:** PV 3330;

Additional spacers according to customer specification

Thickness meter for sample measurement in conformity with PV 3330 requirements

The device is designed for the testing of the permanent deformation of finished parts and O-rings.

### Key Features

- Entirely made of stainless steel

- Construction and surface finishing totally conforming to the standard specification
- Thickness of spacers according to customer specification

### Accessories

**Distance of the plates:** The distance of the plates is regulated with 4 spacers.; Spacers of customer defined thickness can be provided.

**External Dimensions:** 120 x 100 x 100 mm

**Weight:** 1.5 kg

# COMPRESSION SET - ADJUSTABLE

COMPRESSION SET DEVICE MADE OF STAINLESS STEEL WITH ADJUSTABLE DISTANCE BETWEEN THE PLATES

STANDARDS: ASTM D1414; ASTM D395-B; FIAT 50410; ISO 815; ISO 1856;



The instrument is designed for the execution of tests on finished articles because the distance of the plates can be adjusted according to the thickness of the samples and of the deformation to be applied.

The accurate construction method makes it ideal both for the testing on O-rings or small-size

finished articles and for standard specimens.

### Key Features

- Entirely made of stainless steel
- Wide usable surface (100 mm diameter)
- Adjustable distance between the test surfaces between 0 and 20 mm
- Perfect parallelism between the test surfaces

(flatness error less than 0.01mm)

The adjustment of the distance between the plates is performed using a standard thickness meter (optional).

**Thickness regulation:** Between 0 and 20 mm

**Usable test area:** Diameter 100 mm

**External Dimensions:** Diameter 140 mm, Height 120 mm

**Weight:** 8 kg

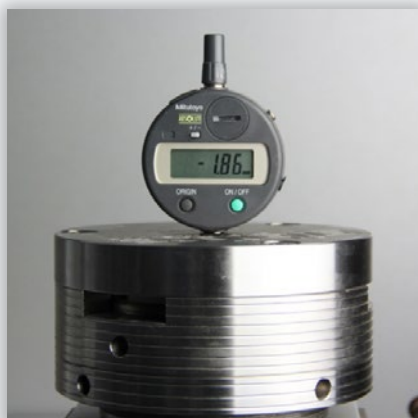

# FLAMMABILITY CHECK

STAINLESS STEEL CABINET FOR PERFORMING FLAMMABILITY TESTS OF PLASTIC MATERIALS, FOAMS AND RUBBER ACCORDING TO UL 94, ASTM D 635 AND EQUIVALENTS

STANDARDS: ASTM D635; ASTM D3801; ASTM D4804; ASTM D4986; ASTM D5048; ISO 9772; ISO 9773;



Instrument for flame resistance test according to UL 94 standard fitted with:

- Stainless steel cabinet with tempered glass viewing window and interior light
- Bunsen burner according to ASTM D 5025 standard
- Flow meter for gas flow regulation
- Support for flame angle set (0°, 20°, 45°)
- Slide for the regulation of the position of the flame

- Sample holder according to the standards with sample position regulation
  - Digital thermometer for the measurement of the temperature of the flame
  - Digital Timer with 0.1-second resolution for the measurement of test time
  - Exhaust fan to remove combustion fumes
- Available Sample Holders** for
- Horizontal Burning (HB)
  - Horizontal Burning of Cellular Polymeric

- materials (HBF)
- Vertical Burning of Non-rigid Solid Plastics (MVB)
- Vertical Burning of Solid Plastics (VB)

### Accessories

Temperature Calibrator with thermocouple for 20 mm test flame according to ASTM D 5207 standard.

**Types of test that can be performed:** HBF (Horizontal Burning Foamed Material), HB (Horizontal Burning), MVB (Material Vertical Burning), VB (Vertical Burning)

**Test Cabinet:** Stainless steel cabinet with tempered glass viewing window and interior Light.

**Burner:** Conforming to ASTM D 5025 standard. With support for flame angle set (0°, 20°, 45°).

**Temperature Control:** Digital thermometer for the measurement of the

temperature of the flame.

**Aspiration of Fumes:** Exhaust fan to remove products of combustion.

**Flow Regulation:** Flow meter for gas flow regulation.

**Timer:** Digital Timer with 0.1 sec. Resolution. The timer permits to set the Flame exposition time. At the end of the count down for flame exposition, the timer permits to count flame extinction time.

**Slide for the regulation of the position:** The Slide is controlled by an external handle that permits to move the Burner inside the chamber.





# LABORATORY PRESS

LABORATORY PRESS, WITH 250X250 MM PLATENS AND 25 T CLOSURE FORCE, FOR THE COMPRESSION MOULDING OF PLATES AND SPECIMENS.

STANDARDS: ASTM D3182; ISO 2393; ISO 6916-1; UNI 5572;



**gibitre**  
INSTRUMENTS

The laboratory press is an important tool for the preparing of samples with reproducible characteristics. Uniform temperature distribution over the platen surface, mechanical solidity to ensure constant thickness of the sample and consistent closure force are basic elements to ensure this result.

### Key Features

- Mechanical structure with 4 columns (with 60 mm diameter) and sliding platen driven by self-lubricating bushings
- Hydraulic system with 25 tons closure force

**Max useable platen surface:** 250 mm x 250 mm

**Max closure force:** 25 Tons

**Temperatures:** Up to 250°C (300°C optional), 0.1°C Resolution

**Touch Screen PLC controller (optional):** PLC with touch-screen display. Permits to: - set displacements of the moving plate; - set the temperatures; - activate the cooling and cooling rate (with cooling option); - set closure force (with force regulation option)

- 250x250 mm chrome plated steel platens with 40 mm thickness
- Specifically designed flat heating elements to ensure uniform temperature distribution over the platen surface
- Closed moulding area for easy fume aspiration
- Protection doors with safety lock
- CE Labelling

### Accessories

- Automatic Press Control with Touch-screen display: permits to set the moulding cycle

- Cooling system: controls the cooling of the platens to mould thermoplastic products.
- Closure Force Control: permits continuous regulation of the closure force to be set for each step of the moulding cycle.
- Press\_Control Software: permits to record and store the moulding condition for each moulding cycle.
- Moulds for producing plates and different types of samples according to international standards.

**Closure Force Regulator (optional):** Special hydraulic setup for continuous regulation of the closure force. Adjustable closure force between 6 and 250kN. Regulation error <10%.

**Platen cooling (optional):** Press Platens with water cooling circuit; The control of the cooling and of the cooling rate is controlled by the PLC controller; The connection to a water source or a Chiller is required (fittings 1/4")

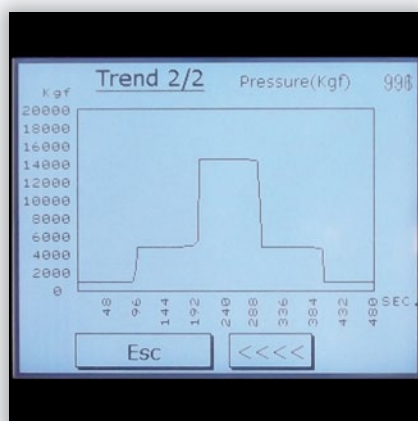

# MULTI-HEAD DIE CUTTER

MANUAL DIE CUTTING FOR PREPARING SPECIMENS FOR LABORATORY TESTING



**gibitre**  
INSTRUMENTS

Solid device for the preparation of test samples.

### Key Features

- Up to 4 cutters can be mounted on the machine to avoid the need of replacement
- The cutter to be used can be quickly placed in the working position by rotating the cutter

holding system

- Each cutting unit has independent adjustment of vertical position to improve ease of use and repeatability in specimen production
- Optimized construction to minimize the force needed for the cutting

### Accessories

Die Cutters for preparing samples according to international standards or in compliance with specific customer requirements.

2-hands system for the release of the cutting handle.

**Max working force:** 2000 Kg

**Max number of die cutters:** 4 die cutters simultaneously on the die

cutting apparatus (using the optional cutter holders).

**Standard Codol:** Ø 25 x H 20 mm (other codols available on request)

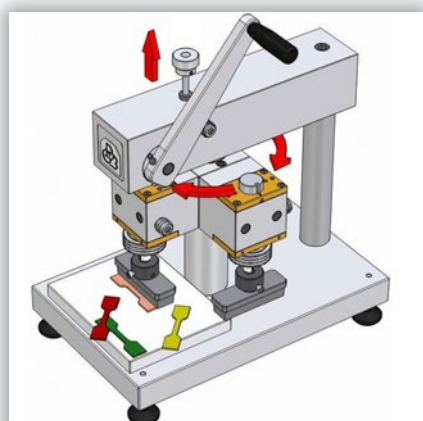

# DIE CUTTERS

GIBITRE INSTRUMENTS PROVIDES CUTTERS ACCORDING TO INTERNATIONAL STANDARDS.



Gibitre provides cutters conforming to international test standards. The cutters are used for preparing samples using a cutting machine (produced by Gibitre or other).

### Key Features

- The cutters are made of Steel for Moulds and are subjected to hardening heat treatment to ensure long duration
- The cutters are supplied with Calibration Report with traceability to primary standards
- The cutters can be fitted with a spring ejector

- for the easy extraction of the sample
- All the cutters are provided with a wooden protection box
- The cutters are specifically produced to permit multiple re-sharpening

**Conformity with standards:** All the cutters produced are designed to fulfil international standards

**Calibration certificate:** A calibration certificate with traceability to primary standards can be prepared on request.

**Extraction of the sample:** Most of the cutters can be fitted with spring ejector for the easy extraction of the sample.

**Protection Box:** All the cutters are provided with a wooden protection box.



**gibitre INSTRUMENTS** Gibitre Instruments S.p.A. Via Dell'Industria, 79 24126 BORGAMO - ITALY Tel. +39035460249 E-mail: info@gibitre.it - http://www.gibitre.it CER\_PUG\_001 Rev. 03

**Calibration Report n° 1902\_7204**

Calibration of: **Dimensions of the Die Cutter**  
Model: **900\_32\_1198\_2**  
Serial n°: **0**

Procedure: The significant dimensions are measured using a certified optical machine

Reference instruments: **MHO2 (M+2.5 mm)** Uncertainty: 0.00 mm Range: 0.00 mm

Dim	Expected value	Minimum Allowed	Maximum Allowed	Measure	Deviation	Uncertainty	Outcome
B0	12.5	-1.0	1.0	12.59	0.1	0.0	OK
B2	12.5	-1.0	1.0	12.60	0.1	0.0	OK
A	79.0	0.0	1.0	78.10	-0.1	0.0	OK
F1	8.0	-0.5	0.5	7.91	-0.2	0.0	OK
F2	8.0	-0.5	0.5	7.89	-0.1	0.0	OK
E3	8.0	-0.5	0.5	8.00	0.0	0.0	OK
E4	8.0	-0.5	0.5	7.91	-0.1	0.0	OK
F3	12.5	-1.0	1.0	12.85	0.4	0.0	OK
F2	12.5	-1.0	1.0	12.69	0.0	0.0	OK
F3	12.5	-1.0	1.0	12.41	-0.1	0.0	OK
F4	12.5	-1.0	1.0	12.51	0.0	0.0	OK
D	4.0	-0.1	0.1	4.02	0.0	0.0	OK

# SPLITTING MACHINE

LABORATORY SPLITTING MACHINE FOR THE PREPARATION OF TEST SAMPLES STARTING FROM FINISHED RUBBER PRODUCTS

STANDARDS: ASTM D1056; ASTM D3183; ISO 23529;



The machine permits to produce samples with customer defined thickness starting from finished products. The part to be cut is inserted between the motor-driven feed steel rollers and a blade, which position can be regulated with 0,01 mm accuracy, splits the part horizontally.

The machine has been specifically developed to ensure the preparation of samples with accurate thickness control and smooth surface finishing while splitting rubber or thermoplastic products with hardness between 30 and 75 Shore A.

### Key Features

- Maximum Working width 300 mm
- Adjustable cutting thickness (between 0.5 and 8 mm)
- Control panel with digital indication of the set cutting thickness with 0.01 mm resolution
- Upper and lower motor driven steel feed rollers with adjustable speed (0.9 / 1.8 / 2.8 m/min)

- Sharpening device with micrometric drive
- Integrated lubrication of both the upper and lower surface of the blade
- Manual Micrometric knife positioning and compensation for knife consumption
- Optical group to control the chamfer position and symmetry
- CE Labelling

### Accessories

- Removable aspiration unit.
- Lubricating liquid.

**Working width:** 300 mm

**Maximum cutting thickness:** 8 mm

**Minimum cutting thickness:** 0.5

**Sharpening system:** Sharpening device with micrometric drive integrated in the machine

ted in the machine

**Feed:** Manual feed speed selection: 0.9, 1.8, 2.8 m/min

**Aspiration Unit (optional):** Removable aspiration unit. Power 250 W

**Lubrication Unit:** Automatic lubrication unit with lubrication tank

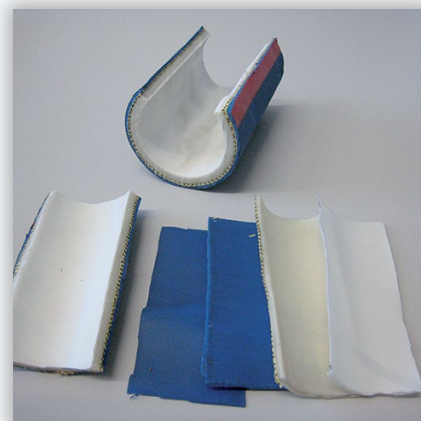

# MAINTENANCE AND CALIBRATION SERVICE

**GIBITRE INSTRUMENTS PROVIDES MAINTENANCE AND CALIBRATION SERVICE FOR ALL INSTRUMENTS INSTALLED. CALIBRATION IS CARRIED OUT USING REFERENCE INSTRUMENTS WITH TRACEABILITY TO PRIMARY STANDARDS BY GIBITRE**



## Characteristics of the Service

Gibitre Instruments provides maintenance and calibration services for all the instruments produced. The services offered have been studied and is continuously improved in order to meet the highest requirements of the customers referring to the reliability of the measures and calibration documentation. The service is coordinated directly from the Gibitre office for most European countries or is provided by a Gibitre agency through technicians directly trained

and qualified by Gibitre.

## Programmed Maintenance and Calibration Service

The service is offered in the form of an annual Maintenance Contract and includes:

- the cost for the maintenance and calibration of each Gibitre instrument owned by the customer
- the cost for the transfer of the technician that is evaluated based on the distance, the number of operations scheduled in the year and the

estimated work time for the provision of the service

- activation of the Remote Assistance service for the duration of the maintenance contract (for instruments controlled via PC)
- optional software update services

The number of annual maintenance / calibration for each instrument and the timing of execution of the activities are defined according to customer needs.

# REMOTE ASSISTANCE SERVICE USING TEAM VIEWER SOFTWARE



## Purpose of the service

The purposes of the service are:

- the identification of working problems of instruments' connected to Gibitre softwares;
- the remote installation of programs on new pcs.

## Characteristics of the service

The service is provided using Team Viewer software, for which Gibitre owns official licen-

ses.

The remote assistance must be explicitly requested and activated by the customer every time because the installation of the program does not permit any kind of automatic or not explicitly requested reconnections to your computers

For the use of remote assistance software an

active internet connection of the pc is required.

## Subscription of the service

The service is free of cost for assistance of instruments in warranty periods and for customers who subscribe a maintenance contract including this option.

You can easily activate the service by accessing Gibitre web site.



# CUSTOM SETUPS

A COMPLETE HARDWARE AND FIRMWARE DEVELOPMENT DEPARTMENT TO FULFILL CUSTOMER NEEDS.

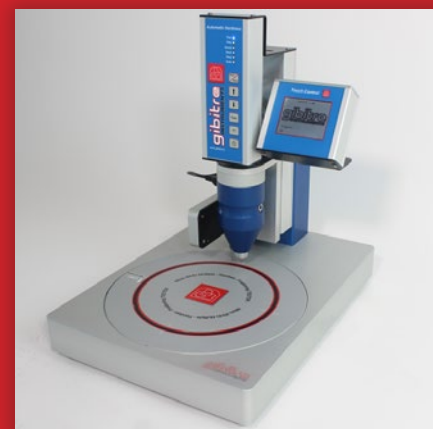
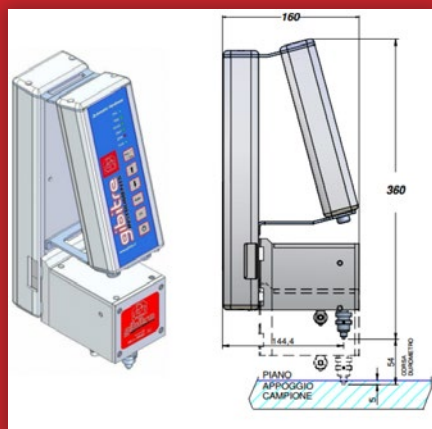

Gibitre Instruments has a complete development department fitted with 3D-CAD software, integrated CAD-CAM system, last-generation CNC working machines internal Firmware and Software development. This powerful integration is used for the

development of new instruments and for the study and production of specific solutions to the needs of the customers. Many tools like Moulds for Laboratory Press or Grips for Tensile tester are produced to need specific requirements.

In addition, customized setups for the instruments in the catalogue, which include modification of electronic, firmware and software may be developed to optimize the instruments for new applications.





**gibitre**  
**INSTRUMENTS**

Gibitre Instruments s.r.l.  
Via dell'Industria, 73  
24126 Bergamo - Italy

Tel.: +39.035.460146  
Fax: +39.035.460687  
customer.service@gibitre.it

We reserve the right to make  
changes in design and speci-  
fications without further notice

[WWW.GIBITRE.IT](http://WWW.GIBITRE.IT)

WIKI\_2/19\_ENG