

Soil fertility management

Agrodok 2 - Soil fertility management

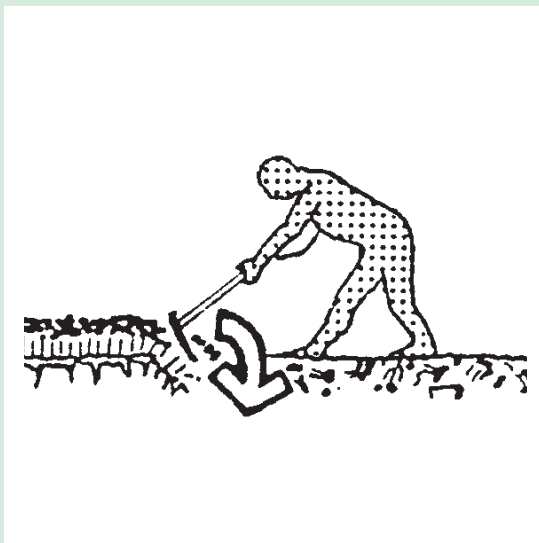
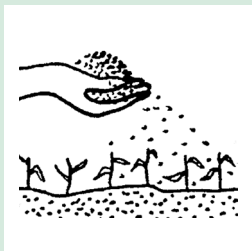

partageons les connaissances au profit des communautés rurales
sharing knowledge, improving rural livelihoods

Agrodok 2

Soil fertility management

Laura van Schöll
Rienke Nieuwenhuis

© Agromisa Foundation, Wageningen, 2007

All rights reserved. No part of this book may be reproduced in any form, by print, photocopy, microfilm or any other means, without written permission from the publisher.

First english edition: 1986

Third revised edition: 1998

Fourth edition: 2005

Fifth edition: 2007

Authors: Laura van Schöll, Rienke Nieuwenhuis

Illustrators: Barbera Oranje, Daniel van Buren

Translation: Catharina de Kat-Reynen

Printed by: Digigrafi, Wageningen, the Netherlands

ISBN Agromisa: 978-90-8573-031-6

Foreword

Special thanks go first and foremost to Rob Leijder, Stephan Mantel, and Jan Vlaar for their invaluable comments. Further thanks go to the illustrators, Barbera van Oranje and Daniel van Buren.

This Agrodok is a revised edition, which incorporates two previously published Agrodoks (Agrodok 2: ‘Soil Fertility’, and Agrodok 28: ‘Green Manures’). These were combined because they can’t be dealt with separately: green manures offer the small-scale farmer extra opportunities to improve soil fertility. In addition to animal manure and chemical fertiliser, crop husbandry measures, such as the use of green manure, are important in combatting soil fertility problems.

Agromisa publishes a whole series of Agrodoks. In addition to ordering Agrodoks, you can correspond directly with Agromisa’s Question and Answer Service to get advice about specific problems relating to agriculture.

Rienke Nieuwenhuis
Laura van Schöll
October 1998

Contents

1	Introduction	7
	Part I: Soil fertility and crop husbandry	10
2	Introduction	10
2.1	Crop husbandry measures	10
2.2	Organic matter	11
2.3	Burning	12
2.4	Local conditions	13
3	Mulching	15
3.1	Advantages of mulching	15
3.2	Disadvantages and limitations of mulching	16
3.3	Method and recommendations	17
4	Green manuring	18
4.1	Advantages of green manures	18
4.2	Disadvantages and limitations of green manures	19
4.3	Method and recommendations	20
5	Intercropping	22
5.1	Advantages of intercropping	22
5.2	Disadvantages of intercropping	23
5.3	Method and recommendations	24
6	Green fallow periods	25
6.1	Advantages of fallow periods	25
6.2	Disadvantages	25
6.3	Method and recommendations for green fallow periods	26
7	Agroforestry	27
7.1	Advantages of agroforestry	27
7.2	Disadvantages and limitations of agroforestry	28

7.3	Method and recommendations	28
7.4	Agroforestry systems in dry areas (arid and semi-arid)	28
7.5	Agroforestry systems in wet areas that have a chance of rain nearly throughout the year (sub-humid and humid areas)	30
Part II: Soil fertility and fertilising		35
8	Introduction and nutrient balance	35
9	Compost	36
9.1	Local conditions	36
9.2	Advantages of composting	37
9.3	Disadvantages and limitations of composting	37
9.4	Methods and recommendations	38
9.5	Important points regarding compost	40
10	Manure	42
10.1	Local conditions	42
10.2	Advantages of keeping and ageing manure	43
10.3	Disadvantages of keeping and aging manure, precautions to be taken	44
10.4	Methods and recommendations	44
11	Use of chemical fertiliser	48
11.1	Application methods	48
11.2	Types of chemical fertiliser	49
11.3	Timing and method of application per nutrient	50
11.4	Liming	52
Part III: Theoretical background		55
12	Plant nutrients	55
12.1	The macro-nutrients	56
13	Important soil characteristics	59

13.1	Soil structure	59
13.2	The solid soil particles	60
13.3	Aggregates	61
13.4	Organic matter in the soil	61
13.5	Soil organisms	63
13.6	Immobilization of nitrogen (N) and the C:N ratio	64
13.7	Chemical characteristics of the soil	65
14	Soil assessment	68
14.1	Soil texture and structure	68
14.2	Level of organic matter	71
14.3	Impermeable layers	71
14.4	Nutrient supply	72
	Appendix 1: A few important soil types in the tropics	75
	Further reading	78
	Useful addresses	80
	Glossary	81

1 Introduction

Agromisa receives many questions about agricultural problems that directly or indirectly involve soil fertility problems. Often crop returns have decreased, so farmers want to know how to regain previous harvest levels. Lack of soil fertility causes decreased yields but many plant diseases are also related to poor soil fertility. If the soil fertility is not good, the crops are not in optimal condition, and are thus more susceptible to diseases and pests. The presence of diseases and pests lowers productivity levels, again threatening further the livelihoods of the rural communities. Such conditions can be avoided by improving the condition of the soil.

The presence of organic matter in the soil is fundamental in maintaining the soil fertility. Organic matter in the soil consists of fresh organic matter (leftover of dead plants and animals) and humus. The fresh organic matter is transformed into humus by soil organisms. Humus gives the soil a dark colour and can retain a lot of water and nutrients.

This means that the first step in maintaining soil fertility should be directed at maintaining the organic matter content of the soil. This can be done by using appropriate crop husbandry practices and by applying organic manure or compost. If the soil is very deteriorated, applying chemical fertilisers might be necessary. Chemical fertilisers can restore the soil fertility very quickly; because the nutrients are available to the plants as soon as the fertilisers are dissolved in the soil. It takes much longer before organic matter is transformed into humus and has released its nutrients.

This Agrodok will provide information about appropriate crop husbandry practices and the use of organic and chemical fertilisers, and it will give some background information and definitions of terms that are often used in soil science. Finally, it will outline a procedure to assess the condition of the soil.

This Agrodox is divided accordingly into three parts:

Part I describes the appropriate crop husbandry practices to maintain and/or improve the condition of the soil.

Part II describes fertilisers that can be applied to achieve quicker results but at a higher cost: both organic and chemical fertilisers will be considered.

Part III explains some scientific terms that are often used in texts about soil science to help those who want to read more about soils. A procedure to assess the condition of the soil is also given here.

Part I Soil fertility and crop husbandry

After an introduction about crop husbandry, organic matter, burning and the local conditions the crop husbandry systems are described in more detail:

- mulching is a method, in which a layer fresh organic matter is placed on top of the soil;
- green manuring consists in ploughing under fresh green material;
- intercropping means growing two or more crops together on the same field;
- during green fallow periods, species are sown or stimulated that have better qualities than the species that would grow spontaneously in the fallow period;
- agroforestry comprises all forms of land use in which woody species (trees and shrubs) are grown in combination with other crops.

Part II Soil fertility and fertilisers

The use of animal manure and compost contributes to retaining the level of organic matter in the soil. Chemical fertiliser can be needed to quickly supply a crop with required nutrients. In contrast to organic fertilisers, chemical fertilisers help the plants immediately; organic manures first have to be broken down into nutrients before they can be utilised by the plants. This means that organic material only has an effect in the long term, while chemical fertilisers contribute immediately (within a few days to weeks) to soil fertility. However, chemical fertilisers are depleted by the end of the season or seasons, while organic matter continues to enhance soil fertility as well as the soil

structure. Moreover, the presence of organic material ensures that the chemical fertiliser is more efficiently utilised by the crop because it prevents the fertiliser from being leached. It is in fact a waste of money to apply chemical fertiliser on soil that is poor in organic matter if it is not done in combination with measures to increase the level of organic matter in the soil.

Part III Theoretical background

This section provides background information on technical terms, such as nutrients, and on important concepts in soil science, such as texture, structure, organic matter, soil organisms, aggregates, and chemical properties of the soil such as pH and CEC. These terms can also be found in the glossary (Appendix 2). In addition, Part III can be used as a preparatory resource for discussions with technicians or as an aid to understanding more technical literature.

A procedure to assess the condition of the soil is given: this includes assessing a number of important factors such as texture and structure of the soil, presence of impermeable layers, level of organic matter and soil life, the nutrient supply and the acidity of the soil.

A literature list is also included for those who seek more information on soil science problems.

Appendix 1 contains a list of a few important soil types in the tropics. Appendix 2 contains a glossary.

Part I: Soil fertility and crop husbandry

2 Introduction

2.1 Crop husbandry measures

Crop husbandry measures refer to methods the farmer can use before, during and after the growing season that do not require the addition of a new component to his business nor the purchase of many extra inputs (just sowing or planting materials). These measures include mulching, green manuring, intercropping, green fallow periods, and agroforestry.

All of the above methods are intended to achieve and retain optimum conditions in the root zone, where the crop gets the nutrients and moisture it needs for good production. Also the soil must be penetrable for plant roots. Methods such as mulching, intercropping and agroforestry aim to keep the soil covered in order to prevent evaporation and dehydration. Intercropping and agroforestry also ensure that extensive root systems are present in the soil; planting different crops with different root systems that need different nutrients contributes to a better utilisation of the available nutrients and water. The trees that form a part of agroforestry systems also ensure that the nutrients in deeper soil layers are utilised.

Green manuring and green fallow periods contribute particularly to a higher level of organic matter and to greater availability of the nutrients that are released from the organic material worked into the soil. The latter function can be intensified if leguminous plants are used.

2.2 Organic matter

Organic matter is very important in soil fertility management because it has many properties that help increase soil fertility and improve the soil structure. Organic matter has a great capacity to retain nutrients; this is especially important in sandy soils, which retain very few nutrients. Organic matter can also retain a lot of water, which means that in dry periods more water is available for the plants for a longer time. This is especially important in sandy soils, which retain little water. Organic matter can improve the soil structure. This is important for both sandy and clay soils, because they have a poor structure. Finally, organic matter stimulates the growth of soil organisms, which help make the nutrients in the organic matter available to the plants.

The organic matter in the soil consists of fresh organic material and humus. Fresh organic material is plant and animal waste that has not yet decomposed, such as roots, crop residues, animal excrement and cadavers. The fresh material is transformed by soil organisms into humus, which is also called organic soil matter. In the process, nutrients are released; organic matter thus makes nutrients available to the plants. Humus, i.e. organic soil matter, is material that has been broken down so far that the original fresh material is no longer distinguishable. It gives the soil a dark colour. Humus itself is also broken down by the soil organisms, which releases even more nutrients, but this process takes much longer.

Crop husbandry that contributes to a positive balance of organic matter is the basis for good soil fertility in the long term. The balance of organic matter must be even or positive, that is, the amount of organic matter that is added must be equal to or greater than the amount that is broken down and thereby lost. However a positive balance of organic matter is difficult to achieve. This means that if a lot of organic matter is lost (by erosion for example) it is difficult to increase the level of organic matter in the soil. Even in favorable conditions and with good crop management, this can take a number of decades, especially if during that time crops are grown that are almost completely removed with the harvest.

The rate at which organic matter is broken down depends largely on the climate. In warm, damp conditions the organic matter is broken down faster than in cold or dry conditions.

2.3 Burning

Burning vegetation to prepare land for cultivating crops is a common practice. The advantages are great, because burning fallow vegetation or crop residues with weeds saves a lot of labour. The fallow or weed vegetation is largely gone and no felling or cutting has to be done. The ash contains many nutrients in a directly usable form. The first harvest after burning fallow vegetation is usually a good one.

After a few seasons, however, a negative effect of burning can be seen in the level of nutrients and in the soil fertility. This has a number of causes. During the burn, large amounts of nitrogen (N) and sulphur (S) are released. These are thus no longer available for the plants (more information on the importance of these nutrients can be found in Part III, Chapter 12).

After burning, all the nutrients that were stored in the vegetation become available in the soil moisture, but they cannot be completely utilised all at once. In heavy rains, large amounts of N will be leached. Phosphate in mineral form becomes fixed to the soil particles and is then no longer available for the crop.

Regular burning of crop residues decreases the supply of fresh organic material and thus results in a decreased level of organic matter in the soil, which has negative long-term effects on soil fertility.

After the burns, the soil is unprotected and therefore susceptible to crust forming and to water and wind erosion. Ash is very light and is therefore easily carried away by wind and water. Along with the ash go the nutrients, leaving the soil without supplies for the next crop.

Since the soil is uncovered, the soil temperature during the day can become very high, which is unfavourable for soil organisms and for seed germination. The soil also dries out faster this way. As a result, the soil is hot, dry, and empty of soil organisms, rather than cool, humid, and rich in soil life, as the plants would like it to be.

2.4 Local conditions

In deciding which of the crop husbandry practices is the most effective, it is important to consider climate and possible slopes in the terrain. In humid areas that receive rain throughout the year, a living ground cover in the form of green manures is often better than mulch. A green manure takes in nutrients that the rain would otherwise wash away when no main crop is growing.

In sub-humid areas where it does not rain throughout the year and dry periods are clearly distinguishable, green manures can also be effective. However, in these areas competition with the main crop for water can become a problem. If the rainy season is so short that a green manure takes the place of a food or cash crop then the farmer will thereby lose food or income. A farmer will only do this if the green manure is so effective that it compensates for the loss by considerably increasing the yields of the following crops. The degree to which the yields are increased depends on the situation, so field trials must be done per region. It is important to remember that green manures save money by replacing chemical fertiliser, and they prevent the long-term loss of soil fertility (and thus income) by preventing erosion. These advantages are not always directly apparent. Mulch is a good alternative in sub-humid areas because it does not compete with the main crop. Intercropping is also often done because the water and nutrients are better utilised, it helps prevent erosion and it helps spread the risks of crop failure.

In semi-arid and dry savannah areas where the rainy season is very short, water is the most important limiting factor. Erosion by wind or water is a grave danger. Mulch is very important in these zones be-

cause it increases the moisture level in the soil by improving infiltration and preventing dehydration. The problem in these areas is how to obtain enough organic material to use as mulch. Intercropping is also used, especially as a way to spread risks. The yields of the various different crops together are not always higher than in a monoculture on the same area. This is because the plants in an intercropping system cannot be grown closer together than in a monoculture due to the shortage of water. Green manures are not suitable in dry areas because they require too much water.

In mountainous areas it is important to prevent erosion caused by water run-off. This is why it is so important to keep the soil covered as much as possible. In areas with enough rainfall, green manures and intercropping can be used, but in dryer areas mulching is a better alternative.

3 Mulching

Definition: Mulching means covering the ground with organic material, such as crop residues, straw or leaves, or with other materials such as plastic or gravel.

The goal of mulching is to:

- improve infiltration;
- protect the soil from water and wind erosion and from dehydration;
- prevent high ground temperatures;
- increase the moisture level in the soil;

and, when mulching with organic material, to:

- increase or retain the level of organic matter in the soil;
- better utilise the nutrients from chemical fertiliser;
- stimulate soil organisms.

3.1 Advantages of mulching

- Covering the ground with a mulch layer protects the soil from forming a crust. This allows the rainwater to infiltrate, and thus decreases water erosion. Moreover, the mulch layer protects the soil particles from being carried away by strong winds, i.e. it decreases wind erosion.
- The mulch layer protects the soil from becoming dehydrated. Together with increased infiltration, this ensures that the moisture content in the soil remains higher than in soil without a mulch layer. It will thus take longer in the dry season for crops with a mulch layer to be short of water.
- The temperature of exposed soil can become very high during the day. By applying a mulch layer, the sun is blocked and the daytime temperature is lower, which is favourable for seed germination, the crop's root growth, and for the growth of micro-organisms.
- The mulch layer prevents the phosphate in chemical fertilisers from getting into contact with the soil particles that fix the phosphate.

Phosphate fertilisers are therefore more effective if they are applied on top of a mulch layer than if they are applied on unprotected soil (Figure 1, see also Part II, Chapter 11).

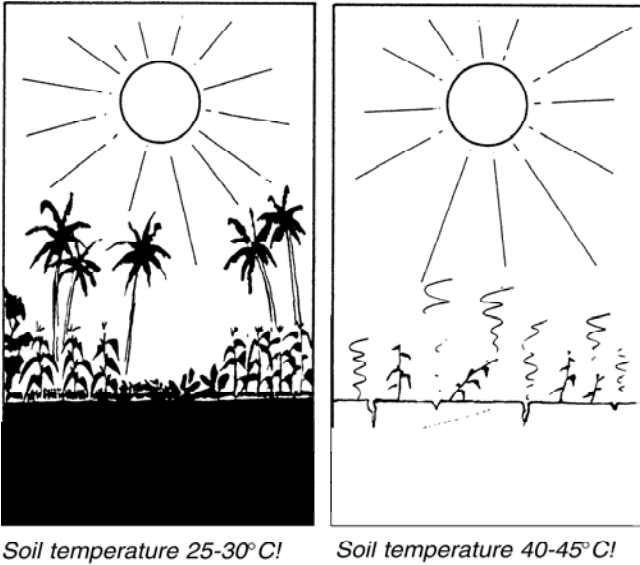

Figure 1: The difference between protected (left) and unprotected soil (right) (Source: Wijewardene & Waidyanatha, 1984).

An extra advantage of mulching with organic materials compared to mulching with non-organic materials is: the decomposition of the mulch increases the level of organic matter in the soil.

3.2 Disadvantages and limitations of mulching

- Some organisms in the soil can profit so much from the higher moisture content and protection from high temperatures that they proliferate under the mulch layer. Snails can multiply extremely quickly under a mulch layer. In sub-humid areas of Africa, mulching caused an increase in termites. The termites can harm the crops, coffee for example. In such circumstances, it would be better to look for an alternative, combining the use of compost (Part II,

Chapter 11) with specific steps to protect the soil from water and wind erosion (Agrodok 11: 'Erosion Control in the Tropics').

- The use of crop residues as mulch can intensify the risk of pests. This is especially true with the crop residues of corn, sorghum, sugar cane and cotton, particularly if they are not grown alternatively with another crop. Damaging organisms such as stem borers can survive in the stems and create problems the following season. This effect can be minimised by ploughing the crop residues into the soil, by allowing cattle to graze, by adding compost, or by rotating crops.

3.3 Method and recommendations

The mulch has to be applied before the rainy season begins, because the soil is then most vulnerable. The seeds can be sown through the mulch layer by making small openings in the mulch through which the seeds are planted. After planting each seed the opening must be closed, otherwise birds will become aware of the presence of the seed. The mulch layer may not be too thick. A sufficient amount would almost completely cover the soil from sight. If the layer is too thick, it will be difficult for the sprouted plants to reach the surface. The seeds can also be sown in rows that have been cleared by ploughing or removing the mulch.

4 Green manuring

Definition: Green manuring consists of ploughing in green, not woody plants or plant parts. The plant material can come from a crop that was grown after or between the main crop, or from a weed that grew during a fallow period. It can also come from a shade plant or tree whose cuttings or fallen leaves are suitable for ploughing into the soil.

The goals of green manuring are to:

- make nutrients available for the main crop;
- improve the soil structure;
- increase or retain the level of organic matter in the soil;
- increase the ability of the soil to retain moisture;
- protect the soil against rain and wind erosion, dehydration and extreme temperature fluctuations at a time when no other crops are present;

and, when using leguminous plants as green manure, to:

- fix extra nitrogen out of the air, which becomes available to the main crop after the manure has been ploughed into the soil.

4.1 Advantages of green manures

- During their growth period, green manures provide the same benefits as mulch. They are therefore sometimes called ‘living mulch’.
- Their advantage over mulch is that they absorb nutrients, so these cannot be leached during a period in which no main crops are grown. After the green manures are ploughed under, these nutrients become available via decomposition.
- Green manures also have a positive effect on the soil structure, because of the penetration of their root systems, they add organic matter, and they stimulate the growth of soil organisms. Organic matter nourishes the soil organisms, which also benefit from the higher moisture content and the limiting of extreme temperatures during the day.

4.2 Disadvantages and limitations of green manures

- If farmers are not accustomed to growing green manures, they may not readily accept the method. While the farmers have to invest their time and labour, they receive no obvious benefit, such as cash or food. The direct advantage in the form of increased production is not always immediately noticeable. Moreover, ploughing under a green manure is hard work, especially if done by hand.
- An alternative that is easier to introduce is intercropping (Chapter 5) with a green manure. The green manure is then grown in combination with the main crop (Figure 2). To prevent competition for nutrients, the green manure plant is sown later than the main crop. This is possible even in a short season, because the green manure plant does not have to mature fully. One plant that has been used quite successfully for this purpose is mucuna under corn.



Figure 2: Corn with green manuring (left).

4.3 Method and recommendations

- It is important to choose a plant species that quickly covers the ground and produces a deep and extensive root system, so that the nutrients from the deep soil layers can be transported to the surface. A fast groundcover also prevents the growth of weeds, because it shades them.
- However, the green manure may not grow so quickly and easily that it expands to other fields where a different crop is being grown. And it may not be so resilient that it continues to grow after it has been ploughed under.
- A few species that are often used as green manures are: *Crotolaria juncia* (sun hemp), *Sesbania aculeata* (daincha), *Vigna unguiculata* (cowpea), *Vigna mungo* (black gram), and *Vigna radiata* (green gram). If these species are not available, other species that grow well in the area can be used, as long as they satisfy the requirements listed above.

The green manures are usually ploughed under when they are still young and succulent. The material is then broken down quickly by the soil organisms, whereby the nutrients become available. Within a few months the material is completely decomposed. Thus, little addition is made to the level of organic matter in the soil. Young and succulent material should be ploughed under at least two months before the new crop is sown, because in the initial period of decomposition, substances are released that can damage the young sprouted plants or can make the root ends sensitive to damage by pathogens.

If the material is ploughed under when it is older and tougher it will be broken down much slower. In that case it does add to the level of organic matter in the soil. Since the nutrients are slowly made available, their effect in the first season is less than with young and succulent material. However, the effect is noticeable for several seasons.

If the soil has a low organic content, it is better to let the green manure get old and tough, so that an addition is made to the level of organic matter in the soil. The level of organic matter in the soil is after all the

most important indicator of soil fertility. Material that is old and tough generally is difficult to decompose. Many soil organisms are needed to do this. Before the soil organisms can start to digest the organic matter they have to grow themselves. To grow the organisms use nitrogen like plants do (this is also called nitrogen immobilisation). This means that if plants grow at the same time as the organisms the plants will lack nitrogen. Therefore it is better to first allow the soil organisms to grow and decompose the organic matter before the crop is sown.

So the green manure must be ploughed under 5-6 weeks before the main crop is sown.

5 Intercropping

Definition: Intercropping means growing two or more crops together on the same field. By combining crops that have different growth patterns, the available air, water and nutrients can be better utilised.

Important goals of intercropping are:

- 1 a direct production increase compared to monoculture (if enough water is available), due to:
 - better ground cover;
 - optimum use of sunlight;
 - more efficient root growth;
 - extra nitrogen (when using nitrogen-fixers);
- 2 spreading the risks of crop failure over more crops, due to:
 - multiple crops; if one crop fails the other might still yield something;
 - limited effect of diseases and pests because one pest or disease is mostly specialised on one crop and will leave a different crop unharmed.

5.1 Advantages of intercropping

- In many parts of Africa intercropping is a traditional farming method. A common combination is a grain crop grown together with a bean crop. Grains generally grow tall and slender, while beans stay low and creep over the ground. This combination protects the soil more than a single grain crop would. Grains generally need as much sun as possible, while beans and other legumes grow just as well in the shade. The available sunlight can thus be utilised optimally by both crops.
- If one of the crops fails, for example due to irregular rainfall or disease, then the other crop can often still provide a successful harvest. In this way, the farmer minimises the risks of crop failure.

- With multiple crops, each with its own root pattern, water and nutrients can be absorbed from various layers and places. These resources are thus utilised more efficiently than when only one crop is grown (Figure 3).

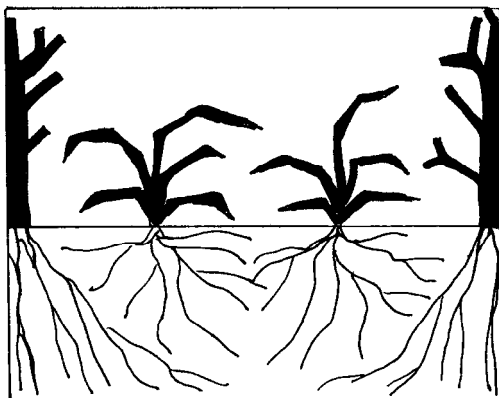

Figure 3: Crops with various root systems (Source: V. Noordwijk, 1990).

- Intercropping can have a limiting effect on the spread of diseases and pests. For example, grains can serve as a barrier against the spread of insects in cowpea or peanut crops.
- Insects or other pests that damage a particular crop can be driven away by substances that another crop produces, or by the other crop's attraction of insects that eat the damaging soil organisms or insects. This method is especially used in the cultivation of vegetables, such as by planting onions and carrots next to each other.
- Lack of labour is often a problem at peak seasons such as sowing and harvesting time. If the sowing and harvesting periods of the different crops vary, it is easier to spread the available labour over the entire season avoiding high peaks.

5.2 Disadvantages of intercropping

- One disadvantage is that the denseness of the crops makes it physically more difficult to combat diseases, pests and weeds.
- Mechanisation of an intercropping system is difficult to achieve. However, this is generally not a very serious problem because small farmers perform most tasks by hand.

5.3 Method and recommendations

- A frequently used combination is that of a grain with a bean. Beans are nitrogen fixing crops i.e. they can fix extra nitrogen from the air. They are also good at releasing fixed phosphate. The timing of the sowing dates of the different crops in relation to each other is important, because if the nitrogen-fixer matures and is harvested first, then the added nitrogen and phosphate already become partially available to the other crop. If it matures after the other crop, then the nitrogen and phosphate will only be available to the subsequent crop.
- Whether diseases and pests are stimulated or, preferably, blocked by intercropping depends on the crops, the climate and also on which diseases and pests are common in the area. Therefore, it is best to first experiment on a small scale.
- If farmers have very serious objections to growing various crops together on one field, then crop rotation is an option. In this case various crops are grown one after the other on one field. By choosing crops that have different root patterns and that do not contract the same diseases, some of the advantages of intercropping can still be achieved.

6 Green fallow periods

Definition: In a green fallow period, species are sown or favoured that have better qualities than the species that would normally grow spontaneously in the fallow period. The goal of green fallow is to quickly restore soil fertility. Traditionally, fallow periods are used to restore the soil fertility after a period of crop cultivation, and to suppress the growth of weeds that commonly grow between crops. Many of these types of weeds cannot compete with the weeds that grow during the fallow period. If farmers have too little land available, fallow periods can become too short to restore the soil fertility. This is often the case in the transition from a shifting cultivation system to a permanent system.

6.1 Advantages of fallow periods

The advantage of a green fallow period is that the restoration of soil fertility will take place faster.

Fallow periods can be shorter, which is especially advantageous in areas where the pressure on land is intense.

6.2 Disadvantages

Farmers will have to invest time and money sowing species that may not yield them any cash income. (There are some leguminous crops such as pigeon peas, which do meet the characteristics below and can be sold as well).

6.3 Method and recommendations for green fallow periods

The method consists of stimulating or sowing species that have the following characteristics:

- fast ground cover;
- high biomass production;
- nitrogen fixation;
- development of extensive and deep root system;
- no danger of spreading to nearby fields, for example due to flying seeds;
- easy to plough under;
- preferably: usable production (fruit, stakes, medicine, food).

These plants can be sown or planted before or during the harvest of the main crop, in the spontaneous fallow vegetation, or in a first on a bed/nursery and then transplanted into field. All species that fulfil the above requirements are suitable for this purpose. *Mucuna utilis* is a popular species because it helps suppress *Imperata (satintail)* in the fallow period.

Another possibility is to tolerate the growth of certain species that appear while the main crop is growing, and to let these mature after the main crop has been harvested. Favourable results have been achieved in this way with palm trees. During the fallow period they can mature completely and provide income in the form of palm wine.

7 Agroforestry

Definition: Agroforestry comprises all forms of land use in which woody species (trees and bushes) are grown in combination with other vegetation or animals.

The most important goals are to:

- prevent the loss of nutrients;
- provide protection from wind and water erosion;
- provide organic mulch material;
- produce valuable products;
- make the environment more suitable for livestock.

7.1 Advantages of agroforestry

- Cultivating woody species together with other crops reduces nutrient loss. Trees and bushes generally have highly developed root systems, which can absorb many nutrients that are lost to crops with shallow root systems. The nutrients are ‘stored’ in the woody species. In this way they are protected from being leached in periods when no other crops are cultivated. After the leaves or cuttings fall to the ground, the nutrients once again become available to the crops via decomposition. This effect of woody species is sometimes called a ‘nutrient pump’.
- Trees and shrubs can form hedges that protect crops and soil from wind and the water of heavy rains running off over the surface of the soil.
- Leaves and cuttings can serve as mulch.
- If trees are planted, it becomes easier to obtain certain products. Fruit trees provide a valuable addition to the diet, the leaves or fruit from trees can be fed to livestock, and the wood can be used for firewood. Some woody species contain substances that can serve as medicine. If the trees are older they can also be used as lumber.

- Livestock can also profit from trees planted in pastureland. The trees provide shade and a lower temperature, so the animals perspire less and require less water to drink.

7.2 Disadvantages and limitations of agroforestry

As mentioned above, woody species have large root systems. This can lead to competition for water and nutrients between the crop and the trees or shrubs.

7.3 Method and recommendations

There are many possible ways to combine woody species with crops or livestock. A number of possibilities will be described below. It is often not possible to implement an example exactly as described. However, to prevent competition with the main crop, it is extremely important to regularly prune the trees or bushes and to thin out their roots by trimming them to one half metre around. Try to implement systems whose advantages best fit your circumstances. The use of trees for firewood, for example, can be more important than their provision of mulch. Try to adapt the example to your situation, such as using trees that already grow in your area, and that provide the same advantages. Pay attention to climatic conditions; some systems work well only in certain climates.

7.4 Agroforestry systems in dry areas (arid and semi-arid)

The use of *Acacia albida* in fields and pasturelands

Acacia albida is commonly used in semi-arid areas of West Africa. *Acacia* is a large tree, whose leaves provide shade for cattle in the dry season, and fall at the beginning of the rainy season. This pattern prevents competition with the main crop for light, water and nutrients.

Acacia increases soil fertility by providing:

- organic matter in its leaves;
- nitrogen fixation;
- a nutrient pump in its extensive root system;
- shade for cattle in the dry season (whose dung also enhances soil fertility).

Acacia provides feed for cattle in the form of fruits (a substantial quantity: the fruits from ten trees is comparable to the harvest of hectares of barley), leaves and young shoots.

Wind breaks

In semi-arid and arid areas strong winds can sweep away large portions of topsoil. This topsoil holds the most fertile particles of the soil, to a large extent from applied chemical fertiliser, and after sowing, the sowing seed. Wind breaks in the form of rows of trees or shrubs can decrease this loss. The rows literally lift the wind, so that there is less wind behind them. Some wind still blows through the row, but its force is reduced and fewer soil particles can be swept away by it. Since there is less wind, the humidity in the air stays higher and less moisture evaporates from the soil and crops. This is especially important in dry areas that have a shortage of water.

The wind breaks can never be air tight, because the wind would then fall behind them, creating strong circular currents (Figure 4). Walls and wooden or plastic breaks are therefore less effective.

Living fences

Trees and shrubs can be used as living fences. Fast-growing trees can be planted at some distance from each other and thus serve as fence posts between which barbed wire can be strung. At the same time they can provide cattle feed, firewood, green manure, or mulch. Leguminous plants are especially suitable. A hedge of dense shrubs can fence off a piece of land or surround a field of vegetables. Moreover, if a hedge of thorny shrubs is used, it is impenetrable for animals. It is preferable to use a species that can also provide a product such as cattle feed, fruit or firewood.

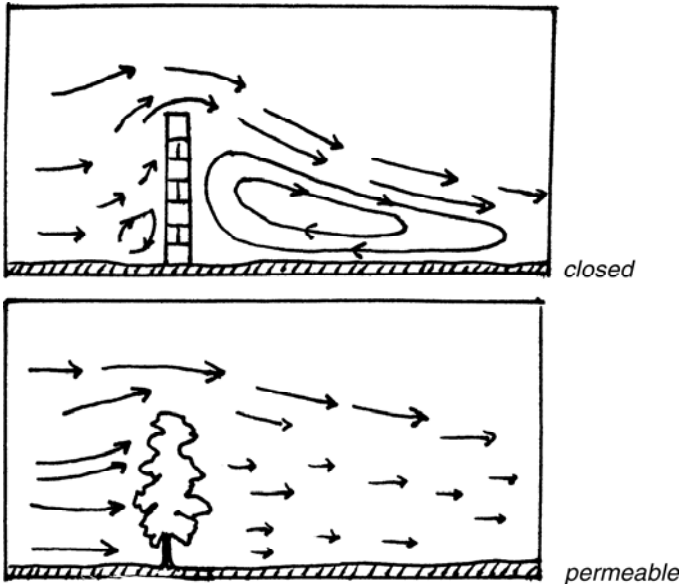

Figure 4: Example of wind breaks and effect of wind turbulence.

7.5 Agroforestry systems in wet areas that have a chance of rain nearly throughout the year (sub-humid and humid areas)

Living fences

Living fences can be used in these areas in the same way as they are used in arid areas (see above). Moreover, in wet areas dense hedges of shrubs can be used to separate fields. Competition for water between the main crop and the shrubs is not an issue in sub-humid and humid areas. The shrubs can also provide mulch, firewood or cattle feed.

Shade trees on plantations

Crops such as coffee, tea, vanilla, cardamom, and peppers prefer to grow in some shade rather than in the full sun. In many areas it is therefore customary to plant shade trees between dense plantings of these crops. The amount of shade provided depends on the space between the trees, the form of the leaves, the density of the crown and the height of the trees. In addition to shade, the trees provide products such as lumber, firewood and in some cases cattle feed.

Due to the usually abundant volume of fallen leaves, the soil is enhanced with the addition of organic material, which can remain on the ground to function as mulch. Nitrogen-fixers also provide an extra amount of nitrogen.

Shade trees are not suitable for areas that have little rainfall, because competition for water between the crop and the shade trees occurs. A few commonly used trees are: *Albizzia* varieties, *Acacia*, *Leucaena glauca*, *Glyricidia*, *Erythrina* varieties, *Sesbania grandiflora*, *Prosopis*, and *Cassia*.

Groundcovers on plantations

In plantations of young or sparsely planted rubber, oil palm, coffee, tea and cocoa, nitrogen-fixing groundcovers play an important role in erosion control. They protect the soil from the impact of raindrops and from dehydration, and they add organic material and nutrients.

In fields of young oil palm and rubber, the creeping species *Centrosema pubescens*, *Pueraria phaseoloides* and *Calopogonium mucunoides* are often used. However, their use is objectionable in fields of young coffee, tea and cocoa trees, which stand much closer together, because the shoots of the creeping nitrogen-fixers can climb on the trunks of the young trees. Therefore, it is more suitable to obtain a mulch layer from hedges comprised of *Crotalaria* and *Tephrosia* types and *Leucaena glauca* with *Flemingia congesta*. The hedges are trimmed just before the dry season, so that their cuttings can serve as mulch. By trimming the hedges just before the dry season, competition for water during that time is minimised. If the hedges are trimmed

too short (to less than 20 cm), they take a long time to recover, which reduces the production of mulch.

Bananas in tree nurseries

Many plantations and fruit trees are not sown directly in the field, but are sown first in a central location, where it is easier to maintain them. The trees are sown in bags of fertile soil, often between sparsely planted banana trees or plane trees. These trees can shade the young sprouts, and they provide income in a period when the new trees are not yet productive. By placing the bags close together they also protect the ground from the impact of raindrops and from dehydration.

Alley cropping or hedgerow systems

Figure 5:

- In alley (or hedgerow) cropping, annual crops are sown in lanes that are formed by rows of perennials. The goal of this system is to preserve the soil fertility if the fallow periods (as in shifting cultivation) become increasingly shorter or are discontinued altogether.
- The perennials are planted in parallel rows, with a distance of 2-4 m between the rows and 0.5 m between the plants. At the beginning of the rainy season the trees are pruned to a height of 0.5 to 1 m. The twigs and leaves are laid in the lanes as mulch, the branches are used as firewood or stakes. The crops are sown in the lanes through the mulch layer. During the growing season the trees have to be pruned regularly, to prevent them from shading the crop. For trees that quickly produce shoots, a height of 0.5 m is best; trees that grow slower can be pruned higher. The leaves can be applied to the crop as 'top-dressing', or they can be fed to cattle. After the crop has been harvested, the trees' shoots can be allowed to grow, so that the trees can provide enough shade to inhibit weed growth.
- When yams are cultivated as crops they can climb on the stalks of the perennials, which saves the effort of tying them up.

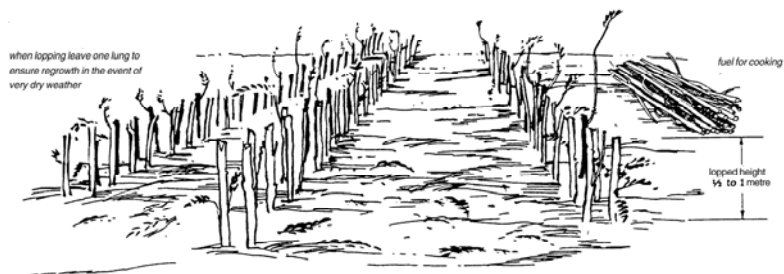
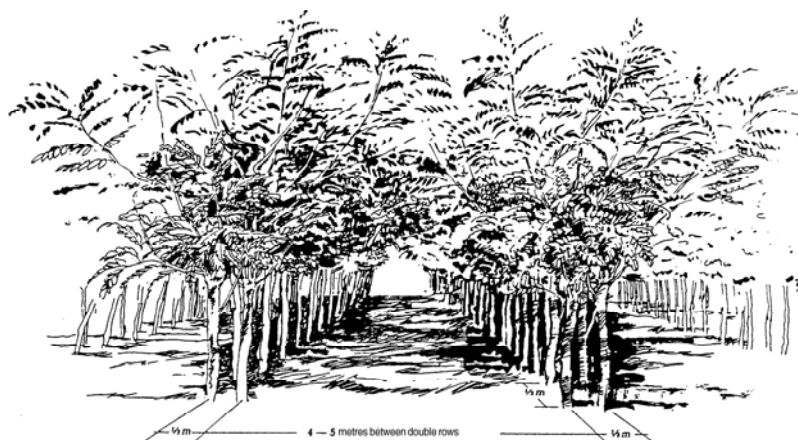

Figure 5: Alley cropping (Source: Wijewardena & Waidyanatha, 1984).

The perennials in the hedge must fulfil the following requirements. They must:

- be easy to establish;
- be fast-growing;
- produce biomass;
- withstand frequent pruning;
- be nitrogen-fixing crops;
- have deep root systems (starting with seeds rather than cuttings is preferable, because the directly sown plants develop deeper root systems and are more resistant to termites).

Advantages

- The most important advantages of this system are that the crop is supplied with nitrogen, and the level of organic matter in the soil is increased.
- Another advantage is the suppression of weeds by shade in the dry season, and by twigs and leaves in the growing season. Water erosion is also prevented.

Disadvantages/observations

- This system is very labour intensive. If the trees are neglected (not pruned on time), then crop production will often be lower.
- In steeply sloping areas, the hedges must follow the contour lines of the land. Twigs, weeds and other material that wash downhill get stuck on the bottom of the tree trunks, creating an accumulation of organic material that eventually forms terraces. In this way erosion is prevented.

Part II: Soil fertility and fertilising

8 Introduction and nutrient balance

To ensure a sufficient nutrient supply for crops, we must strive to keep an even nutrient balance in the soil. The loss of nutrients has to be minimised, and the addition of nutrients maximised in order to avoid a depletion of nutrients in the soil. (For more information on the function of the nutrients, see Part III, Chapter 13).

Nutrients can be lost in the following processes:

- removal of the harvest (all of the nutrients);
- volatilisation (especially N; this happens especially during burns due to the high temperatures);
- run-off (especially N);
- fixation (especially P);
- leaching;
- erosion (all nutrients).

Nutrients are added in the following processes:

- decomposition of organic matter (all nutrients);
- nitrogen fixation (only N);
- weathering (mostly K and Mg);
- chemical fertiliser (mostly N, P, and K);
- rain and solid matter deposits.

The removal of nutrients with the harvest is unavoidable. The higher the yield, the greater the removal. In addition to the net removal of nutrients, attention must be paid to the balance of organic matter, as described in Part I, Chapter 2.

9 Compost

(See also Agrodok 8: 'Preparation and Use of Compost')

Definition: Like manure, compost is an ideal fertiliser. To create a compost heap, organic material (e.g. crop residues, straw, manure, kitchen wastes, etc.) is collected and stored together. In this heap micro-organisms decompose the material.

Goal: After it is spread onto a field the compost supplies nutrients and increases the level of organic matter in the soil.

9.1 Local conditions

In areas with heavy rainfall, mulches and green manures are usually used together with permanent crops. Decomposition occurs fast enough on the field. So it is not worth the effort of composting crop residues. However, composting is very suitable for dryer areas where crop residues decompose very slowly in the field. In this situation composting provides greater yields for the farmer. In very dry areas composting can be difficult because water and organic material are scarce. The organic material that is available is also often used as cooking fuel. Compost is still a good alternative to mulching, which is unpopular in these areas because it often results in an invasion of termites. Compost also gives better results than chemical fertiliser due to its richer and chemically more balanced composition. Besides its chemical composition this is because compost increases the water retention capacity of the soil and it improves the soil structure. If there are clearly defined rainy seasons and dry seasons, then composting can be done at the beginning of the rainy season in prepared composting sites. Spreading the material before composting allows it to get thoroughly wet first. Planting fast-growing trees for firewood also provides organic material for composting.

9.2 Advantages of composting

Compost increases the level of organic matter in the soil, which has a positive effect on the soil organisms, soil structure, infiltration, water retention capacity and aggregate stability. Compost is rich in nutrients that are readily available to the plants.

Advantages of compost over mulch or green manures:

- Through composting, diseases and pests, as well as weed seeds are destroyed because the temperature in the compost heap is so high that they cannot survive.
- Rats and mice can nest in thick layers of leaves or mulch. This is not a problem with compost.
- If green manures are ploughed into the soil in climates that have a heavy rainy season, the mineralised nitrogen can be leached or volatilised (denitrification).
- Some materials have a very high C:N ratio, which can result in the immobilisation of nitrogen. After composting, the C:N ratio is decreased and the rough material is largely decomposed.
- Nutrients and organic material are lost when crop residues or fallow vegetation are burned. The positive effects of the ash often last only one season. By composting the material the nutrients and the organic matter is preserved and the positive effects last much longer.

9.3 Disadvantages and limitations of composting

- Composting is labour-intensive. If labour is in short supply, this can be an important limiting factor. On the other hand, compost is such a valuable fertiliser that it makes the invested labour very cost-effective. The compost heap can also be made in a period when there is not very much other work to be done.
- Another limitation can be that organic material is scarce, or it is used for cooking fuel. This can be solved by planting trees for firewood, for example as a living fence (Part I, Chapter 7). Composting without manure is very difficult, but it is possible.

- A compost heap can attract vermin, especially if kitchen scraps are also used. It can also stink. This need not be a problem if the heap is kept in the field instead of in the farmyard.

9.4 Methods and recommendations

The compost heap according to the Indore method

The Indore compost heap is built on a foundation of branches and twigs (Figure 6). This layer, which should be 10–20 cm thick, ensures that the heap gets enough air, ventilation and drainage. The following layers are added on top of this foundation:

- raw plant material (10–15 cm);
- wilted moist material (7-8 cm);
- manure (5 cm).

These layers are wetted and then sprinkled with a mixture of urine, earth, and finely ground charcoal or ash. This process is repeated seven times until the compost heap is 1.3 to 1.5 metres high. Then the heap is covered with a layer of earth. Thin sticks are pushed deep into the heap, down to the second layer. By turning these sticks air holes are made for ventilation. After two weeks the whole heap must be turned over, layer by layer. Material closer to the outside has to be placed closer to the centre. Again ventilation shafts are made. After two weeks the heap is turned over again in the same manner. After three months the compost is aged and ready to be used on the land.

If one of the above materials is not available, the compost heap can still be made with the other materials, but the time it takes for it to age will be different. Turning over the heap always promotes decomposition: the more the heap is turned over, the faster the material will decompose. But you must wait a few days each time before turning over the material again to allow the heap to reach a good temperature.

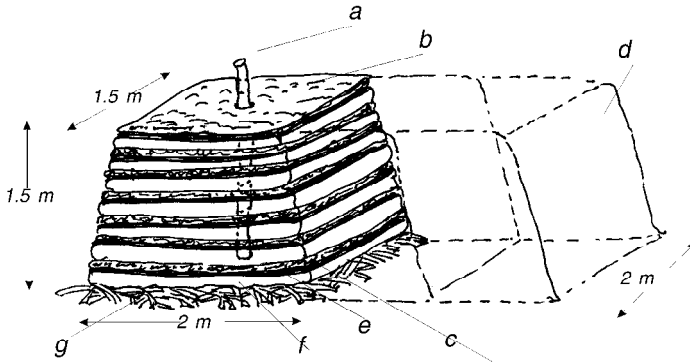

- a: ventilation post*
b: covering of earth
c: dung, urine and earth
d: space in which to turn heap/build next section
e: young and succulent plant material (nitrogen-rich)
f: old and tough, coarse plant material (carbon-rich)
g: twigs and branches

Figure 6: The structure of an Indore compost heap (Source: Müller-Sämman & Kotschi, 1994).

Fresh moist material decomposes easily. Old and tough material like straw and wood is more difficult to break down. The greater the proportion of the latter material in the heap, the longer it will take for the compost heap to be ready. Animal manure also has a positive effect; without it, decomposition progresses much slower.

The exact ratio of C:N in the compost heap is very important. As a rule of thumb, a ratio of 1 part manure to three parts plant waste, or one part old plant material to one part young material is preferred. A C:N ratio that is too low results in a loss of nitrogen in the form of ammonia (smells like cat urine). This can be remedied by adding earth or sawdust. If the C:N ratio is too high, the temperature in the heap will be low and decomposition will be very slow. The best method is to use various materials, of which no more than 10% should be rough material (branches, twigs, stems, etc.). It is always better to prepare this type of material beforehand, for example, by soaking it overnight or by using it in the stable. If the cattle lay on it for one night it can

also absorb urine which aids decomposition. In any case, the rough material has to be cut into small pieces (less than 20 cm) before it is added to the heap.

9.5 Important points regarding compost

Moisture level

The compost heap must be kept relatively moist. It should feel like a wet sponge. It should not be too wet, because it will then rot rather than decompose. In a heap that is too dry, the bacteria and fungi cannot develop sufficiently. The right moisture level can usually be obtained by thoroughly wetting all the material before starting the heap. The heap should be placed in the shade or under a shed to prevent it from drying out. A shed is best because it also prevents nutrients from being leached by heavy rainfall. In dry areas, or in the dry season, the heap can be started in a hole that is 60-70 cm deep, which will help keep it moist. This does not work in wet areas or in the rainy season, because any excess water cannot run off and the compost can become too wet on the bottom.

Ventilation

The bacteria and fungi need oxygen to develop and to breathe. Proper ventilation can be achieved by mixing fine and rough materials. Every point in the heap should be within 70 cm of a ventilation point. Turning over also allows air to enter.

Temperature

The temperature in the middle of a well-built heap becomes 60-70°C in the first days after construction or turning over. To achieve this temperature, the heap has to be at least a metre wide and a metre high. However, the heap should not be higher than 1.5 m, or wider than 2.5 m, because the temperature can then become too high. It is also difficult to properly ventilate large heaps.

Hygiene

In theory, all organic material can be used for compost. However, human excrement requires careful treatment to ensure that any diseases and viruses that could be present are completely destroyed. To begin with, it is helpful to add some earth, old compost or another material that stimulates the growth of micro-organisms such as manure and molasses. Lime or ash can also help well, if they are very finely ground and added in small amounts.

10 Manure

Definition: Manure consists of animal excrement, usually mixed with straw or leaves. The amount and quality of the excrement depend on the animals' feed. Good manure contains more than just excrement and urine. Straw and leaves are added and it is aged. Ageing is necessary to retain all of the nutrients. Using aged manure is an ideal method to retain and increase soil fertility.

The goals of applying manure are to:

- increase the level of organic matter;
- increase the available nutrients;
- improve the structure (aggregate formation) and water retention capacity of the soil.

The nutrients from animal feed are partly stored in the animals' bodies. By spreading their excrement and urine onto a field these nutrients are made available to the plants. The manure adds organic matter to the soil, thereby improving the soil's structure and its capacity to retain water. Soil organisms are also stimulated, which improves the soil structure.

If cattle graze freely they can gather their own food, and their excrement is thus spread randomly over the field. A great deal of nitrogen is then leached or volatilised. Potassium is also partially leached. To use the excrement as manure it is thus better to keep the animals in a stable. The nutrients in the manure can then be protected from being leached and lost.

10.1 Local conditions

In areas with heavy rainfall (the humid tropics) farmers often do not have enough cattle to produce sufficient amounts of manure. However, good alternatives are available in the form of green manures, intensive fallow periods and agro-forestry.

In areas with less rain and a dry season (sub-humid areas), conditions are better for raising cattle and less manure is needed for a substantial improvement of the soil fertility, because the organic matter decomposes slower.

In semi-arid and arid areas it is more difficult to keep the animals in a stable, because feed is scarce, and it is not possible to grow the feed. One option in this situation is to allow the animals to graze during the day, and to keep them in the stable at night. The manure is then kept in a manure cone to keep it from drying out too fast.

10.2 Advantages of keeping and ageing manure

Fresh stable manure is not very suitable for immediate use. The C:N ratio of fresh manure is high, which can cause nitrogen immobilisation. If the organic matter is very rough i.e. it contains a lot of fibre and few fresh, juicy leaves then the C:N ratio is high. Micro-organisms then have to work hard to digest it and allow nutrients to become available to the crops. Moreover the micro-organisms use nutrients to build up their own bodies which may exceed temporarily the amount they can generate. (For more information see Part III, Chapter 13). Also, in the initial stage of decomposition, substances are freed that can inhibit plant growth or scorch the leaves. If the manure is spread on a field empty of crops, many nutrients will be leached. Often there is not even a field immediately available where manure could be spread.

Keeping and ageing the manure has a number of advantages:

- The C:N ratio decreases during ageing.
- Harmful substances that are released in the first stage of decomposition are eliminated.
- Weed seeds are decomposed or lose their germinative power.
- Few nutrients are lost through run-off or volatilisation.
- Aged manure is easier to transport.

10.3 Disadvantages of keeping and aging manure, precautions to be taken

Despite the fact that aged manure is an ideal fertiliser with soil-improving characteristics, it is not always used on the land. In areas with limited fuel sources, dried manure is used as a cooking fuel. An alternative fuel source can be created by planting trees for firewood as living fences (Part I, Chapter 7) or along paths. Working with manure can also be seen as dirty and inferior, and manure piles as too unhygienic to have near the farmyard.

If a farmer's cattle normally graze freely, then keeping the animals in a stable will require the extra labour of gathering straw and cleaning out the stable. Sometimes an alternative can be to allow the cattle to graze on crop residues after the harvest, and to gather some manure from the field afterward. Transporting manure to the field is also labour intensive. So the manure is often brought to the field at a time that is relatively labour-free, like before sowing. However, if the manure is then immediately spread onto the field, the ground can be too dry to properly mix with it and nutrients can be lost. It is better in this case to keep the manure in a pile at the field and to mix it with the soil just before sowing. This way the nutrients will not be leached or volatilised.

10.4 Methods and recommendations

There are a number of different ways to keep manure and to allow it to age. Three of them are discussed below.

Loose box

Keeping the animals in a stable can make high quality manure. The roofs of the stable can serve as protection from rain and sun.

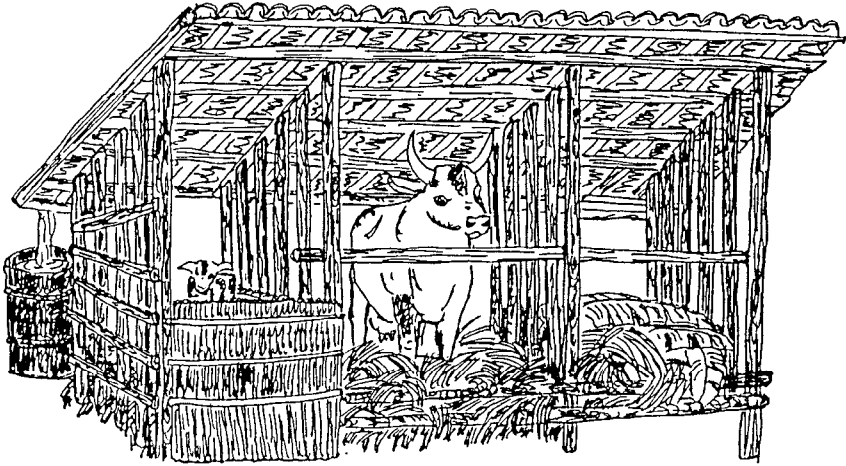

Figure 7: Loose box in Nyabisindu, Rwanda (Source: Müller-Sämamann & Kotschi, 1994).

Every day fresh straw or leaves are thrown into the stable. The animals stamp the straw into the manure. The straw or leaves also absorb the urine and nutrients. Enough material has to be added to ensure that the mixture does not become soggy. The loose box manure can eventually reach a height of 2 metres, and it is sufficiently aged after 3 or 4 months. Since the layers are not equally aged, the pile must be mixed thoroughly before it is applied to a field. This method requires a large amount of straw or leaves (Figure 7).

Manure pile

Less straw or leaves is needed if the stable is cleaned every two days. The manure is then used to make a manure pile, which is 2 metres wide and walled in (Figure 8). The pile is built in stages. One piece is piled up as quickly as possible to a height of 1.5 to 2 metres. It is then covered with earth to prevent it from drying out. Each time one piece is completed a new piece is started, and the pile continues to grow longer. Since a new piece is added on each time, aged manure from one end can be used at the same time that new manure is added at the other end.

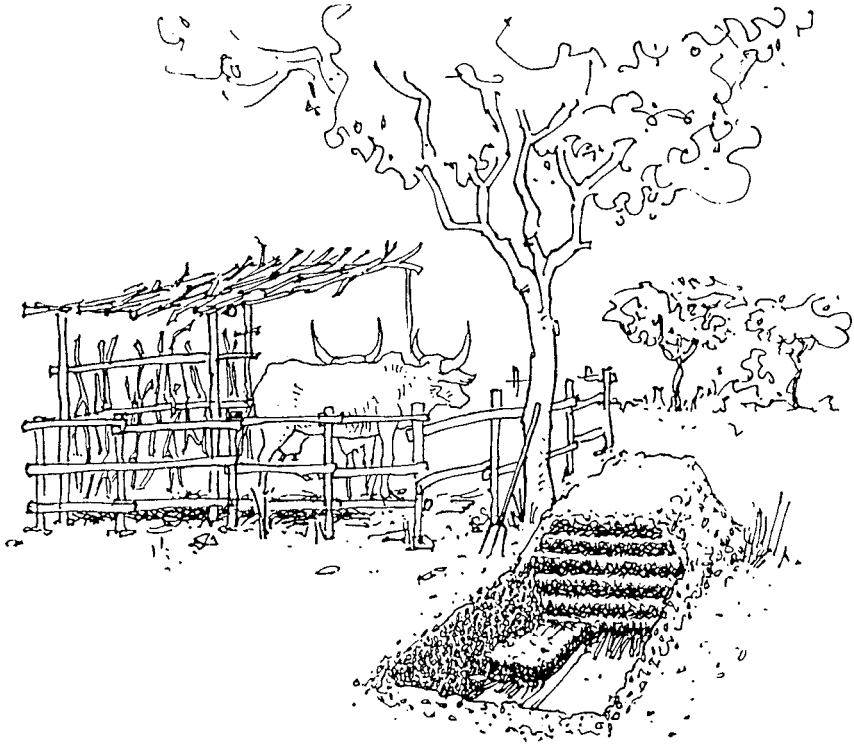

Figure 8: Manure pile with its layers and pieces (Adapted from (Müller-Sämann & Kotschi, 1994).

The manure must be well compacted, especially if it is very loose, and it must be kept moist. If the pile is too dry, white mould will appear; if it is too wet it takes on a yellowish-green colour. A good manure pile has a consistent brown or black colour. A manure pile should be situated under a shed so that it is protected from rain and from drying out. Ideally it should be on sloping ground so that excess moisture can drain off. Manure piles are especially suitable in wet areas or during rainy seasons.

Manure cone

Manure in semi-arid and arid areas contains less straw, which hinders the ageing process. An alternative that is suited to these areas is the manure cone. The manure cone begins as a circle with a diameter of 1.5 to 2 metres. Every day a layer of manure is added that is preferably 30 cm thick. Each layer has a smaller diameter. At a height of 1.5 metres the point is rounded off. The side surface is covered with a layer of clay, and the top is covered with a layer of straw or rough leaves to protect the cone from rain and drying out. After 4 or 5 months the manure in the cone is ready to use (Figure 9).

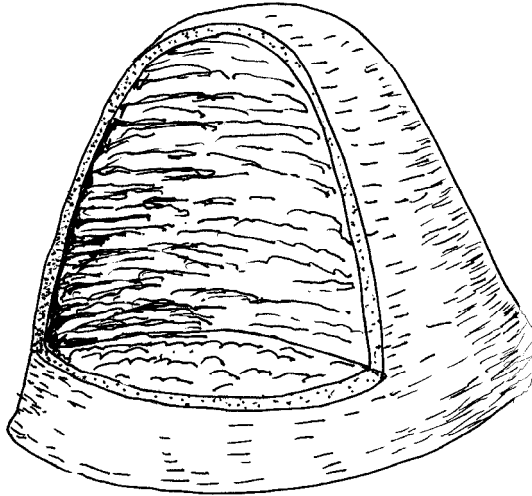

Figure 9: Manure cone (Barbera Oranje).

11 Use of chemical fertiliser

Nutrients can be directly added by the application of chemical fertiliser to the soil. However, the addition of chemical fertiliser alone is not enough to retain a sufficient level of soil fertility. If the organic matter in the soil decreases, the yield will also decrease, even if a lot of fertiliser is applied. This is due to degradation in the soil structure, a decreased capacity to retain nutrients and water, and an increase in acidity. For weathered, nutrient-poor soils in the tropics it is apparently not enough to increase the level of organic matter. In such areas it is preferable to use an integral approach that combines the application of chemical fertiliser with an increase in the level of organic matter.

11.1 Application methods

Chemical fertiliser can be applied in a number of ways:

- **Broadcasting:** the fertiliser pellets are spread evenly over the whole field, and then often ploughed or raked into the soil.
- **Row application:** the fertiliser is applied in rows, right next to or under the seeds.

If chemical fertiliser is applied once the crop has begun to grow, we call this top dressing. Top dressing can also be in the form of broadcasting or row application. Broadcasting is usually done on crops that are sown close together over a large area, and for mature fruit trees.

Row application is often used for crops that are grown in rows, or when little chemical fertiliser is available for infertile land. The chemical fertiliser must be placed at least 5 cm away from the seeds, because it would otherwise scorch the seeds or young roots. This scorching can be seen, for example, if you spread chemical fertiliser on (moist) young leaves.

11.2 Types of chemical fertiliser

There are many types of chemical fertilisers. Some commonly used types and their nutrient content are shown in Table 1. For example, 100 kg of urea contains 45 kg of nitrogen (N). The other 55 kg is filling. Di-ammonium phosphate contains 21 kg of nitrogen and 23 kg of phosphorus per 100 kg of fertiliser. So 100 kg of di-ammonium phosphate contains 56 kg of filling.

Table 1: Types of chemical fertilisers, nutrient contents and amounts of lime required to neutralise the acidifying effect of the fertiliser.

Chemical fertiliser	Chemical formula	Content in %			CaCO ₃ ⁻ needed*
		N	P	K	
Ammonium sulphate AS	(NH ₄) ₂ SO ₄	21	-	-	110
Calcium ammonium nitrate CAN	(NH ₄ NO ₃)*CaCO ₃	20	-	-	-
Urea	CO(NH ₂) ₂	45	-	-	80
Mono-ammonium phosphate MAP	NH ₄ H ₂ PO ₄	11	20	-	-
Di-ammonium phosphate DAP	(NH ₄) ₂ PO ₄	21	23	-	-
Super phosphate SSP	Ca(H ₂ PO ₄) ₂	-	8	-	-
Triple super phosphate TSP	Ca(H ₂ PO ₄) ₂	-	22	-	-
Basic slag	(CaO) ₅ *P ₂ O ₅ *SiO	-	3-8	-	-
Natural rock phosphate		-	11-17	-	
Potassium chloride	KCl	-	-	50	
Potassium nitrate	KNO ₃ ⁻	14	-	37	-
Potassium sulphate	K ₂ SO ₄	-	-	42	
Potassium magnesium sulphate	K ₂ SO ₄ *MgSO ₄	-	-	18	

*Amount of CaCO₃⁻ needed to neutralise the chemical fertiliser.

In addition to the types listed in Table 1, mixed fertilisers are also often used. These contain various different types of chemical fertilisers. The mixed fertiliser has a specific ratio of the nutrients nitrogen (N), phosphate (P) and potassium (K). They are thus called N: P: K fertilisers. Bags of these fertilisers are always labelled with the amounts of each nutrient contained in them. An N:P:K fertiliser labelled 10:10:10

contains 10 kg N, 10 kg P₂O₅ and 10 kg K₂O per 100 kg. Each 100 kg of fertiliser thus includes 70 kg of filling nutrients that contains no N:P:K. A bag of fertiliser labelled 18:18:0 contains 18 kg N, 18 kg P₂O₅ and 0 kg K₂O per 100 kg fertiliser. In this case 100 kg of fertiliser contains 64 kg of filling. This filling can also contain a different nutrient, such as SO₄²⁻.

11.3 Timing and method of application per nutrient

Each of the various types of chemical fertilisers has its own characteristics, which must be considered in deciding when and how to apply a particular fertiliser. Some fertilisers are adsorbed by the soil particles. This means that the soil particles keep the fertiliser in place for use by plants while at the same time they are able to release it when needed by the plants. If fertiliser is fixed by the soil particles these hold it so tightly that the fertiliser will remain out of reach for most plants permanently. Some fertilisers volatilise i.e. they ‘evaporate’ and disappear in the air without doing anything good for the plants. In addition, it is important to consider when the plant most needs the nutrients that the fertiliser supplies.

Nitrogen

Most annual plants need little nitrogen in the early growing period. They need the most nitrogen in periods of tillering and fast growth. Ammonium (NH₄⁺) is adsorbed and fixed by the soil particles. It is therefore best to thoroughly mix ammonium fertilisers with the soil. Urea must also be well mixed with the soil, rather than be applied on top of the ground where it can be lost through volatilisation. Ammonium and urea may not come within 5 cm of the seeds. Urea is converted to ammonium in the soil and is then adsorbed.

However, the ammonium in the soil is quickly converted into nitrate (NO₃⁻). Nitrate is not adsorbed. This means that nitrogen in the form of nitrate can be easily leached in wet conditions. Nitrate-N can also volatilise in wet conditions via denitrification. In these ways Nitrogen

is lost throughout the growing season. It is therefore better to split the nitrogen fertiliser, rather than use it all at once. In addition to an application at the beginning of the growing season, an application can thus be given at the tillering and/or flower initiation stages.

If ammonium and urea are broadcasted, it is best to apply them before sowing to prevent them from coming close to and scorching the seeds.

Phosphate

Phosphate plays an important role in the root development of young plants. It must therefore be accessible to the young roots at the beginning of the growing season. The super phosphates and the ammonium phosphates are water-soluble, which means that the phosphate is directly available to the plants. For this reason it must be applied right before or during sowing. However, if the phosphate becomes fixed to the soil particles, it is no longer readily available to the plants. Precautions must therefore be taken to minimise contact between super phosphate and the soil. It is best to mix the super phosphate with organic material before applying it. In any case, the phosphate should not be broadcasted, but preferably be applied in rows next to the rows of seeds. Phosphate does not infiltrate; the roots must grow to the phosphate. This is why the phosphate must not be applied very far from the seeds. The phosphates from slag and rock are not water-soluble and they become available to the plants very slowly. Such fertilisers must therefore be applied many weeks before sowing. These phosphate fertilisers are suitable for acidic soils, because the acid helps dissolve them. It is best to broadcast them. Slag and rock-P have the advantage that they also make the soil less acidic. The effect of these slow-releasing phosphate fertilisers is usually not observable until two or three seasons after they are applied.

Potassium

Potassium is also important for the development of the root system and during the growth period. It must be available during the whole growing season. Since potassium is adsorbed by the soil particles there is no danger that it will be lost in run-off, as with nitrogen. Ad-

sorbed potassium is still available to the plants. The required amount of potassium can thus be given in one application at the beginning of the season. Potassium fertilisers must be applied at least 4 cm from the seed. Potassium chloride is not suitable for clay soils or other soils that have poor drainage.

11.4 Liming

Definition: Liming is the process of adding lime, steel slag, or other materials to the soil to make the soil less acidic or to increase its pH level and to improve conditions for the growth of plants and micro-organisms.

A serious problem faced by many farmers in the tropics is the extreme acidity of their soil. A pH level lower than 5 means the soil is so acidic that it inhibits healthy plant growth. Aluminium toxicity is especially problematic. The soil can be made less acidic by adding lime. Factors that contribute to acidic soils are: the use of chemical fertilisers, the removal of crop residues that contain basic elements such as calcium, magnesium, potassium, and sodium, washing away of basic elements from the soil, and the decomposition of fresh organic material into nutrients. Specialised knowledge beyond the scope of this Agrodok is needed to determine how much lime is required to restore balance in a soil that is too acidic. So the discussion here is limited to how much lime is needed to neutralise the acidifying effect of a chemical fertiliser.

Urea and chemical fertilisers that add nitrogen in the form of ammonium (NH_4^+) have an acidifying effect on the soil. This means that the soil becomes more acidic when urea and ammonium fertilisers are regularly applied. Adding lime (calcium carbonate, CaCO_3) can compensate for this effect. The last column of Table 2 shows how many kilos of lime are needed to neutralise the effect of 100 kg of chemical fertiliser.

In adding lime, it is important to apply it not only to the topsoil but also to the lower layers. The lime must reach as deep as the roots of the crops (approximately 30 cms). The lime can leach to deeper layers by itself only in very sandy soils. In all other conditions, the lime must be worked into the soil. The lime may not be applied in large amounts all at once, because roots need time to adjust to major changes in acidity. Moreover, the organic matter in the soil would then decompose very rapidly, which would allow more freed nitrogen to be leached. If the pH is increased too much, phosphate is not released from slow-working fertilisers.

Lime and (hydr)oxides from the chemical fertiliser industry are the most commonly used sources of lime. Two natural sources of lime are coral and marl. Slag from the steel industry and ash is also sometimes used.

These various materials are not equally effective. Their effectiveness is often measured in relation to the effectiveness of calcium carbonate (CaCO_3). For example, the neutralising effect of unslaked lime (calcium oxide, CaO) is 179%. That means that 100 kg of unslaked lime works as well as 179 kg of calcium carbonate. Another important factor is how fine the material is. If the material is very fine, it will dissolve quickly and work faster than a rough material that dissolves slowly. The increase in pH after adding lime is temporary. Lime must be reapplied regularly. This is labour-intensive and usually also prohibitively expensive.

It is thus important to use acid-tolerant crops or varieties, which can produce reasonable yields in low pH soils. In most cases, this means that they can withstand high concentrations of aluminium.

Table 2: Acid-tolerant crops (Source: Sanchez, 1976).

Crops	Scientific names
Upland rice, cassava	<i>Manihot esculenta</i>
Plantain	<i>Musa paradisiaca</i>
Cowpea	<i>Vigna unguilata</i>
Peanut, groundnut	<i>Arachis hypogea</i>
Fruit and tree crops	
Mango tree	<i>Mangifera indica</i>
Cashewnut tree	<i>Anacardium occidentale</i>
Lime, lemon tree, and the other citrus species	<i>Citrus aurantifolia</i> , limon and yhe other citrus species
Pineapple	<i>Ananas comosus</i>
Forage species (leguminous)	
Brazilian lucerne	<i>Stylosanthes guyanenses</i>
Greenleaf, silverleaf desmodium	<i>Desmodium intortum, incinatum</i>
Centro, hairy centrosema	<i>Centrosema pubescens</i>
Kudzu bean or vine	<i>Pueraria lobata</i>
Forage species (grasses)	
Molasses gras	<i>Melinis minutiflora</i>
Signal grass, Suriname grass	<i>Brachiaria decumbens</i>
Brown seed paspalum	<i>Paspalum plicatulum</i>
Jaragua grass, yaraqua grass	<i>Hypharrhenia rufa</i>

Part III: Theoretical background

12 Plant nutrients

The elements that plants need to survive are called nutrients. Nutrients are usually adsorbed from the soil solution in the form of ions. Ions are dissolved salts (nutritive salts) that have an electrical charge. Positively charged particles are called cations (e.g. ammonium NH_4^+), and negatively charged particles are called anions (e.g. nitrate, NO_3^- , phosphate, H_2PO_4^-). These ions will be mentioned again later.

The nutrients that a plant requires to progress through an entire growth cycle are called the essential nutrients. A deficiency of any one of these will have consequences for the plant, such as limited growth, or a lack of flowers, seeds, or bulbs. In addition to the essential nutrients, plants absorb other nutrients that they do not need (e.g. sodium Na) or that can even be harmful (e.g. aluminium Al or manganese Mn). Plants do not need equal amounts of each nutrient. For this reason, the essential nutrients are divided into two groups.

The **macro-nutrients**, which plants need large amounts of:

carbon (C)

hydrogen (H)

oxygen (O)

nitrogen (N)

phosphorus (P)

potassium (K)

calcium (Ca)

sulphur (S)

magnesium (Mg)

The **micro-nutrients**, which plants need only small amounts of:

iron (Fe)

manganese (Mn)

boron (B)
zinc (Zn)
copper (Cu)
molybdenum (Mo)

The functions of the macro-nutrients will be discussed briefly below. The micro-nutrients are just as important for the plant, but they are needed in such small amounts that a deficiency of one or more of them occurs only in special circumstances.

12.1 The macro-nutrients

Nitrogen

Nitrogen is an important building block of proteins in the plant. It promotes the growth of stalks and leaves. With sufficient nitrogen, the leaves become big and succulent; with insufficient nitrogen the plant's growth is severely inhibited, and its leaves are small and fibrous. Nitrogen is also needed for the green colour of the plant. If a deficiency of nitrogen occurs, the older leaves turn pale-green to yellow, and the young leaves eventually do the same. A severe nitrogen deficiency will prevent the plant from flowering. If plants absorb too much nitrogen, the stems and leaves will grow bigger but also weaker. Grains can then wilt more readily, and fungi and aphids have a better chance of damaging the plants. Also, the plants may flower later, which can lead to a lower yield in a short growing season.

In the soil, nitrogen becomes available to the plants mostly as nitrate (NO_3^-) and ammonium (NH_4^+).

Phosphorus

Phosphorus plays an important role in breathing and in the energy supply. It promotes the development of roots in young plants. It has a positive effect on the number of grains per spike and the grain weight and for bulb crops on the bulb and root production. A phosphorus deficiency causes limited growth, especially in the roots, which gives the plants a stucky appearance. The leaves turn a dark, blue-green colour. Some plants turn purplish, first on the stem base, and later on the un-

derside of the main nerve of the leaves. Seed and fruit development is poor or absent. Too much phosphorus is not directly harmful for the plant, except that it can cause a shortage of zinc, copper and iron. Plants can adsorb phosphorus in the form of phosphate ions (H_2PO_4^- or HPO_4^{2-}).

Potassium

Potassium is needed for the firmness of the plant. Potassium makes the crop strong, and ensures that the root system is large and widely branched. It promotes the development of roots and bulbs, and it has a positive effect on the size of fruits and the weight of grains. Plants that have a potassium deficiency stay small and weak, and their leaves fall off. The leaves get pale-coloured spots, beginning on the edges. Later the whole leaf turns brown. A severe potassium deficiency makes the young leaves bumpy, because the nerves are too short. Grains fall over easier. Plants that have little potassium are less able to withstand drought, and will therefore wilt faster. Excess potassium makes the leaves and harvest products watery. An excess of potassium also causes a shortage of magnesium and boron.

Sulphur

Sulphur is needed as a building block of some organic compounds and vitamins and other compounds in the plant. A sulphur deficiency makes the leaves light green or yellowish (as does a nitrogen deficiency!). The plant's growth is inhibited, and the stems are stiff, woody and thin. An excess of sulphur occurs seldom. Plants adsorb Sulphur in the form of sulphate (SO_4^{2-}).

Calcium

As an important component of cell walls, calcium influences the growth and strength of the plant. A deficiency of calcium appears first in the young leaves. They are often deformed, small and strikingly dark-green. Growth points die off. The leaves are wrinkled. Root growth is visibly inhibited, and rotting of the roots can occur. The stem is weak.

Magnesium

Magnesium is needed, among other things, for photosynthesis. With a deficiency of magnesium, coloured spots appear on the leaves, beginning with the older leaves. The nerves of the leaves sometimes stay green. In grains, yellow stripes appear lengthways on the leaves. A magnesium deficiency can retard the ripening of grain. An excess of magnesium occurs seldom.

Every nutrient thus has its own function in the plant. A shortage of one nutrient cannot be compensated by a higher dose of another. The element that is most lacking determines the height and yield of the plant. This is schematically demonstrated in Figure 10.

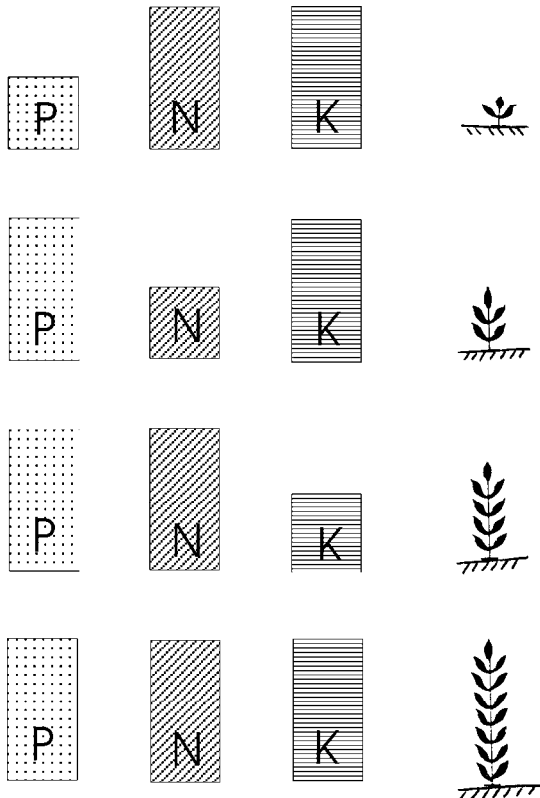

Figure 10: The growth of the plant is determined by the element that is most lacking (Source: FAO, 1984).

13 Important soil characteristics

13.1 Soil structure

About half of the soil consists of solid soil particles and organic matter. The solid soil particles form the framework of the soil. The other half of the soil consists of pores. The pores are partly filled with air and partly with water. The proportions of these elements are schematically presented in Figure 11. Small pores are good at holding water. Large pores lose water quicker and are therefore usually filled with air. Many micro-organisms also live in the soil.

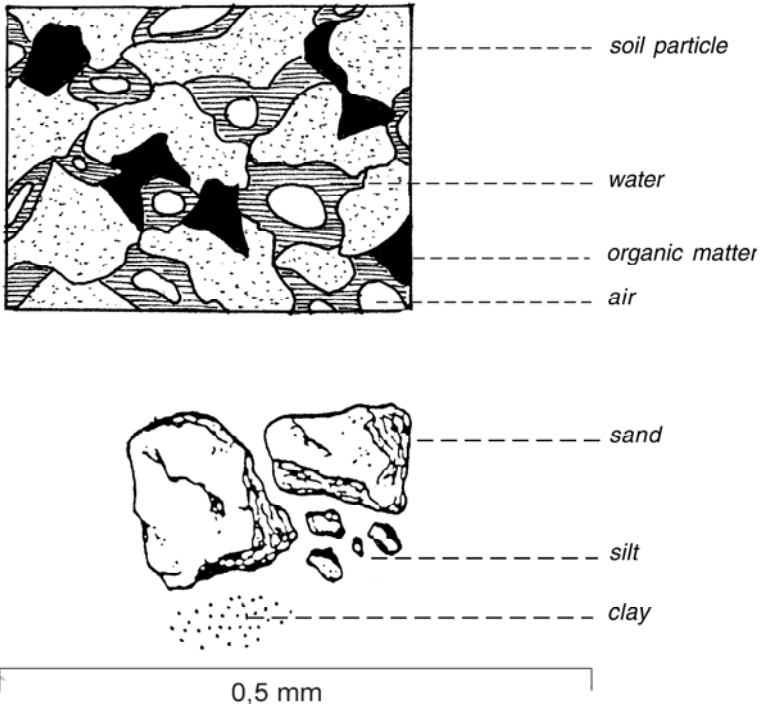

Figure 11: The proportions of solid particles, organic matter, water and air in the soil (Hillel, 1980 and Barbera Oranje).

13.2 The solid soil particles

The solid soil particles are divided into four texture groups according to their size:

- gravel and stones: particles larger than 2 mm;
- sand: particles smaller than 2 mm but larger than 0.050 mm;
- silt: particles smaller than 0.050 mm but larger than 0.002 mm;
- clay: particles smaller than 0.002 mm.

The difference between sand, silt and clay is of course not visible to the naked eye. But it is important to distinguish between them, because each of the textural groups has its own characteristics.

Clay particles are the smallest soil particles. They have the ability to adsorb nutrients and to 'hold' them. The pores between the clay particles are very small. Clay expands when it gets wet. Clay sticks together very well. Dry clay is solid and very hard.

Both the size and characteristics of silt particles fall between those of clay and sand particles. The pores are smaller than in sand, but larger than in clay. Silt particles can adsorb few nutrients. Silt particles are not very sticky; they rather feel like talcum powder when dry, or soap when wet.

Sand particles are big enough to distinguish with the naked eye. They feel very gritty. Sand particles adsorb nutrients very poorly. Because they are rougher than clay and silt particles, the pores between the sand particles are larger. Sand particles do not stick together.

Gravel and stone are not useful for plants. They do not retain any nutrients or water, and where a stone is present it takes the place of clay or silt which can retain water or nutrients. The plant roots also have to waste energy on growing around the stones.

13.3 Aggregates

If a soil consists of various texture groups, the soil particles tend to form aggregates. Aggregates are clumps or clusters of various soil particles (sand, silt, clay and organic matter). Humus often works as a kind of ‘cement’ in the formation of aggregates. Organic matter therefore aids the formation of aggregates. In addition, soil organisms play an important role in the formation and stability of aggregates. Moulds and Actinomycetes can bind the soil particles together with their mould threads. Earthworms ‘eat’ soil, and in their stomachs they form aggregates of soil particles and humus, which they later excrete.

Through the formation of aggregates, pores are created of various sizes: fine pores, which hold water within the aggregate, and large pores between the aggregates. Water sinks quickly out of the large pores, which allows them to stay filled with air. Soil aggregates thus provide the roots with essential water, nutrients and oxygen.

13.4 Organic matter in the soil

The organic matter in the soil consists of fresh organic material and humus. Fresh organic material is plant and animal waste that has not yet decomposed, such as roots, crop residues, animal excrement and cadavers. The fresh material is transformed by soil organisms into humus, which is also called soil organic matter. In the process, nutrients are released (Figure 12); organic matter thus makes nutrients available to the plants. Humus, i.e. soil organic matter, is material that has been broken down so far that the original fresh material is no longer distinguishable. It gives the soil a dark colour. Humus itself is also broken down by the soil organisms, which releases even more nutrients, but this process takes much longer. Humus can also retain a lot of water and nutrients.

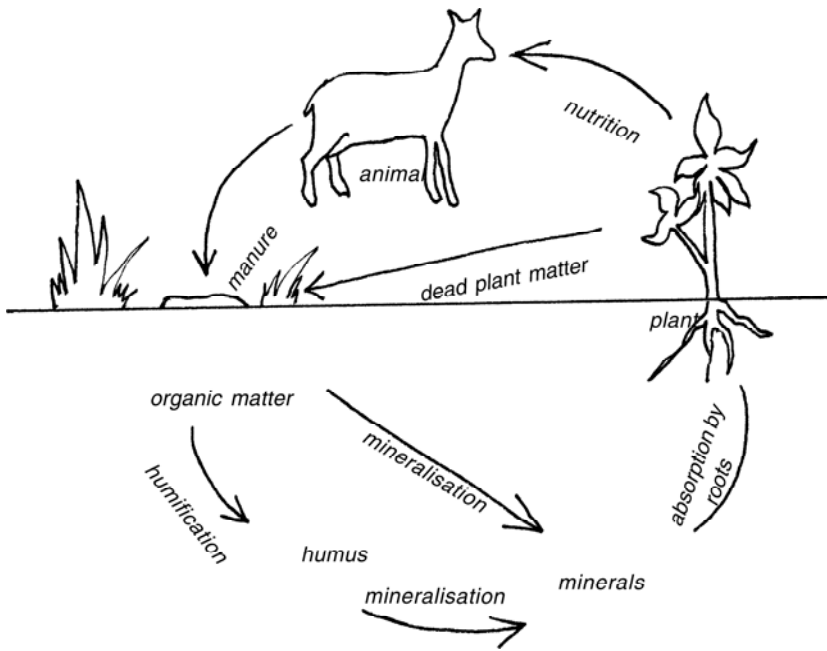

Figure 12: The cycle of organic matter (Barbera Oranje).

Organic matter has a great capacity to retain nutrients and thus increases the CEC in the soil (see also the chemical characteristics of the soil below). This is especially important in sandy soils, which retain very few nutrients.

Organic matter can retain a lot of water, which means that in dry periods more water is available for the plants for a longer time. This is also especially important in sandy soils, which retain little water.

Organic matter aids aggregate formation and can thus improve the soil structure. This is important for both sandy and clay soils, because they have a poor structure.

Organic matter can bind H^+ and thus prevent soils from becoming acidic.

Finally, organic matter stimulates the growth of soil organisms, which helps make the nutrients in the organic matter available to the plants.

13.5 Soil organisms

Many types of soil organisms live in the soil, both animal and vegetal. Some are clearly visible, such as earthworms, beetles, mites, nematodes (eelworms) and termites. However, most of them are so small that they cannot be seen with the naked eye or a magnifying glass. These organisms are called the micro-organisms; the most important of which are bacteria, moulds, and Protozoa. Millions of micro-organisms live in just a handful of fertile soil. Figure 13 shows what a few of the most important soil organisms look like.

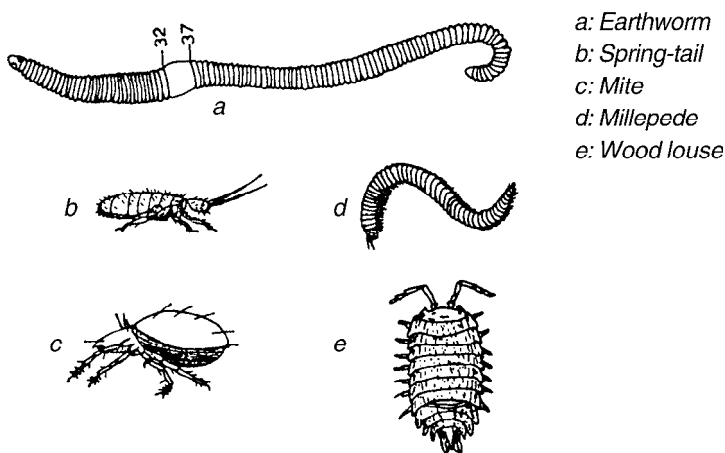

Figure 13: Some of the most common soil organisms (Source: Uriyo, 1979).

Insects and micro-organisms that live in the soil are good for the soil structure:

- Soil insects like earthworms and beetles dig tunnels that can later function as pores. Plant roots can also use these tunnels, which is especially beneficial in soils that have mostly small pores (many clay soils).

- They also aid in the formation and stability of aggregates.
- They ensure that the soil and organic matter are well mixed. By eating the fresh organic matter and excreting it somewhere else, the soil organisms spread the organic matter throughout the soil. Without the soil organisms, the organic matter would stay on top of the soil.

A good mixture of soil with organic matter is important for the following reasons:

- Nutrients are released from the organic matter. These have to become available where the roots are, thus throughout the whole top layer of soil.
- Organic matter can improve the soil structure by forming aggregates with the solid soil particles. But to do this, the organic matter must first be mixed with the soil particles.

13.6 Immobilization of nitrogen (N) and the C:N ratio

Micro-organisms decompose organic matter, which releases nutrients. However, the micro-organisms themselves also need carbon and nutrients, including nitrogen. The tissue of all organic material is made up nearly half of carbon. The level of nitrogen varies widely between different types of organic material. In general, organic material that is old and tough has a high C:N ratio, in other words, the nitrogen content is low compared to the amount of carbon. Young and succulent material generally has a low C:N ratio, that is, it has a high nitrogen content. If organic material is added that is old and tough (straw for example), then the micro-organisms initially need more N than is released from the material. They will then absorb not only all of the nitrogen that is released from the straw, but also all of the nitrogen that was already available in the soil (for example as nitrate-nitrogen (NO_3^-) or ammonium-nitrogen (NH_4^+)). After straw is worked into the soil, there is thus a period of time in which all of the available nitrogen in the soil is taken by the micro-organisms. This is called immobilisation. Little or no nitrogen is then available for the plants. Once the straw is com-

pletely decomposed, there is no longer enough food available for all of the micro-organisms.

A large proportion of the micro-organisms then dies and is themselves decomposed. The nitrogen that the micro-organisms had adsorbed becomes once again available for the plants. In warm, moist conditions this cycle occurs quickly, and the period of immobilisation is short (weeks). In dry areas the period of immobilisation is long (more than a growing season).

13.7 Chemical characteristics of the soil

In addition to the structure of the soil, two other characteristics help determine the availability of nitrogen in the soil: the acidity (pH) and the cation exchange capacity (CEC).

Soil acidity (pH)

The acidity level refers to the extent to which the moisture in the soil is acidic or alkaline (= not acidic). An extremely acidic soil can be compared to vinegar, an extremely alkaline soil to soap. Clearly, soil acidity thus influences the growth of plant roots. The acidity level is indicated with the symbol pH. Acidic soil has a pH lower than 6. A soil is acidic if a lot of H^+ is present. An alkaline soil (i.e. a soil that is not acidic) has a pH higher than 7. Soil that has a pH between 6 and 7 is neutral: between acidic and alkaline. A pH of 4 or 10 is extreme, most soils have a pH between 5 and 9. Both high and low pH levels can result in nutrient deficiencies. A low pH also results in an excess of iron (Fe, at pH levels < 4.5), aluminium (Al, at pH levels < 5), and manganese (Mn, at pH levels < 4.5) in the soil. Excessive amounts of these nutrients are very poisonous for plants.

Soil acidity also has an important influence on the availability of nutrients for the plant, such as can be seen in Figure 14. Micro-organisms are also less active in soils that have a high or low pH: they decompose less organic matter, which results in fewer available nutrients.

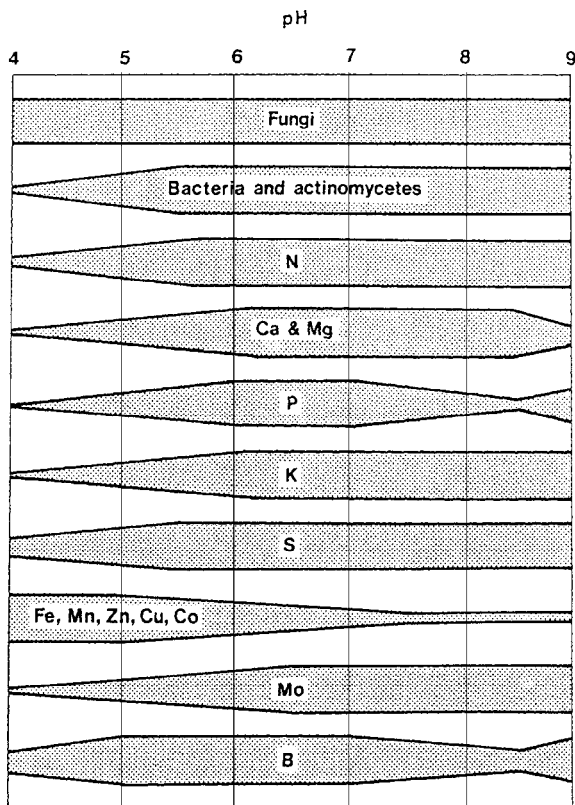

Figure 14: Availability of important nutrients and activity of micro-organisms at various pH levels (a wider band represents higher availability or more activity) (Source: FAO, 1984).

Plants differ in their sensitivity to a low or high pH and to aluminium, iron and manganese toxicity. Some plants can withstand or even prefer a somewhat low pH level, others a higher one. These characteristics for some plants are given in Figure 15.

The CEC: Cation Exchange Capacity

Most soil particles have a negative charge. They therefore attract nutrients present in the soil in the form of positively charged cations. The

cations are lightly bound: a constant exchange of cations takes place between the soil particles and the soil solution. The ability of the soil to bind positively charged nutrients is called the Cation Exchange Capacity. The CEC is determined by the proportion of various texture groups and humus: clay particles bind a lot of nutrients, and give thus a high CEC, sand and silt bind few cations and contribute thus little to the CEC. Humus can bind a lot of nutrients. Even though it constitutes only a small part of the soil, it can make a large contribution to the CEC.

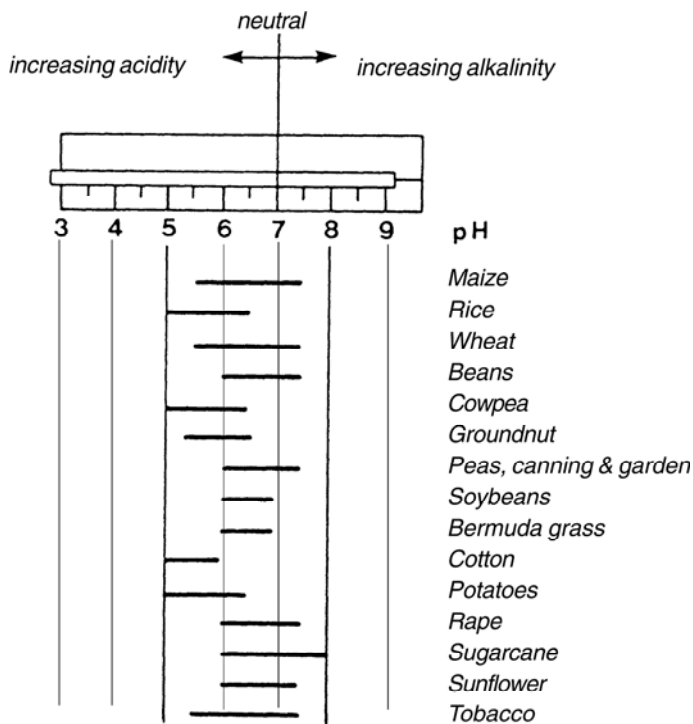

Figure 15: Optimal soil pH for some plants (Source: FAO, 1984).

14 Soil assessment

To assess the suitability of soils for agriculture, a number of important factors must be considered:

- texture and structure of the soil;
- presence of impermeable layers;
- level of organic matter and soil life;
- nutrient supply;
- pH level.

General indications for some factors can be gained through simple observation and experiments. For others, professional assistance is needed via an agriculture information centre or soil science institute. Below are some suggestions for steps that you can take yourself.

14.1 Soil texture and structure

Solid soil particles determine to a large extent the characteristics of a particular soil. Soils are therefore divided into various texture classes based on the ratio of different texture groups present. In addition to the texture class, it is also important to know how the soil particles are arranged. This is called the soil structure. If many pores of various sizes are present, the soil has a good structure. If only small or large pores are present, the soil structure is poor. Aggregates thus create a good soil structure. Aggregate stability is also important: if the soil has weak aggregates it will be more likely to form a crust (see Part III, Chapter 13).

Identifying the texture class

By carrying out a number of simple tests, you can determine the texture class of a soil.

- A ball of about 2.5 cms diameter is formed from approximately 1 tablespoon of fine earth.
- Water is slowly dripped onto the soil until it approaches the sticky point, i.e. the point at which the soil just starts to stick to the hand.

- Describe how the soil feels: is it gritty, smooth or sticky?
- Try to make a firm square of soil.
- Try to roll up the square. If that works, moisten the roll and then look at its surface; is it shiny or dull?
- Try to bend the roll into a ring.
- Based on the appearance of the ring, determine whether the soil is sticky, brittle or completely loose, when it is both wet and dry.

You can then use Table 3 to identify which texture class corresponds to your soil.

Table 3: Texture classes.

Soil texture classes	Feel of soil	Can form a firm square	Can form a thin roll	Can form a ring	Moist	Dry
Sand	very gritty, does not make fingers dirty	no	no	no	loose and single grained	loose
Loamy sand	very gritty	no, forms weak square	no	no	somewhat cohesive	loose
Silt loam	smooth, fine powder	yes	yes, n poor shape and dull surface	no	feels soapy	soft, dusty
Loam	gritty and sticky	yes	yes	no	feels soapy and is more-or-less plastic	soft, dusty
Clay loam	smooth and sticky	yes	yes, good shape, shiny surface	no	firm	somewhat hard to hard, no dust
Light clay	no gritty parts any-more only sticky	yes (firm)	yes, good shape, shiny surface	yes (showing cracks at outside)	very firm	hard to very hard, no dust
Heavy clay	very sticky	yes (very firm)	yes, good shape, shiny surface	yes, with-out cracks	very firm	hard to very hard, no dust

Sandy soils are open, loose and brittle. They have good ventilation and drainage. They are also easy to work with when they are wet or dry. One disadvantage is that sandy soils are not good at retaining water and nutrients for plants. The texture classes sand or loamy sand represent sandy soils.

Soil that has equal amounts of clay, silt and sand is called loam soil. This ideal soil is good at retaining water and nutrients, has good drainage and ventilation and is easy to work with. If the loam soil has more clay or sand in it, it takes on more of the characteristics of a clay or sandy soil. The texture classes that fall under loam soils are sandy loam, silt loam, clay loam, and loam.

Both black and greyish-brown clay soils have small pores, which means that they have poor drainage and ventilation. Plant roots have difficulty growing through the small pores. The red clay soils have a special structure: the clay particles are arranged in such a way that some large pores are present. The red clay soils therefore have good drainage and ventilation. They are easily transformed into a muddy substance though, just as with other clay soils, if they get wet and are under pressure (due to ploughing for example). Clay soils have a great capacity to retain water and nutrients. However, these are difficult to cultivate. When dry clay soils are very hard and when wet clay soils are very sticky. Clay soils include the texture classes sandy clay, silty clay and clay.

Assessing the stability of aggregates

The following test gives an indication of the stability of aggregates in the soil. Take a pot or a jar. Sieve the aggregates out of the soil (with a sieve or if necessary with your hands) and place them in the container. Draw a line just above the aggregates. Now pour water into the container along the edge until the soil is saturated or until the aggregates are just covered. Do not pour the water directly on the aggregates! Let this stand for a few minutes. Then tap the container firmly a few times. Let it stand again for a few minutes. If the aggregates still reach

the line then their stability is generally good. If the aggregates are now much lower than the line, their stability is poor.

Of course you can also get an indication of aggregate stability in the field by observing the soil after a heavy rain. If the surface is sealed, then the aggregate stability is low.

14.2 Level of organic matter

You can see whether a soil contains a lot or little organic matter by its colour. Organic matter is mostly present in the top layer of soil. This layer thus takes on a darker colour, because humus is black. If the top layer is not noticeably darker than the underlying layers, this means that the soil contains little organic matter.

Another indication of the presence of organic matter is the presence of soil organisms. If you see many organisms in the soil, then organic matter must also be present. Some of the soil organisms that you can see are earthworms, small beetles, and springtails. Another test is to heat a large handful of soil in a pan of water. If it starts to smell like mould, then the soil probably contains organic matter.

14.3 Impermeable layers

To assess a soil it is important to look not just at the top layer, but also at the underlying layers. Most of the organic matter and nutrients are usually in the top layer. However, the plant roots also get a lot of water and nutrients from the underlying layers. If the roots cannot penetrate through the second layer of soil, they will have to get all of their water and nutrients from the top layer. This means that less water and fewer nutrients are available for them, and the root system will be limited. This can be seen in Figure 16. A deficiency of water and nutrients is thus more likely in soil that has an impermeable layer.

If the impermeable layer is close to the surface (less than half a metre deep), the soil will probably not be able to sustain crops. With mechanised agriculture it is possible to break through an impermeable clay layer by ploughing very deep. The underlying layer is then mixed with the layer above it. However, it is nearly impossible to do this manually.

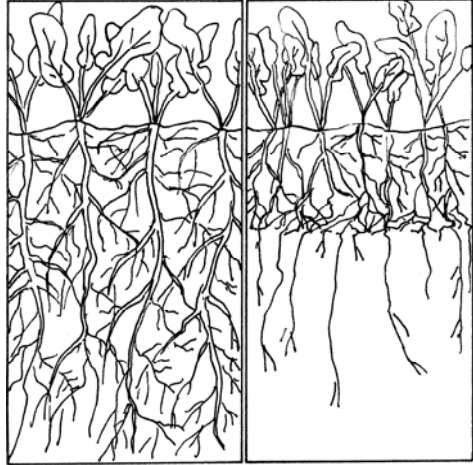

Figure 16: The effects of an impermeable layer on the root system.

Another problem that can occur with impermeable layers, is that rainwater after a heavy rain cannot infiltrate into the subsoil. All the pores above the impermeable layer then become saturated with water and the roots cannot get enough oxygen. Without oxygen the roots cannot breathe or absorb water and nutrients.

14.4 Nutrient supply

Visual observation

This method entails checking the plants in the field for signs of a nutrient deficiency. These are symptoms that specifically indicate a deficiency of one particular nutrient.

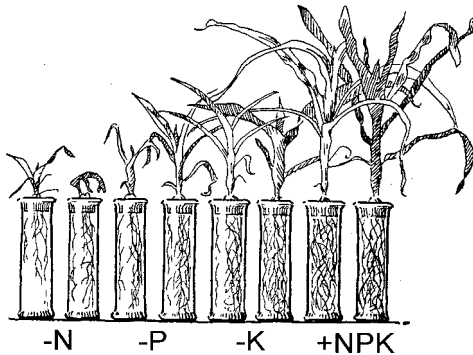

Figure 17: Grains growing in various nutrient solutions that each lack a sufficient level of one particular element. The plant on the far right has no nutrient deficiencies (Source: Bloemsma, 1946).

Figure 17 shows how a shortage of one element in the soil affects grain.

The deficiency symptoms that agricultural plants can develop due to a shortage of one element are listed in Table 4.

Table 4: Deficiency symptoms.

First visible in older leafs	Nutrient
yellowing, beginning at the leaf ends	Nitrogen
Drying out at the leaf edges	Potassium
Yellowing, especially between the nerve ends (which stay green)	Magnesium
Brown, grey or white spots on leaf	Manganese
Reddish-purple colour on green leaves or stems	Phosphorus
Drying out between the leaf nerves and in the smallest leaves	Zinc
First visible in the young leaves	Nutrient
Spotted yellowish-green leaves with yellow leaf nerves	Sulphur
Spotted yellowish-green leaves with green leaf nerves	Iron
Brownish-black spots	Manganese
Yellowing on the leaf edges	Molybdenum
Youngest leaves are white at the ends	Copper
Youngest leaves are brown or dead at the stem	Boron
Youngest leaves are black or dead on the top	Calcium

Determining whether a plant has a nutrient deficiency by means of an analysis of its deficiency symptoms can thus be very complicated. A lot of experience is needed to perform the analysis well. In many cases, however, there is no other option and the visual interpretation method can provide a good indication.

Field-tests

In this method a field study is done to determine which nutrients the plants are lacking. This is done by comparing designated areas that are not fertilised with areas where one additional element has been added (usually N, P or K), and areas where a combination of these elements has been added. If no difference appears between the fertilised areas and the unfertilised areas, then there was no shortage or another limiting factor is present. If the yield of the fertilised areas is higher, then a shortage did exist. By experimenting with various amounts of added

elements, the exact dosage can be determined. This can then be compared to the soil analyses.

Soil types

No two soils are exactly alike, but most soils have characteristics in common. If soils have many characteristics in common, we speak of a soil type. If you know what type a soil is you will know a number of its important characteristics and limitations. There are many ways to classify soil types. Appendix 1 lists a number of common soil types, their characteristics and the problems often associated with them. This list follows the classification system developed by the UN Food and Agriculture Organisation, which divides the soil types according to easily recognisable characteristics.

Soil maps have been made for a great many areas. Information on soil maps is often available from the agriculture information service. Soil maps are also sometimes available from soil research institutes.

Another way to gain information on soils is through local knowledge. Farmers can often describe what they consider to be a good soil, and how they recognise a good or poor soil. Their method could be based on the colour, how a soil feels or on existing vegetation. Plants that grow spontaneously on a particular soil can be a good indicator of the soil's characteristics. Some plants grow only in acidic or lime-rich soil, some grow only in very fertile soil, while still others prefer soils that are often waterlogged (indicator of poor drainage). Since the presence of various plants differs greatly per region, it is impossible to give any general guidelines on this subject.

Appendix 1: A few important soil types in the tropics

Red, reddish-yellow or yellow clay soils (ferralsols)

These are highly weathered, very poor clay soils. They contain few nutrients. They have a brittle structure that easily changes into a muddy substance when wet. Roots, water and air can penetrate them easily. They retain little water and nutrients. Iron and aluminium toxicity can occur. The cultivation of annual plants leads to a loss of organic matter, erosion and severely diminished fertility. The only possible agricultural use is with a system that includes long fallow periods or forest-type plantings. It is important to keep the ground covered and the nutrient cycle closed.

Shiny red and reddish-brown clay soils (nitisols)

These can be differentiated from the ferralsols because their aggregates have a shiny surface that is absent in ferralsols. They have a loose, brittle structure, but they can still retain water well. Roots easily penetrate them. They are not as poor in nutrients as ferralsols, because they are reasonably good at retaining nutrients. These soils can be productive if fertiliser is applied regularly and well balanced. They can be permanently cultivated, but ideally the ground should always be covered.

Sandy soils (arenosols)

These soils consist mostly of sand, which gives them a poor structure. They are easy to work with. They are easily permeated by roots, water and air, but they retain little water. In areas with high rainfall (more than 1000 mm per year) these soils are often acidic. It is important to maintain the level of organic matter. Stall manure can be used to improve the soil. Plants with deep root systems are preferable to plants with shallow root systems. These soils are very sensitive to erosion.

Limy soils (calcisols)

Limy soils contain a very large amount of lime (calcium carbonate). They occur mostly in dry and very dry areas, where water is the most important limiting factor for agriculture, in addition to the possible abundance of stones in the soil. Limy soils have a good structure and a good capacity to retain water. These soils are fertile despite their low content of organic matter. Drought resistant crops can be grown.

Shallow soils (leptosols or lithosols)

Shallow soils (less than 10 cm) on rock or limestone cannot retain enough water and nutrients to support crops. The roots of trees and shrubs are more capable of penetrating the hard layer, so the best solution is to keep these soils covered with forest. If these soils are to be used for agriculture, a multi-year cultivation system (agroforestry) is recommended.

Black soils (vertisols)

These are heavy clay soils, which contain little organic matter. The clay causes the black colour. In the dry season wide deep cracks develop which allow a lot of rainwater to penetrate at the beginning of the rainy season. Once the ground is wet, it expands, the cracks close and the water cannot infiltrate further into the soil.

Black soils can produce high yields under good management.

They are difficult to work with; when wet they are very heavy and sticky, and when dry they are extremely hard. The structure of these soils is very poor and the infiltration capacity for water is very limited. Adding organic matter is an important way to improve the structure. Good drainage is also important. These soils are rich in magnesium and calcium, but they need extra nitrogen and phosphorus.

Salty soils (solonchaks)

Salty soils have no structure and a lot of salt. Often white spots appear on the surface where salt has accumulated. These soils occur in dry areas where the groundwater is not very deep. For agricultural use they must have a good irrigation and drainage system.

Heavily weathered soils with underlying clay layer (acrisols, alisols and luvisols)

These are soils that have a layer of disconnected material without aggregates on the surface, and a clay layer underneath. Drainage is therefore poor. For agricultural use, a drainage system has to be added to transport the water that cannot infiltrate the soil. The surface layer is very easily transformed into a muddy substance and is very sensitive to erosion. Soil fertility is low. It is very important to maintain the level of organic matter because of its positive effect on the soil structure. Due to the low fertility these soils can be very acidic (acrisols and alisols) and they can develop signs of aluminium toxicity. Adding lime can be beneficial.

Fertile alluvial soils (fluvisols)

Young soils develop from silt deposits in river valleys, estuaries and coastal areas. In most cases these soils are regularly covered by floods, which deposit more silt. Therefore they are often very fertile. Intensive use can lead to nutrient depletion. If they are used intensively, it is important to maintain a sufficient level of nutrients and organic matter.

Further reading

Board on Science and Technology for International Development. **Vetiver grass: A thin green line against erosion.** 1993. National Research Council, National Academy Press, Washington, D.C. ISBN 0-309-04269-0.

Budelman A., Defoer T. **Managing soil fertility in the tropics.** KIT , The Netherlands. ISBN: 90-6832-128-5. With CD-rom.

Chleq, J. and Dupriez, H. **Vanishing Land and water, Soil and water conservation in dry lands.** 1988. Terre et Vie/CTA. ISBN 0-333-44597.

Diop J-M, Gaschini G, Jager A de, Onduru D. **Exploiting new innovative soil fertility management in Kenya.** 2001, IIED, Edinburg GB, 20 pp.

Driessen, P.M. and Dudal R., eds. **Lecture notes on the major soils of the world.** 1989. Agricultural University Wageningen, The Netherlands, and Catholic University of Leuven, Belgium.

Dupriez, H. and de Leener, Ph. **Agriculture in African rural communities.** 1988. Terre et Vie/CTA. ISBN 0-333-44595-3.

Dupriez, H., de Leener, Ph. and Tindall, H.D. **Ways of Water, Run-off, Irrigation and Drainage.** 1992. Terre et Vie/CTA. ISBN: 0-333-57078-2.

Gichuru, M.P., Bationo, A., Bekunda, M.A., (eds). **Soil fertility management in Africa: A regional perspective.** 2003, CTA 322 pp, ISBN: 9966-24-063-2

Giller, Ken E. and Wilson, Kate J. **Nitrogen Fixation in Tropical Cropping Systems.** 1991. CAB International. ISBN 0-85198-842-3.

Hilhorst T. and Muchena F. **Nutrients on the move: Soil fertility dynamics in African farming systems.** 2000, Russel press, Nottingham, Uk, 146 pp, ISBN: 18 99825568

Müller-Sämman, K.M. and Kotchi, J. **Sustaining growth: soil fertility management in tropical smallholders.** 1994. [CTA: GTZ] Margraf Verlag, Weikersheim, Germany. ISBN 3-8236-1226-3.

Müller-Sämman, Karl M., Kotschi, Johannes. **Sustaining Growth, Soil fertility management in tropical smallholdings.** 1994. GTZ/CTA. ISBN 3-8236-1226-3.

Scoones Ian-Toulmin Camilla. **Policies for soil fertility management in Africa.** 1999, IDS-Brighton-UK, 128 pp, ISBN: 1899825 41 X

Swift MJ, Woormer PL. **The biological management of tropical soil fertility.** 1994, Wiley, 243 pp, ISBN: 0471 950955

Tulu, T. **Soil and water conservation for sustainable agriculture.** 2002, CTA, 155 pp, ISBN: 14068011059

Useful addresses

FAO, Food and Agriculture Organization of the United Nations
Land and Water development division
Viale delle terme di carcalla, Rome, Italy
E-mail: FAO-HQ@fao.org ;
Web-site: <http://www.fao.org/ag/AGA/AGAP/LPS/dairy/intro.htm>

Alterra-ILRI, International Institute for Land Reclamation and Improvement
Postbus 47; 6700 AA Wageningen, Pays-Bas
Fax: 31 317 47 47 00
E-mail : info@altera.wur.nl ; web-site : www.ilri.nl

HDRA, Henry Doubleday Research Association (HDRA)
Coventry CV8 3LG, UK
Fax: 44 (0) 2476303517
E-mail : enquiry@hdra.org.uk ; web-site: www.hdra.org.uk

KIOF, Kenyan Institute of Organic Farming
P.O.Box 34972, Nairobi, Kenya
Fax: 254 (2) 58 33 83 /5831 94
E-mail : kiof@icconet.co.ke

ICRAF, World Agroforestry centre
P.O.Box 30677 Nairobi, Kenya
Fax: +254 02 524000
E-mail : b.jama@cgiar.org ; web-site : www.cgiar.org/icraf

IITA, International Institute for Tropical Agriculture
P.O.Box 5320, Ibadan, Nigeria
E-mail : IITA@cgiar.org ; web-site : www.iita.org

Glossary

(Many of these terms are explained further in Part III, Chapter 13)

Acidifying	The process in which the Ph of the soil becomes lower, i.e. the soil becomes more acidic. It takes on the properties of vinegar, which are not beneficial to many crops.
Adsorb	To bind cations dissolved in the soil liquid to the soil particles.
Aggregates	Crumbs of soil particles, which are loosely bound together.
Aniones	Negatively charged particles.
C:N ratio	The proportion of C and N present in the soil or organic matter. The smaller this proportion is, the easier it is for soil organisms and plants to absorb the N.
Cations	Positively charged particles.
Crop rotation	Cultivation of different crops on the same field successively. For example: the first year maize is grown, the second year beans and the third year the land is left fallow. In this case the crop rotation is: maize-beans-fallow.
Crust formation	Formation of a thin crust on top of the soil by the impact of rain drops. Rain drops breaking the soil aggregates cause the formation of a thin compacted layer, i.e. crust, on top of the soil.
Decomposition	Breaking down of organic matter by soil organisms. In this process nutrients are freed that will be available to plants.
Denitrification	Nitrate is transformed into a gas that disappears into the air or 'evaporates'. In this way nitrogen is lost to plants and soil.
Drainage	Transport of water away from the soil or field.
Erosion	Loss of soil particles caused by wind or water.

Fixation	Very strong bond of nutrients by soil particles. The bond is so strong that nutrients do not go back into the soil liquid and cannot be absorbed by plants anymore.
Green fertiliser	Any organic matter that is ploughed into the soil in order to supply it with nutrients.
Humus	Organic matter that has been broken down in such a way that the original material cannot be recognised anymore.
Immobilisation	The process in which nutrients have been absorbed by soil organisms. These will become available to the crops after the organisms die.
Infiltration	The process in which water penetrates into the soil. This is a very important process because water can only be used by plants after it has infiltrated into the soil. If infiltration is poor, the risk of erosion is very high.
Leaching	The loss of water, nutrients and soil particles from the top soil to the subsoil. This is often caused by an excess of drainage.
Level of organic matter in the soil	The amount of organic matter in the soil as compared to other elements that form part of the soil.
Micro-organisms	Creatures that are so small that they cannot be seen by the naked eye. Only a microscope can make them visible.
Mineralisation	The same process as decomposition, which is explained above.
Mulch	A layer of organic or inorganic matter on top of the soil. It is used to protect the soil against heat from the sun and erosion.
Nitrogen fixation	Some plants are able to bind nitrogen from the air. This is called nitrogen fixation. The plants which are able to do this are called nitrogen fixing plants.
Nutrient balance	The equilibrium between elements needed by plants and animals. This equilibrium must be balanced in

	two ways. First, no element should be lacking or in excess. Second, the amount of nutrients taken away as produce must be kept as close as possible to the amount applied to the crop in the form of manure or fertilisers.
Nutrient pump	Plants with deep roots bring nutrients back to the topsoil where they can be used again by shallow rooting crops, such as most arable crops.
Nutrients	The elements or chemical compounds plants and animals need to survive and produce.
Organic matter	Leftovers of dead animals and plants are transformed into organic matter.
Photosynthesis	The process in which plants elaborate plant tissues out of water, air and sun light.
Pores	The space in between the soil particles. They are important because water and nutrients are stored in them and because they allow air and plant roots to penetrate the soil.
Recovery	The percentage of chemical fertiliser applied that is absorbed by the crop.
Respiration	The process in which plants break down organic compounds. Through this process plants generate the energy necessary to grow and propagate themselves.
Root zone	The part of the soil in which the roots are present. Generally this is the top soil.
Soil organisms	Small beings that live in the soil often worms but also insects and other creatures.
Soil particles	Sand, silt clay.
Soil structure	The way in which the soil particles are arranged.
Soil texture	Soils can be classified according to the size of the particles. If many bigger sized particles are present the soil is classified among the sandy soils. If the majority of the soil particles are smaller sized the soil belongs to the clayey soil types.