

GLOBAL Trac Pro

L1/L2/L3/neutral/ground 16 A/400 V. IP20.

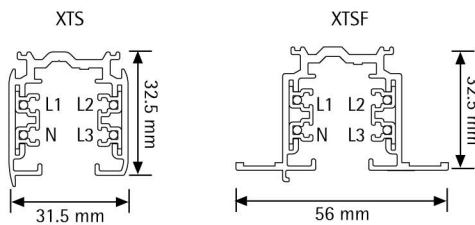

The recommended fastening distance is 1000 mm.
 NOTE: A load not heavier than 10 kg may hang on a power takeoff adapter, the pull strength being 100 N (1kp = 9.81N) and the maximum torque 2.5 Nm. (GA 69 5 kg/50 N).

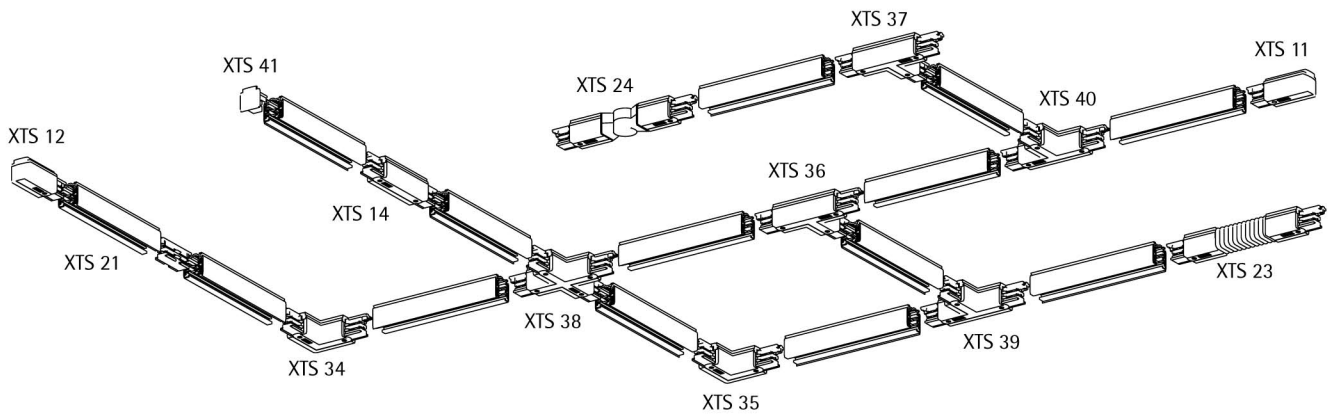
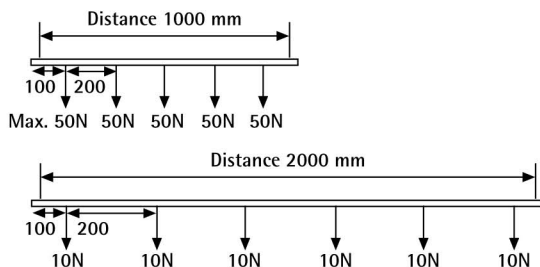

L/mm	a/mm	b/mm	c/mm	d/mm
1000	250			
2000	250	1000		
3000	250		1000	1000
4000	250		1500	1000

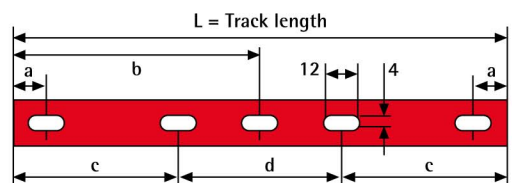

GLOBAL Trac Pro tracks

Available colours: -1 natural anodised aluminium (EN 000), -2 black (RAL 9005), -3 white (RAL 9010).

XTS 4100-4400

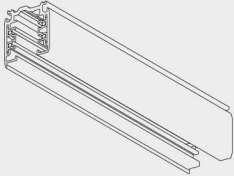

Type	EAN code	Dimensions in mm/ track length	Surface treatment/colour/ material	PCS/ Package
XTS 4100-1	64100 14 507 01 -5	1000	Aluminium	4/240
XTS 4100-2	64100 14 506 01 -8	1000	Black	4/240
XTS 4100-3	64100 14 507 06 -0	1000	White	4/240
XTS 4200-1	64100 14 507 02 -2	2000	Aluminium	4/240
XTS 4200-2	64100 14 506 02 -5	2000	Black	4/240
XTS 4200-3	64100 14 507 07 -7	2000	White	4/240
XTS 4300-1	64100 14 507 03 -9	3000	Aluminium	4/240
XTS 4300-2	64100 14 506 03 -2	3000	Black	4/240
XTS 4300-3	64100 14 507 08 -4	3000	White	4/240
XTS 4400-1	64100 14 507 04 -6	4000	Aluminium	4/240
XTS 4400-2	64100 14 506 04 -9	4000	Black	4/240
XTS 4400-3	64100 14 507 09 -1	4000	White	4/240
XTSF 4100-1	64100 14 507 51 -0	1000	Aluminium	6/180
XTSF 4100-2	64100 14 506 51 -3	1000	Black	6/180
XTSF 4100-3	64100 14 507 56 -5	1000	White	6/180
XTSF 4200-1	64100 14 507 52 -7	2000	Aluminium	6/180
XTSF 4200-2	64100 14 506 52 -0	2000	Black	6/180
XTSF 4200-3	64100 14 507 57 -2	2000	White	6/180
XTSF 4300-1	64100 14 507 53 -4	3000	Aluminium	6/180
XTSF 4300-2	64100 14 506 53 -7	3000	Black	6/180
XTSF 4300-3	64100 14 507 58 -9	3000	White	6/180
XTSF 4400-1	64100 14 507 54 -1	4000	Aluminium	6/180
XTSF 4400-2	64100 14 506 54 -4	4000	Black	6/180
XTSF 4400-3	64100 14 507 59 -6	4000	White	6/180

XTSF 4100-4400

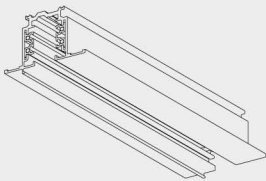

GLOBAL Trac Pro accessories

Power supply option in all connectors except XTS 21, XTS 23 and XTS 24. All materials used are halogen free and VO-self-extinguishing. Available colours: -1 grey (RAL 7040), -2 black (RAL 9005), -3 white (RAL 9010).

End feed XTS 11

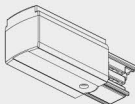

XTS 12

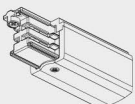

Type	EAN code	Polarity ridge	Surface treatment/colour/ material	PCS/ Package
XTS 11-1	64100 14 507 15 -2		Grey	10/100
XTS 11-2	64100 14 506 11 -7		Black	10/100
XTS 11-3	64100 14 507 11 -4		White	10/100
XTS 12-1	64100 14 507 16 -9		Grey	10/100
XTS 12-2	64100 14 506 12 -4		Black	10/100
XTS 12-3	64100 14 507 12 -1		White	10/100

GLOBAL Trac Pro accessories

Power supply option in all connectors except XTS 21, XTS 23 and XTS 24.
 Available colours: -1 grey (RAL 7040), -2 black (RAL 9005), -3 white (RAL 9010).

Middle feed XTS 14

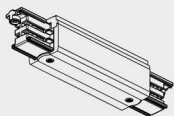

Type	EAN code	Polarity ridge	Surface treatment/colour/material	PCS/Package
XTS 14-1	64100 14 507 17-6		Grey	5/50
XTS 14-2	64100 14 506 14-8		Black	5/50
XTS 14-3	64100 14 507 14-5		White	5/50

Straight connector XTS 21

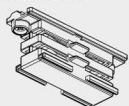

XTS 21-1	64100 14 507 18-3		Grey	10/100
XTS 21-2	64100 14 506 21-6		Black	10/100
XTS 21-3	64100 14 507 21-3		White	10/100

Flexible corner connector XTS 23

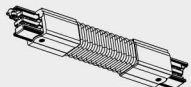

XTS 23-1	64100 14 507 20-6		Grey	5/25
XTS 23-2	64100 14 506 23-0		Black	5/25
XTS 23-3	64100 14 507 23-7		White	5/25

Adjustable corner connector XTS 24

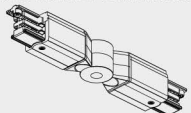

XTS 24-1	64100 14 507 19-0		Grey	5/25
XTS 24-2	64100 14 506 24-7		Black	5/25
XTS 24-3	64100 14 507 24-4		White	5/25

L-feed XTS 34, 35

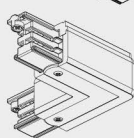

XTS 34-1	64100 14 507 25-1		Grey	5/25
XTS 34-2	64100 14 506 34-6		Black	5/25
XTS 34-3	64100 14 507 34-3		White	5/25
XTS 35-1	64100 14 507 26-8		Grey	5/25
XTS 35-2	64100 14 506 35-3		Black	5/25
XTS 35-3	64100 14 507 35-0		White	5/25

T-feed XTS 36, 37, 39, 40

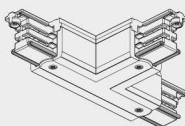

XTS 36-1	64100 14 507 27-5		Grey	5/25
XTS 36-2	64100 14 506 36-0		Black	5/25
XTS 36-3	64100 14 507 36-7		White	5/25
XTS 37-1	64100 14 507 28-2		Grey	5/25
XTS 37-2	64100 14 506 37-7		Black	5/25
XTS 37-3	64100 14 507 37-4		White	5/25
XTS 39-1	64100 14 507 30-5		Grey	5/25
XTS 39-2	64100 14 506 39-1		Black	5/25
XTS 39-3	64100 14 507 39-8		White	5/25
XTS 40-1	64100 14 507 31-2		Grey	5/25
XTS 40-2	64100 14 506 40-7		Black	5/25
XTS 40-3	64100 14 507 40-4		White	5/25

X-feed XTS 38

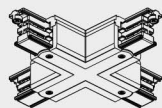

XTS 38-1	64100 14 507 29-9		Grey	5/25
XTS 38-2	64100 14 506 38-4		Black	5/25
XTS 38-3	64100 14 507 38-1		White	5/25

End cap XTS 41

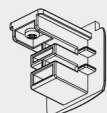

XTS 41-1	64100 14 507 32-9	Grey	10/100
XTS 41-2	64100 14 506 41-4	Black	10/100
XTS 41-3	64100 14 507 41-1	White	10/100

GLOBAL Trac Pro other parts

Available colours: -1 grey (RAL 7040), -2 black (RAL 9005), -3 white (RAL 9010).

Hook base XTAK 142, 144, 146

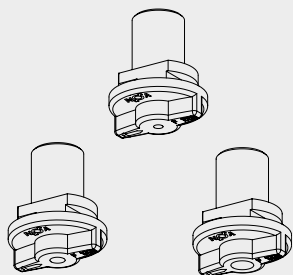

Type	EAN code		Surface treatment/colour/material	PCS/Package
XTAK 142-1	64100 14 507 43-5	For 2 mm wire/hook	Grey	50/250
XTAK 142-2	64100 14 506 42-1	For 2 mm wire/hook	Black	50/250
XTAK 142-3	64100 14 507 42-8	For 2 mm wire/hook	White	50/250
XTAK 144-1	64100 14 507 45-9	For M4 nut/rod	Grey	50/250
XTAK 144-2	64100 14 506 44-5	For M4 nut/rod	Black	50/250
XTAK 144-3	64100 14 507 44-2	For M4 nut/rod	White	50/250
XTAK 146-1	64100 14 507 47-3	For M6 nut/rod	Grey	50/250
XTAK 146-2	64100 14 506 46-9	For M6 nut/rod	Black	50/250
XTAK 146-3	64100 14 507 46-6	For M6 nut/rod	White	50/250

Hook XTAK 11



Tool XTSV 12

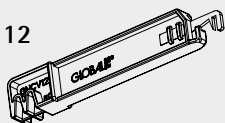

XTAK 11-1	64100 14 500 79-5	Hook 2 mm	Steel	100/5000
XTSV 12	64100 14 500 99-3	Bending tool for power wires	Blue	1/100

Cover plates

XTSF 10

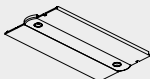

XTSF 30

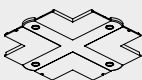

XTSF 40

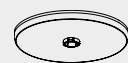

XTSF 10-1	64100 14 500 41-2	Cover plate for XTS11-14	Grey	1/100
XTSF 10-2	64100 14 506 61-2	Cover plate for XTS11-14	Black	1/100
XTSF 10-3	64100 14 507 61-9	Cover plate for XTS11-14	White	1/100
XTSF 30-1	64100 14 506 42-9	Cover plate for XTS34-40	Grey	1/100
XTSF 30-2	64100 14 506 62-9	Cover plate for XTS34-40	Black	1/100
XTSF 30-3	64100 14 507 62-6	Cover plate for XTS34-40	White	1/100
XTSF 40-1	64100 14 506 43-6	Outlet/cover plate for feeds	Grey	1/100
XTSF 40-2	64100 14 506 63-6	Outlet/cover plate for feeds	Black	1/100
XTSF 40-3	64100 14 507 63-3	Outlet/cover plate for feeds	White	1/100

Cover strip XTSP 11

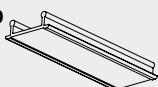

XTSP 11-2	64100 14 530 99-0	Cover strip, 3000 mm	Black	10/100
XTSP 11-3	64100 14 530 98-3	Cover strip, 3000 mm	White	10/100

Use of L- and T-accessories

Red line indicates polarity ridge

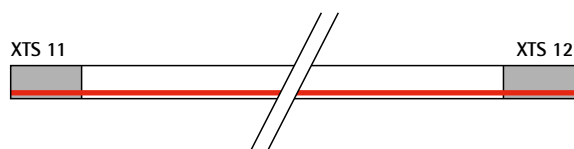

Floor view

