







lunoo[®]
the lighting company

PG-TRACK

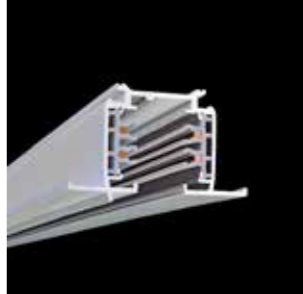

PG-TRACK OVERVIEW

		MOUNTED & SUSPENDED		RECESSED				
		FIXED	DALI	FIXED	DALI			
3-PHASE	PG-TRACK 3F	P4	PG-TRACK 3F DALI	P8	PG-TRACK IN 3F	P12	PG-TRACK IN 3F DALI	P16
								
1-PHASE			PG-TRACK 1F DALI	P20		PG-TRACK IN 1F DALI	P24	
								

PG-TRACK 3F

TOP VIEW

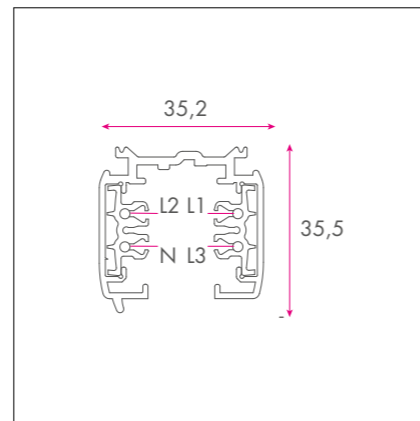
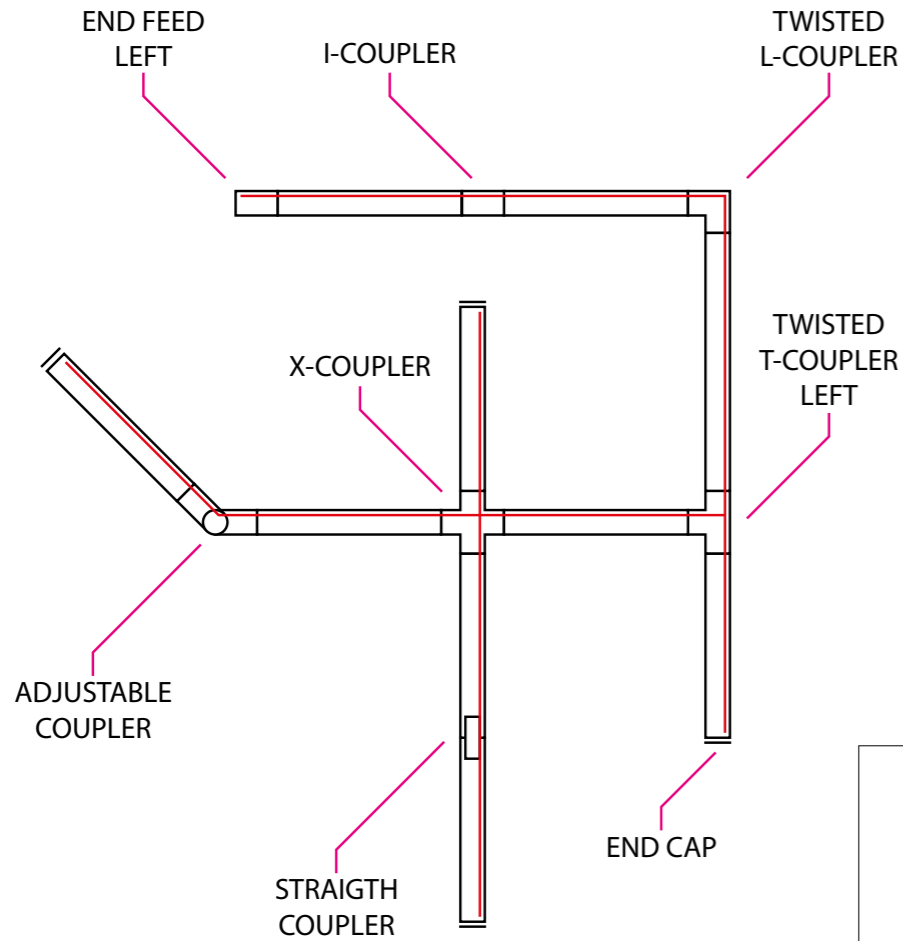

PG-TRACK 3F TRACK

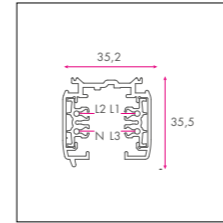

- mounted or suspended
- 3-phase
- max. load 30 kg/m
- 1,2 or 3 meters
- black, white or grey

SUSPENSION COUPLER CLAMP

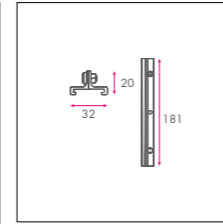

- connects 2 tracks mechanically
- black, white or grey

WIRE SUSPENSION CUP 5M

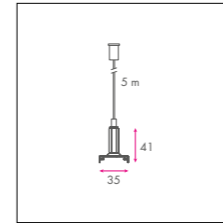
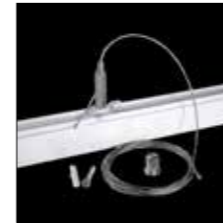

- suspension system for every ceiling type
- assembly of track clip, cable adjuster, steel wire and metal ceiling cup
- black, white or grey

WIRE SUSPENSION LOOP 5M

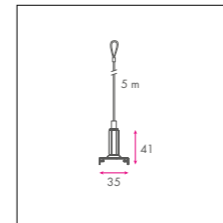

- suspension system for hooks
- assembly of track clip, cable adjuster and steel wire with loop
- black, white or grey

WIRE SUSPENSION STEEL DECK 5M

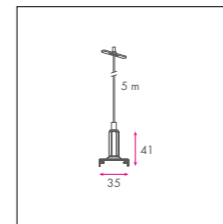

- suspension system for steel decks
- assembly of track clip, cable adjuster and steel wire with metal tab
- black, white or grey

T-PROFILE CLAMP

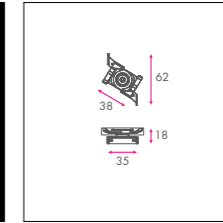

- mounting system for ceiling systems with a visible T-profile
- black, white or grey

SUSPENSION HOOK

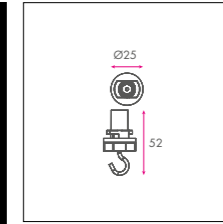

- metal hook for suspending items to a track
- black, white or grey

TRACK COVER 3M



- plastic cover to hide the inside of a track
- black or white

SCHUKO ADAPTER

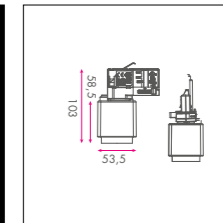

- power outlet for track
- black or white

PG-TRACK 3F

END FEED LEFT

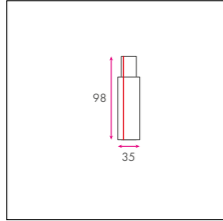

- power connection to profile
- left polarisation
- black, white or grey

END FEED RIGHT

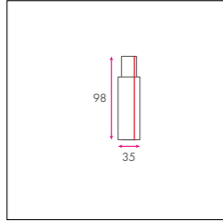

- power connection to profile
- right polarisation
- black, white or grey

STRAIGHT COUPLER

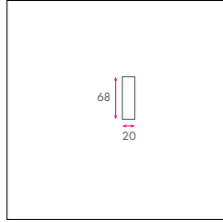

- electrical connection between 2 profiles
- black, white or grey

I-COUPLER

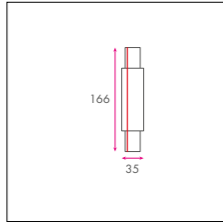

- electrical connection between 2 profiles
- optional power feed
- black, white or grey

ADJUSTABLE COUPLER

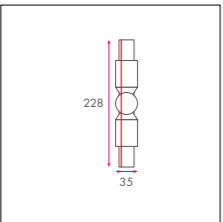

- electrical connection between 2 profiles
- adjustable angle of 180°
- black, white or grey

TWISTED L-COUPLER

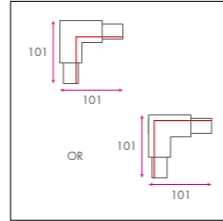

- electrical connection in a 90° angle
- can be transformed into both left and right polarisation
- optional power feed
- black, white or grey

TWISTED T-COUPLER LEFT

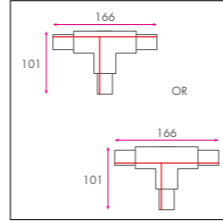

- electrical connection for 3 tracks in a T-configuration
- can be transformed into both left polarities
- optional power feed
- black, white or grey

TWISTED T-COUPLER RIGHT

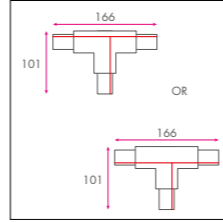

- electrical connection for 3 tracks in a T-configuration
- can be transformed into both right polarities
- optional power feed
- black, white or grey

X-COUPLER

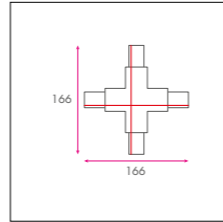

- electrical connection for 4 tracks in an X-configuration
- optional power feed
- black, white or grey

END CAP

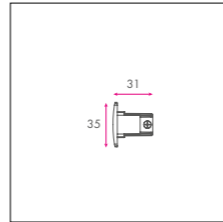

- to cover the end a track
- black, white or grey



PG-TRACK 3F DALI

TOP VIEW

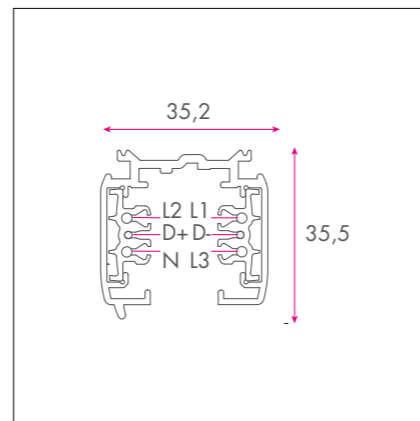
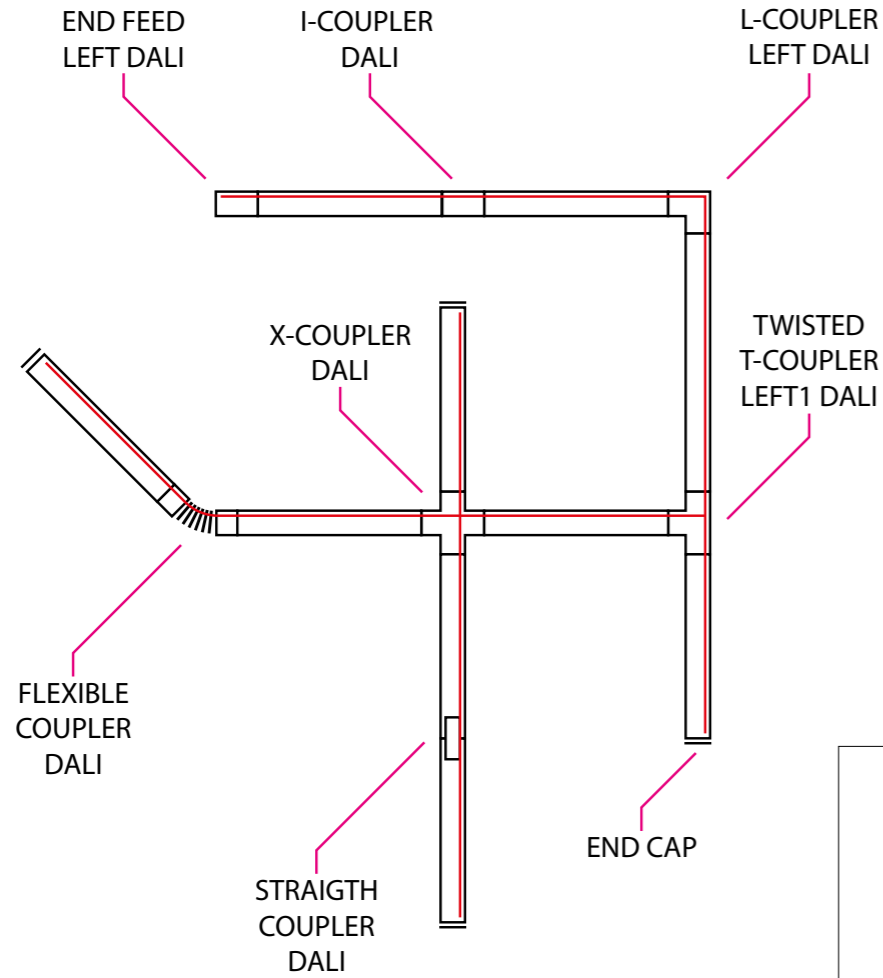

PG-TRACK 3F DALI TRACK

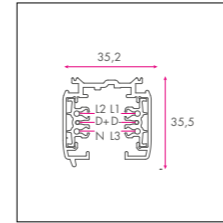

- mounted or suspended
- 3-phase
- dali
- max. load 30 kg/m
- 1,2 or 3 meters
- black, white or grey

SUSPENSION COUPLER CLAMP

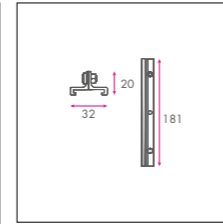

- connects 2 tracks mechanically
- black, white or grey

WIRE SUSPENSION CUP 5M

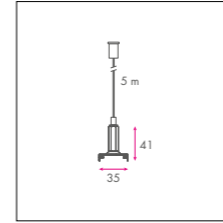

- suspension system for every ceiling type
- assembly of track clip, cable adjuster, steel wire and metal ceiling cup
- black, white or grey

WIRE SUSPENSION LOOP 5M

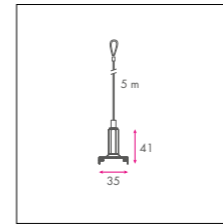

- suspension system for hooks
- assembly of track clip, cable adjuster and steel wire with loop
- black, white or grey

WIRE SUSPENSION STEEL DECK 5M

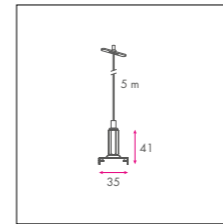

- suspension system for steel decks
- assembly of track clip, cable adjuster and steel wire with metal tab
- black, white or grey

T-PROFILE CLAMP

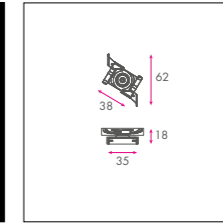

- mounting system for ceiling systems with a visible T-profile
- black, white or grey

SUSPENSION HOOK

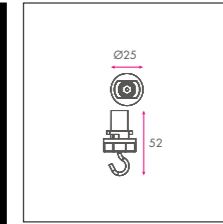

- metal hook for suspending items to a track
- black, white or grey

TRACK COVER 3M

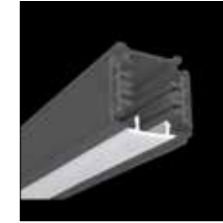

- plastic cover to hide the inside of a track
- black or white

SCHUKO ADAPTER

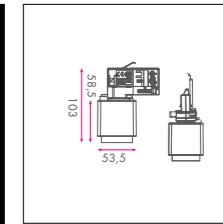

- power outlet for track
- black or white

PG-TRACK 3F DALI

END FEED LEFT

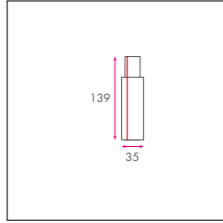

- power connection to profile
- left polarisation
- black, white or grey

END FEED RIGHT

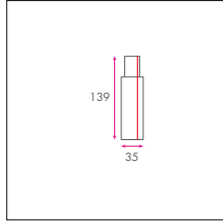

- power connection to profile
- right polarisation
- black, white or grey

STRAIGHT COUPLER

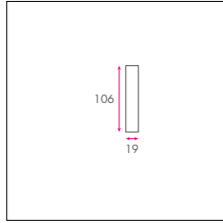

- electrical connection between 2 profiles
- black, white or grey

I-COUPLER

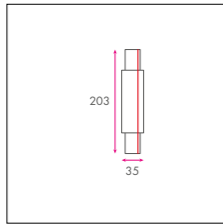

- electrical connection between 2 profiles
- optional power feed
- black, white or grey

FLEXIBLE COUPLER

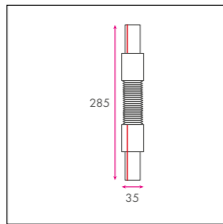

- electrical connection between 2 profiles
- adjustable angle of 180°
- black, white or grey

L-COUPLER LEFT

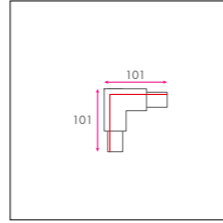

- electrical connection in a 90° angle
- left polarisation
- optional power feed
- black, white or grey

L-COUPLER RIGHT

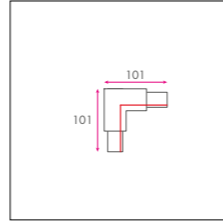

- electrical connection in a 90° angle
- right polarisation
- optional power feed
- black, white or grey

T-COUPLER LEFT1

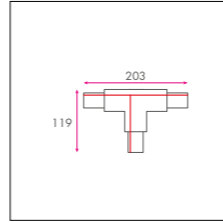

- electrical connection for 3 tracks in a T-configuration
- left polarisation
- optional power feed
- black, white or grey

T-COUPLER LEFT2

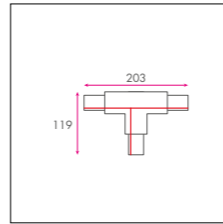

- electrical connection for 3 tracks in a T-configuration
- left polarisation
- optional power feed
- black, white or grey

T-COUPLER RIGHT1

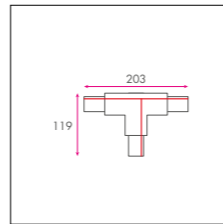

- electrical connection for 3 tracks in a T-configuration
- right polarisation
- optional power feed
- black, white or grey

T-COUPLER RIGHT2

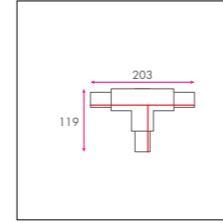

- electrical connection for 3 tracks in a T-configuration
- right polarisation
- optional power feed
- black, white or grey

X-COUPLER

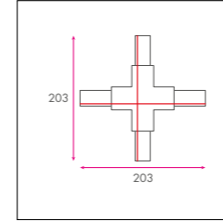

- electrical connection for 4 tracks in an X-configuration
- optional power feed
- black, white or grey

END CAP

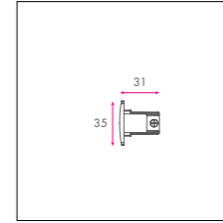

- to cover the end of a track
- black, white or grey



PG-TRACK IN 3F

TOP VIEW

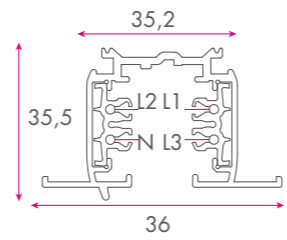
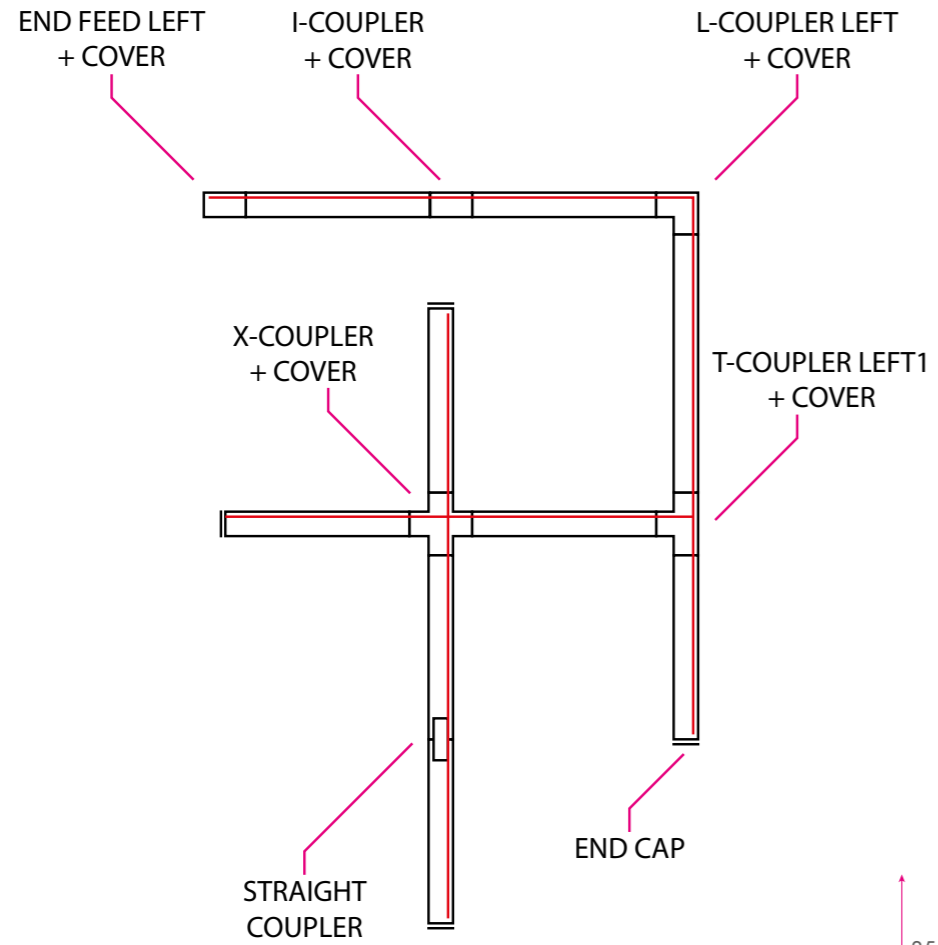

PG-TRACK IN 3F TRACK

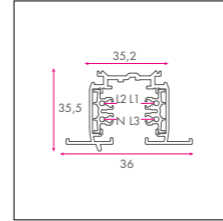

- recessed
- 3-phase
- max. load 30 kg/m
- 1,2 or 3 meters
- black, white or grey

SUSPENSION HOOK

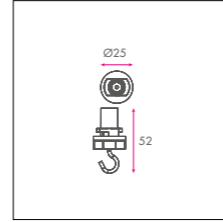

- metal hook for suspending items to a track
- black, white or grey

TRACK COVER 3M



- plastic cover to hide the inside of a track
- black or white

SCHUKO ADAPTER

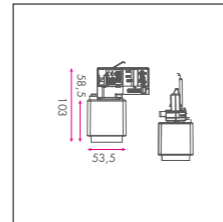

- power outlet for track
- black or white



PG-TRACK IN 3F

END FEED LEFT + COVER

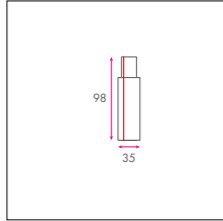

- power connection to profile
- cover included
- left polarisation
- black, white or grey

END FEED RIGHT + COVER

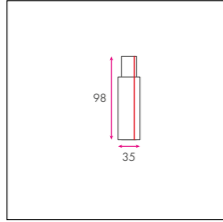

- power connection to profile
- cover included
- right polarisation
- black, white or grey

STRAIGHT COUPLER

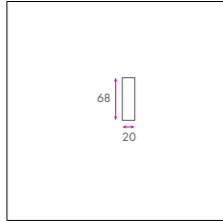

- electrical connection between 2 profiles
- black, white or grey

ICOUPLER + COVER

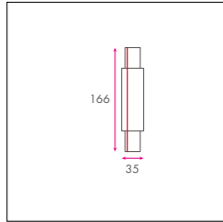

- electrical connection between 2 profiles
- cover included
- optional power feed
- black, white or grey

TWISTED L-COUPLER + COVER

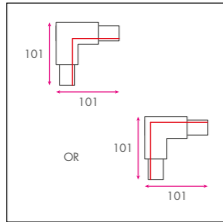

- electrical connection in a 90° angle
- cover included
- can be transformed into both left and right polarisation
- optional power feed
- black, white or grey

TWISTED T-COUPLER LEFT + COVER

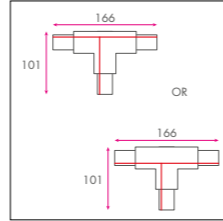
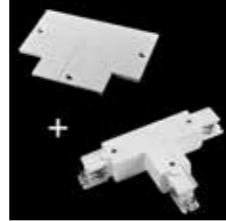

- electrical connection for 3 tracks in a T-configuration
- cover included
- can be transformed into both left polarities
- optional power feed
- black, white or grey

TWISTED T-COUPLER RIGHT + COVER

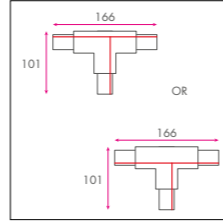

- electrical connection for 3 tracks in a T-configuration
- cover included
- can be transformed into both right polarities
- optional power feed
- black, white or grey

X-COUPLER + COVER

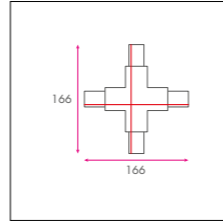

- electrical connection for 4 tracks in an X-configuration
- cover included
- optional power feed
- black, white or grey

END CAP

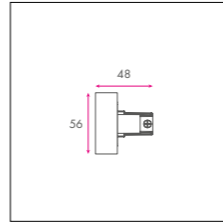

- to cover the end of a track
- black, white or grey



PG-TRACK IN 3F DALI

TOP VIEW

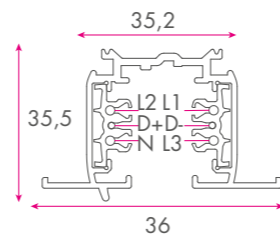
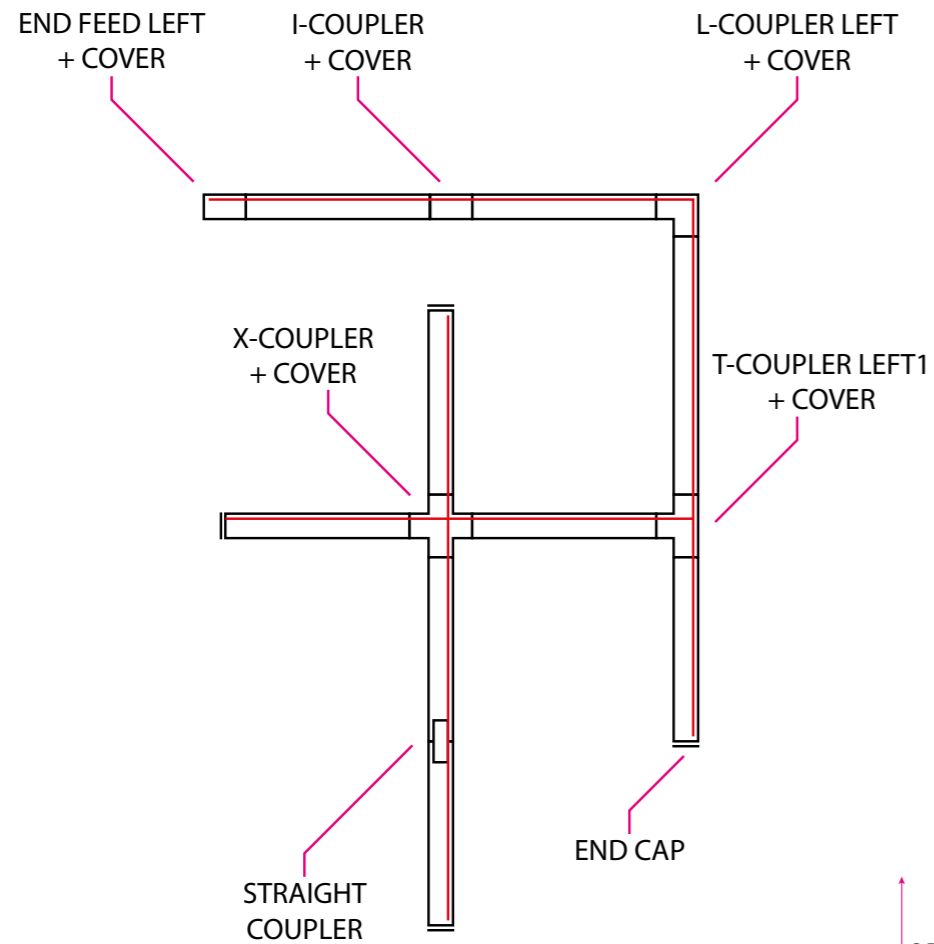

PG-TRACK IN 3F DALI TRACK

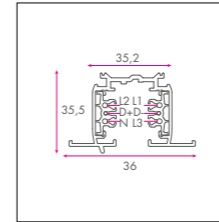

- recessed
- 3-phase
- dali
- max. load 30 kg/m
- 1,2 or 3 meters
- black, white or grey

SUSPENSION HOOK

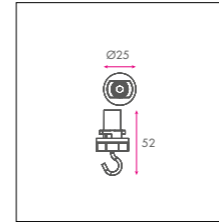

- metal hook for suspending items to a track
- black, white or grey

TRACK COVER 3M



- plastic cover to hide the inside of a track
- black or white

SCHUKO ADAPTER

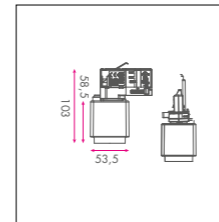

- power outlet for track
- black or white



PG-TRACK IN 3F DALI

END FEED LEFT DALI + COVER

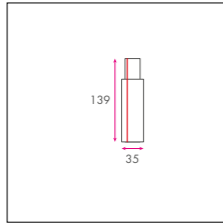

- power connection to profile
- cover included
- left polarisation
- black, white or grey

END FEED RIGHT DALI + COVER

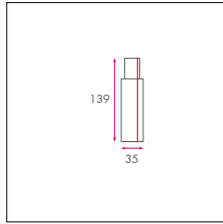
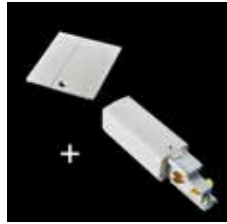

- power connection to profile
- cover included
- right polarisation
- black, white or grey

STRAIGHT COUPLER DALI

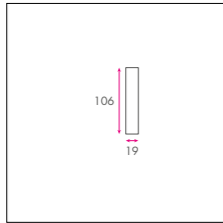

- electrical connection between 2 profiles
- black, white or grey

ICOUPLER DALI + COVER

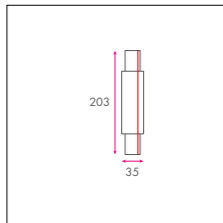

- electrical connection between 2 profiles with power feed
- cover included
- optional power feed
- black, white or grey

L-COUPLER LEFT DALI + COVER

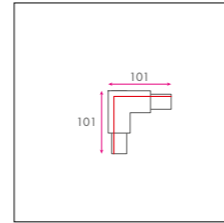

- electrical connection in a 90° angle
- cover included
- left polarisation
- optional power feed
- black, white or grey

L-COUPLER RIGHT DALI + COVER

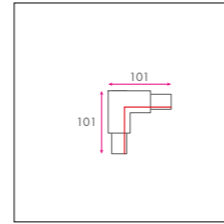

- electrical connection in a 90° angle
- cover included
- right polarisation
- optional power feed
- black, white or grey

T-COUPLER LEFT1 DALI + COVER

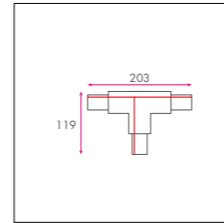

- electrical connection for 3 tracks in a T-configuration
- cover included
- left polarisation
- optional power feed
- black, white or grey

T-COUPLER LEFT2 DALI + COVER

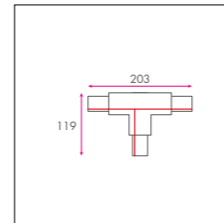

- electrical connection for 3 tracks in a T-configuration
- cover included
- left polarisation
- optional power feed
- black, white or grey

T-COUPLER RIGHT1 DALI + COVER

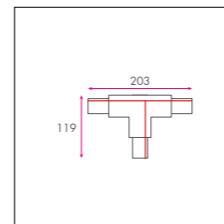

- electrical connection for 3 tracks in a T-configuration
- cover included
- right polarisation
- optional power feed
- black, white or grey

T-COUPLER RIGHT2 DALI + COVER

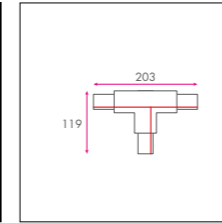
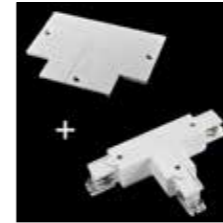

- electrical connection for 3 tracks in a T-configuration
- cover included
- right polarisation
- optional power feed
- black, white or grey

X-COUPLER DALI + COVER

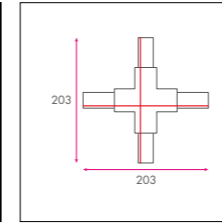
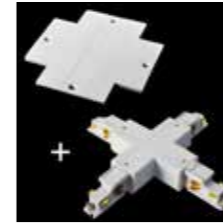

- electrical connection for 4 tracks in an X-configuration
- cover included
- optional power feed
- black, white or grey

END CAP

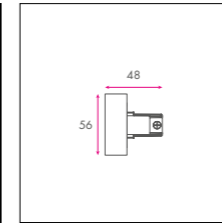
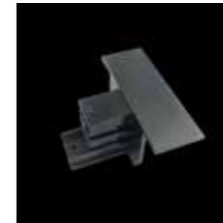

- to cover the end of a track
- black, white or grey



PG-TRACK 1F DALI

TOP VIEW

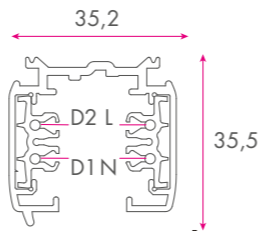
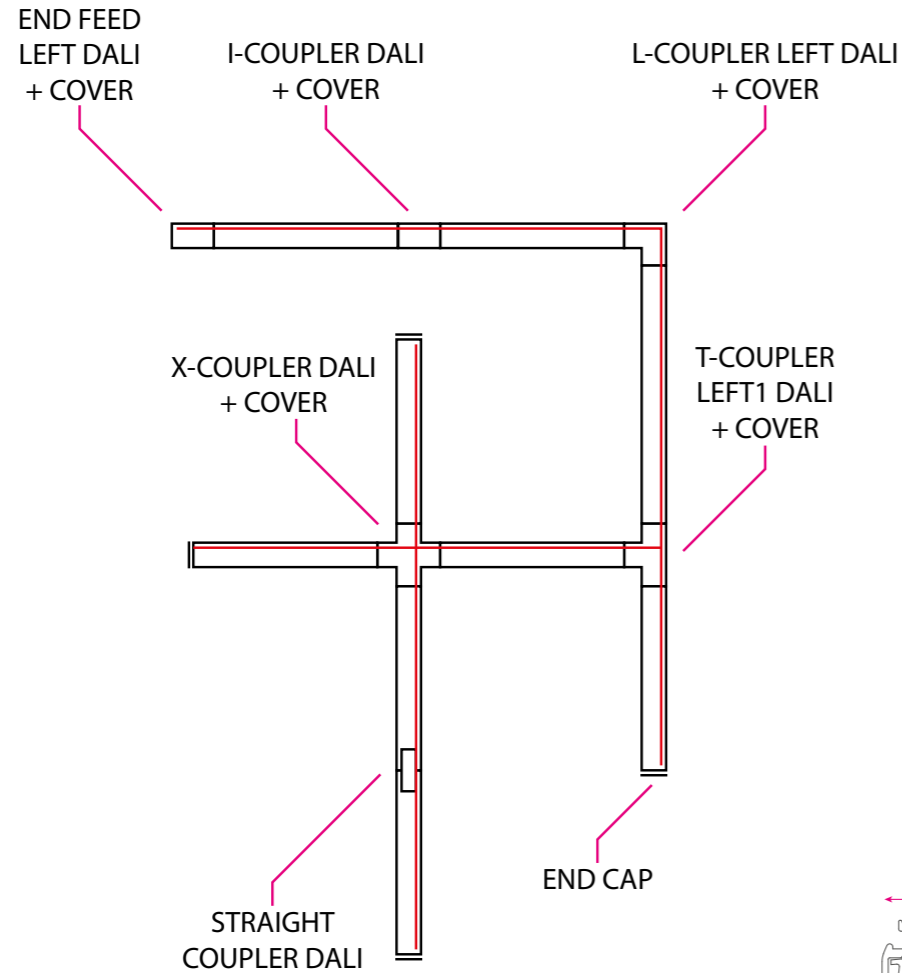

PG-TRACK 1F TRACK DALI

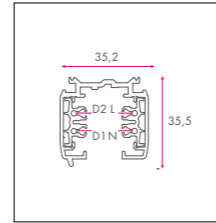

- mounted or suspended
- 1-phase
- dali
- max. load 30 kg/m
- 1,2 or 3 meters
- black, white or grey

SUSPENSION COUPLER CLAMP

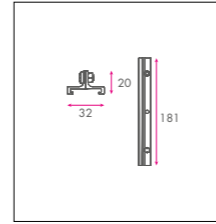

- connects 2 tracks mechanically
- black, white or grey

WIRE SUSPENSION CUP 5M

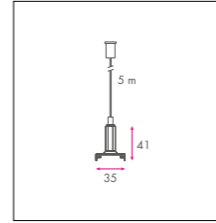

- suspension system for every ceiling type
- assembly of track clip, cable adjuster, steel wire and metal ceiling cup
- black, white or grey

WIRE SUSPENSION LOOP 5M

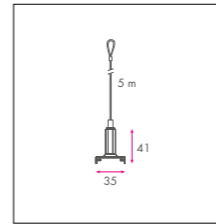

- suspension system for hooks
- assembly of track clip, cable adjuster and steel wire with loop
- black, white or grey

WIRE SUSPENSION STEEL DECK 5M

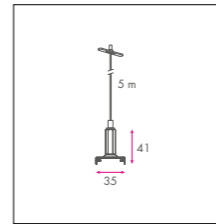

- suspension system for steel decks
- assembly of track clip, cable adjuster and steel wire with metal tab
- black, white or grey

T-PROFILE CLAMP

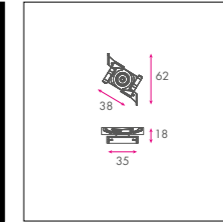

- mounting system for ceiling systems with a visible T-profile
- black, white or grey

SUSPENSION HOOK

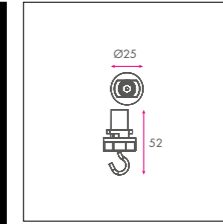

- metal hook for suspending items to a track
- black, white or grey

TRACK COVER 3M



- plastic cover to hide the inside of a track
- black or white

PG-TRACK 1F DALI

END FEED LEFT DALI

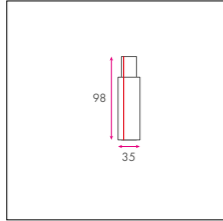

- power connection to profile
- left polarisation
- black, white or grey

END FEED RIGHT DALI

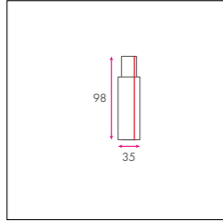

- power connection to profile
- right polarisation
- black, white or grey

STRAIGHT COUPLER DALI

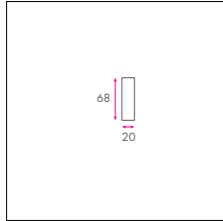

- electrical connection between 2 profiles
- black, white or grey

ICOUPLER DALI

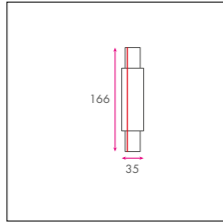

- electrical connection between 2 profiles with power feed
- optional power feed
- black, white or grey

FLEXIBLE COUPLER DALI

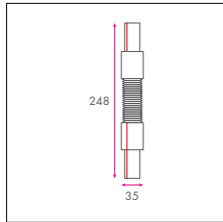

- electrical connection between 2 profiles
- adjustable angle of 180°
- black, white or grey

L-COUPLER LEFT DALI

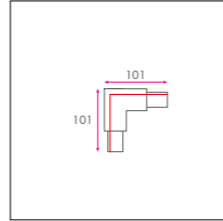

- electrical connection in a 90° angle
- left polarisation
- optional power feed
- black, white or grey

L-COUPLER RIGHT DALI

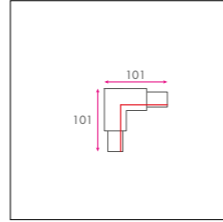

- electrical connection in a 90° angle
- right polarisation
- optional power feed
- black, white or grey

T-COUPLER LEFT1 DALI

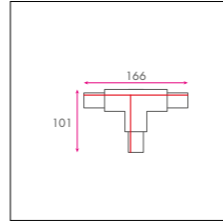

- electrical connection for 3 tracks in a T-configuration
- left polarisation
- optional power feed
- black, white or grey

T-COUPLER LEFT2 DALI

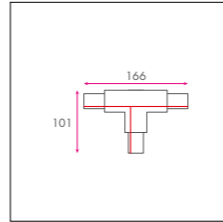

- electrical connection for 3 tracks in a T-configuration
- left polarisation
- optional power feed
- black, white or grey

T-COUPLER RIGHT1 DALI

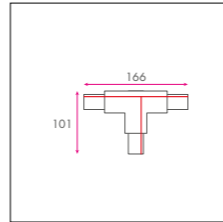

- electrical connection for 3 tracks in a T-configuration
- right polarisation
- optional power feed
- black, white or grey

T-COUPLER RIGHT2 DALI

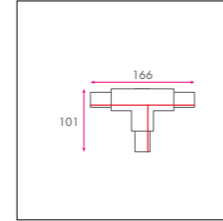

- electrical connection for 3 tracks in a T-configuration
- right polarisation
- optional power feed
- black, white or grey

X-COUPLER DALI

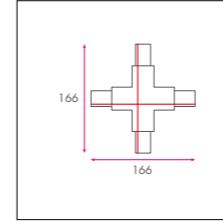

- electrical connection for 4 tracks in an X-configuration
- optional power feed
- black, white or grey

END CAP

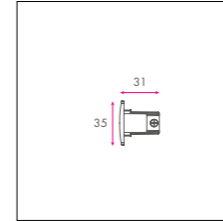

- to cover the end of a track
- black, white or grey



PG-TRACK IN 1F DALI

TOP VIEW

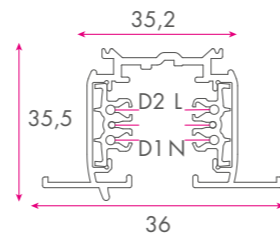
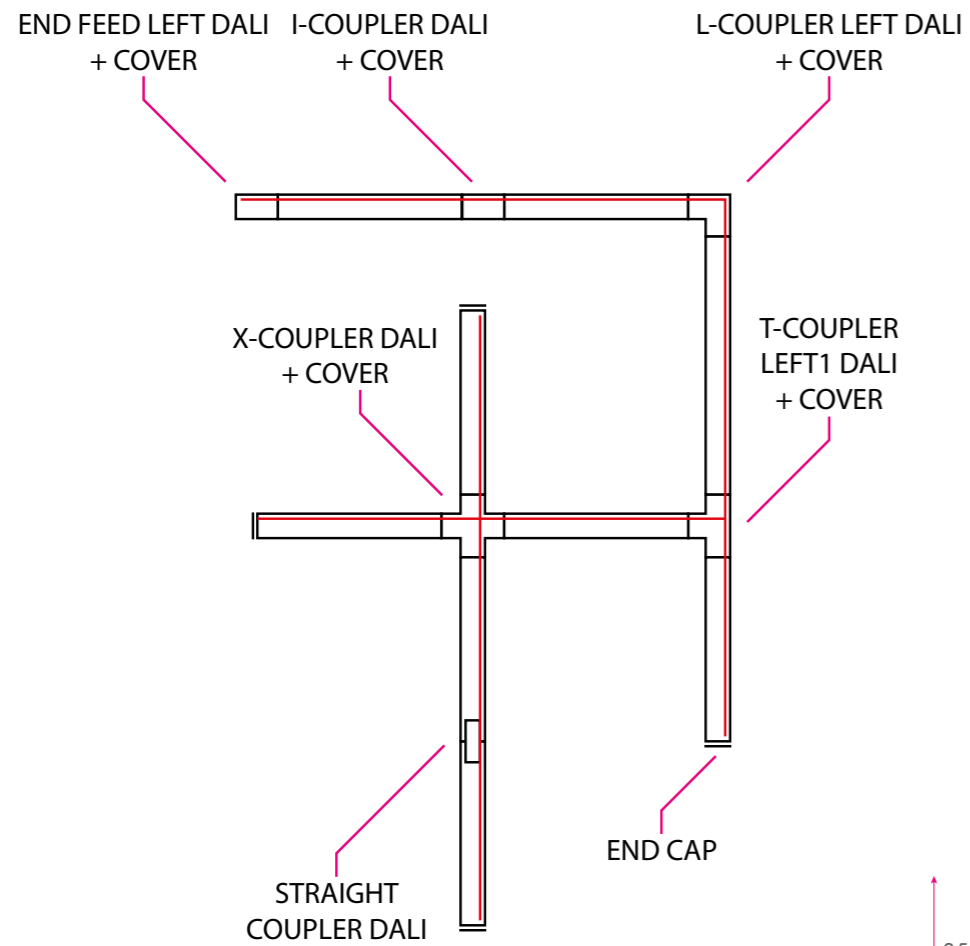

PG-TRACK IN 1F TRACK DALI

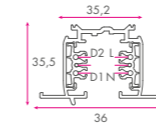
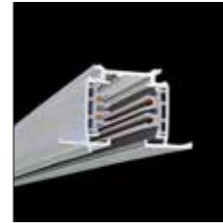

- 1,2 or 3 meters
- black, white or grey

SUSPENSION HOOK

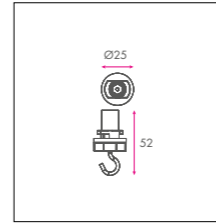

- black, white or grey
- 5 meters of steel cable
- twist and lock on the profile

TRACK COVER 3M



- black, white or grey



PG-TRACK IN 1F DALI

END FEED LEFT DALI + COVER

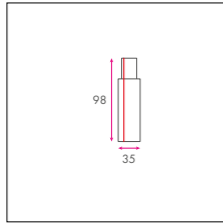
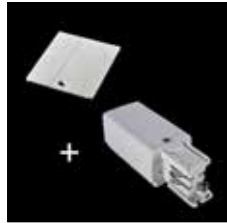

- power connection to profile
- left polarisation
- cover included
- black, white or grey

L-COUPLER LEFT DALI + COVER

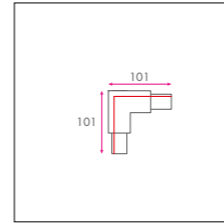

- electrical connection in a 90° angle
- left polarisation
- optional power feed
- cover included
- black, white or grey

T-COUPLER RIGHT2 DALI + COVER

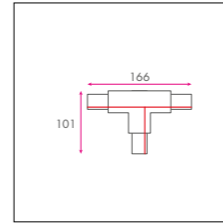

- electrical connection for 3 tracks in a T-configuration
- right polarisation
- optional power feed
- cover included
- black, white or grey

END FEED RIGHT DALI + COVER

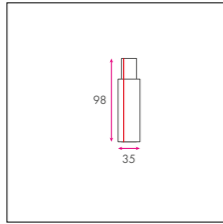

- power connection to profile
- right polarisation
- cover included
- black, white or grey

L-COUPLER RIGHT DALI

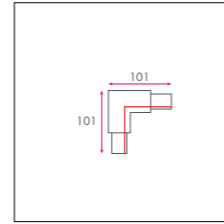

- electrical connection in a 90° angle
- right polarisation
- optional power feed
- cover included
- black, white or grey

X-COUPLER DALI + COVER

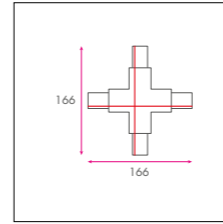
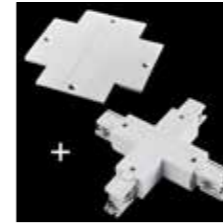

- electrical connection for 4 tracks in an X-configuration
- optional power feed
- cover included
- black, white or grey

STRAIGHT COUPLER DALI

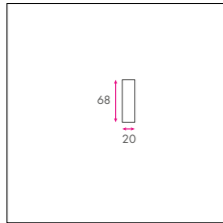

- electrical connection between 2 profiles
- black, white or grey

T-COUPLER LEFT1 DALI + COVER

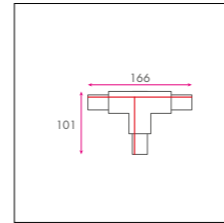

- electrical connection for 3 tracks in a T-configuration
- left polarisation
- optional power feed
- cover included
- black, white or grey

END CAP

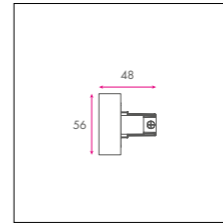
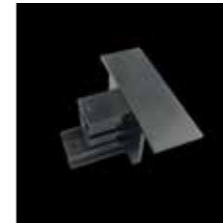

- to cover the end of a track
- black, white or grey

I-COUPLER DALI + COVER

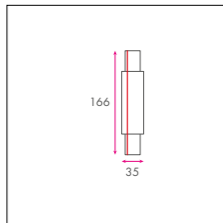

- electrical connection between 2 profiles with power feed
- optional power feed
- cover included
- black, white or grey

T-COUPLER LEFT2 DALI + COVER

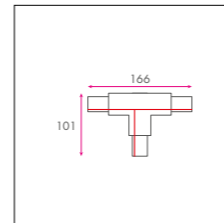

- electrical connection for 3 tracks in a T-configuration
- left polarisation
- optional power feed
- cover included
- black, white or grey

T-COUPLER RIGHT1 DALI

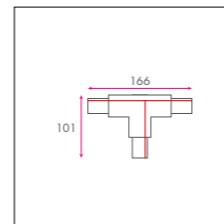

- electrical connection for 3 tracks in a T-configuration
- right polarisation
- optional power feed
- cover included
- black, white or grey





Lunoo NV

Wantestraat 14
8780 Oostrozebeke
+32 56 676 100
info@lunoo.eu

lunoo[®]
the lighting company

"Lighting solutions for professional projects"