

## LT-SL-series

### UNIQUE SELLING POINTS

IK08

BODY IN DIE-CAST  
LOW-COPPER-  
CONTENT  
ALUMINIUM EN AB  
47100 FOR EXCELLENT  
RESISTANCE TO  
CORROSION

4-MM-THICK TRANSPARENT EXTRA-CLEAR  
GLASS WITH VITRIFIED  
SERIGRAPHY, HIGH  
TRANSMITTANCE TO ENSURE  
CHROMATIC UNIFORMITY AND  
TEMPERED FOR EXCELLENT  
RESISTANCE  
TO KNOCKS AND SCRATCHES

5 kinds of light distribution



RAL FINISH  
ON REQUEST

IP66

SUITABLE  
FOR OUTDOOR  
APPLICATIONS

316 stainless  
steel fasteners

SCALED, ADJUSTABLE  
BRACKET

1/2" NPT thread. A fully sealed  
spherical grommet allows infinite  
adjustment capabilities

20 installation  
combinations



## LT-SL -series

10-20W, optical range 15°-60°

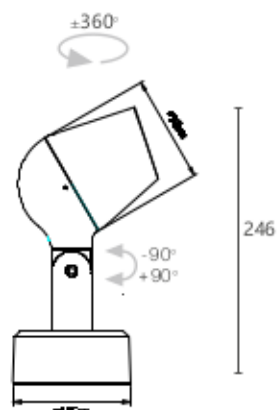



 kg 1.2
 

  

 RAL

<b>POWER / POWER SUPPLY</b>	10W / 15W / 20W AC220V-240V or (120-277V) Powder coating: bronze (DC12-24V)
<b>CRI</b>	CRI >90
<b>LED COLOUR</b>	- 2700K - 3000K - 4000K
<b>OPTICS</b>	- optical range 15° / 23° / 36° / 60° / 40°*70°
<b>LUMEN OUTPUT AT SOURCE</b>	1000lm / 1500lm / 2000lm (4000K, CRI 90)
<b>NO. AND TYPE OF LED</b>	1 COB high-intensity power LED 3-step MacAdam, 50000h L90 B10 (Ta 25°C)
<b>MATERIAL</b>	body in Powder coating anticorodal aluminium screen in tempered, transparent extra-clear glass
<b>POWER CABLES</b>	neoprene cable 3x0.75
<b>MOUNTING</b>	surface mounted (ceiling, wall, ground, spike, pole)
<b>NOTES</b>	Honeycomb louvre available on request

## LT-SL -series

30-60W, optical range 15°-60°

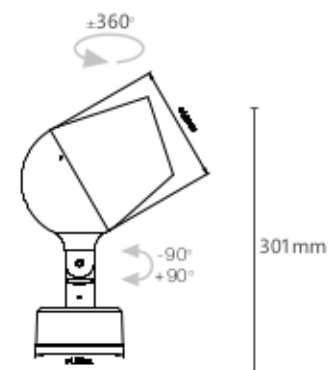

CE   kg 2 IP66 IK08  
A A+ A+  RAL

<b>POWER / POWER SUPPLY</b>	30W / 40W / 60W AC220V-240V or (120-277V) Powder coating: bronze (DC12-24V)
<b>CRI</b>	CRI >90
<b>LED COLOUR</b>	- 2700K - 3000K - 4000K
<b>OPTICS</b>	- optical range 15° / 23° / 36° / 60° / 40°70°
<b>LUMEN OUTPUT AT SOURCE</b>	3000lm / 4000lm / 6000lm (4000K, CRI 90)
<b>NO. AND TYPE OF LED</b>	1 COB high-intensity power LED 3-step MacAdam, 50000h L90 B10 (Ta 25°C)
<b>MATERIAL</b>	body in Powder coating anticorodal aluminium screen in tempered, transparent extra-clear glass
<b>POWER CABLES</b>	neoprene cable 3x0.75
<b>MOUNTING</b>	surface mounted (ceiling, wall, ground, spike, pole)
<b>NOTES</b>	Honeycomb louvre available on request

## LT-SL -series

9/36W, optical range 15°-60°



<b>POWER / POWER SUPPLY</b>	9W DC24V Powder coating: bronze
<b>LED COLOUR</b>	- RGBW  DMX512
<b>OPTICS</b>	- optical range 15° / 23° / 36° / 60°
<b>LUMEN OUTPUT AT SOURCE</b>	536 lm, R: 83 lm G: 150 lm B: 60 lm W: 243 lm (4000K)
<b>NO. AND TYPE OF LED</b>	2 RGBW LED groups 50000h L90 B10 (Ta 25°C)
<b>MATERIAL</b>	body in Powder coating anticorrosion aluminium screen in tempered, transparent extra-clear glass
<b>POWER CABLES</b>	neoprene cable 3x0.3mm <sup>2</sup> (DMX line) and 2x1mm <sup>2</sup> (DC line)Ø6.3 mm
<b>MOUNTING</b>	surface mounted (ceiling, wall, ground, spike, pole)
<b>NOTES</b>	Honeycomb louvre available on request

<b>POWER / POWER SUPPLY</b>	36W DC24V Powder coating: bronze
<b>LED COLOUR</b>	- RGBW  DMX512
<b>OPTICS</b>	- optical range 15° / 23° / 36° / 60°
<b>LUMEN OUTPUT AT SOURCE</b>	2148 lm, R: 336 lm G: 594 lm B: 238 lm W: 980 lm (4000K)
<b>NO. AND TYPE OF LED</b>	8 RGBW LED groups 50000h L90 B10 (Ta 25°C)
<b>MATERIAL</b>	body in Powder coating anticorrosion aluminium screen in tempered, transparent extra-clear glass
<b>POWER CABLES</b>	neoprene cable 3x0.3mm <sup>2</sup> (DMX line) and 2x1mm <sup>2</sup> (DC line)Ø6.3 mm
<b>MOUNTING</b>	surface mounted (ceiling, wall, ground, spike, pole)
<b>NOTES</b>	Honeycomb louvre available on request



## ACCESSORIES

### Options ACCESSORIES

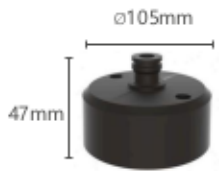

SB Surface Base Mount



JB Junction Box(USA)

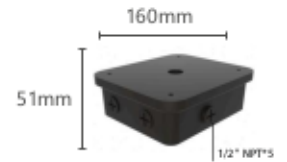
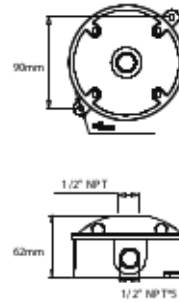

WM Wall Mount(USA)



Extension arm L: 500mm( $\varnothing$  25mm)  
Material: AL

\* Can be customized in different lengths

### OPTICAL ACCESSORIES

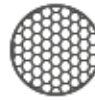

Honeycomb louvre  
built into the  
lighting fixture

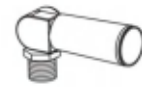

Photocell option  
Swivel photocell available

## LT-SL -series

10-20W, optical range 15°-60°





 kg 2
 IP66 IK08  

 RAL

<b>POWER / POWER SUPPLY</b>	10W / 15W / 20W AC220V-240V or (120-277V) Powder coating: bronze (DC12-24V)
<b>CRI</b>	CRI >90
<b>LED COLOUR</b>	- 2700K - 3000K - 4000K
<b>OPTICS</b>	- optical range 15° / 23° / 36° / 60° / 40°*70°
<b>LUMEN OUTPUT AT SOURCE</b>	1000lm / 1500lm / 2000lm (4000K, CRI 90)
<b>NO. AND TYPE OF LED</b>	1 COB high-intensity power LED 3-step MacAdam, 50000h L90 B10 (Ta 25°C)
<b>MATERIAL</b>	body in Powder coating anticorrosional aluminium screen in tempered, transparent extra-clear glass
<b>POWER CABLES</b>	neoprene cable 3x0.75
<b>MOUNTING</b>	surface mounted (ceiling, wall, ground, spike, pole)
<b>NOTES</b>	Honeycomb louvre available on request

## ACCESSORIES

### Options ACCESSORIES

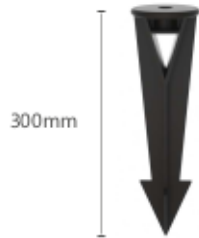

GS Ground Stake 1.0  
Material: PC

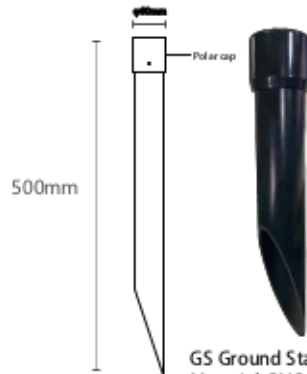

GS Ground Stake 1.1  
Material: PVC

\* Can be customized in different lengths

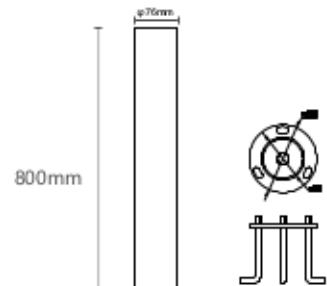

Ground Stake 1.2  
Material: steel

\* Can be customized in different lengths



Optional  
junction box



Extension arm L:500mm(φ 25mm)  
Material: AL

\* Can be customized in different lengths

### OPTICAL ACCESSORIES

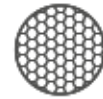

Honeycomb louvre  
built into the  
lighting fixture

## LT-SL -series

30-60W, optical range 15°-60°





 kg 2
 IP66 IK08  

 RAL

<b>POWER / POWER SUPPLY</b>	10W / 15W / 20W AC220V-240V or (120-277V) Powder coating: bronze (DC12-24V)
<b>CRI</b>	CRI >90
<b>LED COLOUR</b>	- 2700K - 3000K - 4000K
<b>OPTICS</b>	- optical range 15° / 23° / 36° / 60° / 40°70°
<b>LUMEN OUTPUT AT SOURCE</b>	1000lm / 1500lm / 2000lm (4000K, CRI 90)
<b>NO. AND TYPE OF LED</b>	1 COB high-intensity power LED 3-step MacAdam, 50000h L90 B10 (Ta 25°C)
<b>MATERIAL</b>	body in Powder coating anticorrosional aluminium screen in tempered, transparent extra-clear glass
<b>POWER CABLES</b>	neoprene cable 3x0.75
<b>MOUNTING</b>	surface mounted (ceiling, wall, ground, spike, pole)
<b>NOTES</b>	Honeycomb louvre available on request



## ACCESSORIES

---

### Options ACCESSORIES



TM Tree Mount 1.0  
Material: Polyester + aluminum  
length:2m

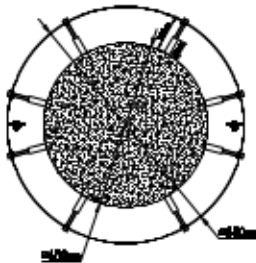
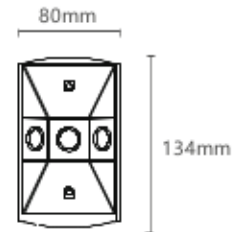
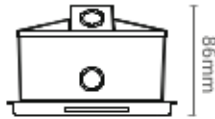

TRM Tree ring Mount 1.1  
Material: 304 stainless steel

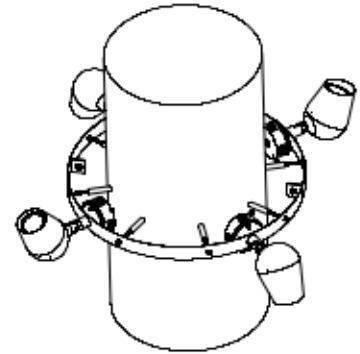
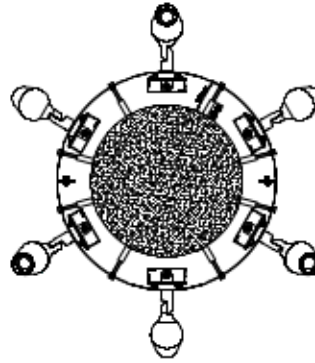

## LT-SL -series

30-60W, optical range 15°-60°



CE  IP66 IK08  
A A+ A+  RAL

<b>POWER / POWER SUPPLY</b>	30W/pcs 40W/pcs 60W/pcs Powder coating: bronze	AC220V-240V or (120-277V) (DC12-24V)
<b>CRI</b>	CRI >90	
<b>LED COLOUR</b>	- 2700K - 3000K - 4000K	
<b>OPTICS</b>	- optical range 15° / 23° / 36° / 60° / 40°70°	
<b>LUMEN OUTPUT AT SOURCE</b>	3000lm / 4000lm / 6000lm (4000K, CRI 90)	
<b>NO. AND TYPE OF LED</b>	1 COB high-intensity power LED 3-step MacAdam, 50000h L90 B10 (Ta 25°C)	
<b>MATERIAL</b>	body in Powder coating anticorrosional aluminium screen in tempered, transparent extra-clear glass	
<b>POWER CABLES</b>	neoprene cable 3x0.75	
<b>MOUNTING</b>	surface mounted (ceiling, wall, ground, spike, pole)	
<b>NOTES</b>	Honeycomb louvre available on request	

### Options ACCESSORIES

Flange (Unilateral)



Flange (Bilateral)

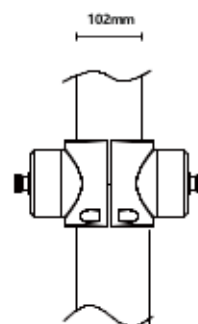

Material: die-cast aluminum

## LT-SL -series

30-60W, optical range 15°-60°



CE  IP66 IK08  
A A+ A+  RAL

<b>POWER / POWER SUPPLY</b>	30W/pcs 40W/pcs 60W/pcs Powder coating: bronze	AC220V-240V or (120-277V) (DC12-24V)
<b>CRI</b>	CRI >90	
<b>LED COLOUR</b>	- 2700K - 3000K - 4000K	
<b>OPTICS</b>	- optical range 15° / 23° / 36° / 60° / 40°*70°	
<b>LUMEN OUTPUT AT SOURCE</b>	3000lm / 4000lm / 6000lm (4000K, CRI 90)	
<b>NO. AND TYPE OF LED</b>	1 COB high-intensity power LED 3-step MacAdam, 50000h L90 B10 (Ta 25°C)	
<b>MATERIAL</b>	body in Powder coating anticorodal aluminium screen in tempered, transparent extra-clear glass	
<b>POWER CABLES</b>	neoprene cable 3x0.75	
<b>MOUNTING</b>	surface mounted (ceiling, wall, ground, spike, pole)	
<b>NOTES</b>	Honeycomb louvre available on request	

### Options ACCESSORIES



Arm for pole mounting  
Material: die-cast aluminum

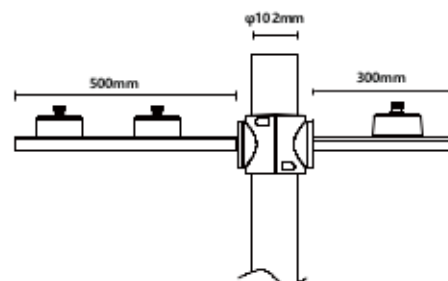

## LT-SL -series

30-60W, optical range 15°-60°



CE  IP66 IK08  
A A+ A+  RAL

<b>POWER / POWER SUPPLY</b>	30W/pcs 40W/pcs 60W/pcs	AC220V-240V or (120-277V) (DC12-24V)
	Powder coating: bronze	
<b>CRI</b>	CRI >90	
<b>LED COLOUR</b>	- 2700K - 3000K - 4000K	
<b>OPTICS</b>	- optical range 15° / 23° / 36° / 60° / 40°70°	
<b>LUMEN OUTPUT AT SOURCE</b>	3000lm / 4000lm / 6000lm (4000K, CRI 90)	
<b>NO. AND TYPE OF LED</b>	1 COB high-intensity power LED 3-step MacAdam, 50000h L90 B10 (Ta 25°C)	
<b>MATERIAL</b>	body in Powder coating anticorodal aluminium screen in tempered, transparent extra-clear glass	
<b>POWER CABLES</b>	neoprene cable 3x0.75	
<b>MOUNTING</b>	surface mounted (ceiling, wall, ground, spike, pole)	
<b>NOTES</b>	Honeycomb louvre available on request	

### Options ACCESSORIES



**Coupler**  
Material: Aluminum alloy  
Suitable for φ60-200mm pole

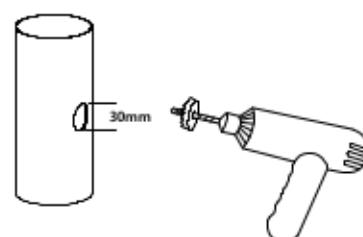

## LT-SL -series

30-60W, optical range 15°-60°



CE IP66 IK08  
A A+ A+

<b>POWER / POWER SUPPLY</b>	30W/pcs 40W/pcs 60W/pcs Powder coating: bronze	AC220V-240V or (120-277V) (DC12-24V)
<b>CRI</b>	CRI >90	
<b>LED COLOUR</b>	- 2700K - 3000K - 4000K	
<b>OPTICS</b>	- optical range 15° / 23° / 36° / 60° / 40°70°	
<b>LUMEN OUTPUT AT SOURCE</b>	3000lm / 4000lm / 6000lm (4000K, CRI 90)	
<b>NO. AND TYPE OF LED</b>	1 COB high-intensity power LED 3-step MacAdam, 50000h L90 B10 (Ta 25°C)	
<b>MATERIAL</b>	body in Powder coating anticorrosional aluminium screen in tempered, transparent extra-clear glass	
<b>POWER CABLES</b>	neoprene cable 3x0.75	
<b>MOUNTING</b>	surface mounted (ceiling, wall, ground, spike, pole)	
<b>NOTES</b>	Honeycomb louvre available on request	

### Options ACCESSORIES

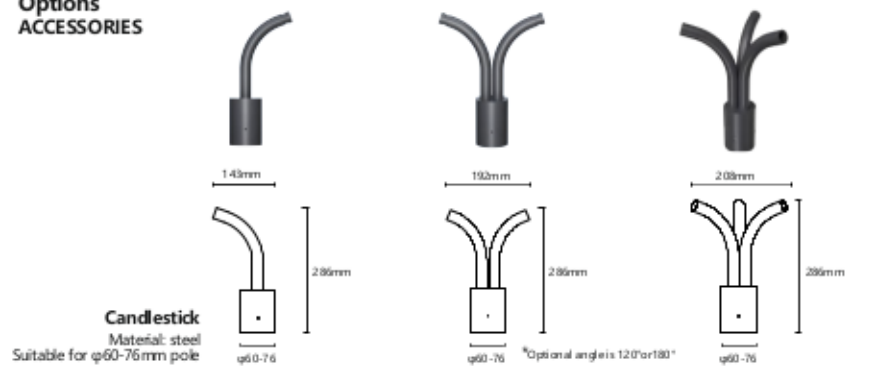

## LT-SL -series

LED BOLLARD LIGHT

20W, optical range 60° or 40\*70°

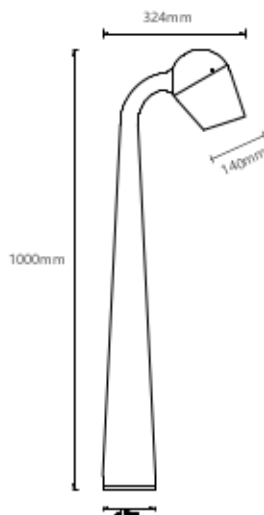

CE kg 2 IP66 IK08  
A A+ A+ RAL

<b>POWER / POWER SUPPLY</b>	20W Powder coating: bronze	AC220V-240V or (120-277V) (DC12-24V)
<b>CRI</b>	CRI >90	
<b>LED COLOUR</b>	- 2700K - 3000K - 4000K	
<b>OPTICS</b>	- optical range 60° / 40*70°	
<b>LUMEN OUTPUT AT SOURCE</b>	2000lm (4000K, CRI 90)	
<b>NO. AND TYPE OF LED</b>	1 COB high-intensity power LED 3-step MacAdam, 50000h L90 B10 (Ta 25°C)	
<b>MATERIAL</b>	body in Powder coating anticorodal aluminium screen in tempered, transparent extra-clear glass	
<b>POWER CABLES</b>	neoprene cable 3x0.75	
<b>MOUNTING</b>	buried base or flange plate	
<b>NOTES</b>	Honeycomb louvre available on request	

### Options ACCESSORIES

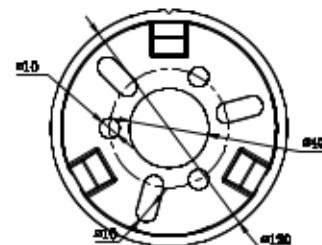

#### Flange plate

Material: Die-cast aluminum

# LT-SL -series

LED BOLLARD LIGHT

7W, optical range 15°

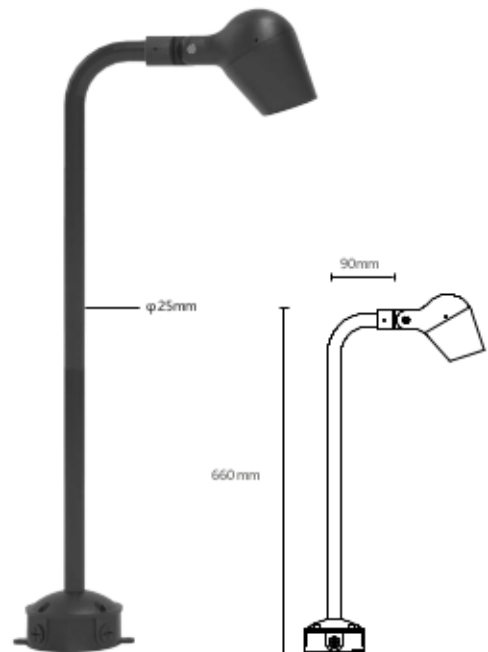

<b>POWER / POWER SUPPLY</b>	7W Powder coating: bronze	AC220V-240V or (120-277V) (DC12-24V)
<b>CRI</b>	CRI >90	
<b>LED COLOUR</b>	- 2700K - 3000K - 4000K	
<b>OPTICS</b>	- optical range 15° / 23° / 36° / 60° / 40°70°	
<b>LUMEN OUTPUT AT SOURCE</b>	700lm (4000K, CRI 90)	
<b>NO. AND TYPE OF LED</b>	1 COB high-intensity power LED 3-step MacAdam, 50000h L90 B10 (Ta 25°C)	
<b>MATERIAL</b>	body in Powder coating anticorodal aluminium screen in tempered, transparent extra-clear glass	
<b>POWER CABLES</b>	neoprene cable 3x0.75	
<b>MOUNTING</b>	surface mounted (ceiling, wall, ground, spike, pole)	
<b>NOTES</b>	Honeycomb louvre available on request	

### Accessories



Extension arm



JB Junction Box

**Material:** Aluminum profile  
**Specification:** Thickness 4mm,  $\varnothing$ 25mm  
 \*Length can be customized

# PROJECTORS

FOR OUTDOOR APPLICATIONS

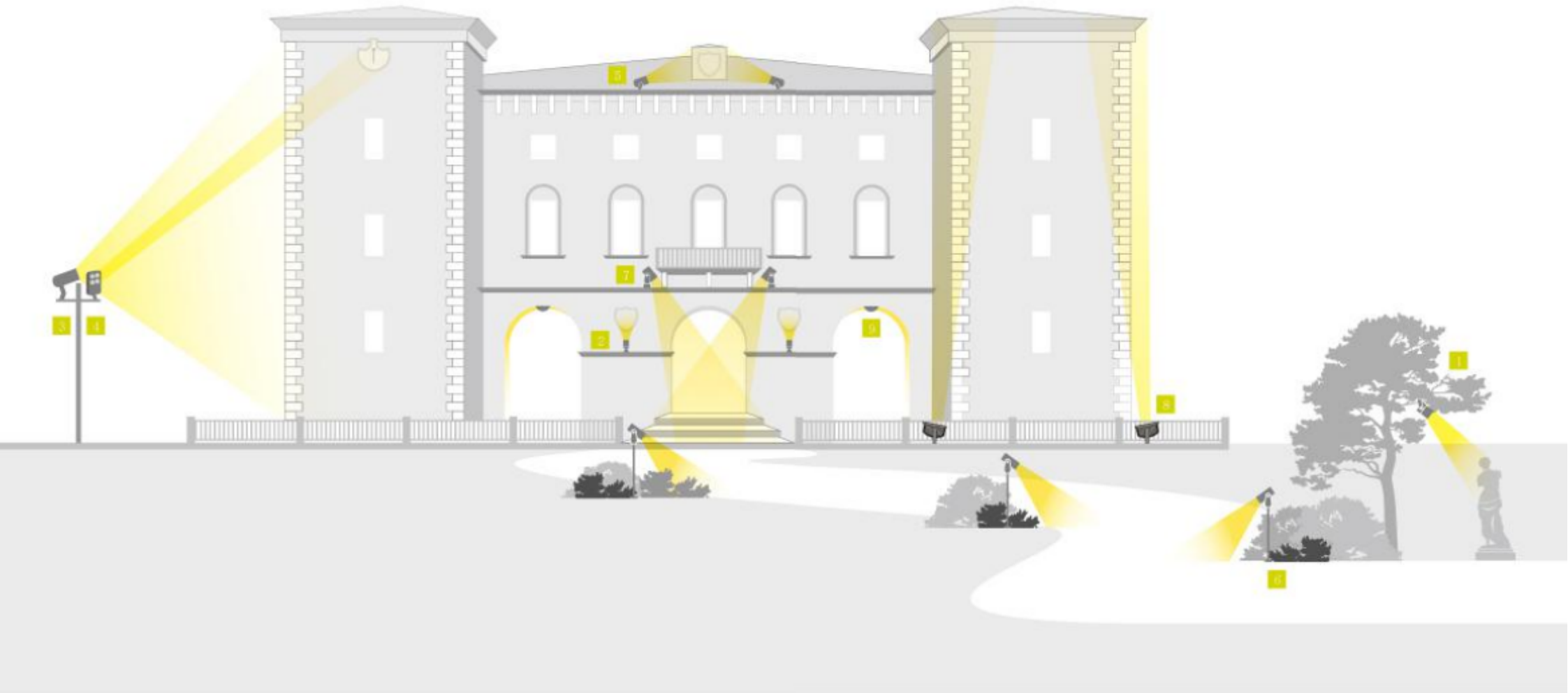



## LT-SL-10W-3000K

### S - 15° CRI 90

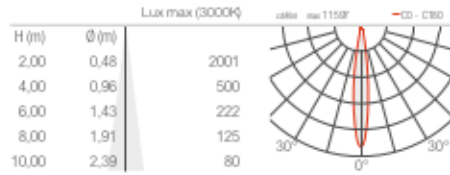

### L - 36° CRI 90

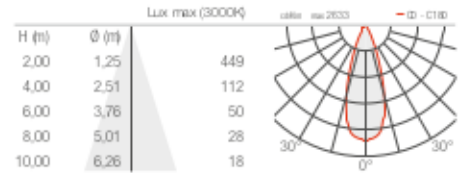

### M - 20° CRI 90

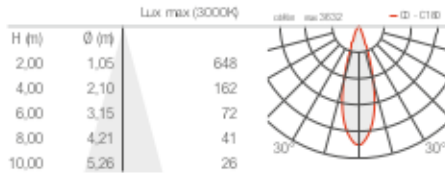

### K - 60° CRI 90

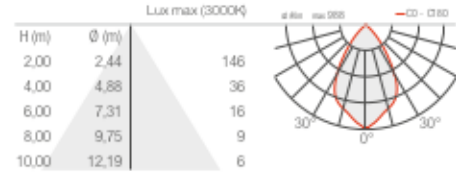

## LT-SL-15W-3000K

### S - 15° CRI 90

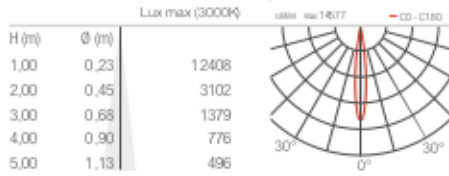

### L - 36° CRI 90

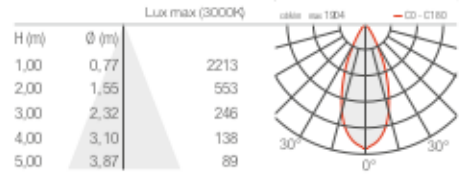

### M - 20° CRI 90

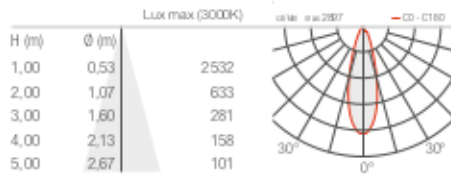

### J - 60° CRI 90

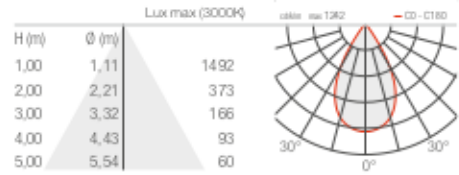

## LT-SL-20W-3000K

### S - 15° CRI 90

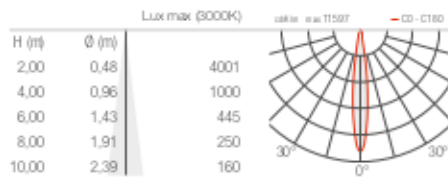

### L - 36° CRI 90

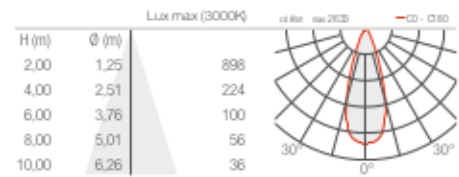

### M - 20° CRI 90

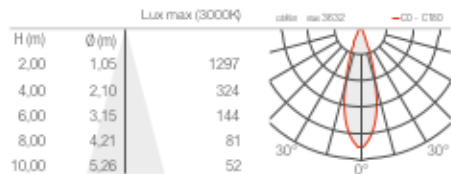

### K - 60° CRI 90

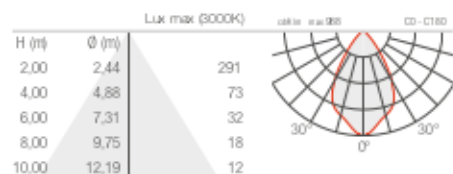

## LT-SL-30W-3000K

### S - 15° CRI 90

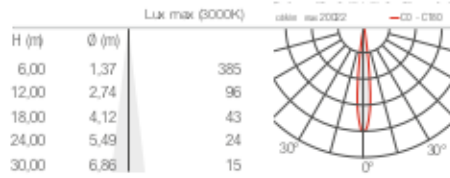

### M - 23° CRI 90

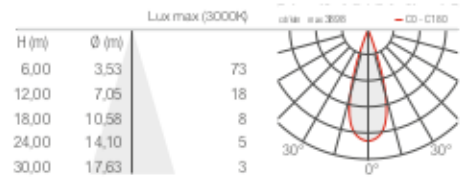

### L - 36° CRI 90

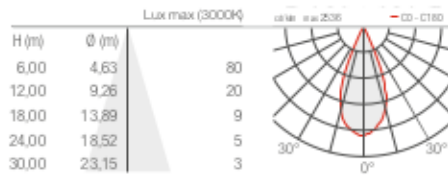

## LT-SL-40W-3000K

### S - 15° CRI 90

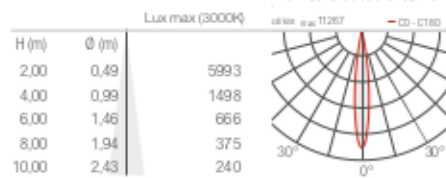

### M - 23° CRI 90

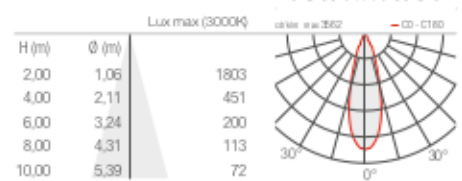

### L - 36° CRI 90

