

# Mine første tal

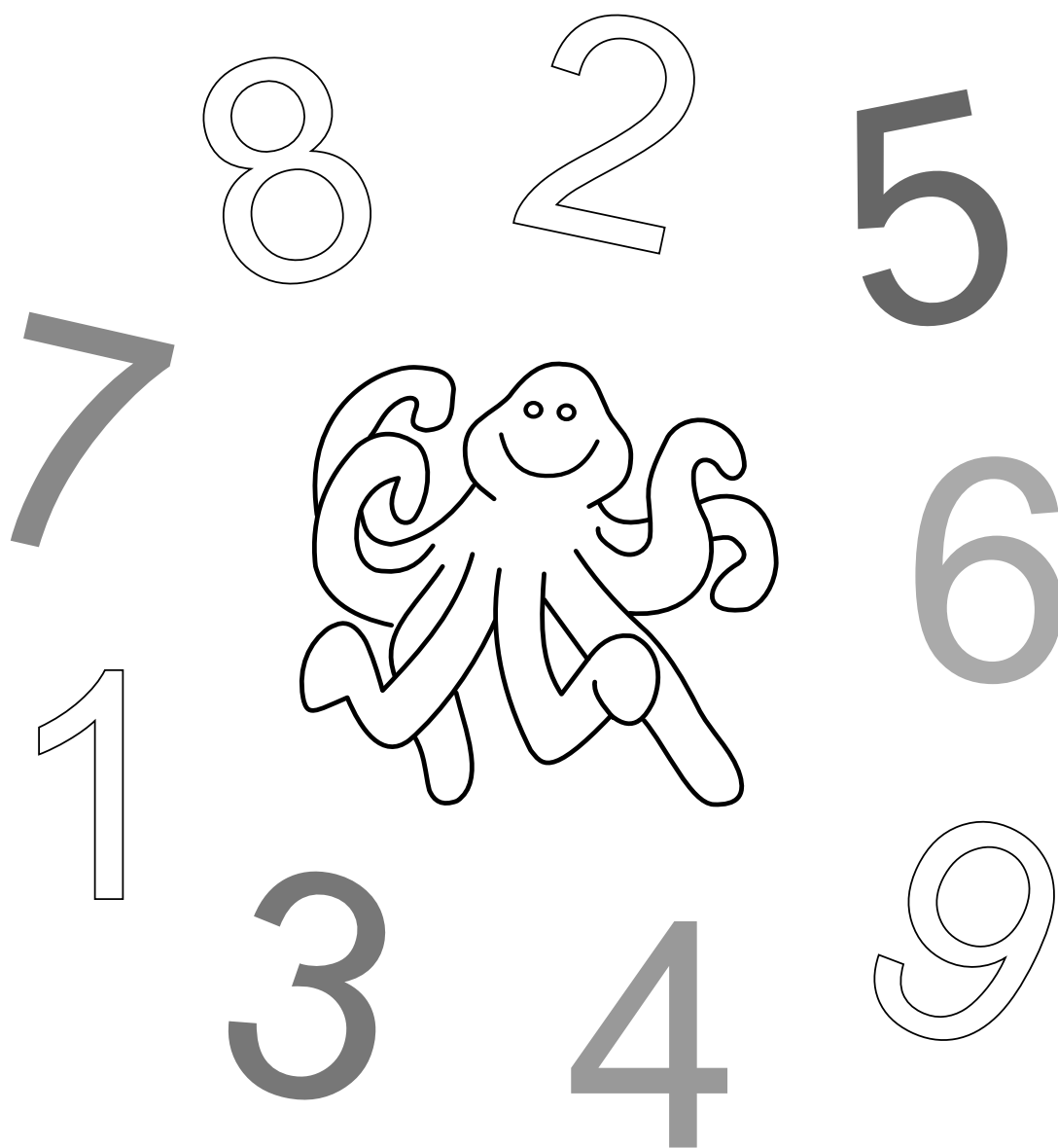

1 2 3 4 5 6 7 8 9

Start i cirklen med nummer 1 - følg derefter pilene:

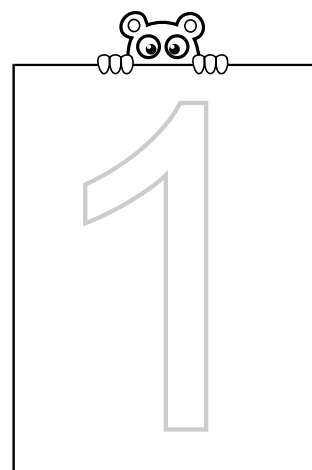
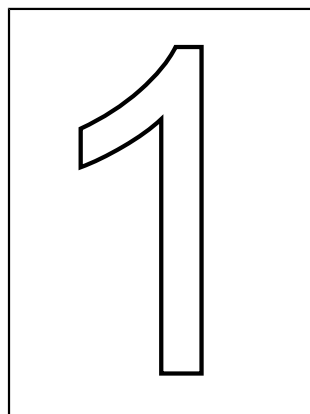
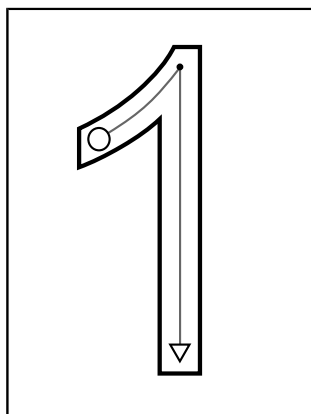
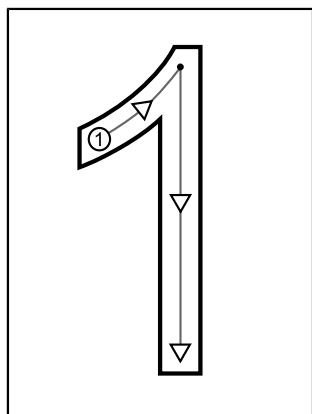

Skriv tallet 1 på disse linier:

1 1 1 1 1

\_\_\_\_\_

1

\_\_\_\_\_

1

\_\_\_\_\_

1

\_\_\_\_\_

1

\_\_\_\_\_

1

\_\_\_\_\_

Farv 1 etage på højhuset:

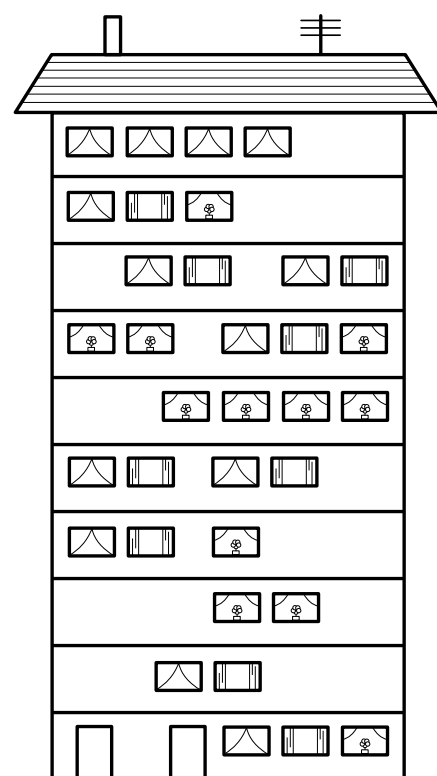

Farv 1 figur herunder:



Start i cirklen med nummer 1 - følg derefter pilene:

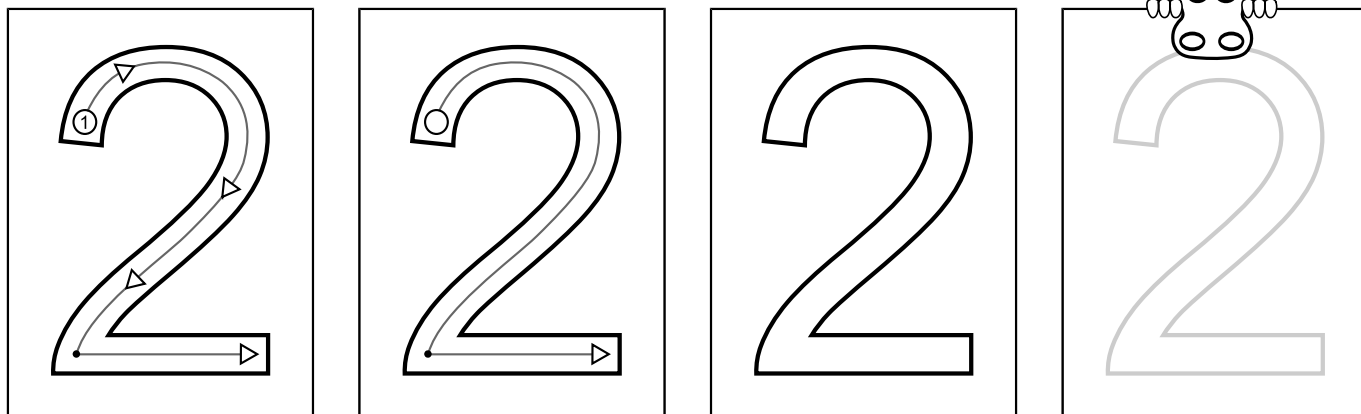

Skriv tallet 2 på disse linier:

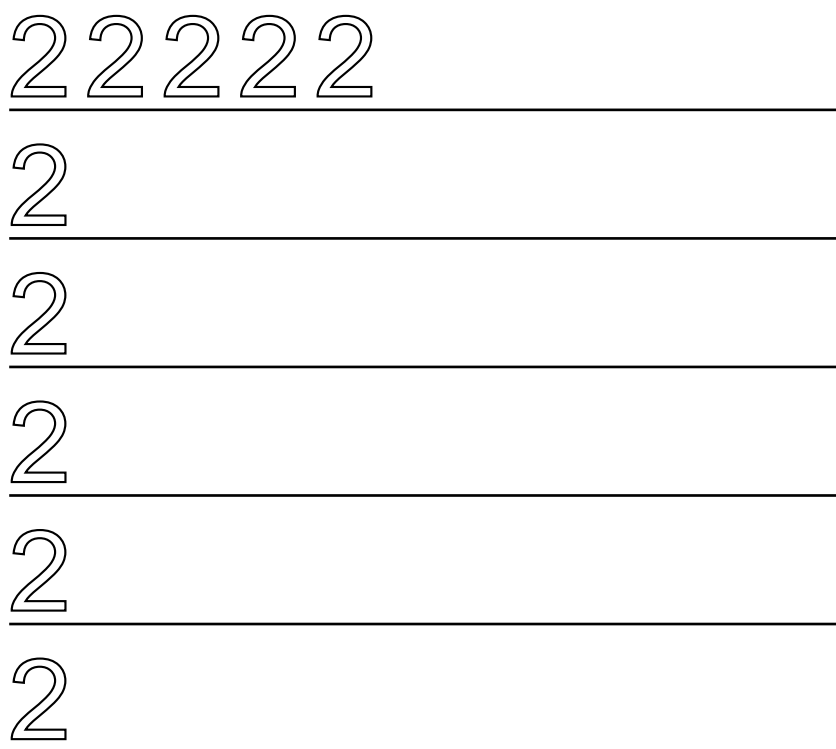

Farv 2 etager på højhuset:

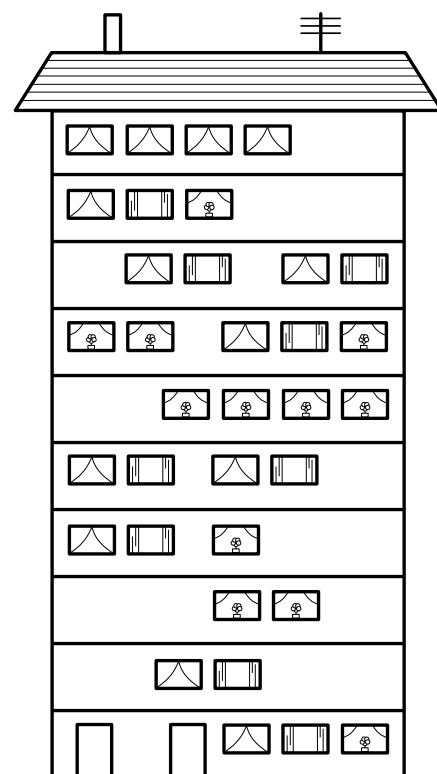

Farv 2 figurer herunder:

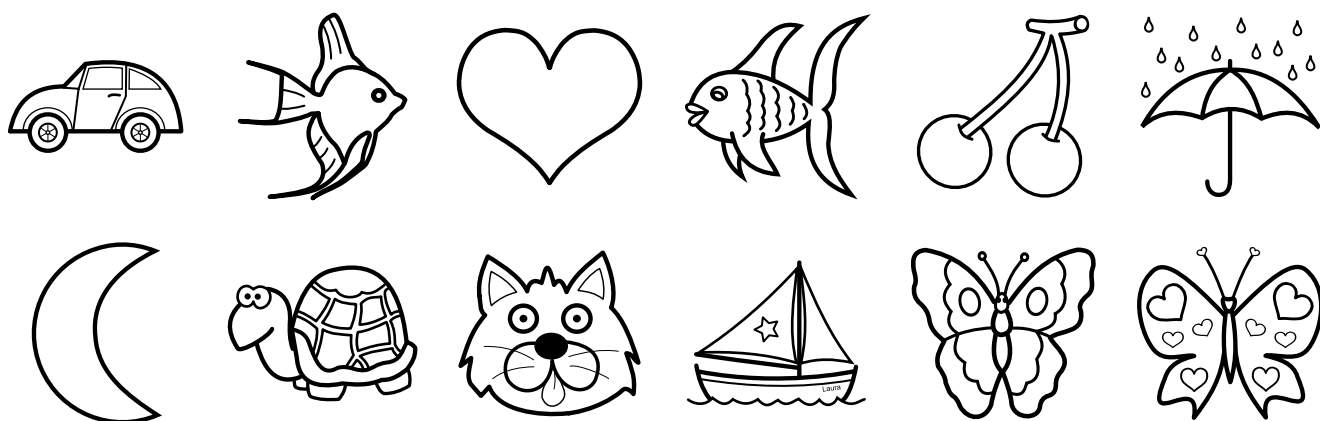

Start i cirklen med nummer 1 - følg derefter pilene:

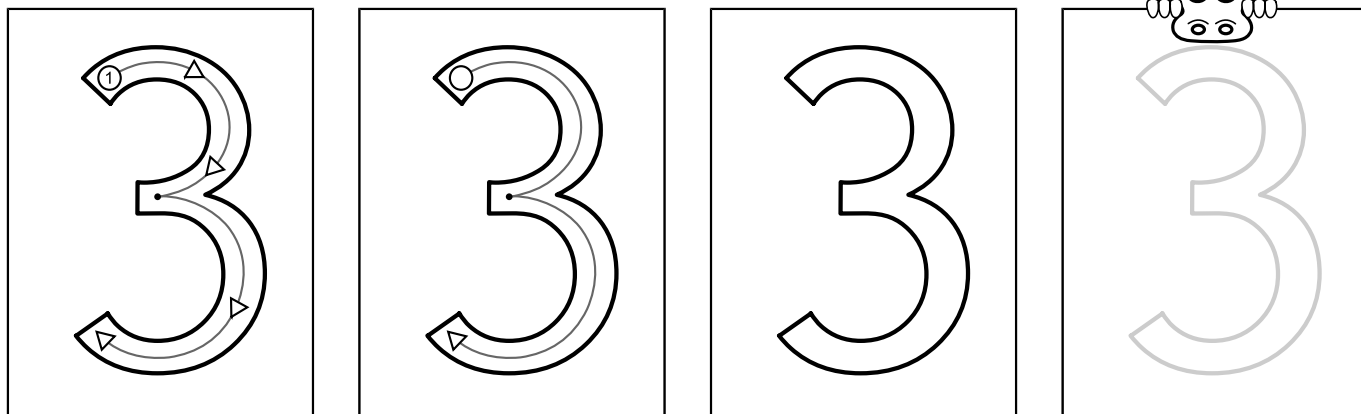

Skriv tallet 3 på disse linier:

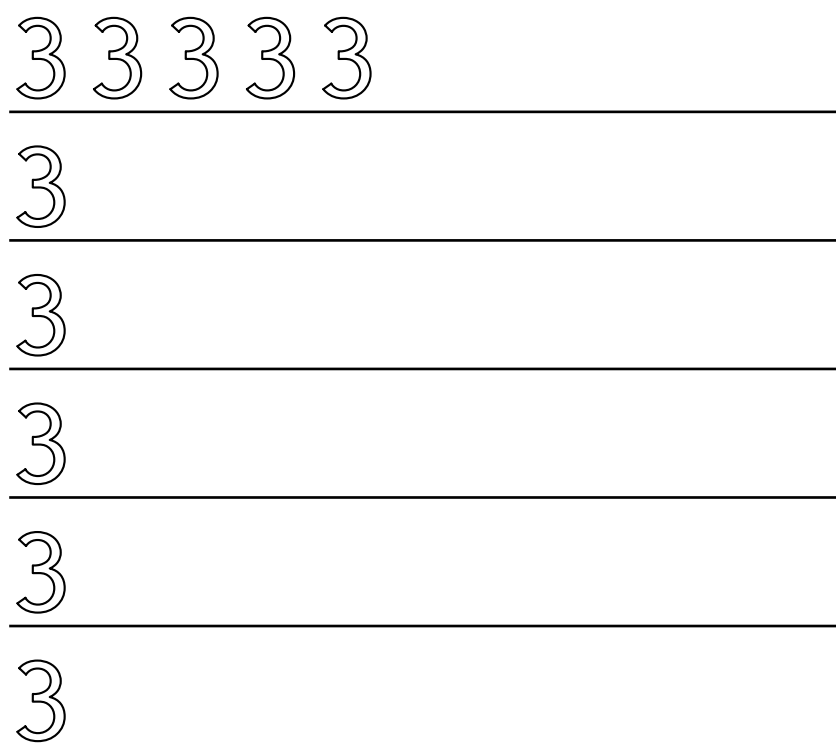

Farv 3 etager på højhuset:

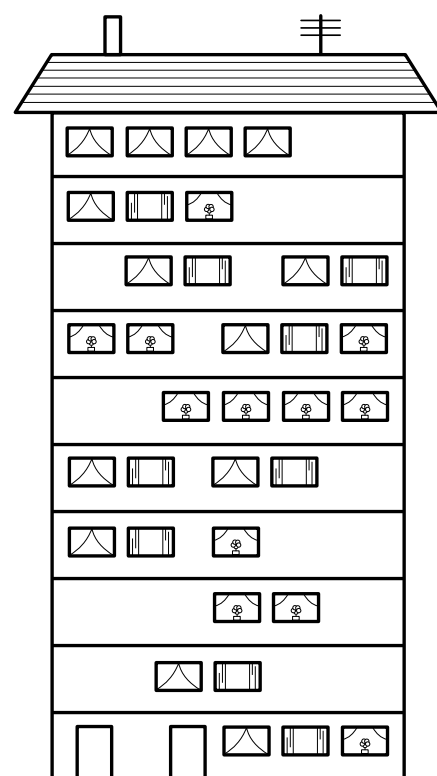

Farv 3 figurer herunder:

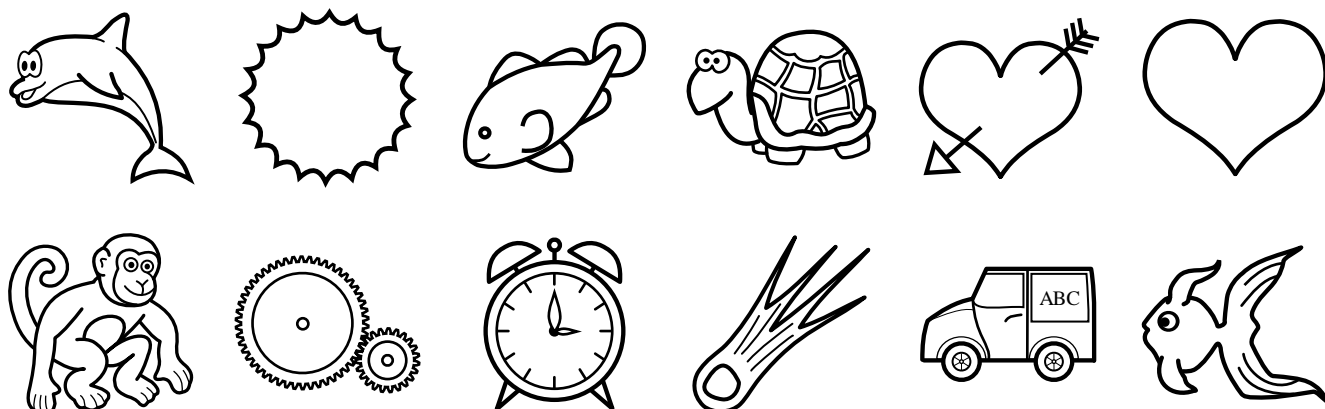

Start i cirklen med nummer 1 - følg derefter pilene:

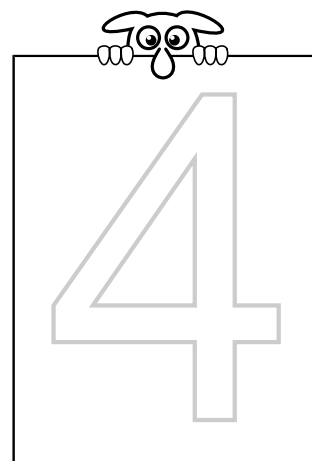
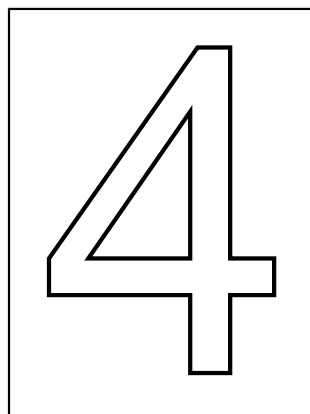
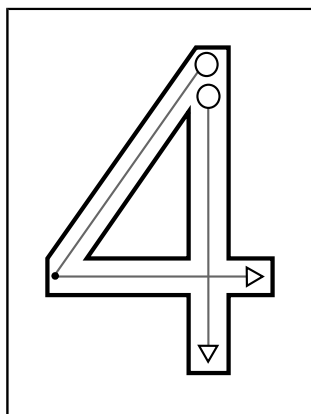
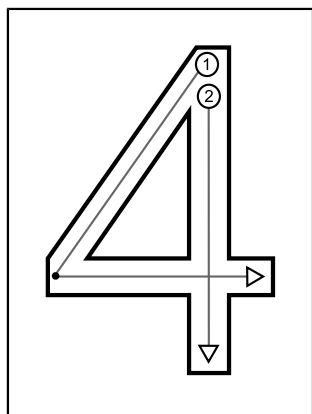

Skriv tallet 4 på disse linier:



Farv 4 etager på højhuset:

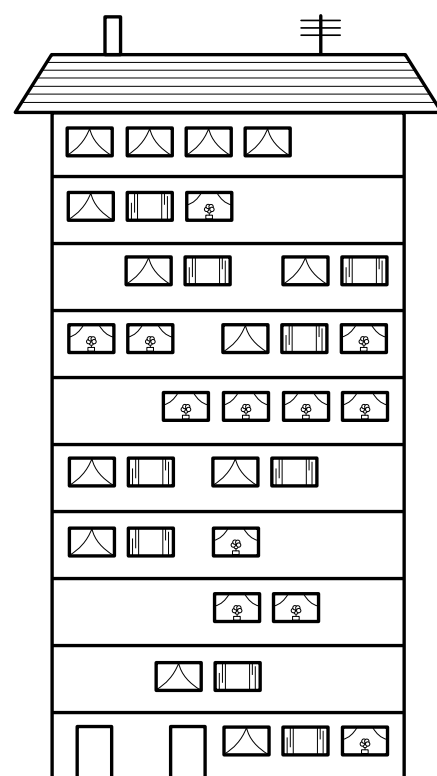

Farv 4 figurer herunder:

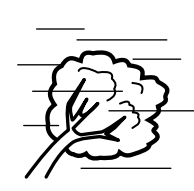
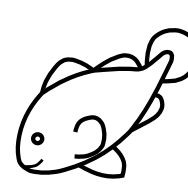
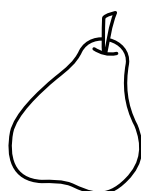
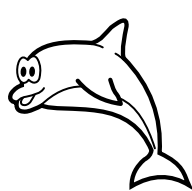
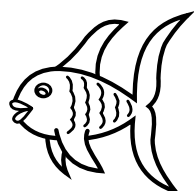
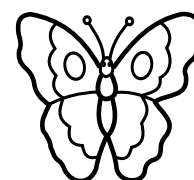
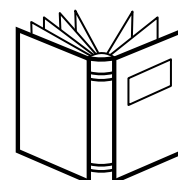
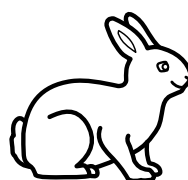
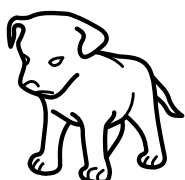

Start i cirklen med nummer 1 - følg derefter pilene:

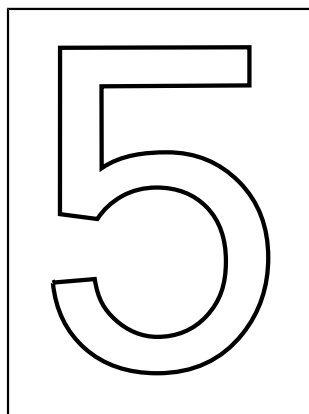
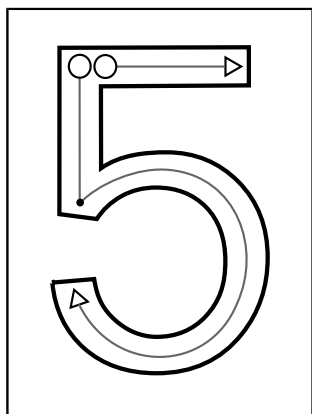
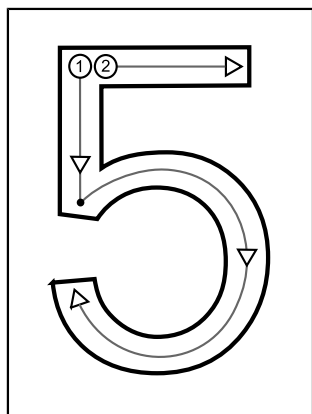

Skriv tallet 5 på disse linier:

5 5 5 5 5

5

5

5

5

5

Farv 5 etager på højhuset:

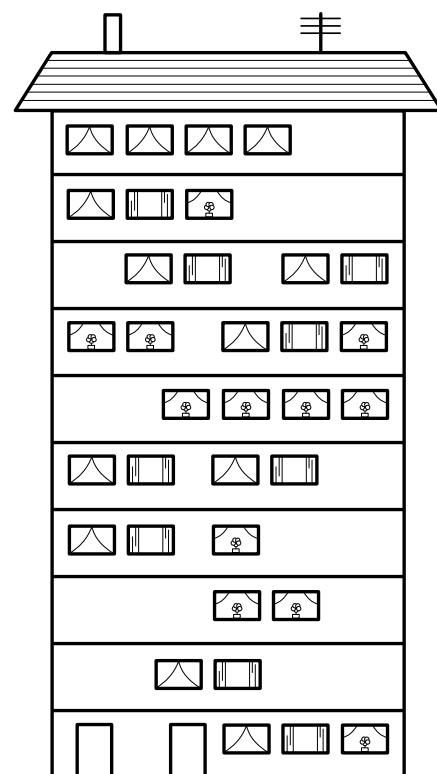

Farv 5 figurer herunder:

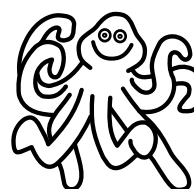
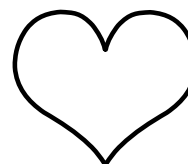
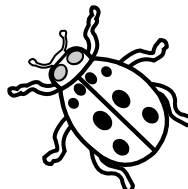
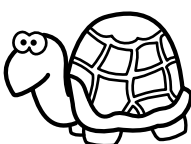
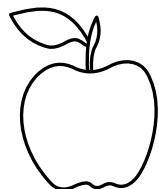
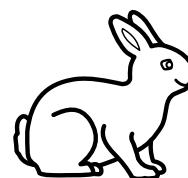
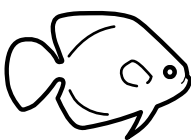
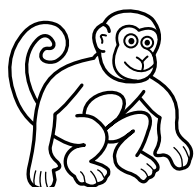

Start i cirklen med nummer 1 - følg derefter pilene:

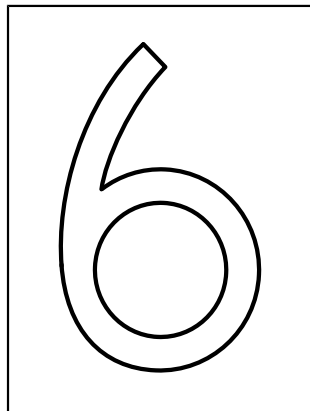
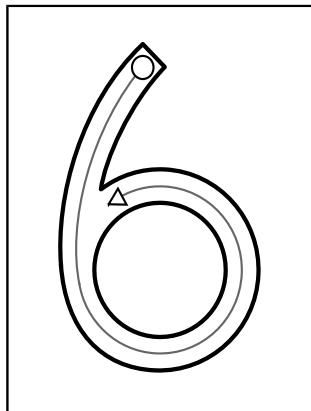
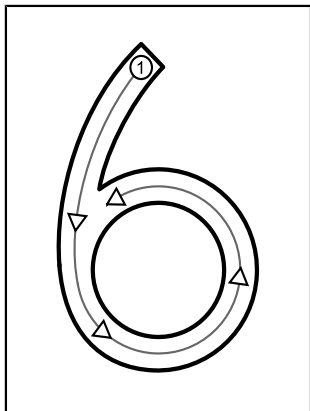

Skriv tallet 6 på disse linier:



Farv 6 etager på højhuset:

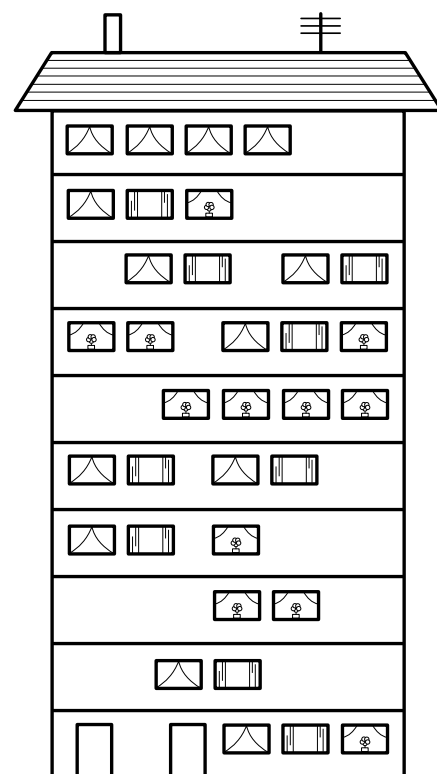

Farv 6 figurer herunder:

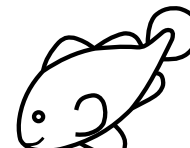
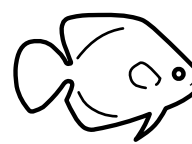
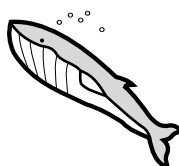
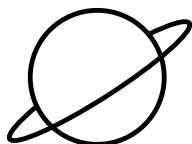
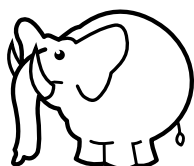
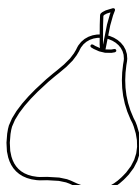
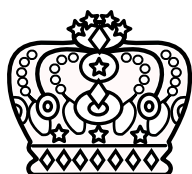

Start i cirklen med nummer 1 - følg derefter pilene:

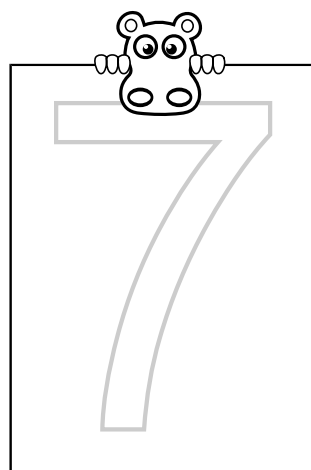
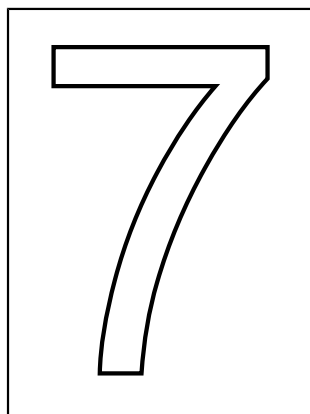
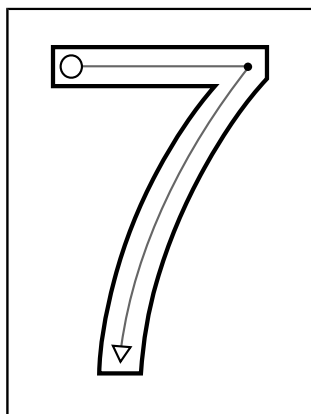
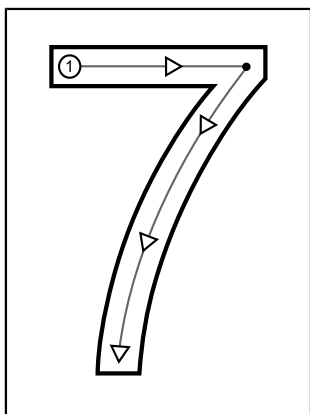

Skriv tallet 7 på disse linier:



Farv 7 etager på højhuset:

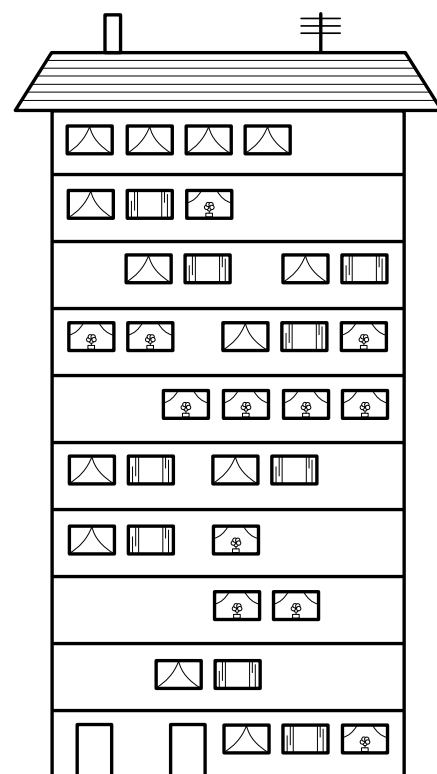

Farv 7 figurer herunder:

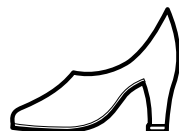
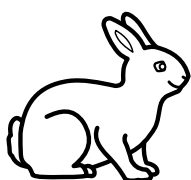
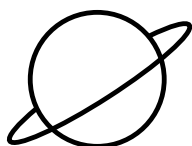
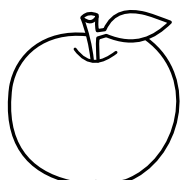
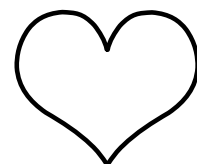
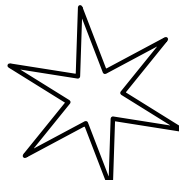
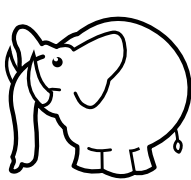
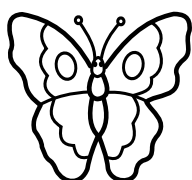



Start i cirklen med nummer 1 - følg derefter pilene:

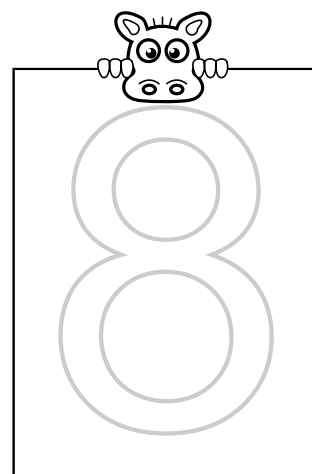
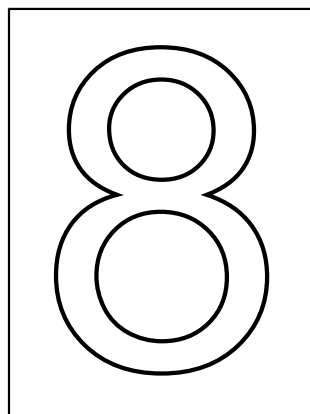
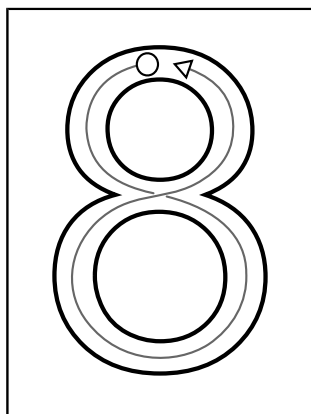
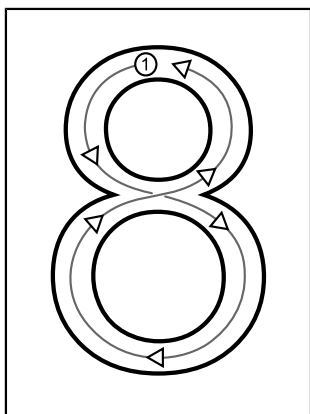

Skriv tallet 8 på disse linier:



Farv 8 etager på højhuset:

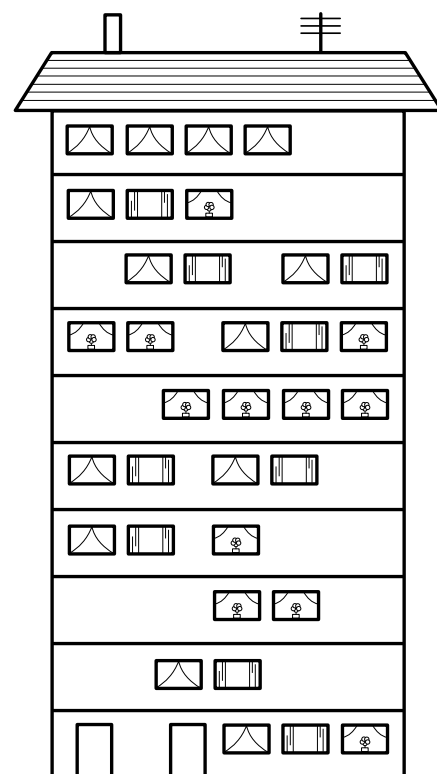

Farv 8 figurer herunder:

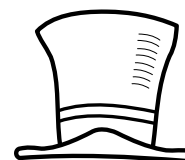
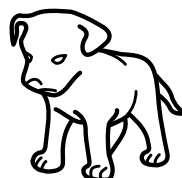
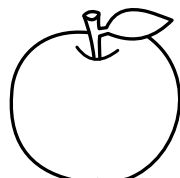
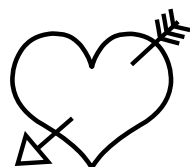
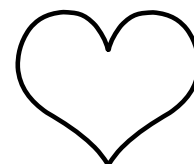
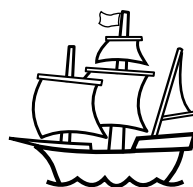
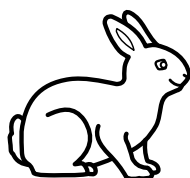
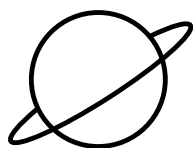

Start i cirklen med nummer 1 - følg derefter pilene:

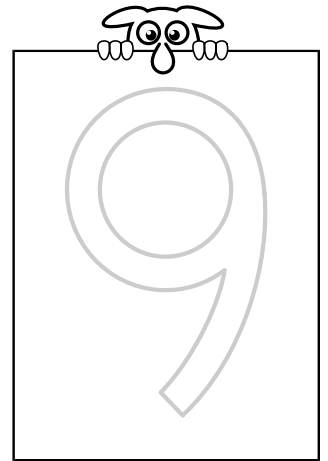
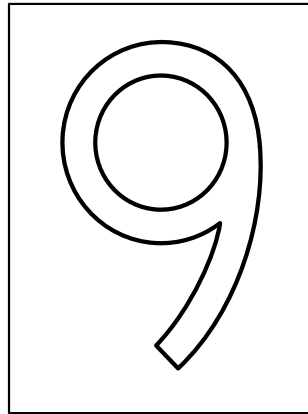
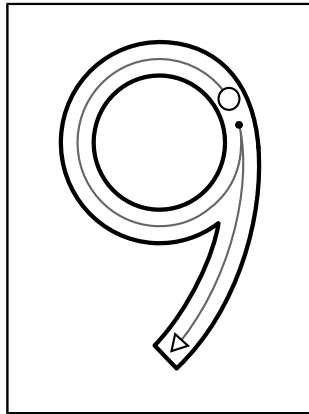
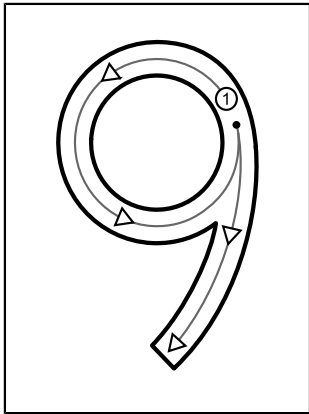

Skriv tallet 9 på disse linier:



Farv 9 etager på højhuset:

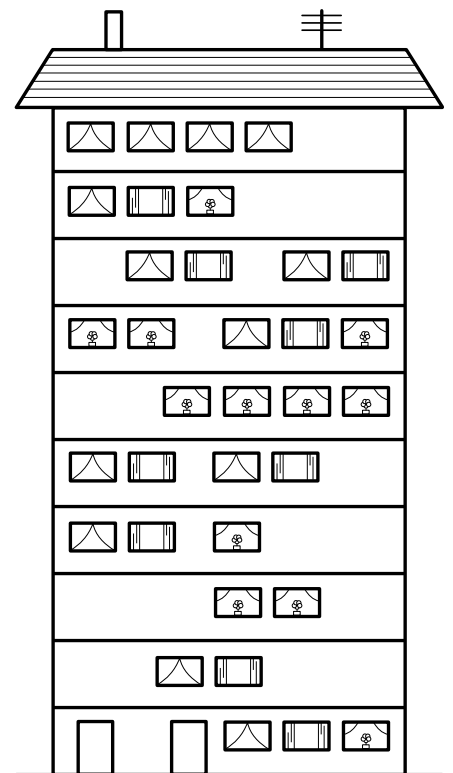

Farv 9 figurer herunder:

