

### FIM 90 S A (Air cooled)

### FIM 90 S W (Water cooled)

- **Structure:** completely realized in stainless steel 18/10 AISI 304. Inside, the structure it includes a bin, realized in atoxic plastic material, where is stored the ice, when this bin is full, the machine stop itself to produce ice. The bin is also insulated, to avoid the melting of the ice stored
- **Feet:** Nr 4 made in plastic material, adjustable in height for levelling
- **Door:** in the front part of the appliance is located the door plastic made that closes the storage bin
- **Water inlet and outlet:** both located in the rear part of the appliance. The water inlet is 3/4" size, while the water outlet is 24 mm Ø. Both the pipes for the water inlet and outlet are included in the machine, the one for the inlet is about 100 cm long, while the outlet is about 50 cm
- **Kind of ice:** flake
- **Production (Kg/24h):** 90
- **Bin capacity (Kg):** 20
- **Cooling unit:** bottom mounted, with the condensing unit compounded by Nr 1 hermetic compressor and Nr 1 finned condenser, air cooled through a fan, in the version "A" or Nr 1 condenser, water cooled, in the version "W". Also, the motor compartment, incorporates the special evaporator with the screw with no end that crush the ice once formed, and automatically release it into the storage bin. All the mounted components are industrial grade to grant the maximum reliability
- **Water consumption (litres/Kg):** 1 (version A), 6,3 (version W)
- **Refrigerant:** R452A CFC-free
- **Voltage (V/ph/Hz):** 220-230/1/50
- **Breakers:** Nr 1 glass cartridge fuse with a rating of 10A, at protection of the appliance
- **Noise level (dB(A)):** ≤ 50
- **Dimensions (W x D x H cm):** 50 x 66 x 82
- **Net weight (Kg):** 60
- **Packed dimensions (W x D x H cm):** 55 x 71 x 88 (0,35 m<sup>3</sup>)
- **Gross weight (Kg):** 70

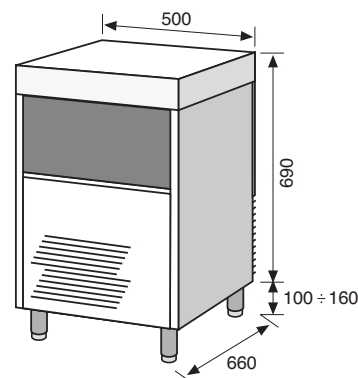

### ACCESSORIES AVAILABLE



Natural refrigerant R290



230V / 60 Hz Different voltage



115V / 60 Hz Different voltage

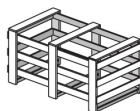

Wooden crate packing



ISO 9001:2015



EN ISO 13485:2016



VERS. 07.21

\* The declared performances are referred at +26°C ("A" version) and +32°C ("W" version) ambient temperatures, relative humidity of 70% and +16°C water temperature.

\* Should it be necessary or useful without undermining any model essential features, technical and stylistic characteristics are subject to be changed without manufacturer's previous notice.

N-Wissen GmbH

info@lab-wissen.de;

Tel: +49 (0) 69 8900 4008;

Fax: +49 (0) 69 8900 4007

Ferdinand-Porsche-Str. 2, 63073 Offenbach - Germany