

LCDF 460 W (White finishing)

- **Structure:** completely in sheet steel white epoxy coated (rust-proof material) outside and embossed aluminium inside
- **Insulation:** high density (40 Kg/m³) foamed-in-place polyurethane, with a thickness of 100 mm. CFC-free
- **Feet:** Nr 4, fix (not adjustable), made in plastic material, granting the maximum stability
- **Lid:** Nr 1 hinged, fully insulated, realized in sheet steel white epoxy coated outside and atoxic plastic material inside. The lid is fitted up with counterbalanced hinges (to avoid unexpected lid closing), external robust, ergonomic handle, perimetric magnetic rubber gasket (granting a perfect seal) and security key locking
- **Control panel:** located in the bottom part of the structure, it includes the digital electronic thermostat with incorporated alarm
 - Digital electronic thermostat with incorporated alarm : microprocessor operating, with 4 switches, allowing the control of all the refrigerator functions (maintaining of the setted temperature, defrostings, compressor and fans functioning). The internal temperature is displayed with a LED display, with red colour, bright indication and an accuracy of 1°C. Into its functions, the thermostat includes even an alarm, both acoustic (with a buzzer) and visual (with indication LED dots) for temperature deviations, both over or below than the programmed one, with limits that remains adjustable according to the user needs. The acoustic alarm can be even muted through a special switch. The thermostat includes also the ON/OFF switch of the freezer
- **Cooling unit:** bottom mounted, with the condensing unit compounded by Nr 1 hermetic compressors and Nr 1 finned condenser, air cooled through a fan. Also, foamed into the insulation of all storage chamber walls, there are the evaporating pipes, in order to grant the maximum temperature stability and uniformity. All the used components are industrial grade granting the maximum reliability
- **Defrosting:** manual, with discharging hole for draining facilities for the derivate water
- **Refrigerant:** R290 CFC- and HCFC-free
- **Refrigeration:** static, with evaporating pipes throughout all the chamber in order to grant maximum temperature stability and uniformity
- **Temperature range:** infinitely adjustable between -20°C and -45°C
- **Voltage (V/ph/Hz):** 220-230/1/50
- **Plug:** Schuko type
- **Noise level (dB(A)):** ≤ 52
- **Gross capacity (litres):** 480
- **Net capacity (litres):** 460
- **Dimensions (W x D x H cm):** 171 x 73 x 87
- **Net weight (Kg):** 120
- **Packed dimensions (W x D x H cm):** 183 x 85 x 112 (1,75 m³)
- **Gross weight (Kg):** 140

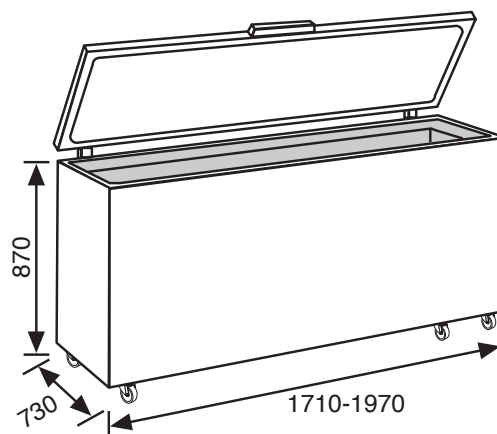

LABORATORY CHEST DEEP FREEZER

ACCESSORIES AVAILABLE



Wire basket



Kit of rollers



Temperature chart recorder



230V / 60 Hz Different voltage



115V / 60 Hz Different voltage

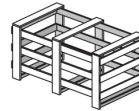

Wooden crate packing



ISO 9001:2015



EN ISO 13485:2016



VERS. 09.21

* The declared performances are referred at +35°C ambient temperature, relative humidity of 70% and without any internal thermal mass (empty cabinet).

* Should it be necessary or useful without undermining any model essential features, technical and stylistic characteristics are subject to be changed without manufacturer's previous notice.

N-Wissen GmbH

info@lab-wissen.de;

Tel: +49 (0) 69 8900 4008;

Fax: +49 (0) 69 8900 4007

Ferdinand-Porsche-Str. 2, 63073 Offenbach - Germany