

### BBR 130 W xPRO (White finishing)

### BBR 130 S xPRO (Stainless steel finishing)

- **Structure:** upright type, realized in sheet steel with special anti-bacterial epoxy coating white colour both in- and outside or in stainless steel 18/10 AISI 304 both in- and outside. All the internal corners are rounded to make easy any cleaning operations and the internal bottom is tray type to contain spills
- **Insulation:** high density (40 Kg/m<sup>3</sup>) foamed-in-place polyurethane, with a thickness of 40 mm. CFC-free
- **Feet:** Nr 4, adjustable in height for levelling
- **Glass door:** Nr. 1, hinged, made a perimetrical aluminium frame and three layers of tempered insulating glass, with vacuum among the glass layers in order to increase the insulating rate. The door is provided with a removable magnetic rubber gasket in order to grant a perfect hermetic closing and reversibility facilities, to change the door hanging. The handle is realized in aluminium, integrated in the door profile, full-height for an higher comfort of use. The door is also fitted with a spring loaded automatic closing device for openings inferior then 90° and special door switch that stops the internal ventilation at the door opening (to limit the air cold loss)
- **Internal equipment:** Nr 3, storage drawers realized in stainless steel 18/10 AISI 304. The drawers are mounted on special ball-bearing anti-tilt telescopic stainless steel slides that allows the drawer complete extraction and they are divided internally in 3 storage columns and fitted with 6 adjustable plastic dividers to keep the bags separated among them. The drawers can easily removed and adjusted in height without the use of any tool
  - **Storage capacity:** Nr 81, 450 ml blood bags
- **Internal lighting:** Nr 1 LED tube, mounted in the side wall, with activation through a special switch located on the control panel. It grants energy saving and prevent the internal heating produced by the traditional neon tubes
- **Control panel "xPRO":** located in the top part of the structure (above the door), microprocessor operating, with capacitive touch-buttons and colour display. The controller supervises all the appliance functions through the EEN (EVERmed Easy Navigation) interface, with icons and written messages, allowing a very intuitive interactivity between the appliance and the user, for an easy setting of all appliance functionalities according to needs and the control of the workings status. The control panel is battery operating in order to grant the functioning of the display and alarms even in case of power failure. The main functions panel are :
  - High resolution 3,5" TFT colour display, LED backlit, showing the appliance working status (actual temperature, compressor functioning, defrosting, alarm running, etc.) and allowing the surfing through the various controller menu for setting and checking purposes
  - Digital temperature displaying and adjusting with an accuracy of 0,1°C
  - Keyboard touch-buttons with automatic block safety protection, to avoid tampering from unauthorized persons
  - Dual-level safety access, with PIN code protections, on both ON/OFF switch and keyboard touch-buttons. Re-programmable PIN codes for increased security from access to the unauthorized personnel
  - Back-up battery, with automatic recharging, granting till 48 hours autonomy for the control panel functioning in case of power failure. The charging status is continuously shown on the display for immediate checking
  - Visual and acoustic alarm signalling (with automatic resetting) for:
    - high and low temperature, with limits programmable from the user through a dedicated menu
    - door ajar, delayed of 2 minutes to allow the standard operations. Programmable alarm delay through a dedicated menu
    - power failure

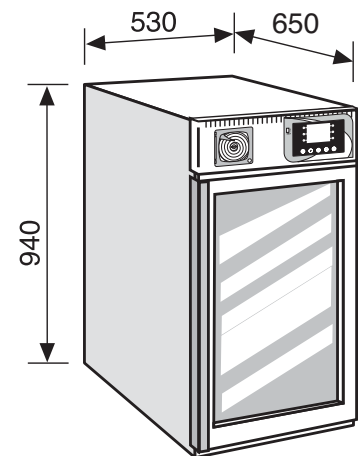









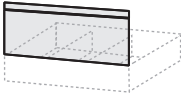

# BLOOD BANK REFRIGERATOR

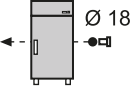
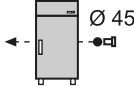
- battery discharged
- condenser dirty
- anti-freezing evaporator
- sensors failure
- Muting facilities for the acoustic alarms, with continuous warning indication on the display and automatic ring-back if the alarm situation persists. Programmable ring-back delay through a dedicated menu
- Test facilities for both control panel functioning, battery charging status and alarm limits
- Alarms log history for the latest 30 alarm conditions (not deletable), with the possibility of verify on the display, the alarm condition and all the related informations (starting time, ending time, highest/lowest peak of temperature reached where applicable)
- Door openings history for the latest 30 days (not deletable), with the possibility of verify on the display, the number of door openings, how many giving alarms and the total time that the door is kept open day-by-day
- Defrosts history for the latest 30 days (not deletable), with the possibility of verify on the type of defrost, starting time and the duration
- Internal ventilation setting facilities, in order to optimize the air-circulation according to the appliance using conditions and needs
- Real-time temperature chart, with surfing possibilities of the previous 52 hours of operations and zooming facilities for a better control of a period of interest
- Written indications on the display selectable from 3 languages (Italian, English and French)
- Pt1000 sensors for a better accuracy of the temperature control
- NO contact to remote the alarm signals
- Software upgrading facilities
- **Temperature chart recorder:** the temperature chart recorder traces on circular paper-charts (125 mm Ø) the temperature of the refrigerator with the range -10°C / +40°C, with weekly recording. The temperature chart recorder is provided with a transparent perspex cover allowing immediate control of the chart, which is fitted with key locking to avoid tampering. It works with a 1,5V battery (AA size) in order to record even during power failure periods. Supplied with the recorder, 100 paper-charts (suitable for almost 2 years recordings) and 1 ink tip
- **Cooling unit:** top mounted, with the condensing unit compounded by Nr 1 hermetic compressors and Nr 1 finned condenser, air cooled through a fan. Also, in the ceiling of the storage chamber, is mounted the finned evaporator with copper pipes, that is housed into a stainless steel cover that incorporate the fan. All the mounted components are industrial grade to grant the maximum reliability
- **Refrigerant:** R134a CFC-free
- **Refrigeration:** forced-air, through a fan, granting the maximum temperature uniformity and stability inside of the cabinet
- **Defrosting:** completely automatic, thermostat controlled. The condensate water is automatically channelled into an heated tray, located in the motor compartment, for the automatic evaporation of the condensate water
- **Temperature range:** infinitely adjustable between +2°C / +15°C
- **Voltage (V/ph/Hz):** 220-230/1/50
- **Plug:** Schuko type (type F+E)
- **Breakers:** Nr 2 glass cartridge fuses with a rating of 10A, at protection of the appliance
- **Noise level (dB(A)):** ≤ 48
- **Gross capacity (litres):** 150
- **Net capacity (litres):** 130
- **Dimensions (W x D x H cm):** 53 x 65 x 94
- **Net weight (Kg):** 80
- **Packed dimensions (W x D x H cm):** 65 x 72 x 114 (0,54 m<sup>3</sup>)
- **Gross weight (Kg):** 90

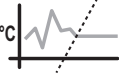
# BLOOD BANK REFRIGERATOR

## ACCESSORIES AVAILABLE

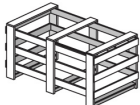
	Plastic partitions for drawers		Front top for drawers
	Kit of rollers		Safety door lock with key
	Data logger function with USB port		Ballasted sensor for simulation of product temperature alarm
	Cable port with cover Ø 18 mm		Cable port with cover Ø 45 mm
	Deduction for solid door (instead of glass door)		Safety anti-freezing thermostat
	Temperature uniformity and stability kit		Natural refrigerant R290
	GSM/GPRS telephone dialer		230V / 60 Hz Different voltage
	115V / 60 Hz Different voltage		Wooden crate packing



ISO 9001:2015



EN ISO 13485:2016



0051



VERS. 04.20

Product certified as medical device in class IIa  
Certificate N. 1448/MDD

\* The declared performances are referred at +35°C ambient temperature, relative humidity of 70% and without any internal thermal mass (empty cabinet).

\* Should it be necessary or useful without undermining any model essential features, technical and stylistic characteristics are subject to be changed without manufacturer's previous notice.

N-Wissen GmbH  
 info@lab-wissen.de;  
 Tel: +49 (0) 69 8900 4008;  
 Fax: +49 (0) 69 8900 4007  
 Ferdinand-Porsche-Str. 2, 63073 Offenbach – Germany