



COMPRESSED AIR TOOLS

HIGH QUALITY TOOLS FOR PROFESSIONALS | MADE IN DENMARK



PROFESSIONAL PRODUCTS FOR COMPRESSED AIR

In this catalogue you will find the assortment of tools for compressed air.

JWL also produces Air Boy® blow guns, quick connect couplings and accessories for compressed air like hoses, fittings etc.

Contact us to get the catalogue or download from www.jwl.dk.



Tools for compressed air



INFLATING GUNS

With e.g. QT Connector or clamping nipple. Nipples are also sold separately.

4



JET FLUSHER

Effective cleaning of cooling systems without use of solvents or chemicals.

6



JET WASHER

Combines water and compressed air for effective cleaning without damage.

8



SODA BLASTER

For gentle removal of paint, varnish or surface dirt. With container or as a set for larger surfaces.

10



SANDBLASTER

Handy and powerful tools for removing rust and ingrained dirt. As a set or with container.

12



CLEANING GUNS

Various cleaning guns for efficient cleaning with cleaning agents. Multi Cleaner for AC cleaning.

14



BRAKE BLEEDERS

For quick bleeding and refilling of brake systems for all types of vehicles incl. MC.

16



UNDERSEAL GUNS

Various guns for both water- and oil based liquids. With container or for disposable canisters.

18

GET ALL THE TOOLS AS PRIVATE LABEL

If you like to have your own private label tools for compressed air, then you can get all the products in this catalogue as private label. You can have your own logo cast in the handle and it is possible to have your own text engraved on the side of the handle as well.

Contact us to get more information. Call +45 75 89 16 99 or send an e-mail to salg@jwl.dk.

You can also visit www.jwl.dk.

The patented QT Connector secures airtight connection to tire valves. Easy to use as a quick connect coupling. Sold separately or with JWL Inflating Gun.



150118



Technical description

Connection	1/4" internal thread
Working pressure	Max. 12 bar (174 psi)
Gauge	0-12 bar (0-174 psi)
Precision 0-12 bar	+/-0.19 bar
Measurement	bar og psi

Inflating Guns

JWL Inflating Guns are used to inflate all types of auto tires. The functional and reliable inflating guns have infinite adjustment of the air volume. Moreover, air pressure is used to facilitate the activation of the handle. All JWL Inflating Guns are supplied with an air-escape valve on the side. Choose between inflating gun with QT Connector, twin-connector or clamping nipple.

The hose is available in different lengths, which gives the possibility of more mobility.

The inflating guns are mounted with a quality gauge (0-12 bar). It is in accuracy class 1.6 in accordance with EN 837-1 standard. All inflating guns are precision tested during production where the gauges have an accuracy of 0-12 bar: ± 0.19 bar.

Inflating nipples are also sold separately. The inflating nipples are connected directly to a compressed air coupling or hose.

CAUTION: Always remember to check the tire pressure.



116021



116002

◀ The QT Connector can be delivered separately and comes for hose connection or threaded.

▶ The QT Connector is easy to use. Just push the connector on to the valve. The QT Connector is completely airtight when connected. Pull back to release it from the valve.



JWL Inflating Gun with QT Connector

Art.No.

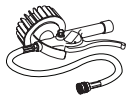

Inflating Gun, $\varnothing 63$ mm pressure gauge, QT Connector, 0.5 m hose

151120-134

Inflating Gun, $\varnothing 63$ mm pressure gauge, QT Connector, 1.0 m hose

Inflating Gun, $\varnothing 63$ mm pressure gauge, QT Connector, 1.5 m hose

Inflating Gun, $\varnothing 80$ mm pressure gauge, QT Connector, 0.5 m hose

Inflating Gun, $\varnothing 80$ mm pressure gauge, QT Connector, 1.0 m hose

151134-134

Inflating Gun, $\varnothing 80$ mm pressure gauge, QT Connector, 1.5 m hose

JWL Inflating Gun with clamping nipple

Art.No.



Inflating Gun, $\varnothing 63$ mm pressure gauge, clamping nipple, 0.5 m hose

150120-134

Inflating Gun, $\varnothing 63$ mm pressure gauge, clamping nipple, 1.0 m hose

150126-134

Inflating Gun, $\varnothing 63$ mm pressure gauge, clamping nipple, 1.5 m hose

150122-134

Inflating Gun, $\varnothing 80$ mm pressure gauge, clamping nipple, 0.5 m hose

150130-134

Inflating Gun, $\varnothing 80$ mm pressure gauge, clamping nipple, 1.0 m hose

150134-134

Inflating Gun, $\varnothing 80$ mm pressure gauge, clamping nipple, 1.5 m hose

150138-134

JWL Inflating Gun with twin connector

Art.No.



Inflating Gun, $\varnothing 63$ mm pressure gauge, twin connector, 0.5 m hose

150123-134

Inflating Gun, $\varnothing 80$ mm pressure gauge, twin connector, 0.5 m hose

150131-134

Inflation nipples

Art. No.

Art. No.

QT Connector 3/16" ($\varnothing 5.5$ mm) hose connection

116021

Coupler plug 1/4" hose connection, bicycle

150113

QT Connector 1/4" ($\varnothing 6.5$ mm) hose connection

116022

Coupler plug JWL 521 "Fr/N", car

150114

QT Connector internal thread 1/4" BSP

116002

Coupler plug JWL 521 "Fr/N", bicycle

150115

QT Connector internal thread 1/4" NPT

116032

Coupler plug JWL 522 "ORION", car

150116

Coupler plug JWL 520 "Euro", car

150110

Coupler plug JWL 522 "ORION", bicycle

150117

Coupler plug JWL 520 "Euro", bicycle

150111

Bicycle plug for mounting in clamping nipple

150118

Coupler plug 1/4" hose connection, car

150112

Jet Flusher effectively cleans cooling systems without the use of solvent, but with only clean water and air.



Materials

Handle and trigger	Acetal plastic
Valve	Acetal plastic
Gaskets/O-rings	Nitrile
Springs	Hardened spring wire
Nozzles	POM

Technical description

Air connection	1/4" int. thread (BSP)
Water connection	1/2" nipple / 3/4" GHT thread
Working pressure	6-10 bar (87-145 psi)
Air consumption	Min. 200 l/min.

Jet Flusher

Ensure optimum cooling system operation with JWL Jet Flusher. Quick and efficient.

Engine coolant degrades over time and most likely contaminates with abrasive particles and foreign materials. Prevent this from happening by flushing the cooling system occasionally and when replacing cooling system parts.

JWL Jet Flusher works without the use of solvents or harsh chemicals, but combines water with compressed air to increase the efficiency of the cooling system flushing. The compressed air increases the water pressure compared to the main water supply. JWL Jet Flusher is equipped with variable control valves for both air and water flow. This allows the water supply to be shut off directly at the Jet Flusher when having a break or at nozzle changes.

The JWL Jet Flusher comes as standard with a stepped multi-nozzle that can easily be changed to the washer nozzle using the built-in bayonet connection. The water is connected either with the supplied nipple (1/2" / ø13 mm) suitable for regular water connectors or the built-in 3/4" GHT water hose thread. The JWL Jet Flusher is designed with a built-in swivel that allows the connected water hose to freely rotate around the Jet Flusher.

The materials used for the JWL Jet Flusher are impact resistant.

CAUTION: Extreme care should be taken when flushing cooling systems in poor condition.

Instructions

Insert the stepped flusher nozzle into the hose suited for the flush job and flush as much as needed until the radiator (1) / engine block (2) / heater core (3) outflow is clear. With water flowing through the system, give short intermittent blasts of air to increase the efficiency. To prevent damage, make sure there is free passage through the cooling system before flushing.

- | | |
|------------------------------|-------------------------------|
| 1 Radiator | D Expansion tank |
| 2 Engine block | E Upper radiator hose |
| 3 Heater core | F Thermostat |
| A Radiator cap | G Heater control valve |
| B Drain valve | H Inlet heater hose |
| C Lower radiator hose | |

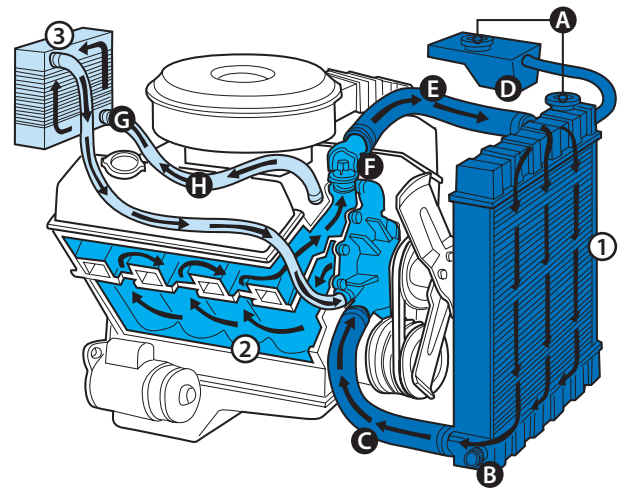

JWL Jet Flusher

Art. No.

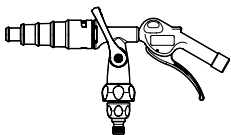

Jet Flusher with 1/2" nipple or 3/4" GHT thread for water connection. Accessory adapter included.

102185-000

Accessories

Art. No.



Flusher nozzle

102050



Washer nozzle

102030



Accessory adapter for JWL Jet Flusher and Jet Washer

102040

Use Jet Washer for effective and gentle cleaning without cleaning detergents.



Materials

Handle and trigger	Acetal plastic
Valve	Acetal plastic
Gaskets/O-rings	Nitrile
Springs	Hardened spring wire
Nozzles	POM

Technical description

Air connection	1/4" int. thread (BSP)
Water connection	1/2" nipple / 3/4" GHT thread
Working pressure	6-10 bar (87-145 psi)
Air consumption	Min. 200 l/min.



Jet Washer

With JWL Jet Washer you can effectively clean and wash without damaging the surface with high pressure. The Jet Washer is more powerful than a common water supply. It combines compressed air and water, which gives the ideal conditions for washing, degreasing and shampooing. Jet Washer is designed to allow operators to come close to the items being washed, without getting wet. There is no splash back.



Jet Washer is supplied with infinite adjustments for both air and water flow. This makes it possible to turn off the water directly on the washing gun, when it is not being used.

Jet Washer comes as standard with a wide washing nozzle, which can easily be changed for other nozzles e.g the flusher nozzle for cooling system flushing. The water can be connected either by using the supplied nipple (1/2" / ø13 mm) that fits most common water couplings or by using the built-in 3/4" GHT water hose thread.

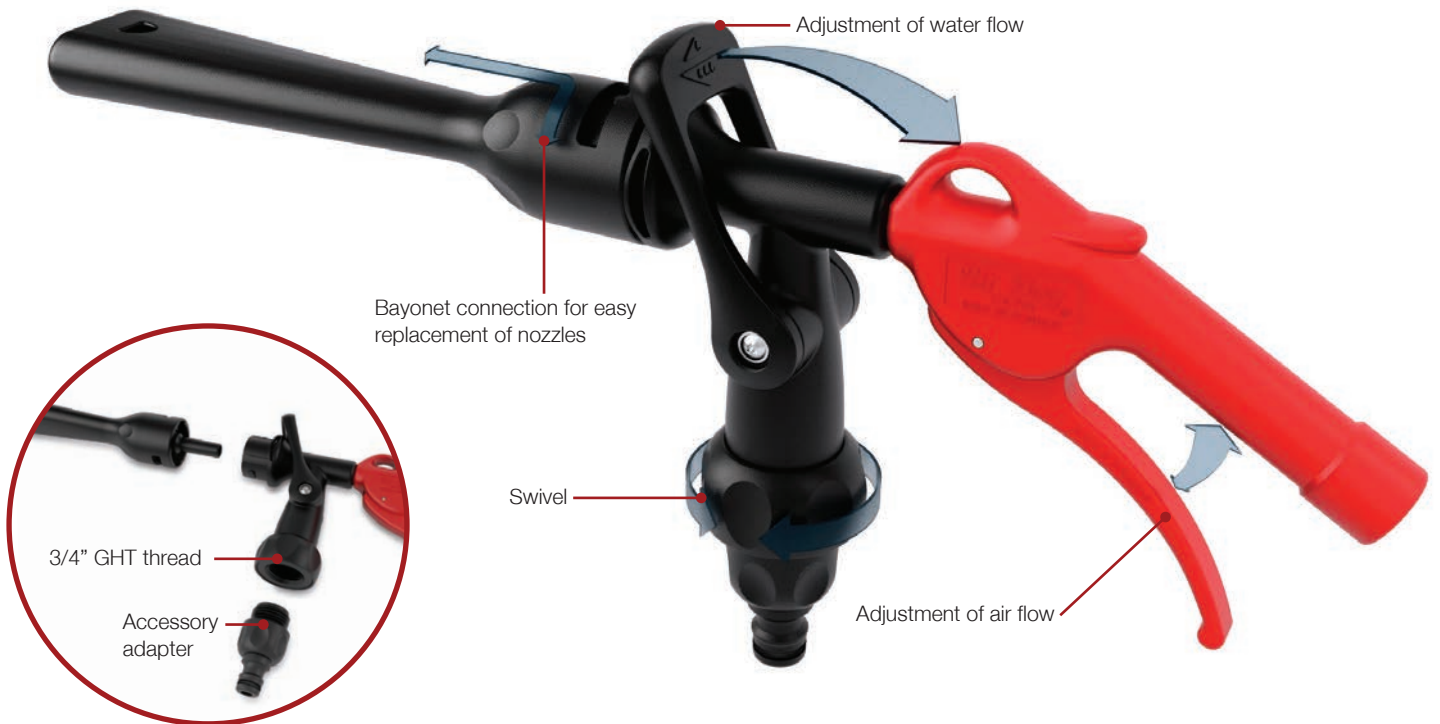
The JWL Jet Washer is designed with a built-in swivel that allows the connected water hose to freely rotate around the washing gun.

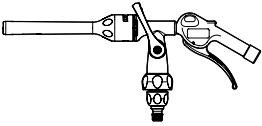

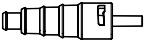
JWL Jet Washer		Art. No.
	Jet Washer with 1/2" nipple or 3/4" GHT thread for water connection. Accessory adapter included.	102010-000

Accessories		Art. No.
	Flusher nozzle	102050
	Washer nozzle	102030
	Accessory adapter for JWL Jet Flusher and Jet Washer	102040

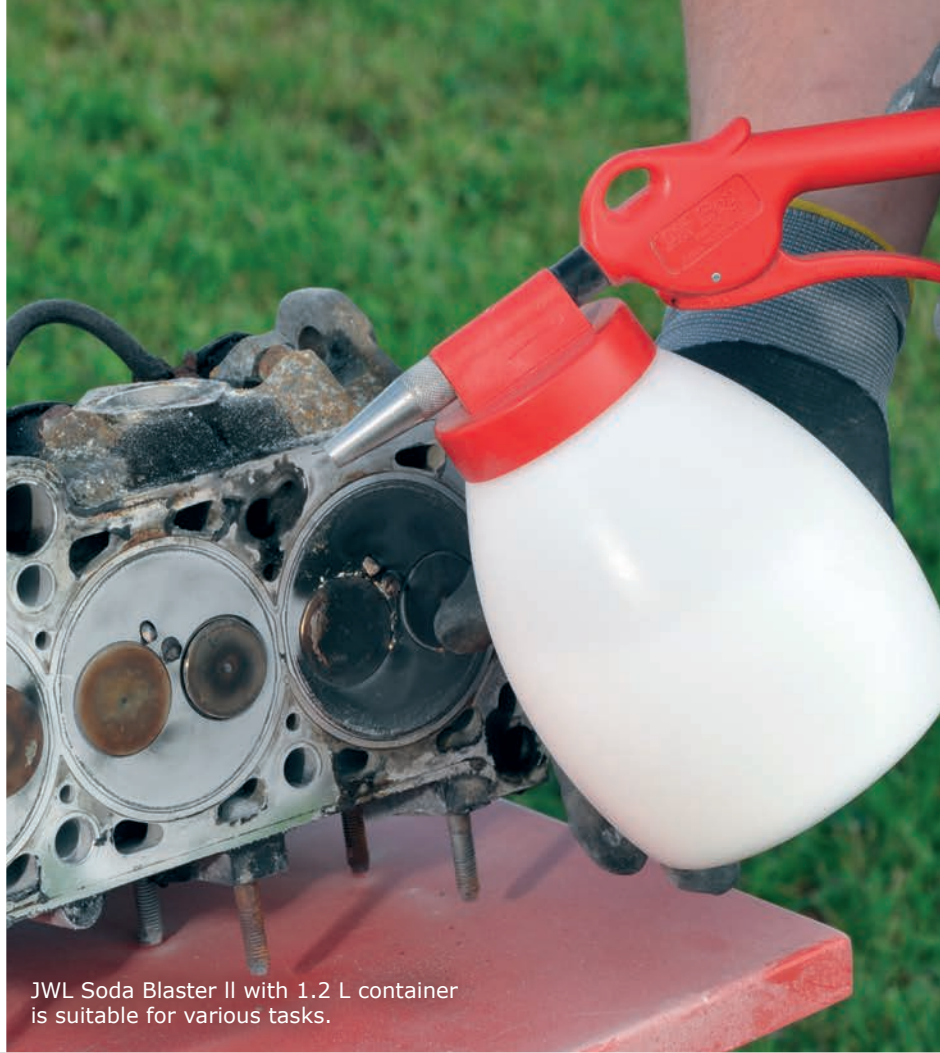

JWL Soda Blaster II with 1.2 L container is suitable for various tasks.



The powerful JWL Soda Blaster set is useful for larger surfaces.



Materials

Handle and trigger	Acetal plastic
Valve	Acetal plastic
Gaskets/O-rings	Nitrile
Springs	Hardened spring wire
Container	PEHD
Precision nozzle 145950-000	Hard. steel, electro-galv.
Wide nozzle 145955-000	POM

Technical description

Working pressure	6-12 bar (87 -174 psi)
Air consumption 145154-000	Min. 180 l/min. at 8 bar
Air consumption 145110-000	Min. 450 l/min. at 8 bar
Container	1.2 L
Thread	1/4" internal thread BSP/NPT



Soda Blaster

Soda blasting is a fast and gentle method of removing paint, varnish and surface rust – even from hard to reach places.

JWL Soda Blaster II is an enhancement of our successful soda blasting gun. The nozzle is set for the optimal output, and can be replaced with a new precision nozzle or a high performance wide nozzle.

The JWL Soda Blaster II is equipped with a practical, refillable container of 1.2 L.

JWL Soda Blasting Set is an effective and powerful soda blaster for the larger tasks. The Soda Blasting Set enables you to adjust the airflow and soda flow independently.

JWL Soda Blasters are suitable for hobby as well as professional use. To get the wanted result, always use soda specifically intended for blasting.

Soda blasting benefits

- neither warms up nor stretches the sheet metal
- does not damage glass, rubber or plastic which means minimal need for shielding
- protects the bare metal from rusting away in contrast to sandblasting
- removes anti-fouling paint from boats without damaging the hull
- removes varnish and does not damage seals (rubber or plastic)
- removes paint from glass surfaces or window frames without damaging the glass or rubber seals
- removes varnish from wooden furniture
- is gentle and environmentally friendly



Always use P2 respiratory protection, hearing protection, gloves and eye- and facemask when blasting with soda. Blasting soda is pure NaHCO_3 (baking soda). It is not dangerous, but may be harmful if inhaled as dust.

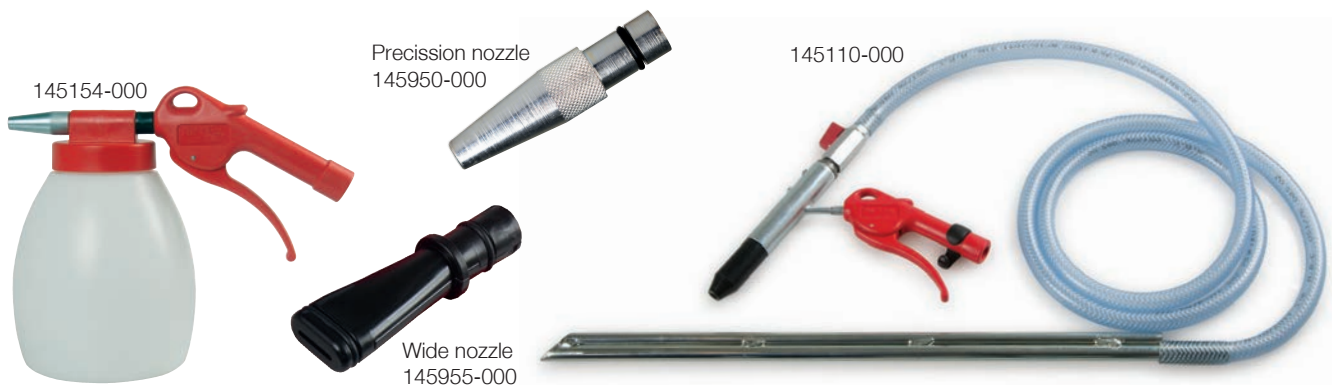

JWL Soda Blasters

Art. No.



JWL Soda Blaster II with a precision nozzle and 1.2 L container. A high-performance wide-nozzle is available as additional fitting. Requires a compressor with a capacity of at least 2.5 HP / 180 l/min.

145154-000

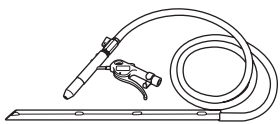

JWL Soda Blasting Set. Suitable for larger surfaces. Enables separate adjustment of air and soda volume. Requires a compressor with a capacity of at least 5.5 HP / 450 l/min.

145110-000

Accessories

Art. No.

Soda (NaHCO_3) specifically intended for blasting 1 kg	320102-000
Soda (NaHCO_3) specifically intended for blasting 5 L	320103-000
Soda (NaHCO_3) specifically intended for blasting 25 kg	320101-000
Precision nozzle JWL Soda Blaster II (145154-000) in hard. steel, electric galvanized.	145950-000
Wide nozzle to JWL Soda Blaster II (145154-000) in POM. 3 pcs.	145955-000
Steel nozzle with o-ring for Sodablasting Set (145110-000)	145803
Container 1.2 L	143300

The powerful JWL Sandblaster set is useful for larger surfaces or for use in sandblasting cabins.

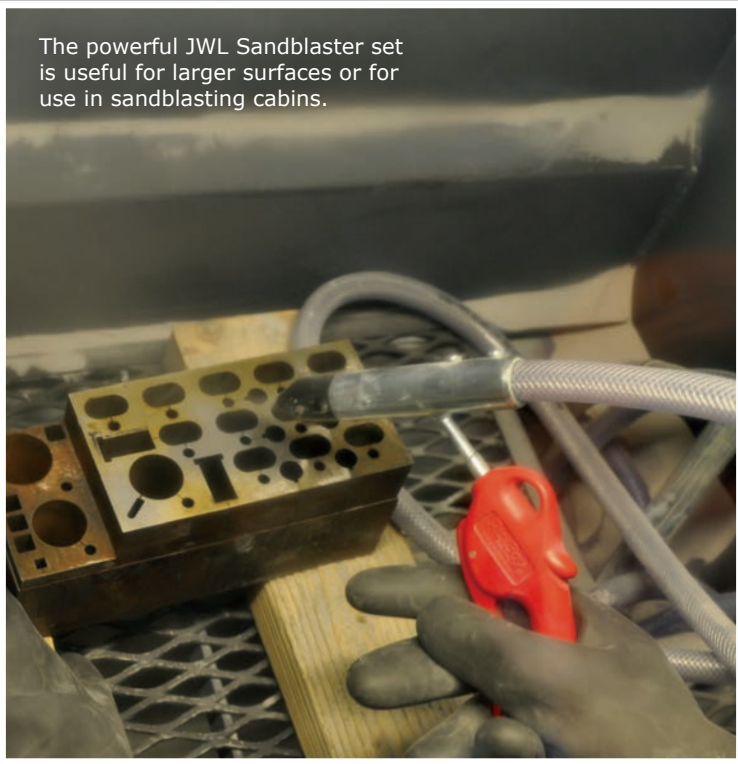

JWL Sandblaster with 1.2 L container is suitable for various smaller tasks.



Materials

Handle and trigger	Acetal plastic
Valve	Acetal plastic
Gaskets/O-rings	Nitrile
Springs	Hardened spring wire
Container	PEHD
Nozzle	Hard. steel, electro-galv.

Technical description

Working pressure	6-12 bar (87 -174 psi)
Air consumption (145100-000)	Min. 180 l/min. at 8 bar
Air consumption (145102-000)	Min. 450 l/min. at 8 bar
Container	1.2 L
Thread	1/4" int. thread BSP/NPT



Sandblaster

JWL Sandblasters are handy, powerful tools for efficiently removing rust and ingrained dirt from various surfaces.

JWL Sandblasters are ergonomically designed and therefore very user-friendly. They are lightweight and easily operated. Sand quantity/suction force is infinite adjustable and easily regulated with the trigger.

The JWL Sandblasting Gun with a practical 1.2 L refillable container efficiently removes rust and ingrained dirt from various surfaces.

JWL Sandblasting Set is for larger tasks and surfaces or for use in sandblasting cabins.

Recommended sand

For standard tasks:

Sand grade 00 with grain size 0.3 – 0.6 mm should be used.

For rough tasks:

Sand grade 0 with grain size 0.4 – 0.8 mm is ideal.



Always use P2 respiratory protection, hearing protection, gloves and eye- and facemask when blasting with sand.



145100-000

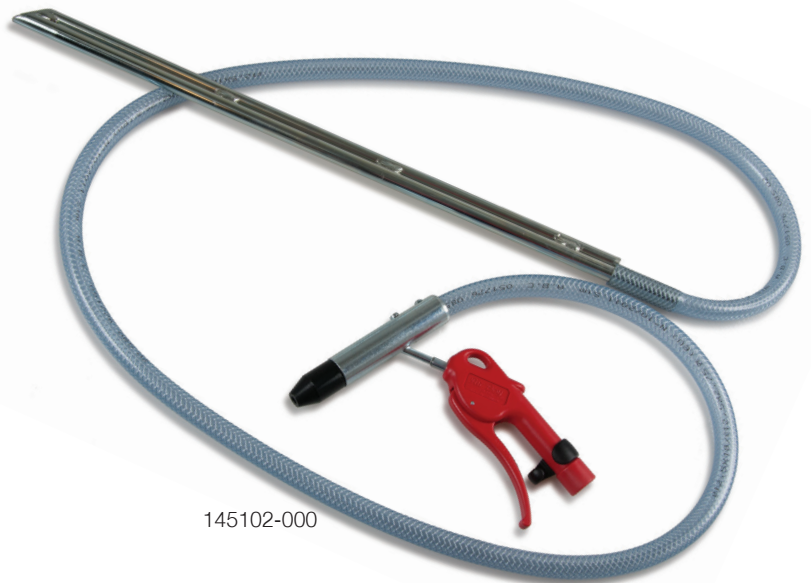

145102-000

JWL Sandblaster

Art. No.



JWL Sandblasting gun with 1.2 L container.

145100-000

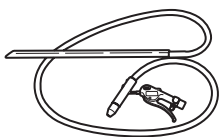

JWL Sandblasting set.

145102-000

Accessories

Art. No.

Nozzle for Sandblasting Gun 145100

145805

Steel nozzle with o-ring for Sandblasting Set (145102)

145803

Container 1.2 L

143300

Container with lid 1.2 L

143160



Instructions: AC cleaning with JWL Multi Cleaner

1. Preparation and treatment of evaporator: Dry the evaporator for 10 minutes under following conditions: A/C: off. Air Inlet: circulation. Temp.: warm. Air outlet: foot. Fan: high
2. Put a tray under the evaporator's drain hose and place a mat under the cooling unit to avoid dripping on the floor. Open windows for ventilation.
3. The ignition of the vehicle should be disconnected or turned off before handling the evaporator.
4. When cleaning, the vehicle should be prepared as specified in the manufacturer's operating instructions.
5. Insert the spray nozzle into the filter inlet or resistor opening (or another suitable inlet) and spray whole container into the evaporator while moving the nozzle around to cover the whole evaporator surface.
6. Once it has been sprayed on, the cleaning fluid should be allowed to act for about 15-20 minutes.
7. Reinstall filter and other temporarily removed parts.
8. To dry the treated evaporator proceed as follows: A/C: off. Air inlet: circulation. Temp.: warm. Air outlet: foot. Fan: high. Time to dry: 20 – 30 minutes.

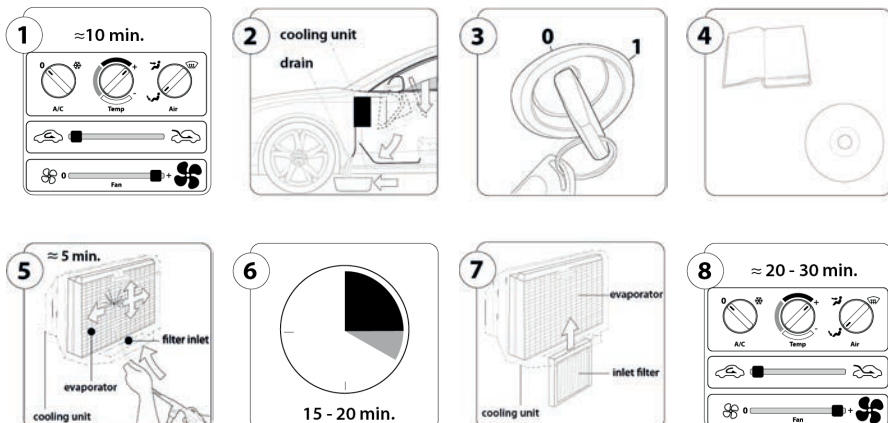



Cleaning Guns

JWL Cleaning Guns are powerful, efficient cleaning guns suitable for most kinds of cleaning agents. JWL Cleaning Guns are ideal for degreasing, cleaning and detergent coating purposes, even where aggressive chemicals are used.

JWL Cleaning Guns are designed to assist you in the best possible way on a daily basis. Therefore, JWL Cleaning Guns are user-friendly and easy to operate. The liquid flow is infinite

adjustable and easily regulated using the trigger. We use the compressed air to ease the activation of the handle making it easy, accurate and simple to operate.

JWL Cleaning Guns are available in several models with various nozzle types, container sizes and suction hoses. All materials are impact and corrosion resistant.



142131-000



142130-000



142100-000



142178-000

Technical description

Working pressure	6-12 bar
Temperature range	-10°C to +80°C
Air consumption	180 l/min. at 8 bar
Container	1.2 L
Thread	BSP/NPT

Materials

Handle and trigger	Acetal plastic
Valve	Acetal plastic
Gaskets/O-rings	Nitrile
Springs	Hardened spring wire
Container	PE
Suction pipe	Nylon PA11
Hose	PVC
Nozzles	POM, PA6, steel, brass

JWL cleaning guns

Art. No.

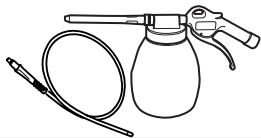

Multi Cleaner with 1.2 L container. Extension probe included. Also ideal for AC cleaning.

142178-000

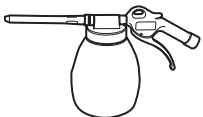

JWL Cleaning Gun with 1.2 L container, 150 mm plastic nozzle.

142130-000

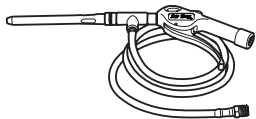

JWL Cleaning Gun, with 150 mm plastic nozzle and suction hose.

142131-000

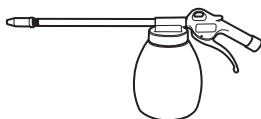

JWL Cleaning Gun with 1.2 L container and 260 mm metal nozzle.

142100-000



JWL Cleaning Gun with 1.2 L container and 145 mm metal nozzle.

142101-000

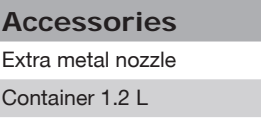

JWL Cleaning Gun with 1.2 L container and 1,000 mm metal nozzle.

142110-000

Accessories

Art. No.

Extra metal nozzle	142206
Container 1.2 L	143300
Container with lid 1.2 L	143160



JWL Brake Bleeder is easy to use for one person. Comes with or without replenishment system. Can also be used for MC.

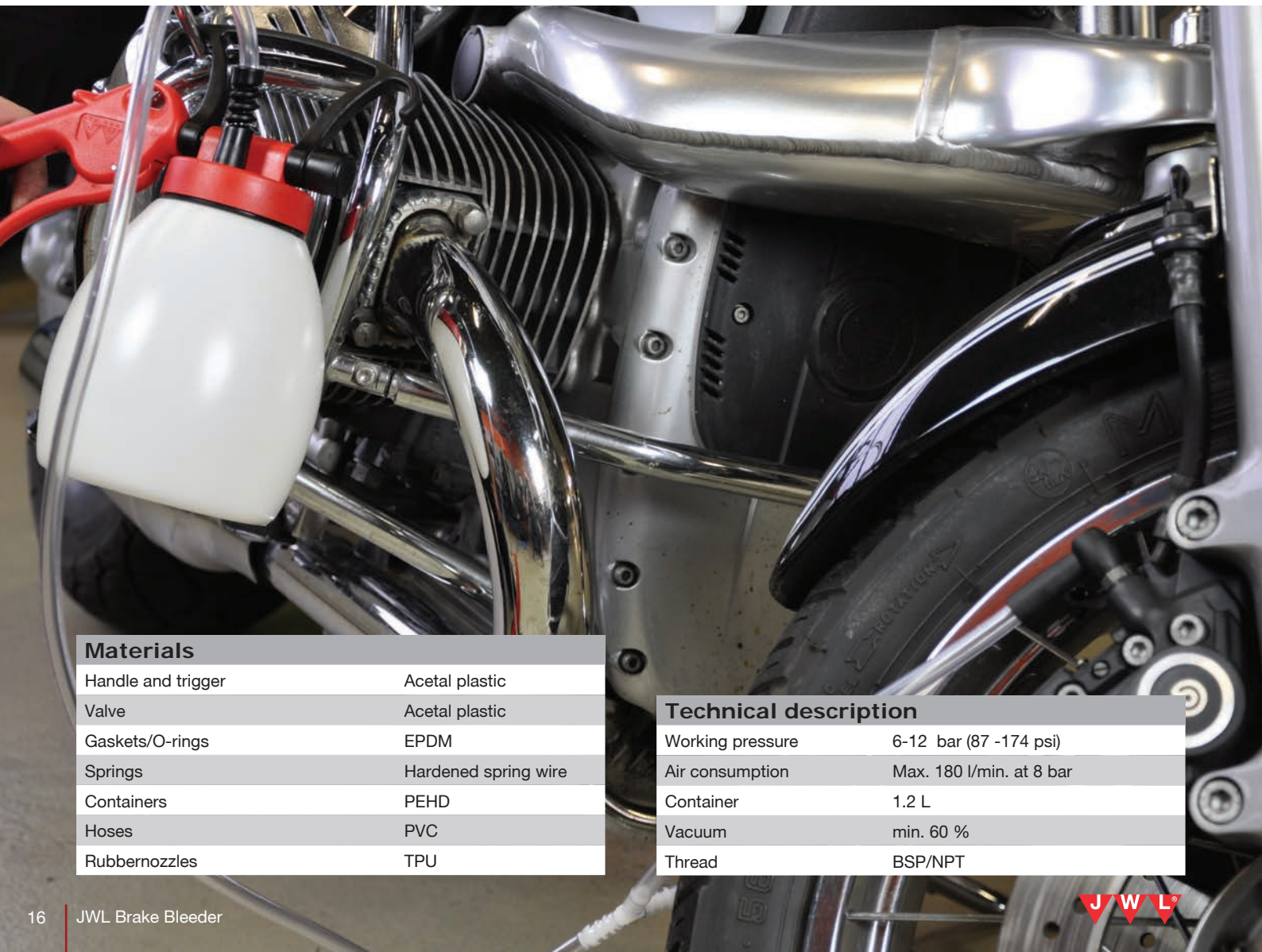

Materials

Handle and trigger	Acetal plastic
Valve	Acetal plastic
Gaskets/O-rings	EPDM
Springs	Hardened spring wire
Containers	PEHD
Hoses	PVC
Rubbernozzles	TPU

Technical description

Working pressure	6-12 bar (87 -174 psi)
Air consumption	Max. 180 l/min. at 8 bar
Container	1.2 L
Vacuum	min. 60 %
Thread	BSP/NPT

Brake Bleeder

JWL Brake Bleeders are used for quickly bleeding and refilling the brake systems of all types of vehicles. It can be operated by a single person. Brake bleeding is completed quickly, clean and simple. Brake fluid is pulled into the container avoiding spillages.

JWL Brake Bleeders are available in several models: with or without refilling systems, for cars and motorcycles and with or without safety valve, that prevents the fluid to atomize when the container is full. JWL Brake bleeders must never be used for explosive fluids, e.g. petrol and acetone.

JWL Brake Bleeders are approved and distributed by leading brake disc manufacturers.



How to use

With JWL Brake Bleeder, one person can carry out the bleeding of the brake systems.

DO NOT TOUCH THE BRAKE PEDAL WHILE BLEEDING THE BRAKES.

NOTE: MAINTENANCE AND CLEANING AFTER USE IS RECOMMENDED.

1. Connect the gun to the compressed air system.
2. Set the brake bleeder's rubber pipe on the brake system plug, and loosen the plug.
3. Activate the handle of the brake bleeder, a partial vacuum is created in the brake bleeder container, and the fluid is sucked into the container.
4. When the brake fluid is free of air bubbles, which can be seen through the clear hose, then tighten the bleeding plug and remove the rubber pipe.
5. Repeat the procedure for each brake calliper.
6. **REMEMBER** to check the fluid level.

JWL Brake Bleeders

Art. No.



JWL Brake Bleeder with 1.2 L container.

143102-000

JWL Brake Bleeder with 1.2 L container and safety valve.

143103-000



JWL Brake Bleeder with replenishment system and 1.2 L container.

143112-000

JWL Brake Bleeder with replenishment system, 1.2 L container and safety valve.

143113-000



JWL Brake Bleeder for MC with 1.2 L container.

143123-000

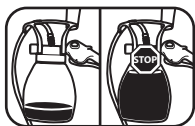

Safety valve. Suitable for all JWL Brake Bleeder models. The safety valve prevents the fluid to atomize when the container is full.

143267

Accessories

Art. No.

Container 1.2 L

143300

Container with lid 1.2 L

143160

Repair kit: hose, hose connectors, rubber pipe relief spring and O-ring

143155

Repair kit (MC): Y-piece, hose, hose connection, rubber pipe, hose relief & O-ring

143156

Silencer

143802-711

Rubber pipes (5-pack)

143166-000

O-rings (5-pack)

143164-000

Y-piece for MC

143804

Replenishment system

143150

JWL Underseal Gun with 1.2 L container.



JWL Underseal Gun for disposable canister.



146100-000



146134-000



146101-000



146102-000



146110-000

Materials

Handle and trigger	Acetal plastic
Valve	Acetal plastic
Gaskets/O-rings	Nitrile
Springs	Hardened spring wire
Container	PEHD

Technical description

Max. working pressure	16 bar (87 -174 psi)
Air consumption w/extension probe	Max. 180 l/min. at 8 bar
Air consumption w/nozzle	Max. 380 l/min. at 8 bar
Container	1.2 L
Thread	BSP/NPT



Underseal Guns

JWL Underseal Guns consist of a wide range of guns for treatment and maintenance of cars and other vehicles that are subject to corrosion and stone chipping. JWL Underseal Guns are developed in cooperation with leading manufacturers of anti-corrosion fluids.

JWL Underseal Guns are suitable for both water-based and oil-based fluids. Use plastic suction pipe for water based liquids and metal suction pipes for oil based liquids.







JWL Underseal Guns are designed to be user-friendly and operated quite easily. The fluid flow is adjustable and easily regulated with the trigger. The synthetic handle is pleasant to hold and never cools during use.

JWL Underseal Body Set is a flexible solution when working with various fluids of different viscosities and colours as the suction pipes are equipped with airtight JWL couplings. Thus, fluids can be changed without drying out.

JWL Underseal Guns are available with containers or suction pipes and screw lids that fit most disposable containers. The set is also available for both disposable and refillable containers.

All nozzles are easily replaced with cavity tubes or pipes.

NOTE: Clean after use to avoid clogging.

JWL Underseal Guns		Art. No.
	JWL Underseal Body gun with metal suction pipe and 1.2 L container. For oil based liquids.	146100-000
	JWL Underseal Body gun with 1.2 L container & extension probe. For oil based liquids.	146105-000
	JWL Underseal Body gun with plastic suction pipe. Fits disposable canisters.	146134-000
	JWL Underseal Body gun with plastic suction pipe & extension probe. For disposable canisters.	146135-000
	JWL Underseal Body gun with metal suction pipe. For disposable canisters. For oil based liquids.	146101-000
	JWL Underseal Body gun with metal suction pipe & extension probe. For disposable canisters and oil based liquids.	146109-000
	JWL Underseal Body Set with 1 suction pipe.	146107-000
	JWL Underseal Body Set with 1 suction pipe & extension probe.	146117-000
	JWL Underseal Body Set with 2 suction pipes for easy change between liquids.	146102-000
	JWL Underseal Body Set with 2 suction pipes for easy change between liquids. With volume control.	146103-000
	JWL Underseal Body Set with 2 suction pipes for easy change between liquids. With extension probe.	146108-000
	Extension probe ø8 mm x 600 mm with drip proof internal hose.	146115
	Extension probe ø8 mm x 900 mm with drip proof internal hose.	146110-000
	Extension probe ø8 mm x 1500 mm with drip proof internal hose.	146110-150
	Extension probe ø8 mm x 2000 mm with drip proof internal hose.	146110-200
	Extension probe ø8 mm x 3000 mm with drip proof internal hose.	146110-300

Accessories	Art. No.
Suction pipe for Body set for 146102-000, 146103-000, 146107-000 & 146108-000	146807-000
Extra plastic nozzle for 146110	142250
External POM nozzle for 146100 & 146134	146237
Container 1.2 L	143300
Container with lid 1.2 L	143160

JWL A/S
Teknikervej 4
DK-8722 Hedensted
Phone: +45 75 89 16 99
salg@jwl.dk
www.jwl.dk



The three triangles in the JWL logo symbolizes extremely high quality and precision within technical engineering. They commit and we have been committed to them since 1963, when Johannes Wagner Lund started JWL A/S.

We will continue to live up to the very high standards that we are respected for and proud of. The resourcefulness and creativity that prevail at JWL will secure user-friendly and innovative compressed air solutions that will last - for the next 50 years as well.

MADE IN DENMARK