



INSTRUCTIONS

Using this document you can customize the product based on your needs.

1. Choose the customization services to apply
 - Pad printing (i.e. colored logo) on:
 Cover Tray Base
 - Laser printing (i.e. wording and codes) on:
 Tray Base
2. Arrange the various elements on the tray and in the base, each element has different color variants to choose from. Remember that every page corresponds to one OLV One level, onto which you can only arrange those elements found on the page.
3. Choose the color of the cover and, if you wish, position your logo.
4. Send us your project by writing an email to info@ippi.it, and we will complete it together, giving you all the support you need. If you choose to customize the cover with your brand name, please send us that in vector format.

IMPORTANT NOTICE

The scale of the components outlines is 1:1. To print, set the scale to 100%. Once printed, the outlines will remain in proportion; for digital images, simply cut, copy and paste without resizing.



OLV One - Tray

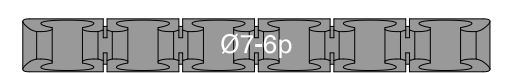
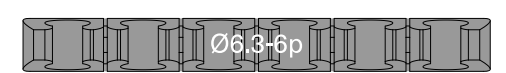
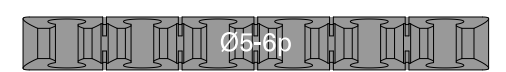
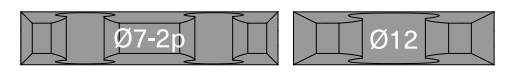
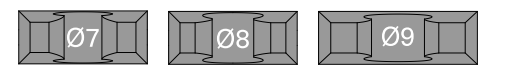
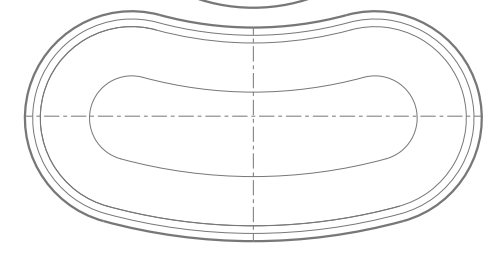
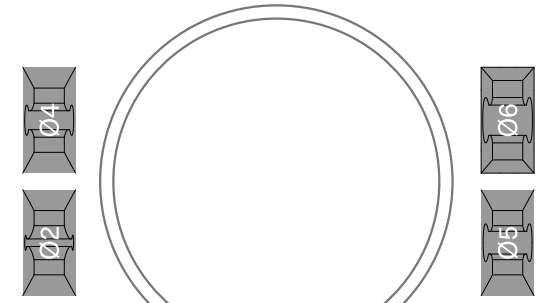
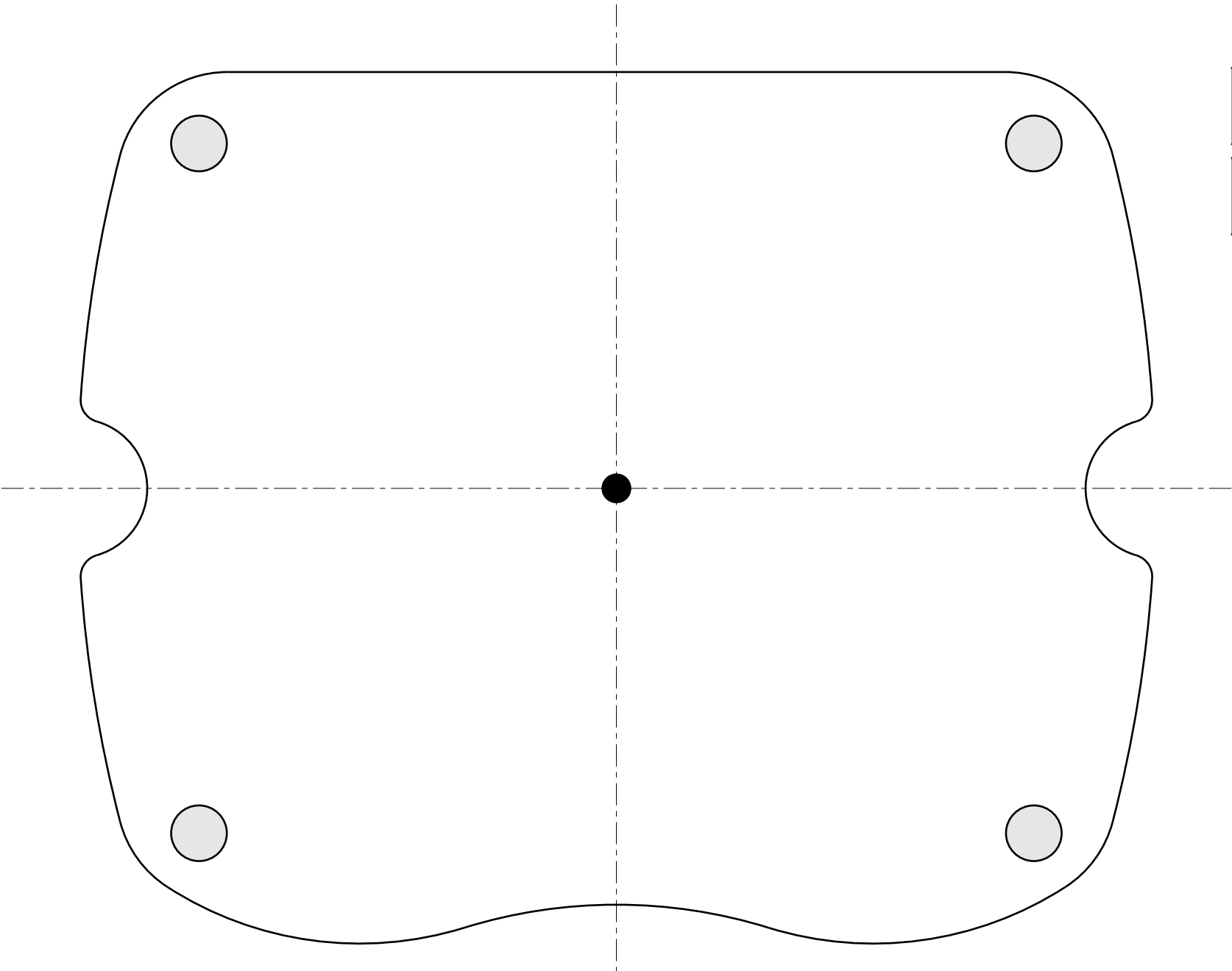
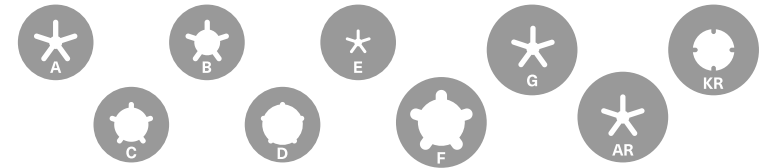



OLV One - Bottom

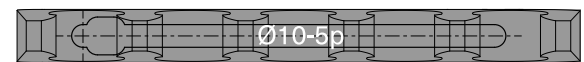
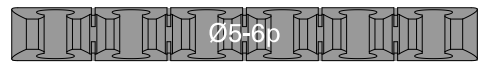
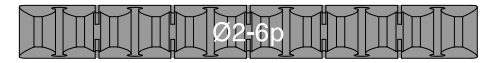
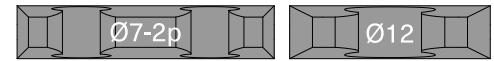
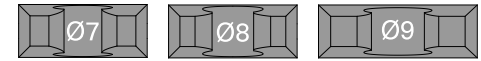
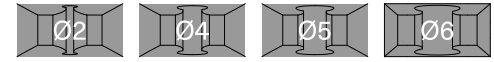
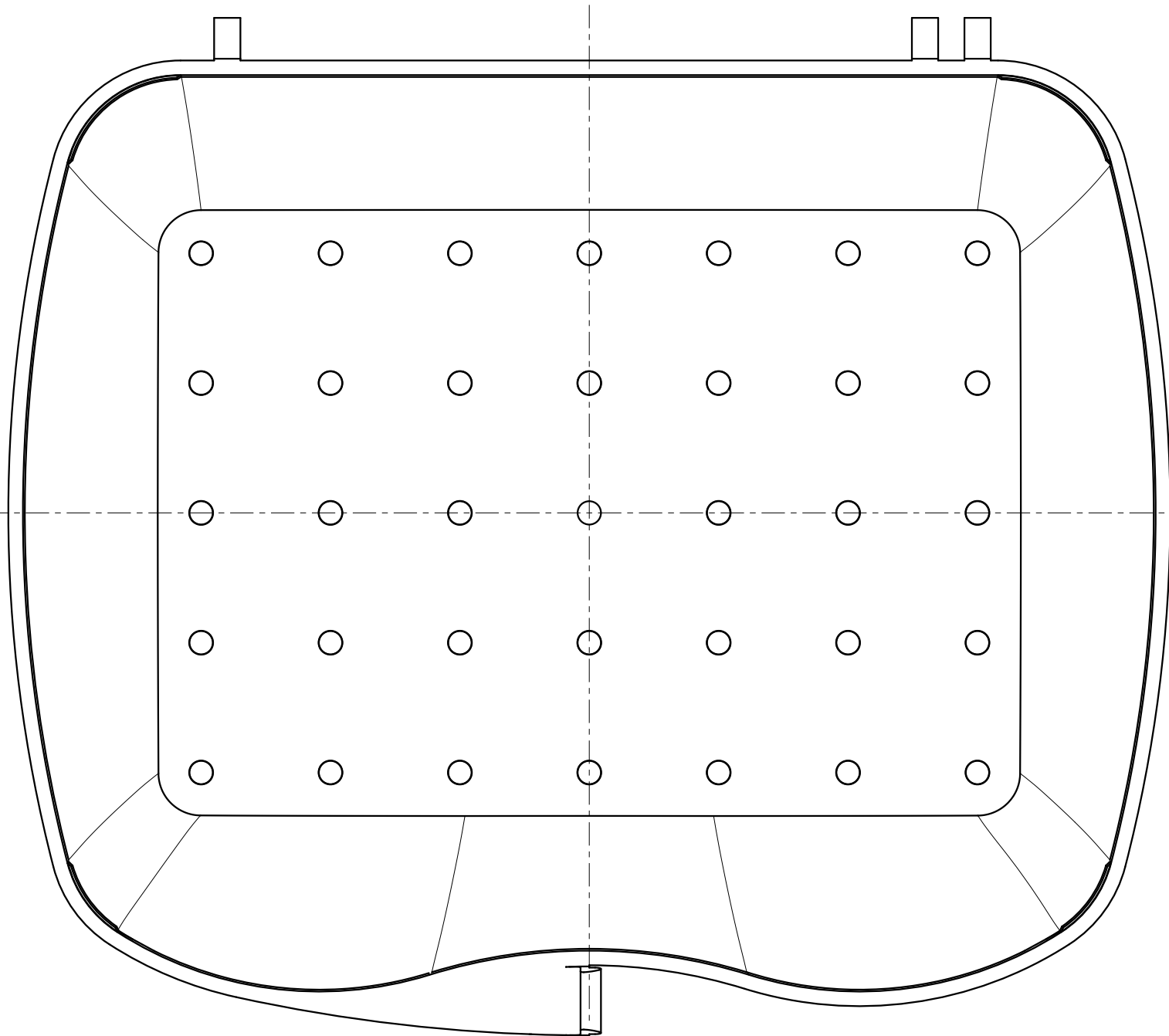



OLV One - Cover

