



Baltic
InteGrid

Integrated Baltic Offshore
Wind Electricity Grid Development



Offshore Wind Power Plant Technology Catalogue

Components of wind power plants, AC collection
systems and HVDC systems

Oct 2017

Offshore Wind Power Plant Technology Catalogue **Components of wind power plants, AC collection systems and HVDC systems**

By Kaushik Das, Nicolaos Antonios Cutululis, Department of Wind Energy
Technical University of Denmark, Denmark

Copyright:

Reproduction of this publication in whole or in part must include the customary bibliographic citation, including author attribution, report title, etc.

Cover photo: Copyright: Iberdola

Published by: Baltic InteGrid

Disclaimer:

The content of the report reflects the author's/partner's views and the EU Commission and the MA/JS are not liable for any use that may be made of the information contained therein. All images are copyrighted and property of their respective owners.

www.baltic-integrid.eu



Contents

1	Introduction	1
1.1	Motivation	3
1.2	Outline of the Report	3
2	Wind Turbines	4
2.1	Description	4
2.1.1	Doubly-fed Induction Generator (DFIG) based Wind Turbine	4
2.1.2	Fully Rated Converter (FRC) based Wind Turbine	4
2.2	Technical feasibilities	5
2.3	Stages of Development	5
2.4	Cost and Lifetime	5
3	AC Cables	7
3.1	Cross-linked polyethylene (XLPE) cables	7
3.1.1	Technical feasibilities	8
3.1.2	Stages of Development	9
3.1.3	Cost and Lifetime	9
3.2	High Temperature Superconducting (HTS) cables	9
3.2.1	Technical feasibilities	10
3.2.2	Stages of Development	10
3.2.3	Cost	10
4	HVDC Cables	11
4.1	Description	11
4.1.1	Self-Contained Fluid Filled Cables	11
4.1.2	Mass Impregnated Cables	11
4.1.3	Cross-Linked Poly-Ethylene Cables	13
4.2	Technical feasibilities	13
4.3	Stages of Development	14
4.4	Cost and Lifetime	14
5	AC-DC Converters	16
5.1	Line Commutated Converters	16
5.1.1	Description	16
5.1.2	Technical feasibilities	16
5.1.3	Stages of Development	18
5.1.4	Cost and Lifetime	18
5.2	Voltage Source Converters	18
5.2.1	Description	18
5.2.2	Technical feasibilities	18
5.2.3	Stages of Development	19
5.2.4	Cost and Lifetime	19
5.3	Diode Rectifier Units	19

5.3.1	Description	19
5.3.2	Technical feasibilities	20
5.3.3	Stages of Development	20
5.3.4	Cost and Lifetime	20
6	DC-DC Converters	21
6.1	Description	21
6.1.1	Isolated DC-DC Converters	22
6.1.2	Non-Isolated DC-DC Converters	23
6.2	Technical feasibilities	24
6.3	Stages of Development	24
6.4	Cost and Lifetime	24
7	Filters	25
7.1	Passive Filter	25
7.1.1	Description	25
7.1.2	Technical feasibilities	26
7.1.3	Stages of Development	26
7.1.4	Cost and Lifetime	26
7.2	Active Filter	26
7.2.1	Description	26
7.2.2	Technical feasibilities	28
7.2.3	Stages of Development	28
7.2.4	Cost and Lifetime	28
8	Reactive Compensation	29
8.1	Shunt Compensation	29
8.1.1	Description	29
8.1.2	Technical feasibilities	29
8.1.3	Stages of Development	30
8.1.4	Cost and Lifetime	30
8.2	Series Compensation	30
8.2.1	Description	30
8.2.2	Technical feasibilities	31
8.2.3	Stages of Development	31
8.2.4	Cost and Lifetime	31
9	Transformers	33
9.1	Description	33
9.2	Technical feasibilities	34
9.3	Stages of Development	34
9.4	Cost and Lifetime	34

10 Offshore Substructures	35
10.1 Description	35
10.1.1 Monopile Substructures	37
10.1.2 Tripod Substructures	37
10.1.3 Tripile Substructures	38
10.1.4 Jacket Substructures	38
10.1.5 Gravity substructures	38
10.1.6 Floating Substructures	39
10.2 Technical feasibilities	39
10.3 Stages of Development	40
10.4 Cost and Lifetime	41
11 Protection Equipment	42
11.1 AC Circuit Breaker	42
11.1.1 Description	42
11.1.2 Technical feasibilities	42
11.1.3 Stages of Development	43
11.1.4 Cost and Lifetime	43
11.2 DC Circuit Breaker	43
11.2.1 Description	43
11.2.2 Technical feasibilities	44
11.2.3 Stages of Development	44
11.2.4 Cost and Lifetime	45
11.3 Fault Current Limiter	45
11.3.1 Description	45
11.3.2 Technical feasibilities	45
11.3.3 Stages of Development	46
11.3.4 Cost and Lifetime	46
12 Auxiliary Equipment	47
12.1 Tapping equipment	47
12.1.1 Description	47
12.1.2 Technical feasibilities	47
12.1.3 Stages of Development	47
12.1.4 Cost and Lifetime	47
12.2 Supervisory, control and data acquisition (SCADA)	47
12.2.1 Description	47
12.2.2 Technical feasibilities	48
12.2.3 Stages of Development	48
12.2.4 Cost and Lifetime	48
13 Summary	49
Appendices	52
Appendix A HVDC Converter Station Configuration	52

Glossary

- AC** Alternating Current. 1, 2
- CSC** Current Source Converter. 2, 14
- DC** Direct Current. 2
- DFIG** Doubly-fed induction generator. 4
- DRU** diode rectifier unit. 17
- FRC** Fully Rated Converter. 4
- HTS** High Temperature Superconducting. 6, 8, 9
- HVAC** High Voltage Alternating Current. 1, 2, 6, 7, 10
- HVDC** High Voltage Direct Current. 1, 2, 10, 13, 14
- LCC** Line Commutated Converter. 12, 14–16
- MI** Mass Impregnated. 10
- MV** Medium Voltage. 1
- MVAC** Medium Voltage Alternating Current. 7
- OHL** Overhead Line. 2
- OWPP** Offshore Wind Power Plant. 1, 3, 14, 23
- PMSG** permanent magnet synchronous generator. 4
- TCSC** Thyristor Controlled Series Compensation. 28
- TRL** Technology Readiness Level. 3
- VSC** Voltage Source Converter. 2, 12, 14–16
- WPP** Wind Power Plant. 7, 8
- WRIG** wound rotor induction generator. 4
- WRSG** Wound rotor synchronous generator. 4
- WT** Wind Turbine. 1
- XLPE** Cross-linked polyethylene. 6, 7, 10

1 Introduction

Traditionally, Offshore Wind Power Plants (OWPPs) are connected through many components as shown in the figure 1. An OWPP consists of controllable, variable speed

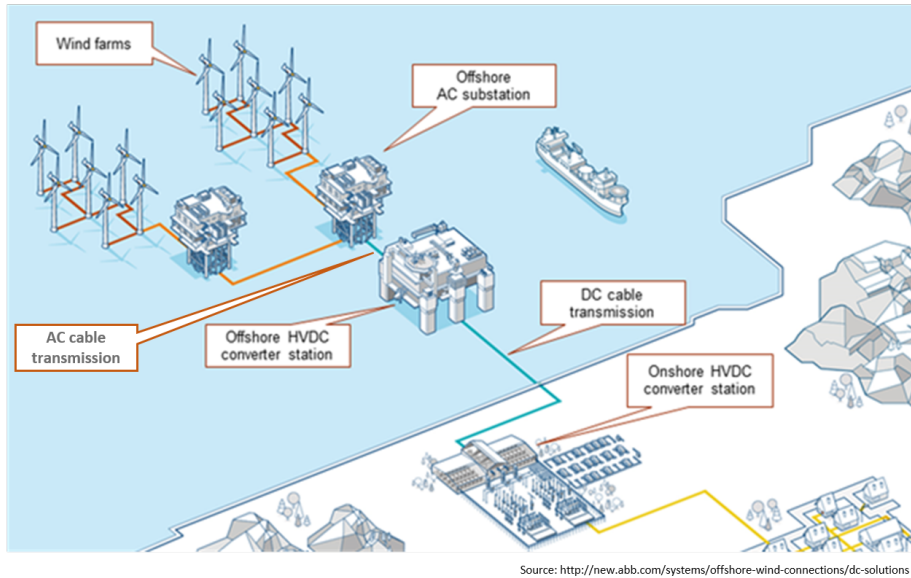

Figure 1: Traditional connection of offshore wind power plants

Wind Turbines (WTs). These WTs are connected through Medium Voltage (MV) submarine cables typically at voltage level of upto 33-66 kV to the Offshore Alternating Current (AC) substation. The transformer in offshore AC substation steps up the voltage to 132-200 kV for further transmission. The stepping up of voltage is important to reduce the current flow through the cables. Reduced current flow decreases the copper/aluminium requirement for the cables as well reduce the power losses through them.

Offshore AC substation can be connected to the grid at shore either directly through High Voltage Alternating Current (HVAC) cables or through High Voltage Direct Current (HVDC) converters and HVDC cables.

HVDC transmission technology has been developed and applied from as early as 1880s. In the early 1950s, HVDC transmission technology was used for the development of subsea interconnection with mercury arc valves used for electric AC/DC converters. HVDC transmission lines are applied when there is a need to transport high electrical power over long distances and/or in a controlled manner.

In terms of submarine applications, HVDC transmission technology is mainly applied either for connecting offshore platforms and OWPPs to land or for transmitting electricity over long distances through the sea where overhead lines cannot be used. Another subsea application can be for connecting the island networks to the mainland. HVDC transmission is the most viable solution available for the transfer of high

power across long subsea distances. However, choice between HVAC and HVDC is based on economic considerations. Furthermore, HVDC is a proven technology for transmission projects that interconnect asynchronous networks.¹ HVDC subsea transmission technology also has been largely applied in single point-to-point connections. The system approach gives the effective rating. Current maximum HVDC power under planning is up to ± 600 kV and 2200 MW per bipole as a system.² Looking into the future, meshed HVDC subsea systems may become available. However, development of meshed HVDC networks today is still limited as circuit breaker technology for DC grid is still not commercially matured. Circuit breakers, so called switchgear, secure the operation of the meshed HVDC system. As per the Europacable report,³ the development of this circuit breaker technology is in final development phase.

Vaféas et. al.⁴ studied and enumerated the benefits of HVDC technology over conventional HVAC in the REALISEGRID project. HVDC technology has been proved to be attractive for various applications such as long distance power transmission, long submarine cable links and interconnection of asynchronous systems. There are mainly two types of HVDC technology. The more recent technology is self-commutated Voltage Source Converter (VSC) technology. VSC technology is more flexible than the more conventional line-commutated Current Source Converter (CSC) since it allows controlling active and reactive power independently.⁵ Independent power flow controllability along with the advantage of increased transmission capacity can make HVDC technology preferable to conventional HVAC. Although the choice of HVDC vs. HVAC should be made based on economic studies; since the investment cost of a VSC-HVDC converter station is generally higher than HVAC substation. However, the overall investment costs of a Direct Current (DC) transmission link can be lower than those ones of a corresponding AC interconnection if a certain transmission distance is reached called “break-even” distance.⁶ The break-even distance upon which DC is more economical is project dependent (typically between 80 and 120 km for offshore submarine cable connections, while for onshore applications, the break-even distance between an AC and DC Overhead Line (OHL) is in the order of magnitude of 700 km)⁷ and the decision of using AC or DC should result from a techno-economic

1. Europacable, *An Introduction to High Voltage Direct Current (HVDC) Underground Cables*, http://www.europacable.eu/wp-content/uploads/2017/07/Introduction_to_HVDC_Underground_Cables_October_2011.pdf, 2011.

2. Europacable, *An Introduction to High Voltage Direct Current (HVDC) Subsea Cables Systems*, <http://www.europacable.eu/wp-content/uploads/2017/07/Introduction-to-HVDC-Subsea-Cables-16-July-2012.pdf>, 2012.

3. Ibid.

4. A Vaféas, S Galant, and T Pagano, “Final WP1 report on cost/benefit analysis of innovative technologies and grid technologies roadmap report validated by the external partners,” *REALISEGRID Deliverable D1* (2011).

5. Gianluigi Migliavacca, *Advanced technologies for future transmission grids* (Springer Science & Business Media, 2012).

6. Ibid.

7. A Vaféas, S Galant, and T Pagano, “Final WP1 report on cost/benefit analysis of innovative technologies and grid technologies roadmap report validated by the external partners,” *REALISEGRID Deliverable D1* (2011).

analysis including the line, station and losses components of costs.^{8,9}

1.1 Motivation

Building an offshore grid is a technically complex endeavour implying a significant number of components. While for AC connections the technology is mature and well known, in the area of power electronics and HVDC technology the component development is in its more incipient phases. This has prompted for the creation of a technology catalogue covering all the main components needed when developing offshore wind power and grids projects.

The main purpose of this Technology Catalogue is to serve as a common source for the techno-economic assessments done in the Baltic InteGrid project. To qualify for this, it should include both technical characteristics and cost parameters for all the relevant components of an OWPP and its connection to the grid.

The technology development has been classified in four main categories in this technology catalogue and described in Table 1. European definition of Technology Readiness Level (TRL)¹⁰ is associated with the categories.

Table 1: Categories of technology development

Category	Description	TRL ¹¹ today
mature	commercially available today - with (some) operational experience	9
young	full scale prototypes available - very close to commercialization	6-8
future	some prototypes available - but development still needed	4-5
distant future	proof of concept and small scale prototypes - significant development still needed	1-3

1.2 Outline of the Report

This report aims to cover most of the technical components for offshore network starting from wind turbines up to the onshore connecting substation. This report contains small description of each of the components followed by stages of development, cost and lifetime.

8. Patrick PANCIATICI et al., “e-HIGHWAY 2050 Modular Development Plan of the Pan-European Transmission System 2050.”

9. Gianluigi Migliavacca, *Advanced technologies for future transmission grids* (Springer Science & Business Media, 2012).

10. European Commission, *Technology readiness levels (TRL)*, https://ec.europa.eu/research/participants/data/ref/h2020/wp/2014_2015/annexes/h2020-wp1415-annex-g-trl_en.pdf.

2 Wind Turbines

2.1 Description

Wind turbine technology has been drastically improving and has become matured during the last decade. While wind turbine design objectives were traditionally convention-driven but they have been changed over these years to being optimized driven within the operating regime and market environment.¹² Not only the wind turbines have become larger in size, but also the wind turbine technology have progressed from fixed-speed, stall-controlled and with drive trains with gearboxes, to become pitch controlled, variable speed and with or without gearboxes.¹³ Decreasing cost of power electronics also increasingly supports the trend toward variable speed turbines.

Offshore wind turbines are categorically converter based variable speed wind turbines.¹⁴

The most commonly applied variable speed wind turbines can be categorized into two types:

2.1.1 Doubly-fed Induction Generator (DFIG) based Wind Turbine

Doubly-fed induction generator (DFIG) configuration represents variable speed controlled wind turbine with a wound rotor induction generator (WRIG) and partial-scale frequency converters (rated to approx. 30% of nominal generator power) on the rotor circuit. Stator of the wind turbine generator is directly connected to the grid. Partial-scale frequency converter controls rotor speed. The speed range of the rotor is dictated by power rating of the partial-scale frequency converter. Speed range is typically around *pm* 30% of the synchronous speed. The frequency converters can provide additional support like reactive power compensation.¹⁵

2.1.2 FRC based Wind Turbine

In this configuration, full variable speed control of the wind turbine is achieved through full-scale frequency converters. The generator is isolated from the grid through this full-scale frequency converter. The frequency converter provides additional supports like reactive power compensation and a smooth grid connection. FRC based wind turbine can operate in the entire speed range as opposed to limited speed range of DFIG. The generator can either be electrically excited (Wound rotor synchronous generator (WRSG)) or permanent magnet excited type (permanent magnet synchronous generator (PMSG)).¹⁶ Some FRC based wind turbines may have no gearbox but a bulky direct

12. Anca Daniela Hansen et al., "Grid integration impacts on wind turbine design and development," in *PowerTech, 2009 IEEE Bucharest* (IEEE, 2009), 1–7.

13. Anca D Hansen et al., "Review of contemporary wind turbine concepts and their market penetration," *Wind Engineering* 28, no. 3 (2004): 247–263.

14. Ibid.

15. Ibid.

16. Anca D Hansen et al., *Dynamic wind turbine models in power system simulation tool DIgSILENT*, technical report (2004).

driven multipole generator.¹⁷

2.2 Technical feasibilities

Installed offshore wind turbines are typically today in the 2-6 MW range, which is a mature and well proven technology today. According to Wind Europe,¹⁸ the average size of installed offshore wind turbine was 4.2 MW in 2015, a 13% increase over 2014. This was due to the increased deployment of 4-6 MW turbines in 2015.¹⁹ However, all the major wind turbine suppliers are commercially offering wind turbines in the 6-8 MW range^{20,21} with some of them being able to produce up to 9 MW,²² qualifying them as a young technology today, but with clear prospects and development timeline.

In the 10-20 MW range, there are no commercially available wind turbines today. However, research efforts in providing initial designs are being performed, mainly by academia. A 10 MW reference wind turbine design has been developed by Technical University of Denmark (DTU).²³ In the European project-INNWIND, this design was up-scaled to 20 MW,²⁴ however no detailed design data are available yet. This is considered a future technology.

2.3 Stages of Development

Mature

2.4 Cost and Lifetime

- Capex: 1500-2500 US\$/kW²⁵
- Opex: N/A

17. Anca D Hansen et al., "Review of contemporary wind turbine concepts and their market penetration," *Wind Engineering* 28, no. 3 (2004): 247–263.

18. EWEA, *The European offshore wind industry - key trends and statistics 2015*, 2016, <https://www.ewea.org/fileadmin/files/library/publications/statistics/EWEA-European-Offshore-Statistics-2015.pdf>.

19. Ibid.

20. Siemens Wind Power, *SWT-7.0-154*, <http://www.siemens.com/global/en/home/markets/wind/turbines/swt-7-0-154.html>.

21. Mitsubishi Vestas Offshore, *V164-8.0 MW*, <http://www.mhivestasoffshore.com/innovations/>.

22. Mitsubishi Vestas Offshore, *World's most powerful wind turbine once again smashes 24 hour power generation record as 9 MW wind turbine is launched*, <http://www.mhivestasoffshore.com/new-24-hour-record/>.

23. Bak, Christian and Zahle, Frederik and Bitsche, Robert and Kim, Taeseong and Yde, Anders and Henriksen, Lars Christian and Hansen, Morten Hartvig and Blasques, Jose Pedro Albergaria Amaral and Gaunaa, Mac and Natarajan, Anand, *The DTU 10-MW Reference Wind Turbine*, http://orbit.dtu.dk/files/55645274/The_DTU_10MW_Reference_Turbine_Christian_Bak.pdf, 2013.

24. *Innovative Wind Conversion Systems (10-20MW) for Offshore Applications, INNWIND Project*, www.innwind.eu.

25. Bak, Christian and Zahle, Frederik and Bitsche, Robert and Kim, Taeseong and Yde, Anders and Henriksen, Lars Christian and Hansen, Morten Hartvig and Blasques, Jose Pedro Albergaria Amaral and Gaunaa, Mac and Natarajan, Anand, *The DTU 10-MW Reference Wind Turbine*, http://orbit.dtu.dk/files/55645274/The_DTU_10MW_Reference_Turbine_Christian_Bak.pdf, 2013.

- lifetime: 20-25 years

3 AC Cables

Most prevalent types of HVAC Cables are Cross-linked polyethylene (XLPE) cables. Another technology, High Temperature Superconducting (HTS) cables is mature but their large application in electricity highways can be limited due to constraints of the cryogenic systems. However, HTS cables can be deployed in specific projects based on economic studies.

3.1 XLPE cables

XLPE cables belong to the class of extruded cables. Extruded cables can generally be categorized into 3 categories:

- EPR - ethylene propylene rubber
- PE - polyethylene
- XLPE - cross-linked polyethylene

Cross-linked polyethylene has good electrical properties such as low dielectric loss factor, which makes it feasible to operate at higher voltage than other kind of material like Poly Vinyl Chloride (PVC) insulated cables. Polyethylene as thermoplastic material is used as cable insulation but with applications limited by thermal constraints.²⁶ Cross-linking is performed in XLPE through the process known as ‘vulcanization’ or ‘curing’. Chemical additives are added to the polymer in small quantity which enable the molecular chains of the polymer to be cross-linked into a lattice structure.²⁷

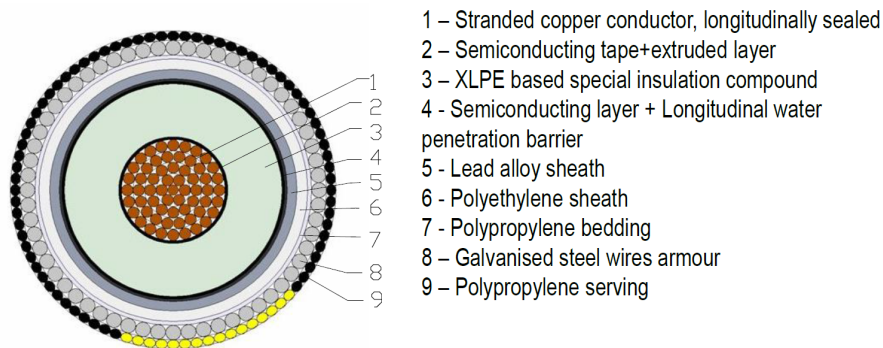

Figure 2: Example of XLPE cable design²⁸

Example of XLPE cable design is shown in Figure 2. Extruded insulation cables consist of many layers. Surrounding the conductors, there is inner semi-conducting

26. Eric Alwyn Reeves and Martin Heathcote, *Newnes electrical pocket book* (Routledge, 2013).

27. Ibid.

28. Europacable, *An Introduction to High Voltage Direct Current (HVDC) Subsea Cables Systems*, <http://www.europacable.eu/wp-content/uploads/2017/07/Introduction-to-HVDC-Subsea-Cables-16-July-2012.pdf>, 2012.

screen layer, the insulation compound and an outer semi-conducting insulation screen, extruded simultaneously.²⁹ A semi-conducting water swelling tape separates the outer semi-conducting screen and the metallic sheath limiting water propagation along the cable core in case of cable damage. A layer of polyethylene compound is extruded over the lead alloy based metallic sheath.³⁰

XLPE cables are used for both HVAC as well as Medium Voltage Alternating Current (MVAC).

3.1.1 Technical feasibilities

- Length: 20-100 km; However, maximum length depends on voltage rating and amount of shunt compensation.³¹
- Maximum Voltage: 500 kV³²
- Current Rating: 1.9-2.6 kA³³
- Cross-section: Example for Prysmian MVAC/HVAC cables is given in Table below.³⁴

Rated Voltage (kV)	Cross-section (mm^2)
66	240-2000
110	400-2500
132	400-2500
150	400-2500
220	630-2500
275	630-2500
345	800-2500
400	800-2500
500	1600-2500

- Deep Sea Installation: 400kV subsea cables can be either single core or 3-core. Although, sea depth does not influence maximum transmissible power through the cable, however, cable laying facilities can limit the cable diameter at the deepest water.³⁵

29. Soo-Bong Lee et al., "Development of 250kV HVDC XLPE cable system in Korea," in *Electrical Insulating Materials (ISEIM), Proceedings of 2014 International Symposium on* (IEEE, 2014), 334–337.

30. Europacable, *An Introduction to High Voltage Direct Current (HVDC) Subsea Cables Systems*, <http://www.europacable.eu/wp-content/uploads/2017/07/Introduction-to-HVDC-Subsea-Cables-16-July-2012.pdf>, 2012.

31. Grid Innovation Online, *Technology Database*, <http://www.gridinnovation-online.eu/Technology-Database>.

32. Prysmian, *High Voltage Cables*, http://nl.prysmiangroup.com/nl/business_markets/markets/hv-and-submarine/downloads/datasheets/Prysmian-Delft-HVAc.pdf.

33. Ibid.

34. Ibid.

35. Grid Innovation Online, *Technology Database*, <http://www.gridinnovation-online.eu/Technology-Database>.

3.1.2 Stages of Development

Mature

3.1.3 Cost and Lifetime

- Capex: 3675-4062 k€/km (installation cost = 29%)³⁶
- Opex: 7.3-8.1 k€/km (OPEX assumed at a 0.2% p.a.)³⁷
- Lifetime: N/A

The prices stated for the cables above also include installation costs that vary substantially depending on the area of application. For example, the prices for the XLPE-HVAC cables can be higher than that for the XLPE-HVDC cables. The reason is that the installation costs are included per km. The AC cables are mainly used for the array cabling of the Wind Power Plant (WPP), that means there are a lot of cables with a length of less than 1km. However, every cable needs lifting work and a connection on both ends. Therefore, extrapolating this cost to €/km can make the installation costs very high. Approximate CAPEX based on cable area of cross-section are as follows:

- 95mm² : 113k€/km
- 150mm² : 136k€/km
- 240mm² : 174k€/km
- 400mm² : 240k€/km
- 630mm² : 336k€/km

Installation costs are depending on the length and amount of lines of the WPP

3.2 HTS cables

The property of HTS to transmit power without resistance loss allows the utilities to increase power density by 2 to 8 times.³⁸

Benefits of HTS Power Cables³⁹

- Increased current carrying capability
- No resistive electrical losses
- Use of liquid nitrogen as coolant which is environmentally benign
- Can be installed into existing conduit infrastructure

36. Grid Innovation Online, *Technology Database*, <http://www.gridinnovation-online.eu/Technology-Database>.

37. Ibid.

38. SuperPower-Inc, *HTS Transmission Cable*, <http://www.superpower-inc.com/content/hts-transmission-cable>.

39. Ibid.

- Takes up less space than conventional cables therefore further expansion possible
- Increased power requirements of existing substations can be satisfied
- Can operate at high current levels with much lower losses also requiring less voltage transformations (reduced cost of transformers)

3.2.1 Technical feasibilities

- Length: 3 km; Although, there is no theoretical limitation in length however, actual maximum single length without joint installed is about 600 m. Major economic limitation for mass application of HTS lies mainly in the operation and maintenance of the cryogenic system.⁴⁰
- Maximum Voltage: 220 kV⁴¹
- Current Rating: 4 kA⁴²

3.2.2 Stages of Development

Mature

3.2.3 Cost

- Capex: N/A
- Opex: N/A
- Lifetime: N/A

Cost in future will depend on the evolution of the market and material properties of HTS in future.

40. Grid Innovation Online, *Technology Database*, <http://www.gridinnovation-on-line.eu/Technology-Database>.

41. Ibid.

42. Ibid.

4 HVDC Cables

4.1 Description

HVDC transmission technology is mainly applied when either transport of high electrical power over long distances becomes uneconomical for HVAC transmission; power transmission needs to be done with higher controllability and/or to connect two asynchronous networks.

Subsea application of HVDC transmission is predominantly used for connecting offshore wind farms to land or transmitting electricity over long distance through the sea where application of overhead lines may be technically or economically not feasible. However, HVDC cables are beginning to be used also for land transmission projects for transmitting high volume of power. HVDC is a proven technology for transmission projects that interconnect asynchronous networks.⁴³

HVDC underground cables are used to carry medium and high power (100 MW – 1,000 MW) over distances above 50 km. HVDC underground cables have been commercially used since the 1950s. Two types of HVDC cable technologies are mainly available commercially - Mass Impregnated (MI) Cables and XLPE Cables. Self-contained fluid filled cables are also becoming popular however they are used for very high voltage and short connections due to hydraulic limitations.⁴⁴

4.1.1 Self-Contained Fluid Filled Cables

Self-Contained Fluid Filled Cables are paper insulated oil filled cables. These kinds of cables are more suitable for HVDC transmission for short distances up to approximately 50 km. The insulation system in these cables need to be constantly under oil pressure. This oil pressure prevents from formation of cavities when oil contracts as the cable cools down. These kind of cables can be used for both AC and DC operations. Examples using low pressure oil filled cables are the interconnections between Saudi Arabia - Egypt (“Aqaba Project”) and the Spain-Morocco project.⁴⁵

4.1.2 Mass Impregnated Cables

Mass-impregnated subsea HVDC cables do not need oil feeding and therefore, there is no limitation in terms of length. Mass-impregnated cables are composed of a high viscous impregnating material which does not cause any leakage in events of cable damage/failure. Compared to oil filled cables, the compact design of Mass-impregnated subsea HVDC cables also allows for deep water applications. An example using mass-impregnated subsea HVDC cables is the interconnection between Spain - Mallorca

43. Europacable, *An Introduction to High Voltage Direct Current (HVDC) Underground Cables*, http://www.europacable.eu/wp-content/uploads/2017/07/Introduction_to_HVDC_Underground_Cables_October_2011.pdf, 2011.

44. Europacable, *An Introduction to High Voltage Direct Current (HVDC) Subsea Cables Systems*, <http://www.europacable.eu/wp-content/uploads/2017/07/Introduction-to-HVDC-Subsea-Cables-16-July-2012.pdf>, 2012.

45. Ibid.

(“Cometa Project”).⁴⁶

This type of cable is currently one of the most used, however, extruded cables are being used more and more in recent years as can be seen from Figure 3.^{47,48}

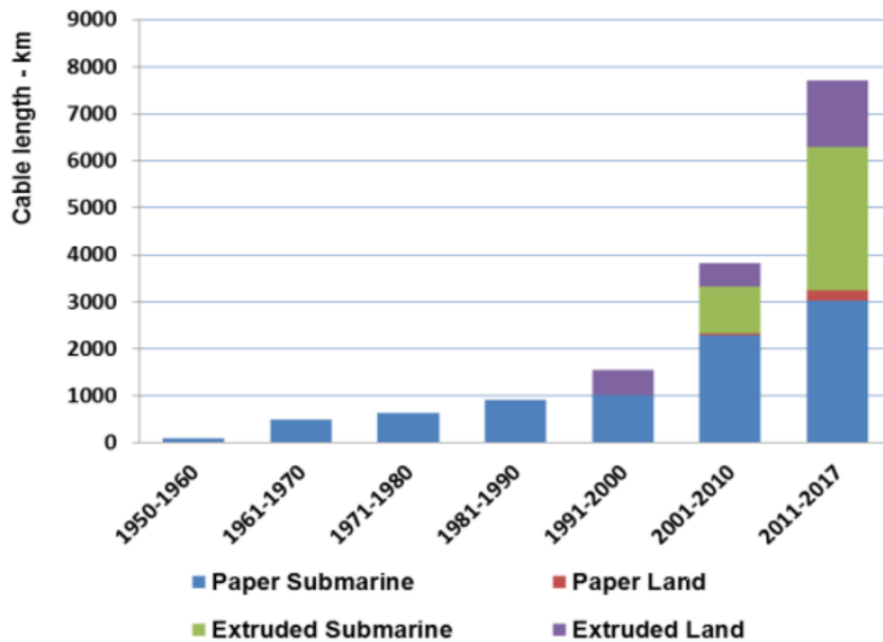

Figure 3: Evolution of length for mass impregnated paper cables and extruded cables for submarine and underground applications⁴⁹

Mass impregnated cables has been in service for many years and is a matured technology that can be used for voltages up to ± 500 kV and 1600 A DC which corresponds to a maximum pole rating of 800 MW and bipole rating of 1600 MW. Conductor sizes are typically up to 2500 mm^2 (at transmission capacity of 2000 MW bipole).

46. Europacable, *An Introduction to High Voltage Direct Current (HVDC) Subsea Cables Systems*, <http://www.europacable.eu/wp-content/uploads/2017/07/Introduction-to-HVDC-Subsea-Cables-16-July-2012.pdf>, 2012.

47. E. Zaccone, *High voltage underground and subsea cable technology options for future transmission in Europe*, presentation at E-Highway2050 WP3 workshop April 15th, 2014 Brussels, 2014, http://www.e-highway2050.eu/fileadmin/documents/Workshop4/7b_Europacable_for_WP3_Workshop_Technology_Presentation_15_April_2014_c.pdf.

48. Mircea Ardelean and Philip Minnebo, *HVDC Submarine Power Cables in the World*, JRC Technical Reports, 2015, <http://publications.jrc.ec.europa.eu/repository/bitstream/JRC97720/ld-na-27527-en-n.pdf>.

49. E. Zaccone, *High voltage underground and subsea cable technology options for future transmission in Europe*, presentation at E-Highway2050 WP3 workshop April 15th, 2014 Brussels, 2014, http://www.e-highway2050.eu/fileadmin/documents/Workshop4/7b_Europacable_for_WP3_Workshop_Technology_Presentation_15_April_2014_c.pdf.

Further improvement in voltage and capacity can be expected in the near future.⁵⁰

4.1.3 Cross-Linked Poly-Ethylene Cables

Polymeric cables are only used in Voltage Source Converters(VSC) applications that allow reversing power flow without reversing the polarity.⁵¹ This technology has mainly been applied at voltages up to ± 200 kV (in service with a power capacity of 400 MW). However, recent project such as European TEN-E France - Spain Interconnector (IN-ELFE) has voltage rating of ± 320 kV and power rating of 1000 MW per cable.^{52,53}

4.2 Technical feasibilities

- HVDC cables: XLPE
 - Transmission Distance: > 1000 km⁵⁴
 - Losses: 27 W/m (21 W/m in future) (Typical losses per circuit (bipole))⁵⁵
 - Maximum Voltage: 400-525-640 kV^{56,57}
Recently 640 kV extruded HVDC cable system has been developed, however, mainly for underground applications.⁵⁸
 - Current rating: 1900 kA⁵⁹
 - Max Power per VSC substation (bipole): 1524-1710 MW (1710-1895 MW in future)⁶⁰
 - Max Power per LCC substation (bipole): 600 MW⁶¹

50. Europacable, *An Introduction to High Voltage Direct Current (HVDC) Subsea Cables Systems*, <http://www.europacable.eu/wp-content/uploads/2017/07/Introduction-to-HVDC-Subsea-Cables-16-July-2012.pdf>, 2012.

51. Europacable, *An Introduction to High Voltage Direct Current (HVDC) Underground Cables*, http://www.europacable.eu/wp-content/uploads/2017/07/Introduction_to_HVDC_Underground_Cables_October_2011.pdf, 2011.

52. Europacable, *An Introduction to High Voltage Direct Current (HVDC) Subsea Cables Systems*, <http://www.europacable.eu/wp-content/uploads/2017/07/Introduction-to-HVDC-Subsea-Cables-16-July-2012.pdf>, 2012.

53. P Labra Francos et al., "INELFE—Europe's first integrated onshore HVDC interconnection," in *Power and Energy Society General Meeting, 2012 IEEE (IEEE, 2012)*, 1–8.

54. Grid Innovation Online, *Technology Database*, <http://www.gridinnovation-on-line.eu/Technology-Database>.

55. Ibid.

56. Ibid.

57. ABB, *The new 525 kV extruded HVDC cable system*, 2014, <https://library.e.abb.com/public/7caadd110d270de5c1257d3b002ff3ee/The%5C%20new%5C%20525%5C%20kV%5C%20extruded%5C%20HVDC%5C%20cable%5C%20system%5C%20White%5C%20PaperFINAL.pdf>.

58. NKT, *640 kV extruded HVDC cable system*, 2017, http://www.nkt.de/fileadmin/user_upload/01_Page_images_global/general_images_pages/About_us/Innovation/640_kV_extruded_HVDC.pdf.

59. Grid Innovation Online, *Technology Database*, <http://www.gridinnovation-on-line.eu/Technology-Database>.

60. Ibid.

61. Ibid.

- Cross-section Area: 2500 mm² for voltage rating of 320 kV⁶²
- Deep sea installations: 500 m (1000 m in future)⁶³

- HVDC cables: MI

- Losses: 10.4 W/m⁶⁴
- Maximum Voltage: 600 kV⁶⁵
- Current rating: 1555 kA (1950 kA in future)⁶⁶
- Max Power per VSC substation (bipole): 1860 MW⁶⁷
- Max Power per Line Commutated Converter (LCC) substation (bipole): 1860 MW⁶⁸
- Cross-section Area: 2000 mm² for 300 kV⁶⁹
- Deep sea installations: 1600 m (2000 m in future)⁷⁰

Europe's longest interconnector: NordLink project with VSC converters rated at +/- 525 kV and 1400 MW bipole configuration having route length of 623 km route length is being built⁷¹

4.3 Stages of Development

Mature

4.4 Cost and Lifetime

- HVDC cables: XLPE
 - Capex: 1470-1625 k€/ km (Installation costs: 29%)⁷²
 - Opex: 2.9-3.2 k€/km (OPEX assumed at a 0.2% p.a.)⁷³

62. ENTSO-E, *Offshore Transmission Technology*, http://www.benelux.int/files/6814/0923/4514/offshore_grid_technology.pdf.

63. Grid Innovation Online, *Technology Database*, <http://www.gridinnovation-on-line.eu/Technology-Database>.

64. Ibid.

65. Ibid.

66. Ibid.

67. Ibid.

68. Ibid.

69. *Northern Pass Project-Diagrams of Cross-Section of Underground Cables*, <https://energy.gov/sites/prod/files/2013/08/f2/Exhibit%20-%20Diagrams%20of%20Cross-Section%20of%20Underground%20Cables.pdf>.

70. Grid Innovation Online, *Technology Database*.

71. Magnus Callavik, Peter Lundberg, and O Hansson, "NORDLINK Pioneering VSC-HVDC interconnector between Norway and Germany," *ABB White Paper*, 2015,

72. Grid Innovation Online, *Technology Database*, <http://www.gridinnovation-on-line.eu/Technology-Database>.

73. Ibid.

- lifespan: >40 years⁷⁴
- HVDC cables: MI
 - Capex: N/A
 - Opex: N/A
 - lifespan: >40 years⁷⁵
- HVDC cables: Self-Contained Fluid Filled
 - Capex: N/A
 - Opex: N/A
 - lifespan: N/A

Experience of HVDC underground cabling and their cost is currently limited. Based on analysis conducted by Realise Grid⁷⁶ in 2010, the cost of HVDC underground cables (two cables, \pm 350 kV, 1,100 MW) is between 1 - 2.5 million €/km. Some estimations of costs for HVDC cables for different cross-sections can be found in some reports.^{77,78,79}

74. Grid Innovation Online, *Technology Database*, <http://www.gridinnovation-on-line.eu/Technology-Database>.

75. Ibid.

76. *EU-FP7 project - REseArch, methodoLogies and technologieS for the effective development of pan-European key GRID infrastructures to support the achievement of a reliable, competitive and sustainable electrical supply*, <http://realisegrid.rse-web.it/>.

77. Kalid Yunus, “Steady state analysis of HVDC grid with Wind Power Plants” (PhD diss., Chalmers University of Technology, 2017).

78. ENTSO-E, *Offshore Transmission Technology*, http://www.benelux.int/files/6814/0923/4514/offshore_grid_technology.pdf.

79. REALISEGRID, *D3.3.2 Review of costs of transmission infrastructures, including cross border connections*, http://realisegrid.rse-web.it/content/files/File/Publications%5C%20and%5C%20results/Deliverable_REALISEGRID_3.3.2.pdf.

5 AC-DC Converters

All the electricity transmission and distribution networks in the world are based on AC systems. In order to transmit power from far off OWPP through HVDC cables, AC power are converted to DC power and vice versa using AC-DC power converters. Power converters currently available on the market can be classified in two major categories in terms of technology: Line Commutated Converters(LCC) and Voltage Source Converter (VSC).⁸⁰ Both of these type of technologies can be used in a full HVDC scheme (AC/DC converter - HVDC line or cable - DC/AC converter) or in a back-to-back (B2B) HVDC scheme (AC/DC converter - DC circuit - DC/AC converter, with all these components installed in a single station) or a more recent configuration for multi-terminal HVDC (MTDC) applications.⁸¹

LCC and VSC have different characteristics and are operated in different manner because of the intrinsic differences of power electronic components. The characteristics of LCC and VSC are compared in Table 2.

5.1 Line Commutated Converters

5.1.1 Description

LCC or CSC are the conventional, mature and well established power converter technology which has been used to convert electrical current from AC to DC and vice versa since early 1950. Such converters require robust AC voltage source at either end. Multi-terminal LCC connections are possible and exist (two schemes exist). However, larger systems with a more complex structure may not be practical configuration mainly due to limitations on controllability of LCC converters.⁸²

5.1.2 Technical feasibilities

- Voltage (line to ground) for converter: 800-1100 kV⁸³
- Voltage (line to ground) for cables: 550 kV⁸⁴
- Current: 4-5 kA (6 kA in future)⁸⁵
- Max Power per substation (bipole) : 8-11 GW (upto 13.2 GW in future)⁸⁶

80. Europacable, *An Introduction to High Voltage Direct Current (HVDC) Subsea Cables Systems*, <http://www.europacable.eu/wp-content/uploads/2017/07/Introduction-to-HVDC-Subsea-Cables-16-July-2012.pdf>, 2012.

81. e-Highway2050, *Technology Assessment Report (HVDC) - Annex to D3.1 - Technology Assessment Report*, http://www.e-highway2050.eu/fileadmin/documents/Results/D3/report_HVDC.pdf, 2014.

82. Ibid.

83. Grid Innovation Online, *Technology Database*, <http://www.gridinnovation-on-line.eu/Technology-Database>.

84. Ibid.

85. Ibid.

86. Grid Innovation Online, *Technology Database*, <http://www.gridinnovation-on-line.eu/Technology-Database>.

Table 2: Comparison between LCC and VSC

LCC	VSC
<u>Background</u>	<u>Background</u>
<ul style="list-style-type: none"> • Also known as Current Source Converter (CSC) • Since early 1950 • Typically uses thyristors • Connected by two power networks at either side of link 	<ul style="list-style-type: none"> • Since 1999 • Contrary to CSC, can also be used for connecting isolated networks to the grid, e.g. supply power from generation sources like WPPs or to remote islands. • Recent technology, compact VSC Multilevel Converters have lower losses
<u>Key characteristics of LCC</u>	<u>Key characteristics of VSC</u>
<ul style="list-style-type: none"> • More powerful • Low losses • Requires robust networks in operation on both sides and therefore can be preferred technology for interconnections of synchronous networks • Requires more space than VSC depending on power rating and therefore preferred on land • Induces more severe requirements for cables, therefore cables designed for LCC can also be used for VSC, but not vice versa. 	<ul style="list-style-type: none"> • Younger technology • Able of “black start” (i.e. able to start without additional power at either end) • Currently limited in power (in the order of 3000 MW) and voltage (up to ± 640 kV) • More flexible, smaller and lighter and therefore preferable for offshore applications. • Allows independent control of active and reactive power.

- Maximum length of the line: 2000 km⁸⁷
- Maximum length of the cable: 580-600 km⁸⁸
- Transmission Losses: 0.7-1.1% of rated power per converter station.⁸⁹ A converter station usually contains converters, capacitors or synchronous condensers for reactive power, filters for harmonic suppression, switch gears, auxillary equipment and transformers.

⁸⁷. Grid Innovation Online, *Technology Database*, <http://www.gridinnovation-on-line.eu/Technology-Database>.

⁸⁸. Ibid.

⁸⁹. Ibid.

5.1.3 Stages of Development

Mature

5.1.4 Cost and Lifetime

- Capex: 101-112 M€/GW (Installation costs: 37%)⁹⁰
- Opex: 2% of investment costs per year⁹¹
- lifetime: 40 years⁹²

Cost ranges are given per “per terminal” for the typical 1000 MW LCC configuration at 2013.⁹³

5.2 Voltage Source Converters

5.2.1 Description

VSC are self-commutated converters using devices suitable for high power and high voltage applications. This technology can rapidly control both active and reactive power independently.⁹⁴ It allows higher flexibility and controllability to place converters at different locations in the AC network since no robust AC voltage source is required to be connected at its end. Although there are some technology challenges that still needs to be addressed, such as DC breakers, higher powers, losses reduction etc. for larger deployment in multi-terminal applications.⁹⁵

5.2.2 Technical feasibilities

- Voltage (line to ground) for converter: 500-800 kV (1100 kV in future)⁹⁶
- Voltage (line to ground) for cables: 500 kV⁹⁷
- Current: 1.5-3 kA (3-4 kA in future)⁹⁸
- Max Power per substation (bipole) : 2000-4800 MW (6400 MW in future)⁹⁹

90. Grid Innovation Online, *Technology Database*, <http://www.gridinnovation-on-line.eu/Technology-Database>.

91. Ibid.

92. Ibid.

93. Ibid.

94. J Duncan Glover, Mulukutla S Sarma, and Thomas Overbye, *Power System Analysis & Design, SI Version* (Cengage Learning, 2012).

95. e-Highway2050, *Technology Assessment Report (HVDC) - Annex to D3.1 - Technology Assessment Report*, http://www.e-highway2050.eu/fileadmin/documents/Results/D3/report_HVDC.pdf, 2014.

96. Grid Innovation Online, *Technology Database*, <http://www.gridinnovation-on-line.eu/Technology-Database>.

97. Ibid.

98. Ibid.

99. Ibid.

- Maximum length of the line: 700-2000 km (3000 km in future)¹⁰⁰
- Maximum length of the cable: 400 km¹⁰¹ (600-1000 km in future)¹⁰²
760 km long HVDC interconnector called Viking Link between Denmark and UK is being proposed.¹⁰³
- Transmission Losses: 0.9-1.3% of rated power (0.7-1.1% in future) per converter station.¹⁰⁴ A converter station usually contains converters, capacitors or synchronous condensers for reactive power, filters for harmonic suppression, switch gears, auxiliary equipment and transformers.

5.2.3 Stages of Development

Mature

5.2.4 Cost and Lifetime

- Capex: 106-118 k€/MW (Installation costs: 31%)¹⁰⁵
- O&M costs: 2% of investment costs per year¹⁰⁶
- Lifetime: 40 years¹⁰⁷

Cost ranges are given per “per terminal” for typical configuration of a bipolar VSC terminal of power rating of 1100 MW at 2013.¹⁰⁸ Some estimations of costs for VSC for different power ratings can be found in some reports as well.^{109, 110, 111}

5.3 Diode Rectifier Units

5.3.1 Description

The design of diode rectifier unit (DRU) developed from an idea originated at the University of Valencia in Spain, replaces the air-insulated IGBT based traditional converter

100. Grid Innovation Online, *Technology Database*, <http://www.gridinnovation-on-line.eu/Technology-Database>.

101. *NordBalt*, <https://en.wikipedia.org/wiki/NordBalt>.

102. Grid Innovation Online, *Technology Database*, <http://www.gridinnovation-on-line.eu/Technology-Database>.

103. *Viking Link*, <http://viking-link.com/>.

104. Grid Innovation Online, *Technology Database*, <http://www.gridinnovation-on-line.eu/Technology-Database>.

105. Ibid.

106. Ibid.

107. Ibid.

108. Ibid.

109. Kalid Yunus, “Steady state analysis of HVDC grid with Wind Power Plants” (PhD diss., Chalmers University of Technology, 2017).

110. ENTSO-E, *Offshore Transmission Technology*, http://www.benelux.int/files/6814/0923/4514/offshore_grid_technology.pdf.

111. REALISEGRID, *D3.3.2 Review of costs of transmission infrastructures, including cross border connections*, http://realisegrid.rse-web.it/content/files/File/Publications%5C%20and%5C%20results/Deliverable_REALISEGRID_3.3.2.pdf.

and air-insulated DC switch gear — which requires much space and costly air conditioning with diode rectifiers.

For example, a 0.9GW VSC requires 50,000 cubic metres of space. Whereas, DRU with a 1.2GW rating requires three platforms each with a pair of DRUs converting from 66kV to 106.7kV strung together to add up to 320kV as provided by the VSCs used today. The three platforms have a total volume of just 6,500 cubic metres, or a nearly 90% volume saving on the VSC platform.¹¹²

DRU are simple, robust, encapsulated and have low losses & low maintenance costs. However, DRU does not allow bidirectional power flow as compared to VSC technology. Since WTs need auxiliary power to maintain systems, mainly grid outage; therefore additional AC cable is needed running parallel to the DC cables from the onshore network.

AC voltage control is performed by the WTs

5.3.2 Technical feasibilities

- Nominal power: 200 MW¹¹³
- Nominal voltage AC: 66 kV¹¹⁴
- Nominal voltage DC: 106.7 kV¹¹⁵
- Size fits for transport by road and ship¹¹⁶
- Bio degradable and flame retardant ester insulation¹¹⁷

5.3.3 Stages of Development

Future

5.3.4 Cost and Lifetime

- Capex: N/A
- Opex: N/A
- lifetime: N/A

112. Sara Knight, *Analysis: Siemens' radical substation plan*, News Article - WindPower Offshore, 2015, <http://www.windpoweroffshore.com/article/1338456/analysis-siemens-radical-substation-plan>.

113. Grid Innovation Online, *Technology Database*, <http://www.gridinnovation-online.eu/Technology-Database>.

114. Ibid.

115. Ibid.

116. Ibid.

117. Ibid.

6 DC-DC Converters

6.1 Description

This would be a device to convert one DC voltage to another DC voltage level and have equivalent function of a transformer in an AC grid. The AC transformer has greatly facilitated AC transmission systems to operate at different voltage levels (110kV, 220kV, 400kV etc.) optimising the AC grid and its components. The DC equivalent can fulfil the same function in future HVDC grid also sometimes referred as Supergrid. Unless the Supergrid is specifically designed to operate at a common DC voltage, DC-DC converters will be essentially required to combine DC networks at different voltage levels.^{118,119}

There has been some recent standardisation efforts to unify voltage levels and to avoid the need for DC-DC conversion. However, still different voltage levels may appear. For example, several different DC voltage levels are already applied for offshore wind integration in Germany. The fast progress in converter and cable technology also implies that significantly higher voltages can be foreseen in future. Utilising a standard voltage would waste future possible benefits from improved future voltage ratings.

There are generally two possibilities to connect two different DC voltage levels:

- With a DC-DC converter
- Through regular 50 Hz AC with an DC-AC converter and an AC-DC converter¹²⁰

A DC-DC converter is likely to be cheaper and more efficient than two separate converters with regular 50Hz AC in between.¹²¹ DC-DC converter also has the advantage to regulate the current or power flow through the converter, which helps to operate a meshed DC grid. It could even be applied for this purpose only, connecting two buses of the same voltage level. However, there is other component specialised for this kind of function called DC current flow controller.^{122,123}

DC-DC converters topologies can be effectively classified into two groups:¹²⁴

- Isolated DC-DC Converters
- Non-isolated DC-DC Converters

118. e-Highway2050, *Technology Assessment Report (HVDC) - Annex to D3.1 - Technology Assessment Report*, http://www.e-highway2050.eu/fileadmin/documents/Results/D3/report_HVDC.pdf, 2014.

119. Friends of the SuperGrid, *Roadmap to the Supergrid Technologies*, http://mainstream-downloads.opendebate.co.uk/downloads/WG2_Roadmap_to_the_Supergrid_Technologies_2013_Final_v2.pdf, 2013.

120. Til Kristian Vrana and Raymundo E Torres Olguin, "Technology perspectives of the North Sea Offshore and storage Network (NSON)," 2015,

121. Ibid.

122. Ibid.

123. CD Barker and RS Whitehouse, "A current flow controller for use in HVDC grids," in *10th IET International Conference on AC and DC Power Transmission (ACDC 2012)* (IET, 2012).

124. Til Kristian Vrana and Raymundo E Torres Olguin, "Technology perspectives of the North Sea Offshore and storage Network (NSON)," 2015,

6.1.1 Isolated DC-DC Converters

In an isolated DC-DC converter, the input and the output port are isolated using galvanic insulation. Isolated DC-DC converter comprises of two AC-DC converters connected to each other by a transformer. Example of possible topology is shown in Figure 4. Main design parameters of an isolated DC-DC converter are switching frequency and

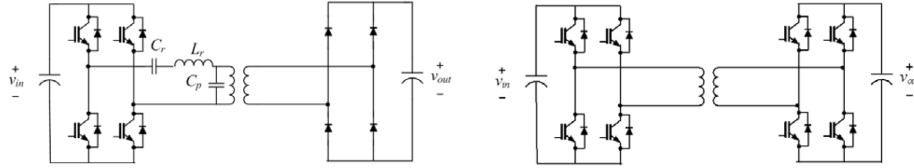

Figure 4: Isolated DC-DC converters
left: Resonant bridge converter; right: Dual active bridge converter¹²⁵

AC side frequency. AC side frequency is typically higher than the network nominal frequency (50/60 Hz). Operating in high frequency can allow for significant reduction of the size and volume of the transformers and components like capacitors and inductors. However, a higher frequency leads to increased power losses and complex design of transformer (e.g. amorphous core materials, Litz wires).^{126, 127, 128}

Availability of DC-DC converter for high power application as market product is rather limited and studied academically for power ratings spanning from tens of kV to a few MWs and with an AC operating frequency in the kHz range using several topologies.^{129, 130, 131, 132, 133}

125. Til Kristian Vrana and Raymundo E Torres Olguin, “Technology perspectives of the North Sea Offshore and storage Network (NSON),” 2015.

126. Robert L Steigerwald, Rik W De Doncker, and H Kheraluwala, “A comparison of high-power DC-DC soft-switched converter topologies,” *IEEE transactions on industry applications* 32, no. 5 (1996): 1139–1145.

127. Abdelrahman Hagar, “A new family of transformerless modular DC-DC converters for high power applications” (PhD diss., University of Toronto, 2011).

128. Til Kristian Vrana and Raymundo E Torres Olguin, “Technology perspectives of the North Sea Offshore and storage Network (NSON),” 2015.

129. J Taufiq, “Power electronics technologies for railway vehicles,” in *Power Conversion Conference-Nagoya, 2007. PCC’07* (IEEE, 2007), 1388–1393.

130. Liyu Yang et al., “Design and analysis of a 270kW five-level dc/dc converter for solid state transformer using 10kV SiC power devices,” in *Power Electronics Specialists Conference, 2007. PESC 2007. IEEE* (IEEE, 2007), 245–251.

131. Michael Steiner and Harry Reinold, “Medium frequency topology in railway applications,” in *Power Electronics and Applications, 2007 European Conference on* (IEEE, 2007), 1–10.

132. G Ortiz et al., “1 Megawatt, 20 kHz, isolated, bidirectional 12kV to 1.2 kV DC-DC converter for renewable energy applications,” in *Power Electronics Conference (IPEC), 2010 International* (IEEE, 2010), 3212–3219.

133. Stephan Meier et al., “Design considerations for medium-frequency power transformers in offshore wind farms,” in *Power Electronics and Applications, 2009. EPE’09. 13th European Conference on* (IEEE, 2009), 1–12.

6.1.2 Non-Isolated DC-DC Converters

Non-isolated DC-DC converters are structurally simpler, cheaper and smaller than isolated converters.^{134,135} Two topologies are shown as an example in Figure 5. However, these converters are only capable of achieving a limited voltage ratio, which reduces the scope of application for these types of converters.

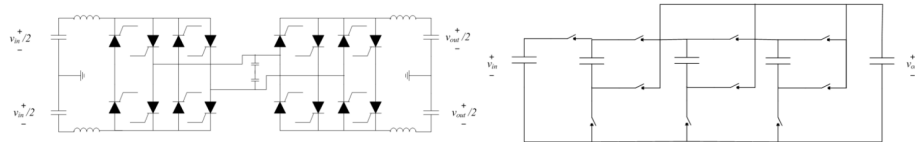

Figure 5: Non-isolated DC-DC converters¹³⁶
left: Bidirectional high-power DC transformer¹³⁷; right: Modular multi-level capacitor-clamped DC-DC converter¹³⁸

Classical DC-DC converter configurations such as buck, boost, cuk are not suitable for high power applications since they require large duty cycles at higher conversion ratio which lead to low efficiency and reliability. There are some proposals in the literature, for example a switched capacitor multilevel DC-DC converter has been proposed by Zhang et. al.¹³⁹ and Vrana et. al.¹⁴⁰ A main limitation lies in terms of lack of bidirectional power and modularity.^{141,142} Modular multilevel capacitor clamped converters are proposed by Vrana et. al.¹⁴³ and Khan & Tolbert¹⁴⁴ Although modular multilevel capacitor clamped converter has advantage of modular design, bidirectional and high frequency operation and low current ripple at input and output; but it has major drawback in terms of unequal voltage stress at the switches.^{145,146} Anot-

134. Til Kristian Vrana and Raymundo E Torres Olguin, "Technology perspectives of the North Sea Offshore and storage Network (NSON)," 2015,

135. Abdelrahman Hagar, "A new family of transformerless modular DC-DC converters for high power applications" (PhD diss., University of Toronto, 2011).

136. Til Kristian Vrana and Raymundo E Torres Olguin, "Technology perspectives of the North Sea Offshore and storage Network (NSON)," 2015,

137. Dragan Jovcic, "Bidirectional, high-power DC transformer," *IEEE transactions on Power Delivery* 24, no. 4 (2009): 2276–2283.

138. Faisal H Khan and Leon M Tolbert, "A multilevel modular capacitor-clamped DC–DC converter," *IEEE Transactions on Industry Applications* 43, no. 6 (2007): 1628–1638.

139. Fan Zhang et al., "A new design method for high-power high-efficiency switched-capacitor DC–DC converters," *IEEE Transactions on Power Electronics* 23, no. 2 (2008): 832–840.

140. Til Kristian Vrana and Raymundo E Torres Olguin, "Technology perspectives of the North Sea Offshore and storage Network (NSON)," 2015,

141. Abdelrahman Hagar, "A new family of transformerless modular DC-DC converters for high power applications" (PhD diss., University of Toronto, 2011).

142. Til Kristian Vrana and Raymundo E Torres Olguin, "Technology perspectives of the North Sea Offshore and storage Network (NSON)," 2015,

143. Ibid.

144. Faisal H Khan and Leon M Tolbert, "A multilevel modular capacitor-clamped DC–DC converter," *IEEE Transactions on Industry Applications* 43, no. 6 (2007): 1628–1638.

145. Abdelrahman Hagar, "A new family of transformerless modular DC-DC converters for high power applications" (PhD diss., University of Toronto, 2011).

146. Til Kristian Vrana and Raymundo E Torres Olguin, "Technology perspectives of the North Sea Off-

her interesting topology is soft-switched transformer-less topologies using thyristors. However, expensive large resonant capacitor is needed for this kind of technology.¹⁴⁷

6.2 Technical feasibilities

N/A

6.3 Stages of Development

Distant future

6.4 Cost and Lifetime

- Capex: N/A
- Opex: N/A
- lifetime: N/A

shore and storage Network (NSON),” 2015,

147. Til Kristian Vrana and Raymundo E Torres Olguin, “Technology perspectives of the North Sea Offshore and storage Network (NSON),” 2015,

7 Filters

Large OWPPs consist many non-linear devices such as power electronic devices in wind turbines, FACTS devices and/or HVDC transmission and other passive components such as cable arrays, transformers, transmission cables etc. Consequently, there are many harmonic generation sources.¹⁴⁸ Bradt et. al.¹⁴⁹ summarize the most important issues with respect to harmonics and resonances within wind power plants.

Primarily there are two ways to mitigate harmonics in WPPs: (i) avoiding harmonic resonance and emission by appropriate design (ii) use of harmonic filters. A good design can avoid high levels of harmonic voltages or currents through system layout, component selection and tuning of controller parameters. Both passive and active harmonic filtering can be used for harmonic mitigation. Passive filter technology is the state-of-the-art technology. Passive filter requires extensive system knowledge during the WPP design, which is very complex process since, there are many uncertainties involved in this process.

Although active and hybrid filters have been commonly used for harmonic filtering in many other industrial applications, however they have not been so common practice in WPP applications. Passive filters are more common for WT level and on the system level, e.g. point of common coupling (PCC). A major challenge for passive filter is that resonance can occur due to natural frequency matching with line impedance. Active filters have recently being introduced more and more for WTs as well, with the development of semiconductor devices and improvement of current control strategies.

7.1 Passive Filter

7.1.1 Description

Passive filters consist of a bank of tuned LC filters and/or low-pass/high-pass filter. They have been very popular owing to low initial cost and high efficiency. They have following disadvantages:¹⁵⁰

- Filtering is strongly dependent on source impedance.
- Harmonic currents on the source side can drastically increase at certain frequencies owing to parallel resonance between source and passive filter.
- Similarly, excessive harmonic currents can flow into the passive filter due to series resonance with source impedance.¹⁵¹

148. Vladislav Akhmatov, Jørgen Nygaard Nielsen, Jan Thisted, et al., “Siemens Wind Power 3.6 MW wind turbines for large offshore wind farms,” in *Proc. 7th International Workshop on Large Scale Integration of Wind Power and on Transmission Networks for Offshore Wind Farms* (Energynautics GmbH, 2008), 494–497.

149. M Bradt et al., “Harmonics and resonance issues in wind power plants,” in *Transmission and Distribution Conference and Exposition (T&D), 2012 IEEE PES* (IEEE, 2012), 1–8.

150. Hideaki Fujita and Hirofumi Akagi, “A practical approach to harmonic compensation in power systems-series connection of passive and active filters,” *IEEE Transactions on industry applications* 27, no. 6 (1991): 1020–1025.

151. Hideaki Fujita and Hirofumi Akagi, “A practical approach to harmonic compensation in power

7.1.2 Technical feasibilities

- Voltage : 550 kV¹⁵²
- Power : >3 Mvar¹⁵³

7.1.3 Stages of Development

Mature

7.1.4 Cost and Lifetime

- Capex: N/A
- Opex: N/A
- lifetime: N/A

7.2 Active Filter

7.2.1 Description

With improvement of technology and reducing costs of semiconductor switching devices such as GTO, thyristors and IGBT, active filters are becoming more practical choice for harmonics mitigation. They consist of voltage-source or current-source PWM inverters and have the ability to overcome the inherent disadvantages in passive filters.^{154, 155}

Active dc filter of an HVDC Transmission was first demonstrated by a test installation in 1991 at Lindome station of the Konti-Skan HVDC link. First commercial active dc filter was installed in 1993 at the Skagerrak 3 HVDC Intertie which was followed by Baltic Cable HVDC Link in 1994, Chandrapur-Padghe HVDC Power Transmission in 1998, "Tiang-Guang Long Distance HVDC Project" in 2000 and at the "EGAT-TNB HVDC Interconnection" in 2001.¹⁵⁶

Active DC filter is basically a hybrid filter which consists of mainly two parts: a passive part and an active part. The passive part generally comprises of a double tuned passive filter which connects the active part with the DC line.¹⁵⁷ The active part consists of the following as shown in Figure 6:¹⁵⁸

systems-series connection of passive and active filters," *IEEE Transactions on industry applications* 27, no. 6 (1991): 1020–1025.

152. ABB, *Harmonic filters CHARM*, <http://new.abb.com/high-voltage/capacitors/hv/harmonic-filters>.

153. Ibid.

154. Bhim Singh, Kamal Al-Haddad, and Ambrish Chandra, "A review of active filters for power quality improvement," *IEEE transactions on industrial electronics* 46, no. 5 (1999): 960–971.

155. Hideaki Fujita and Hirofumi Akagi, "A practical approach to harmonic compensation in power systems-series connection of passive and active filters," *IEEE Transactions on industry applications* 27, no. 6 (1991): 1020–1025.

156. Stefan Gunnarsson, Lin Jiang, and Anders Petersson, "Active filters in HVDC transmissions," in *Proceedings of the 40th Session Regular Meeting of the CIGRÉ Study Committee B4–HVDC and Power Electronics Equipments* (2009).

157. CIGRE Brochure, *Active Filters in HVDC Applications*, 2003.

158. Ibid.

- Current transducer: The main function of the current transducer is to measure current
- Control system: The control system circuitry has the main function to control the active DC filter to create virtually a low impedance path between the pole and electrode lines (or ground, depending on the configuration of the system) at the chosen harmonic frequencies.
- Amplifier: To amplify the control signal voltage in the range of 300 to 1000 V
- Transformer: To increase the amplified voltage further above 3 kV
- Protection Circuit and arrester: The protection circuit protects the amplifier by limiting the currents and voltages.
- Bypass switch and disconnectors: Bypass switch and disconnectors allows to repair and maintain the active part without taking the HVDC link out of operation.

The active part in the DC filter is defined as the components within the box shown in Figure 6 .¹⁵⁹

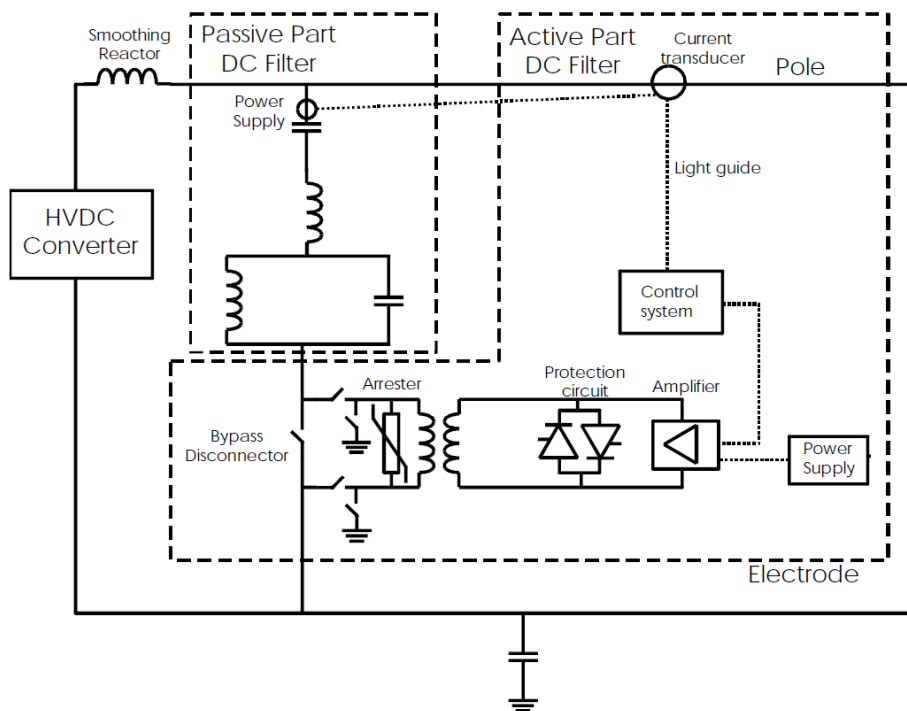

Figure 6: Filter components in the active filter¹⁶⁰

159. CIGRE Brochure, *Active Filters in HVDC Applications*, 2003.

160. CIGRE Brochure, *Active Filters in HVDC Applications*, 2003.

7.2.2 Technical feasibilities

- Active DC filter
 - Voltage : 500 kV (Chandrapur-Padghe HVDC power transmission project), 450 kV (Baltic Cable HVDC Link)
 - Filtering frequency range : 350-2500 Hz (Chandrapur-Padghe HVDC power transmission project), 300-3000 Hz (Baltic Cable HVDC Link)

7.2.3 Stages of Development

Mature

7.2.4 Cost and Lifetime

- Capex: N/A
- Opex: N/A
- lifetime: N/A

8 Reactive Compensation

Reactive power compensation in power systems can be categorized either as shunt compensation or series compensation.

8.1 Shunt Compensation

8.1.1 Description

Power transmission capacity can be increased and the voltage profile along the line can be controlled by reactive shunt compensation.¹⁶¹ Shunt reactors are applied to minimize line overvoltage due to capacitive effect of the line under light load conditions and shunt capacitors are applied to maintain voltage levels under heavy load conditions by minimizing the inductive effect of the line.¹⁶²

Static Var Compensator (SVC) and Static Synchronous Compensator (STATCOM) are variable static reactive power (called as var) generators, whose output is varied to maintain the voltage as per the requirement of power systems. A static (var) generator of controlled reactive impedance type is made of thyristor-controlled and switched reactors and capacitors. A synchronous voltage source var Compensator employs a switching power converter, while a hybrid type can employ a combination of these elements. The operating principles of all these var generators are different from each other with varying V-I characteristics, loss vs. var output characteristics, speed of response, attainable frequency bandwidth, etc. However, their functionality is similar in providing the controllable reactive shunt compensation within their linear operating range.

8.1.2 Technical feasibilities

- SVC
 - Voltage (line to ground) for converters : 765 kV (Voltage depending on interfacing power transformers)¹⁶³
 - Dynamic Reactive power : -300/+600 MVar (Based on need from grid studies)¹⁶⁴
 - Current : 4-5 kA per branch¹⁶⁵
 - losses per converter station : 1.5-2 % of the rated power¹⁶⁶

- STATCOM

161. Yong-Hua Song and Allan Johns, *Flexible ac transmission systems (FACTS)*, 30 (IET, 1999).

162. Narain G Hingorani and Laszlo Gyugyi, *Understanding FACTS* (IEEE press, 2000).

163. Grid Innovation Online, *Technology Database*, <http://www.gridinnovation-on-line.eu/Technology-Database>.

164. Ibid.

165. Ibid.

166. Ibid.

- Voltage (line to ground) for converters : 765 kV (Voltage depending on interfacing power transformers)¹⁶⁷
- Dynamic Reactive power : -200/+200 MVar (Depending on need from grid studies; can be offset by a combined solution with fixed capacitor banks or thyristor controlled capacitor banks)¹⁶⁸
- Current : 2-3 kA per branch¹⁶⁹
- losses per converter station : 1.5-2 % of the rated power¹⁷⁰

8.1.3 Stages of Development

Mature

8.1.4 Cost and Lifetime

- SVC
 - Capex : 30-50 k€/MVAR (Average investment cost ranges for a SVC at 2013, rating: 100-850 MVAR/MVA; 400 kV)¹⁷¹
 - Opex: N/A
 - Lifetime : 40 years¹⁷²
- STATCOM
 - Capex : 50-75 k€/MVAR (Average investment cost ranges for a STAT-COM at 2013, rating: 100-400 MVAR/MVA; 400 kV)¹⁷³
 - Opex: N/A
 - Lifetime : 40 years¹⁷⁴

8.2 Series Compensation

8.2.1 Description

The main purpose of shunt compensation as mentioned in the previous subsection is to maintain the desired voltage profile along the transmission line and providing support to the end voltage of radial lines in the face of increasing power demand.¹⁷⁵ However, shunt compensation is not controllable in order to control the actual transmitted power through a transmission line which is ultimately determined by the series line impedance and the angle between the end voltages of line.¹⁷⁶

167. Grid Innovation Online, *Technology Database*, <http://www.gridinnovation-on-line.eu/Technology-Database>.

168. Ibid.

169. Ibid.

170. Ibid.

171. Ibid.

172. Ibid.

173. Ibid.

174. Ibid.

175. Narain G Hingorani and Laszlo Gyugyi, *Understanding FACTS* (IEEE press, 2000).

176. Ibid.

Power transmitted over a long transmission line is limited by the series reactive impedance of the line. Series capacitive compensation can be introduced in the line to cancel a portion of the reactive line impedance and thereby increase the transmittable power. Within this functionality, variable series compensation is highly effective in both controlling power flow in the line and in improving grid stability.¹⁷⁷

Fixed Series Capacitor and Thyristor Controlled Series Compensation (TCSC) are most commonly used technology for series compensation.

8.2.2 Technical feasibilities

- Fixed Series Capacitor
 - Voltage (line to ground) for converters : 765 kV¹⁷⁸
 - Rated Reactive Power : 1350 MVAR¹⁷⁹
 - losses : negligible¹⁸⁰
- TCSC
 - System voltage: 400-550 kV¹⁸¹
 - Rated continuous current: 1500 A¹⁸²
 - Rated overall power: 493 Mvar
 - Degree of compensation:
 - * Total: 70 %
 - * Thyristor controlled: 21 %

8.2.3 Stages of Development

Mature

8.2.4 Cost and Lifetime

- Fixed Series Capacitor
 - Capex : 10-20 k€/MVAR (Average investment cost ranges for a FSC at 2013, rating: 100-1000 MVAR/MVA; 400 kV)¹⁸³
 - Opex: N/A

177. Narain G Hingorani and Laszlo Gyugyi, *Understanding FACTS* (IEEE press, 2000).

178. Grid Innovation Online, *Technology Database*, <http://www.gridinnovation-on-line.eu/Technology-Database>.

179. Ibid.

180. Ibid.

181. IRENE-40.eu, *IRENE-40 Technology Database*, <http://database.irene40.eu/>.

182. ABB, *Thyristor controlled series compensation*, <http://new.abb.com/facts/thyristor-controlled-series-compensation>.

183. Grid Innovation Online, *Technology Database*, <http://www.gridinnovation-on-line.eu/Technology-Database>.

- Lifetime : 40 years¹⁸⁴

- TCSC

- Capex : N/A

- Opex: N/A

- Lifetime : N/A

184. Grid Innovation Online, *Technology Database*, <http://www.gridinnovation-on-line.eu/Technology-Database>.

9 Transformers

9.1 Description

Transformer technology has been invented more than hundred years ago but the basic operating, physical and design principles of transformers are quite the same even today. Although the technology has improved significantly resulting in increased efficiency, higher power rating, reduced weight, decreased dimensions, and reducing costs. Traditionally, the loads are located at farther distance away from the generation plants. Therefore, voltage needs to be increased substantially to transmit large volume of power over long distances.

The main purpose of transformer is to increase the output voltage resulting in reduced losses, increased transmission capacity, reduced copper/aluminium requirements etc. Transformers are very widely used in AC power system and design of transformer depends on application, operating voltage level and rated power. Transformers can be broadly categorized into 2 groups based on their application in power transmission and distribution:

- Power transformer for transmitting power over long distances at high voltages
- Distribution transformer for distributing power to consumers at medium and low voltage levels

Mainly power transformers are considered in this section based on the scope of this catalogue. Depending on applications power transformers can be further categorized into many types such as Generator step-up (GSU) transformer, Step-down transformer, HVDC Converter transformer, Phase shifting transformer (PST), System inertie transformer etc.

Generator step-up (GSU) transformers, as name suggests, are installed in generating substations and used to increase the voltages in order to transmit over long distances. These kind of transformers are generally operated at full load day and night.¹⁸⁵ As discussed in previous section that HVDC technology is cost-effective and more efficient to transmit large volume of power over large distances. System inertie transformers are generally equipped with on-load-tap changers (OLTC) and used to reduce the incoming transmission high voltages to medium voltages.¹⁸⁶ HVDC converter transformer connects AC grid and high power converter making the voltage suitable for the converter. It also acts as isolator for the converter from grid faults.^{187, 188}

Highest transmission voltage for HVDC has been constantly increasing. For example, ABB has developed Ultra-High Voltage Direct Current converter transformer of

185. ABB, *Generator step-up transformers (GSU)*, <http://new.abb.com/products/transformers/power/generator-step-up>.

186. ABB, *System inertie transformers*, <http://new.abb.com/products/transformers/power/system-intertie-transformers>.

187. ABB, *HVDC converter transformers*, <http://new.abb.com/products/transformers/power/hvdc-converter>.

188. SIEMENS, *HVDC Transformers*, <https://www.energy.siemens.com/hq/en/power-transmission/transformers/hvdc-transformers/hvdc-transformers.htm#content=Description>.

voltage rating of 1100 kV that allows the HVDC to transmit power up to 10000 MW over distances as long as 3000 km.¹⁸⁹

9.2 Technical feasibilities

- Voltage (line to ground): 765 kV (Typical up to 400kV. 765kV technically possible.)¹⁹⁰
- Current: 10 kA (Not a limiting factor in power systems. Design of short circuit currents up to 40kA available.)¹⁹¹
- Max Power per unit: Technical capability - 1630 MVA¹⁹²
Please note that maximum power (or current) is not a limiting factor, rather transport capability of the cable dictates the size of the transformer.
A typical 765 kV transformers have power rating close to 800 MVA.
- Losses per unit: 0.2-0.4% of rated power¹⁹³

9.3 Stages of Development

Mature

9.4 Cost and Lifetime

- Capex: 60 M€¹⁹⁴
- Opex: N/A
- lifetime: 40 years

189. e-Highway2050, D3.2 - *Technology innovation needs*, http://www.e-highway2050.eu/fileadmin/documents/Results/D3.2_Technology_innovation_needs_20151202.pdf, 2015.

190. Grid Innovation Online, *Technology Database*, <http://www.gridinnovation-on-line.eu/Technology-Database>.

191. Ibid.

192. Ibid.

193. Ibid.

194. Ioannis Konstantelos et al., "Integrated North Sea grids: The costs, the benefits and their distribution between countries," *Energy Policy* 101 (2017): 28–41.

10 Offshore Substructures

10.1 Description

Offshore substructures and foundation technology which lies below the water level is chosen based on multiple site conditions and platform properties. The most relevant site conditions are water depth, wave heights/transparency, sensitivity to the soil and water currents. The main relevant platform properties are size and vertical/horizontal weight.¹⁹⁵ Selection is based on structural analysis and cost-benefit analysis.

Although the substructures can be classified based on many criteria, they are classified into six basic types in this report and shown in Figure 7.

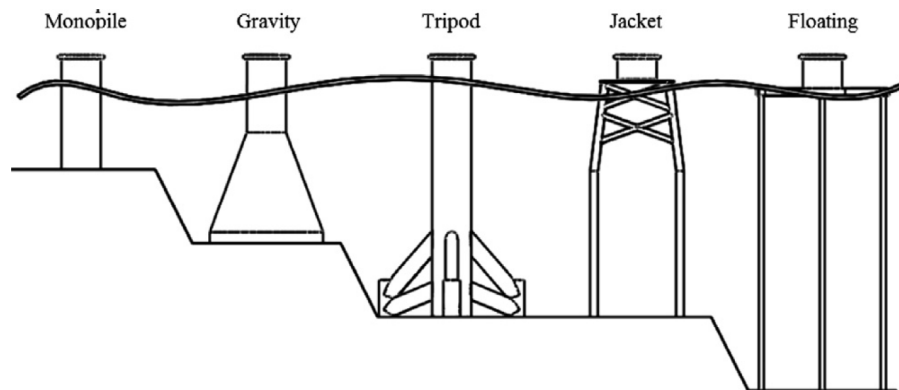

Figure 7: Offshore wind turbine foundations¹⁹⁶

- Monopiles
- Tripods
- Tripiles
- Jackets
- Gravity foundations
- Floating foundations

Figure 8 shows the share of substructures for offshore wind farms based on data until end of 2012.¹⁹⁷ It can be seen that monopile substructures constitute most of the proportion. However, monopiles are more favoured technology for shallow water with

195. Til Kristian Vrana and Raymundo E Torres Olguin, "Technology perspectives of the North Sea Offshore and storage Network (NSON)," 2015.

196. Paraic Higgins and Aoife Foley, "The evolution of offshore wind power in the United Kingdom," *Renewable and sustainable energy reviews* 37 (2014): 599–612.

197. European Wind Energy Association(EWEA), *Deep water: the next step for offshore wind energy*, http://www.ewea.org/fileadmin/files/library/publications/reports/Deep_Water.pdf, 2013.

typical water depth less than 30 m. As can be seen from Figure 9,¹⁹⁸ all the online wind farms in this considered dataset belongs to offshore locations with water depth less than 30 m. As wind farms are moving far offshore and deeper waters, other technologies such as gravity, jacket and floating foundations are becoming more relevant.

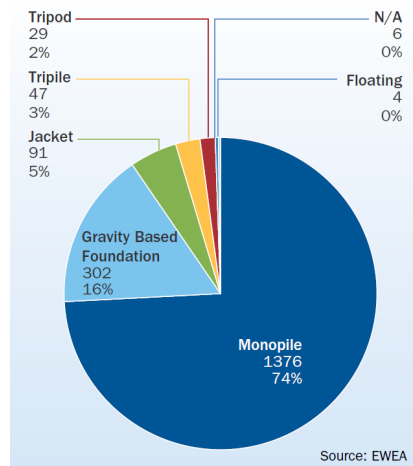

Figure 8: Share of substructures for online offshore wind farms based on data until end of 2012¹⁹⁹

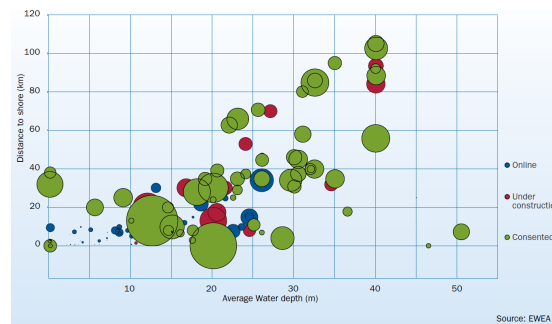

Figure 9: Water depth vs. distance to shore for offshore wind farms based on data until end of 2012²⁰⁰

198. European Wind Energy Association(EWEA), *Deep water. the next step for offshore wind energy*, http://www.ewea.org/fileadmin/files/library/publications/reports/Deep_Water.pdf, 2013.

199. European Wind Energy Association(EWEA), *Deep water. the next step for offshore wind energy*, http://www.ewea.org/fileadmin/files/library/publications/reports/Deep_Water.pdf, 2013.

200. European Wind Energy Association(EWEA), *Deep water. the next step for offshore wind energy*, http://www.ewea.org/fileadmin/files/library/publications/reports/Deep_Water.pdf, 2013.

10.1.1 Monopile Substructures

Monopile substructures comprise for most of all substructures of the European operating wind farms.²⁰¹ The monopile needs to be drilled down into the seabed.²⁰² Monopiles are easy to install in shallow to medium water depths. This type of structure is well suited for sites with water depth ranging from 0-35m.²⁰³ Advantages of monopile foundation lies in its simplicity, light weight and versatility. However, it can be expensive for large size installations such as for converter substation platform. Decisions on monopiles should be made on cost-benefit analysis. This type of installation is also difficult to remove.^{204,205} Recently, monopiles with bigger diameter called XXL monopiles are being considered as viable alternative to jacket substructures for deeper water installations.²⁰⁶ World's heaviest monopile of 7.8 m of diameter and weight of 1302.5 t is used in Veja Mate offshore wind farm.²⁰⁷ Research is even ongoing for applying monopile technology to as deep as 50 m.²⁰⁸

10.1.2 Tripod Substructures

The tripod structure is standard lightweight three-legged structure made of cylindrical steel tubes. It consists of a central steel column between the turbine and a steel frame. This central shaft transfers the forces from the tower into three vertical or inclined steel piles. These piles are driven 10-20m into the seabed.²⁰⁹ In order to make it suitable for actual environmental and soil conditions, base width and pile penetration depth of this substructure can be adjusted. This type of structure is generally suitable for water depth of 20-50 m. This type of substructure has good stability and overall stiffness.^{210,211}

This type of structure are suitable for most conditions but deep soft material. It is quite rigid and versatile. However, this type of construction and installation are

201. C Wolter et al., "Overplanting in offshore wind power plants in different regulatory regimes," in *proc. 15th International Workshop on large scale integration of wind power into power systems* (2016).

202. Mark J Kaiser and Brian F Snyder, "Offshore Wind Energy System Components," in *Offshore Wind Energy Cost Modeling* (Springer, 2012), 13–30.

203. Y (Ed.) Garbatov and C (Ed.) Guedes Soares, *Progress in the Analysis and Design of Marine Structures* (CRC Press, London, 2017).

204. *Monopiles Support Structures*, <http://www.4coffshore.com/windfarms/monopiles-support-structures-aid4.html>.

205. International Renewable Energy Agency(Irena), *Renewable energy technologies: Cost analysis series*, https://www.irena.org/DocumentDownloads/Publications/RE_Technologies_Cost_Analysis-WIND_POWER.pdf, 2012.

206. Vicente Negro et al., "Monopiles in offshore wind: Preliminary estimate of main dimensions," *Ocean Engineering* 133 (2017): 253–261.

207. Offshore Wind Industry, *EEW has produced the world's heaviest Monopile*, <http://www.offshorewindindustry.com/news/eew-produced-worlds-heaviest-monopile>.

208. Njomo Wandji Wilfried, Anand Natarajan, and Nikolay Dimitrov, "Influence of model parameters on the design of large diameter monopiles for multi megawatt offshore wind turbines at 50 m water depths," *Wind Energy*, 2018,

209. L Chen, WH Lam, and AH Shamsuddin, "Potential scour for marine current turbines based on experience of offshore wind turbine," in *IOP Conference Series: Earth and Environmental Science*, vol. 16, 1 (IOP Publishing, 2013), 012057.

210. *Tripod Support Structures*, <http://www.4coffshore.com/windfarms/tripod-support-structures-aid7.html>.

211. DNV, *Design of Offshore Wind Turbine Structures*, <https://rules.dnvgl.com/docs/pdf/DNV/codes/docs/2014-05/0s-J101.pdf>, 2014.

expensive and difficult to remove.²¹²

10.1.3 Tripile Substructures

The tripile structure is also called jacket-monopile hybrid structure. As name suggests, this kind of structure has a three-legged jacket structure in the lower section which is then connected to a monopile in the upper part of the water column (made of cylindrical steel tubes). In order to make it suitable for actual soil conditions, base width and pile penetration depth of the tripile substructures can be adjusted. This type of structure is generally suitable for water depth of 20-50 m.^{213,214}

This type of technology has been used at BARD Offshore 1 wind farm.²¹⁵

10.1.4 Jacket Substructures

Jacket substructures are made of a truss frame which consists of many tubular members welded together. In order to secure the structure from lateral forces, piling is driven through each leg of the jacket into the seabed (or through skirt piles at the bottom of the foundation).²¹⁶

Jacket foundations have been applied to wind turbines in the Alpha Ventus offshore wind farm and for converter platform in 400 MW BorWin1 converter which weighs 3200 tons.

10.1.5 Gravity substructures

Gravity based structures are made of concrete structures (often filled with gravel, sand, iron ore and/or stones to increase weight and stability) which can be constructed with or without small steel or concrete skirts. This type of structure uses its weight to resist wind and wave loading. In order to make it suitable for actual soil conditions, base width can be adjusted.²¹⁷

Concrete gravity based structures are virtually suitable for all soil conditions. It has advantage of allowing float-out installation. It can be expensive because of weight.²¹⁸

Steel gravity based structures are virtually suitable for all soil conditions but preferable for deeper water than concrete based. It has advantage of being lighter than concrete based which also allows easier transportation and installation. However, it

212. International Renewable Energy Agency(Irena), *Renewable energy technologies: Cost analysis series*, https://www.irena.org/DocumentDownloads/Publications/RE_Technologies_Cost_Analysis-WIND_POWER.pdf, 2012.

213. DNV, *Design of Offshore Wind Turbine Structures*, <https://rules.dnvgl.com/docs/pdf/DNV/codes/docs/2014-05/0s-J101.pdf>, 2014.

214. *Tripile Support Structures*, <http://www.4coffshore.com/windfarms/tripile-support-structures-aid6.html>.

215. Ibid.

216. Mark J Kaiser and Brian F Snyder, "Offshore Wind Energy System Components," in *Offshore Wind Energy Cost Modeling* (Springer, 2012), 13–30.

217. DNV, *Design of Offshore Wind Turbine Structures*, <https://rules.dnvgl.com/docs/pdf/DNV/codes/docs/2014-05/0s-J101.pdf>, 2014.

218. International Renewable Energy Agency(Irena), *Renewable energy technologies: Cost analysis series*, https://www.irena.org/DocumentDownloads/Publications/RE_Technologies_Cost_Analysis-WIND_POWER.pdf, 2012.

can be expensive in an erosion prone region mainly because of additional requirement of cathodic protection system.²¹⁹

10.1.6 Floating Substructures

Since the cost of all bottom-fixed foundations increases more than linear with water depth, floating foundation can be a better choice than bottom-fixed foundations at deep waters.²²⁰ The break-even-point of water depth is unclear yet, mostly due to limited experience with floating foundations. It has some degrees of freedom for movement, but it is held in place by an anchoring system.

When considering floating foundations for electrical installations, one important restriction has to be regarded: Floating electrical installations usually cannot be connected to MI-type power cables, as those are not flexible enough to cope with the movements of floating structures.²²¹

It has the advantage of inexpensive foundation construction. Further, the structure being non-rigid, it is susceptible to lower wave loads. However, disadvantage of this type of foundation lies in higher mooring and platform cost. Also, this kind of foundation excludes fishing and navigation from areas of wind farm.²²²

10.2 Technical feasibilities

- Monopile Foundation
 - Sea Depth : 0 - 30 m²²³ Mega(XXL) monopiles: upto 45-50 m²²⁴
- Tripod Foundations
 - Sea Depth : > 6-7 m²²⁵ (Typically 20-50 m)
- Tripile Foundations
 - Sea Depth : 25-40 m²²⁶
- Jacket Foundation

219. International Renewable Energy Agency(Irena), *Renewable energy technologies: Cost analysis series*, https://www.irena.org/DocumentDownloads/Publications/RE_Technologies_Cost_Analysis-WIND_POWER.pdf, 2012.

220. Til Kristian Vrana and Raymundo E Torres Olguin, "Technology perspectives of the North Sea Offshore and storage Network (NSON)," 2015,

221. Ibid.

222. International Renewable Energy Agency(Irena), *Renewable energy technologies: Cost analysis series*, https://www.irena.org/DocumentDownloads/Publications/RE_Technologies_Cost_Analysis-WIND_POWER.pdf, 2012.

223. *Monopiles Support Structures*, <http://www.4coffshore.com/windfarms/monopiles-support-structures-aid4.html>.

224. *Steelwind Nordenham*, <http://www.steelwind-nordenham.de/steelwind/produkte/megamonopiles/index.shtml.en>.

225. *Tripod Support Structures*, <http://www.4coffshore.com/windfarms/tripod-support-structures-aid7.html>.

226. *Tripile Support Structures*, <http://www.4coffshore.com/windfarms/tripile-support-structures-aid6.html>.

- Sea Depth : 20-50 m²²⁷
- Gravity Foundation
 - Sea Depth : 0-25 m²²⁸
- Floating Foundation
 - Sea Depth : <40 m²²⁹

10.3 Stages of Development

- Monopile Foundation
 - Mature
- Tripod Foundation
 - Mature
- Tripile Foundation
 - Mature
- Jacket Foundation
 - Mature
- Gravity Foundation
 - Mature
- Floating Foundation
 - Young/Shortly Coming

A pilot turbine called Hywind was placed in waters off Norway in 2009. The foundation consists of an 8.3 m diameter, 100 m long submerged cylinder secured to the seabed by three mooring cables. Another pilot project in the wind industry is Blue H which consists of a two blade turbine placed on top of a buoyant, semi-submerged steel structure attached to a counterweight on the seabed.²³⁰

227. M Esteban et al., “Foundations for offshore wind farms,” in *Proceedings of the 12th International Conference on Environmental Science and Technology, Rhodes, Greece* (2011), 516–523.

228. Ibid.

229. Ibid.

230. Mark J Kaiser and Brian F Snyder, “Offshore Wind Energy System Components,” in *Offshore Wind Energy Cost Modeling* (Springer, 2012), 13–30.

10.4 Cost and Lifetime

- Wind Turbine Platform

- Capex: Cost depends on water depth, environment and soil condition. Figure 10 shows Monopiles and Jacket foundation costs expressed for different water depths.

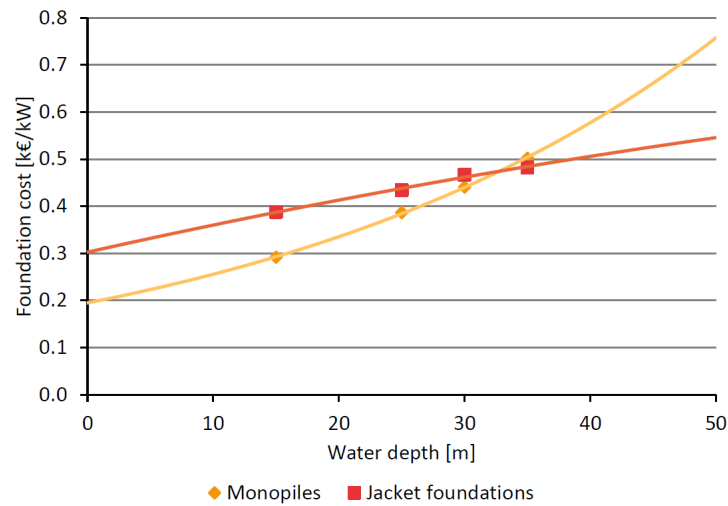

Figure 10: Monopile and jacket foundation costs for an 8 MW Wind Turbine²³¹

- Converter Platform

- Capex: N/A
- Opex: N/A
- lifetime: N/A

²³¹ C Wolter et al., “Overplanting in offshore wind power plants in different regulatory regimes,” in *proc. 15th International Workshop on large scale integration of wind power into power systems* (2016).

11 Protection Equipment

11.1 AC Circuit Breaker

11.1.1 Description

Circuit breakers are the central part of air-insulated (AIS) and gas-insulated (GIS) switchgear which are used to disconnect feeders when faults are detected. High-voltage circuit breakers are mechanical switching devices which carry the nominal current in closed position and break current circuits (operating currents and fault currents).²³²

High-voltage breakers can be categorized based on the medium used to extinguish the arc as follows:

- Bulk oil
- Minimum oil
- Air blast
- Vacuum
- SF6
- CO2

Due to environmental and cost concerns over insulating oil spills, SF6 based circuit breakers are mostly used in recent times.²³³ High-voltage AC circuit breakers are routinely available with ratings up to 765 kV.²³⁴ 1200 kV breakers were launched by Siemens in November 2011, followed by ABB in April the following year.

11.1.2 Technical feasibilities

- Voltage (line to ground): upto 800kV (Typical up to 400kV. 800kV technically possible.)²³⁵
- Current: 80 kA²³⁶
- Reliability (per unit): >99.9%²³⁷
- Losses per unit: ≈ 0 ²³⁸

232. Siemens, *Circuit Breakers*, <https://www.energy.siemens.com/us/en/power-transmission/high-voltage-products/circuit-breaker/sf6-hv-circuitbreaker-dtc.htm>.

233. Yoshihiko Matsui et al., "Development and technology of high voltage VCBs; Brief history and state of art," in *Discharges and Electrical Insulation in Vacuum, 2006. ISDEIV'06. International Symposium on*, vol. 1 (IEEE, 2006), 253–256.

234. Mohd Hasan Ali, *Wind energy systems: solutions for power quality and stabilization* (CRC Press, 2012).

235. Grid Innovation Online, *Technology Database*, <http://www.gridinnovation-on-line.eu/Technology-Database>.

236. Ibid.

237. Ibid.

238. Ibid.

11.1.3 Stages of Development

Mature

11.1.4 Cost and Lifetime

- Capex: N/A
- Opex: N/A
- lifetime: 8000-10000 operations per unit

11.2 DC Circuit Breaker

11.2.1 Description

In future HVDC grids, DC breakers will be needed to isolate faulty parts of the grid during earth faults whereas, other kinds of faults can be handled by converters or slower DC switches depending on the fault. Generally, DC breakers require to quench fault currents with very fast rising times since DC circuits operate without a natural zero crossing current as compared to AC circuits.

Electronic breakers are capable of operating very fast but have relatively high on-state losses. While a hybrid DC breaker has a mechanical bypass path to reduce the losses to near zero (60 kW at 320 kV DC) while maintaining clearance time.²³⁹

Power electronic based DC breakers consists of only semiconductor-based switches. When switches are turned off to break the current, the magnetic energy stored in inductance within the circuit, oppose sudden change in current, resulting in commutating the current into a means of energy dissipation.²⁴⁰

The advantages of power electronic HVDC circuit breakers are as follows:²⁴¹

- Fast operation
- Low maintenance due to absence of moving parts
- Modular design
- Increased redundancy
- Almost no limitation on number of operations
- Fast reclose
- Requirement for series inductance can be reduced due to faster response
- Lower current turn-off capability required for semiconductor switches

239. e-Highway2050, *Technology Assessment Report (HVDC) - Annex to D3.1 - Technology Assessment Report*, http://www.e-highway2050.eu/fileadmin/documents/Results/D3/report_HVDC.pdf, 2014.

240. CIGRE Brochure, *Technical Requirements and specifications of state-of-the-art HVDC switching equipment*, 2017.

241. Ibid.

The disadvantages of power electronic HVDC circuit breakers are as follows:²⁴²

- High on-state losses
- Sensitivity of semiconductor devices
- Minimal overcurrent and overvoltage capacity
- No galvanic isolation (without additional equipment)
- Cooling requirements
- Expensive

The hybrid DC circuit breaker is a combination of mechanical and power electronic switches. Hybrid DC circuit breaker has superior steady state and dynamic performance than power electronic DC circuit breaker.

The advantages of hybrid HVDC circuit breakers are as follows:²⁴³

- Low conduction losses
- Can withstand very high currents in closed position
- Very low leakage current and can withstand high-voltage in open position

The disadvantages of hybrid HVDC circuit breakers are as follows:²⁴⁴

- Slower operation than power electronic circuit breaker
- Mechanical wear and maintenance required because of moving mechanical parts

11.2.2 Technical feasibilities

N/A

11.2.3 Stages of Development

Future

Although manufacturers like ABB and Siemens have developed and tested DC circuit breakers for HVDC applications, however there has not been any practical implementation of these technologies.^{245,246}

242. CIGRE Brochure, *Technical Requirements and specifications of state-of-the-art HVDC switching equipment*, 2017.

243. Ibid.

244. Ibid.

245. ABB, *ABB's Hybrid HVDC Circuit Breaker*, <http://new.abb.com/grid/events/cigre2014/hvdc-breaker>.

246. Siemens, *DC commutation breaker successfully tested in 5000-A HVDC system in China*, [https://www.siemens.com/press/en/pressrelease/?press=/en/pressrelease/2015/energymanagement/pr2015010107emen.htm&content\[\]=EM](https://www.siemens.com/press/en/pressrelease/?press=/en/pressrelease/2015/energymanagement/pr2015010107emen.htm&content[]=EM).

11.2.4 Cost and Lifetime

- Capex: N/A

Since there is no practical implementation till date, it is hard to estimate/assume cost of DC breakers, but it can be expected to be in the range of tens of million euros.

- Opex: N/A
- lifetime: N/A

11.3 Fault Current Limiter

11.3.1 Description

Fault current limiters (FCL) as name suggests, are devices used to limit the fault current to acceptable levels. These devices are generally applied in AC systems, but some concepts can also be used for DC systems. For AC systems, there are two general types of FCLs- Resistance based or Reactance based.²⁴⁷

The reactance based concept cannot directly be used in DC systems while resistance based concept is similar for DC and AC systems. Generally, non-linear properties are desired for FCLs, in order to have more impact on fault-operation as compared to normal operation. However, linear components can also be used for limiting the fault current.²⁴⁸

Different types of FCL are as follows:²⁴⁹

- Inductors
- Polymeric Positive Temperature Coefficient Resistor-based FCL
- Liquid Metal FCL
- Superconductive FCL

11.3.2 Technical feasibilities

- 10 MVA Key Parameters²⁵⁰
 - Line Voltage : 11kV, 50Hz, 3-ph
 - Nominal load current (power through) : 525 A rms (10MVA)
 - Prospective fault current : 5.34kA rms, 13.6kA peak
 - Limited fault current 2.22kA rms, 9.13kA peak

247. Til Kristian Vrana and Raymundo E Torres Olguin, "Technology perspectives of the North Sea Off-shore and storage Network (NSON)," 2015,

248. Ibid.

249. Ibid.

250. Pannu, Mohinder and Valent, Yoram and Garbi, Uri, "Saturated Core Fault Current Limiters: successful testing/service performance," *Transformers Magazine* 2, no. 4 (2015): 78–86.

- Fault current reduction (clipping) : 58% of steady state rms (33% of first peak)
- Tested fault withstand duration : 3 seconds
- Recovery from fault to normal load : Instantaneous (less than 1msec)
- CB reclosing : Fully tested w/ 500 msec dead zone between faults
- Voltage drop during normal operation : 0.8-2%
- Power frequency voltage withstand : 28kV
- Lightning impulse withstand : 75kV

11.3.3 Stages of Development

Mature

11.3.4 Cost and Lifetime

- Capex: N/A
- Opex: N/A
- lifetime: N/A

12 Auxiliary Equipment

12.1 Tapping equipment

12.1.1 Description

Tapping converter is connected to a point to point connection somewhere along the line or cable and used as 'tap' to supply a small load that is typically an auxiliary equipment required for operation of the system. It has much lower power rating compared to the main power rating of the HVDC scheme which it is connected to.²⁵¹

12.1.2 Technical feasibilities

N/A

12.1.3 Stages of Development

Distant future

12.1.4 Cost and Lifetime

- Capex: N/A
- Opex: N/A
- lifetime: N/A

12.2 Supervisory, control and data acquisition (SCADA)

12.2.1 Description

A vital element of the wind farm is the SCADA system. This system acts as a 'nerve centre' for the project by connecting the individual turbines, the substation and meteorological stations to a central computer for monitoring and control. The SCADA computer communicates with the turbines via optical fibre based communications network. It allows the operator to supervise the behaviour of all the wind turbines and also the wind farm as a whole. It also records energy output, availability and error signals, which can help in planning, maintenance, warranty calculations etc.²⁵² SCADA also allows to operate the wind farm in different operational modes based on network requirements such as frequency control, voltage control, power curtailment, reactive power support etc.

251. e-Highway2050, *Technology Assessment Report (HVDC) - Annex to D3.1 - Technology Assessment Report*, http://www.e-highway2050.eu/fileadmin/documents/Results/D3/report_HVDC.pdf, 2014.

252. European Wind Energy Association et al., *Wind energy-the facts: a guide to the technology, economics and future of wind power* (Routledge, 2012).

12.2.2 Technical feasibilities

Compliance with IEC 61400-25 standard for wind turbines

12.2.3 Stages of Development

Mature

12.2.4 Cost and Lifetime

- Capex: N/A
- Opex: N/A
- lifetime: N/A

13 Summary

The main components needed for the development of an offshore grid are available today. The main uncertainty, in terms of components, is the availability, cost and technical maturity of the DC breakers, which are needed in the case of a meshed grid design. However, there are ways around it, mainly by using a modular grid design, where each sub-grid is below the N-1 single outage contingency limit in the different synchronous areas.²⁵³ Nevertheless, at this point it is rather safe to assume that full scale DC breakers will be tested and operated by a time horizon of 2030.

- Table 3 summarizes the stages of development for all the technologies.
- Table 4 summarizes the costs and lifetime for all the technologies.

²⁵³ K Bell et al., *Deliverable 15.2, TWENTIES project, Technical and economic impact analysis of the demonstrations in TF2*, http://orbit.dtu.dk/fedora/objects/orbit:129857/datastreams/file_0b45a5d2-e062-489e-8cfe-2401e55e4da4/content, 2013.

Table 3: Stages of development for different components

Components	Mature	Young	Future	Distant-Future
Wind Turbines	x			
XLPE-HVAC Cables	x			
HTS-HVAC Cables	x			
XLPE-HVDC Cables	x			
MI-HVDC Cables	x			
SFF-HVDC Cables	x			
LCC converters	x			
VSC converters	x			
DRU converters			x	
DC/DC converters				x
Passive Filter	x			
Active Filter	x			
SVC	x			
STATCOM	x			
Fixed Series Capacitor	x			
TCSC	x			
Transformers	x			
Monopile Foundations	x			
Tripod Foundations	x			
Tripiles Foundations	x			
Jacket Foundations	x			
Gravity Foundation	x			
Floating Foundation		x		
AC Circuit Breaker	x			
DC Circuit Breaker			x	
Fault Current Limiter	x			
Tapping Equipment				x
SCADA	x			

Table 4: Costs and lifetime for different components

Components	CAPEX	OPEX	Lifetime
Wind Turbines	1.5k-2.5k US\$/kW	N/A	25 yrs
XLPE-HVAC Cables	3675-4062 k€/km	7.3-8.1 k€/km	N/A
HTS-HVAC Cables	N/A	N/A	N/A
XLPE-HVDC Cables	1470-1625 k€/km	2.9-3.2 k€/km	>40 yrs
MI-HVDC Cables	N/A	N/A	>40 yrs
SFF-HVDC Cables	N/A	N/A	N/A
LCC converters	101-112 M€/GW	2%	40 yrs
VSC converters	106-118 k€/MW	2%	40 yrs
DRU converters	N/A	N/A	N/A
DC/DC converters	N/A	N/A	N/A
Passive Filter	N/A	N/A	N/A
Active Filter	N/A	N/A	N/A
SVC	30-50 k€/MVAR	N/A	40 yrs
STATCOM	50-75 k€/MVAR	N/A	40 yrs
Fixed Series Capacitor	10-20 k€/MVAR	N/A	40 yrs
TCSC	N/A	N/A	N/A
Transformers	60 M€	N/A	40 yrs
Monopile Foundations	N/A	N/A	N/A
Tripod Foundations	N/A	N/A	N/A
Tripiles Foundations	N/A	N/A	N/A
Jacket Foundations	N/A	N/A	N/A
Gravity Foundation	N/A	N/A	N/A
Floating Foundation	N/A	N/A	N/A
AC Circuit Breaker	N/A	N/A	8k -10k operations
DC Circuit Breaker	N/A	N/A	N/A
Fault Current Limiter	N/A	N/A	N/A
Tapping Equipment	N/A	N/A	N/A
SCADA	N/A	N/A	N/A

Appendices

A HVDC Converter Station Configuration

There are three basic configurations of VSC based HVDC Converter Station in a HVDC grid.

- Asymmetrical monopole configuration:

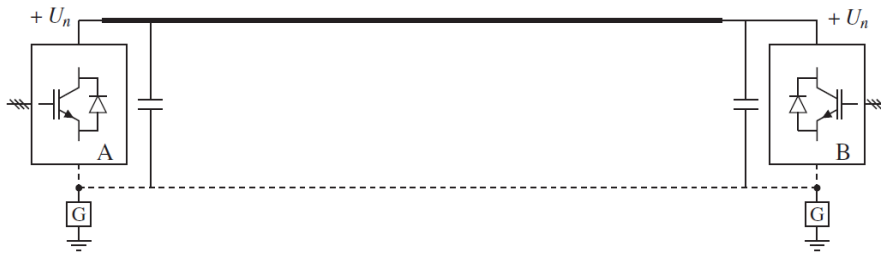

Figure 11: Asymmetrical monopolar configuration²⁵⁴

This configuration as shown in Figure 11 has only one high voltage conductor (overhead line or cable) and one grounded neutral conductor. The neutral conductor acting as metallic return, although is fully rated for the load current but only lightly insulated which makes it cheaper and more reliable. A major disadvantage of this converter is that if any of the major component of the converter is lost, either due to a fault or during maintenance, complete disruption of power transfer through this converter is needed.²⁵⁵

- Symmetrical monopole configuration



Figure 12: Symmetrical monopolar configuration²⁵⁶

254. Willem Leterme et al., "Overview of grounding and configuration options for meshed HVDC grids," *IEEE Transactions on Power Delivery* 29, no. 6 (2014): 2467–2475.

255. Dirk Van Hertem, Oriol Gomis-Bellmunt, and Jun Liang, *HVDC grids: for offshore and supergrid of the future*, vol. 51 (John Wiley & Sons, 2016).

256. Willem Leterme et al., "Overview of grounding and configuration options for meshed HVDC grids," *IEEE Transactions on Power Delivery* 29, no. 6 (2014): 2467–2475.

Figure 12 shows the configuration of a symmetrical monopole. As opposing to the asymmetrical monopole, the AC connection is made to the midpoint of the VSC converter. This type of configuration requires two fully rated high-voltage conductors. Two DC terminals are connected to the positive and negative pole of the converters operating at equal and opposite DC voltage. A major disadvantage of this configuration is that if any of the major component of the configuration is lost, either due to a fault or during maintenance, complete disruption of power transfer through this converter is needed. Symmetrical monopoles have been widely used configuration.²⁵⁷

- Bipolar configuration

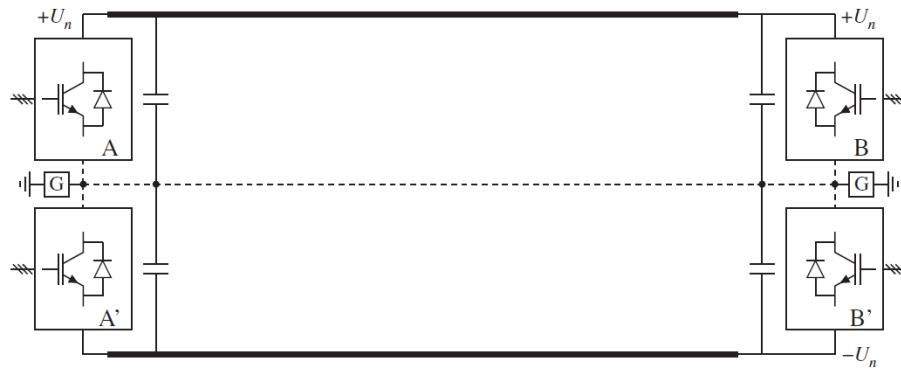

Figure 13: Bipolar configuration²⁵⁸

Figure 13 shows schematic diagram of bipolar configuration. In this configuration, two asymmetrical monopoles are connected through ground connected poles which can be connected using a neutral conductor. The advantage of this configuration is that in case of loss of any major element of the configuration, only 50% of the transmission capacity is lost.²⁵⁹

257. Dirk Van Hertem, Oriol Gomis-Bellmunt, and Jun Liang, *HVDC grids: for offshore and supergrid of the future*, vol. 51 (John Wiley & Sons, 2016).

258. Willem Leterme et al., "Overview of grounding and configuration options for meshed HVDC grids," *IEEE Transactions on Power Delivery* 29, no. 6 (2014): 2467–2475.

259. Dirk Van Hertem, Oriol Gomis-Bellmunt, and Jun Liang, *HVDC grids: for offshore and supergrid of the future*, vol. 51 (John Wiley & Sons, 2016).

References

- ABB. *ABB's Hybrid HVDC Circuit Breaker*. <http://new.abb.com/grid/events/cigre2014/hvdc-breaker>.
- . *Generator step-up transformers (GSU)*. <http://new.abb.com/products/transformers/power/generator-step-up>.
- . *Harmonic filters CHARM*. <http://new.abb.com/high-voltage/capacitors/hv/harmonic-filters>.
- . *HVDC converter transformers*. <http://new.abb.com/products/transformers/power/hvdc-converter>.
- . *System inertia transformers*. <http://new.abb.com/products/transformers/power/system-inertia-transformers>.
- . *The new 525 kV extruded HVDC cable system*, 2014. <https://library.e.abb.com/public/7caadd110d270de5c1257d3b002ff3ee/The%5C%20new%5C%20525%5C%20kV%5C%20extruded%5C%20HVDC%5C%20cable%5C%20system%5C%20White%5C%20PaperFINAL.pdf>.
- . *Thyristor controlled series compensation*. <http://new.abb.com/facts/thyristor-controlled-series-compensation>.
- Akhmatov, Vladislav, Jørgen Nygaard Nielsen, Jan Thisted, et al. “Siemens Wind Power 3.6 MW wind turbines for large offshore wind farms.” In *Proc. 7th International Workshop on Large Scale Integration of Wind Power and on Transmission Networks for Offshore Wind Farms*, 494–497. Energynautics GmbH, 2008.
- Ali, Mohd Hasan. *Wind energy systems: solutions for power quality and stabilization*. CRC Press, 2012.
- Ardelean, Mircea, and Philip Minnebo. *HVDC Submarine Power Cables in the World*. JRC Technical Reports, 2015. <http://publications.jrc.ec.europa.eu/repository/bitstream/JRC97720/ld-na-27527-en-n.pdf>.
- Association, European Wind Energy, et al. *Wind energy-the facts: a guide to the technology, economics and future of wind power*. Routledge, 2012.
- Bak, Christian and Zahle, Frederik and Bitsche, Robert and Kim, Taeseong and Yde, Anders and Henriksen, Lars Christian and Hansen, Morten Hartvig and Blasques, Jose Pedro Albergaria Amaral and Gaunaa, Mac and Natarajan, Anand. *The DTU 10-MW Reference Wind Turbine*. http://orbit.dtu.dk/files/55645274/The_DTU_10MW_Reference_Turbine_Christian_Bak.pdf, 2013.
- Barker, CD, and RS Whitehouse. “A current flow controller for use in HVDC grids.” In *10th IET International Conference on AC and DC Power Transmission (ACDC 2012)*. IET, 2012.

- Bell, K, et al. *Deliverable 15.2, TWENTIES project, Technical and economic impact analysis of the demonstrations in TF2*. http://orbit.dtu.dk/fedora/objects/orbit:129857/datastreams/file_0b45a5d2-e062-489e-8cfe-2401e55e4da4/content, 2013.
- Bradt, M, B Badrzadeh, E Camm, D Mueller, J Schoene, T Siebert, T Smith, M Starke, and R Walling. "Harmonics and resonance issues in wind power plants." In *Transmission and Distribution Conference and Exposition (T&D), 2012 IEEE PES*, 1–8. IEEE, 2012.
- Callavik, Magnus, Peter Lundberg, and O Hansson. "NORDLINK Pioneering VSC-HVDC interconnector between Norway and Germany." *ABB White Paper*, 2015.
- Chen, L, WH Lam, and AH Shamsuddin. "Potential scour for marine current turbines based on experience of offshore wind turbine." In *IOP Conference Series: Earth and Environmental Science*, 16:012057. 1. IOP Publishing, 2013.
- CIGRE Brochure. *Active Filters in HVDC Applications*, 2003.
- . *Technical Requirements and specifications of state-of-the-art HVDC switching equipment*, 2017.
- DNV. *Design of Offshore Wind Turbine Structures*. <https://rules.dnvgl.com/docs/pdf/DNV/codes/docs/2014-05/0s-J101.pdf>, 2014.
- e-Highway2050. *D3.2 - Technology innovation needs*. http://www.e-highway2050.eu/fileadmin/documents/Results/D3.2_Technology_innovation_needs_20151202.pdf, 2015.
- . *Technology Assessment Report (HVDC) - Annex to D3.1 - Technology Assessment Report*. http://www.e-highway2050.eu/fileadmin/documents/Results/D3/report_HVDC.pdf, 2014.
- ENTSO-E. *Offshore Transmission Technology*. http://www.benelux.int/files/6814/0923/4514/offshore_grid_technology.pdf.
- Esteban, M, J Lopes-Gutierrez, J Diez, and V Negro. "Foundations for offshore wind farms." In *Proceedings of the 12th International Conference on Environmental Science and Technology, Rhodes, Greece*, 516–523. 2011.
- EU-FP7 project - REseArch, methodoLogies and technologieS for the effective development of pan-European key GRID infrastructures to support the achievement of a reliable, competitive and sustainable electrical supply*. <http://realisegrid.rse-web.it/>.
- Europacable. *An Introduction to High Voltage Direct Current (HVDC) Subsea Cables Systems*. <http://www.europacable.eu/wp-content/uploads/2017/07/Introduction-to-HVDC-Subsea-Cables-16-July-2012.pdf>, 2012.
- . *An Introduction to High Voltage Direct Current (HVDC) Underground Cables*. http://www.europacable.eu/wp-content/uploads/2017/07/Introduction_to_HVDC_Underground_Cables_October_2011.pdf, 2011.

- European Commission. *Technology readiness levels (TRL)*. https://ec.europa.eu/research/participants/data/ref/h2020/wp/2014_2015/annexes/h2020-wp1415-annex-g-trl_en.pdf.
- European Wind Energy Association(EWEA). *Deep water. the next step for offshore wind energy*. http://www.ewea.org/fileadmin/files/library/publications/reports/Deep_Water.pdf, 2013.
- EWEA. *The European offshore wind industry - key trends and statistics 2015*, 2016. <https://www.ewea.org/fileadmin/files/library/publications/statistics/EWEA-European-Offshore-Statistics-2015.pdf>.
- Francois, P Labra, S Sanz Verdugo, H Fernández Álvarez, S Guyomarch, and J Loncle. “INELFE—Europe’s first integrated onshore HVDC interconnection.” In *Power and Energy Society General Meeting, 2012 IEEE*, 1–8. IEEE, 2012.
- Friends of the SuperGrid. *Roadmap to the Supergrid Technologies*. http://mainstream-downloads.opendebate.co.uk/downloads/WG2_Roadmap_to_the_Supergrid_Technologies_2013_Final_v2.pdf, 2013.
- Fujita, Hideaki, and Hirofumi Akagi. “A practical approach to harmonic compensation in power systems-series connection of passive and active filters.” *IEEE Transactions on industry applications* 27, no. 6 (1991): 1020–1025.
- Garbatov, Y (Ed.), and C (Ed.) Guedes Soares. *Progress in the Analysis and Design of Marine Structures*. CRC Press, London, 2017.
- Glover, J Duncan, Mulukutla S Sarma, and Thomas Overbye. *Power System Analysis & Design, SI Version*. Cengage Learning, 2012.
- Grid Innovation Online. *Technology Database*. <http://www.gridinnovation-online.eu/Technology-Database>.
- Gunnarsson, Stefan, Lin Jiang, and Anders Petersson. “Active filters in HVDC transmissions.” In *Proceedings of the 40th Session Regular Meeting of the CIGRÉ Study Committee B4—HVDC and Power Electronics Equipments*. 2009.
- Hagar, Abdelrahman. “A new family of transformerless modular DC-DC converters for high power applications.” PhD diss., University of Toronto, 2011.
- Hansen, Anca D, Florin Iov, Frede Blaabjerg, and Lars H Hansen. “Review of contemporary wind turbine concepts and their market penetration.” *Wind Engineering* 28, no. 3 (2004): 247–263.
- Hansen, Anca D, Clemens Jauch, Poul Ejnar Sørensen, Florin Iov, and Frede Blaabjerg. *Dynamic wind turbine models in power system simulation tool DIgSILENT*. Technical report. 2004.
- Hansen, Anca Daniela, Nicolaos Antonio Cutululis, P Sorensen, and Florin Iov. “Grid integration impacts on wind turbine design and development.” In *PowerTech, 2009 IEEE Bucharest*, 1–7. IEEE, 2009.

- Higgins, Paraic, and Aoife Foley. "The evolution of offshore wind power in the United Kingdom." *Renewable and sustainable energy reviews* 37 (2014): 599–612.
- Hingorani, Narain G, and Laszlo Gyugyi. *Understanding FACTS*. IEEE press, 2000.
- Innovative Wind Conversion Systems (10-20MW) for Offshore Applications, INNWIND Project*. www.innwind.eu.
- International Renewable Energy Agency(Irena). *Renewable energy technologies: Cost analysis series*. https://www.irena.org/DocumentDownloads/Publications/RE_Technologies_Cost_Analysis-WIND_POWER.pdf, 2012.
- IRENE-40.eu. *IRENE-40 Technology Database*. <http://database.irene40.eu/>.
- Jovcic, Dragan. "Bidirectional, high-power DC transformer." *IEEE transactions on Power Delivery* 24, no. 4 (2009): 2276–2283.
- Kaiser, Mark J, and Brian F Snyder. "Offshore Wind Energy System Components." In *Offshore Wind Energy Cost Modeling*, 13–30. Springer, 2012.
- Khan, Faisal H, and Leon M Tolbert. "A multilevel modular capacitor-clamped DC–DC converter." *IEEE Transactions on Industry Applications* 43, no. 6 (2007): 1628–1638.
- Knight, Sara. *Analysis: Siemens' radical substation plan*. News Article - WindPower Offshore, 2015. <http://www.windpoweroffshore.com/article/1338456/analysis-siemens-radical-substation-plan>.
- Konstantelos, Ioannis, Danny Pudjianto, Goran Strbac, Jan De Decker, Pieter Joseph, Aurore Flament, Paul Kreutzkamp, Fabio Genoese, Leif Rehfeldt, Anna-Kathrin Wallasch, et al. "Integrated North Sea grids: The costs, the benefits and their distribution between countries." *Energy Policy* 101 (2017): 28–41.
- Lee, Soo-Bong, Tae-Ho Lee, Eui-Hwan Jung, Yoon-Hyoung Kim, Hee-Chan Park, Sung-Yun Kim, Su-Kil Lee, Jin-Ho Nam, Seung-Ik Jeon, and Wan-Ki Park. "Development of 250kV HVDC XLPE cable system in Korea." In *Electrical Insulating Materials (ISEIM), Proceedings of 2014 International Symposium on*, 334–337. IEEE, 2014.
- Leterme, Willem, Pieter Tielens, Steven De Boeck, and Dirk Van Hertem. "Overview of grounding and configuration options for meshed HVDC grids." *IEEE Transactions on Power Delivery* 29, no. 6 (2014): 2467–2475.
- Matsui, Yoshihiko, K Nagatake, M Takeshita, K Katsumata, A Sano, H Ichikawa, H Saitohu, and M Sakaki. "Development and technology of high voltage VCBs; Breaf history and state of art." In *Discharges and Electrical Insulation in Vacuum, 2006. ISDEIV'06. International Symposium on*, 1:253–256. IEEE, 2006.
- Meier, Stephan, Tommy Kjellqvist, Staffan Norrga, and Hans-Peter Nee. "Design considerations for medium-frequency power transformers in offshore wind farms." In *Power Electronics and Applications, 2009. EPE'09. 13th European Conference on*, 1–12. IEEE, 2009.

- Migliavacca, Gianluigi. *Advanced technologies for future transmission grids*. Springer Science & Business Media, 2012.
- Mitsubishi Vestas Offshore. *VI64-8.0 MW*. <http://www.mhivestasoffshore.com/innovations/>.
- . *World's most powerful wind turbine once again smashes 24 hour power generation record as 9 MW wind turbine is launched*. <http://www.mhivestasoffshore.com/new-24-hour-record/>.
- Monopiles Support Structures*. <http://www.4coffshore.com/windfarms/monopiles-support-structures-aid4.html>.
- Negro, Vicente, et al. "Monopiles in offshore wind: Preliminary estimate of main dimensions." *Ocean Engineering* 133 (2017): 253–261.
- NKT. *640 kV extruded HVDC cable system*, 2017. http://www.nkt.de/fileadmin/user_upload/01_Page_images_global/general_images_pages/About_us/Innovation/640_kV_extruded_HVDC.pdf.
- NordBalt*. <https://en.wikipedia.org/wiki/NordBalt>.
- Northern Pass Project-Diagrams of Cross-Section of Underground Cables*. <https://energy.gov/sites/prod/files/2013/08/f2/Exhibit\%203\%20-\%20Diagrams\%20of\%20Cross-Section\%20of\%20Underground\%20Cables.pdf>.
- Offshore Wind Industry. *EEW has produced the world's heaviest Monopile*. <http://www.offshorewindindustry.com/news/eew-produced-worlds-heaviest-monopile>.
- Ortiz, G, J Biela, D Bortis, and JW Kolar. "1 Megawatt, 20 kHz, isolated, bidirectional 12kV to 1.2 kV DC-DC converter for renewable energy applications." In *Power Electronics Conference (IPEC), 2010 International*, 3212–3219. IEEE, 2010.
- PANCIATICI, Patrick, WP Leader, Camille PACHE, RTE Jean MAEGHT, and RTE Alexander WEBER. "e-HIGHWAY 2050 Modular Development Plan of the Pan-European Transmission System 2050."
- Pannu, Mohinder and Valent, Yoram and Garbi, Uri. "Saturated Core Fault Current Limiters: successful testing/service performance." *Transformers Magazine* 2, no. 4 (2015): 78–86.
- Prysmian. *High Voltage Cables*. http://nl.prysmiangroup.com/nl/business_markets/markets/hv-and-submarine/downloads/datasheets/Prysmian-Delft-HVac.pdf.
- REALISEGRID. *D3.3.2 Review of costs of transmission infrastructures, including cross border connections*. http://realisegrid.rse-web.it/content/files/File/Publications%5C%20and%5C%20results/Deliverable_REALISEGRID_3.3.2.pdf.

- Reeves, Eric Alwyn, and Martin Heathcote. *Newnes electrical pocket book*. Routledge, 2013.
- Siemens. *Circuit Breakers*. <https://www.energy.siemens.com/us/en/power-transmission/high-voltage-products/circuit-breaker/sf6-hv-circuitbreaker-dtc.htm>.
- . *DC commutation breaker successfully tested in 5000-A HVDC system in China*. [https://www.siemens.com/press/en/pressrelease/?press=/en/pressrelease/2015/energymanagement/pr2015010107emen.htm&content\[\]=EM](https://www.siemens.com/press/en/pressrelease/?press=/en/pressrelease/2015/energymanagement/pr2015010107emen.htm&content[]=EM).
- SIEMENS. *HVDC Transformers*. <https://www.energy.siemens.com/hq/en/power-transmission/transformers/hvdc-transformers/hvdc-transformers.htm#content=Description>.
- Siemens Wind Power. *SWT-7.0-154*. <http://www.siemens.com/global/en/home/markets/wind/turbines/swt-7-0-154.html>.
- Singh, Bhim, Kamal Al-Haddad, and Amrbrish Chandra. "A review of active filters for power quality improvement." *IEEE transactions on industrial electronics* 46, no. 5 (1999): 960–971.
- Song, Yong-Hua, and Allan Johns. *Flexible ac transmission systems (FACTS)*. 30. IET, 1999.
- Steelwind Nordenham*. <http://www.steelwind-nordenham.de/steelwind/produkte/megamonopiles/index.shtml.en>.
- Steigerwald, Robert L, Rik W De Doncker, and H Kheraluwala. "A comparison of high-power DC-DC soft-switched converter topologies." *IEEE transactions on industry applications* 32, no. 5 (1996): 1139–1145.
- Steiner, Michael, and Harry Reinold. "Medium frequency topology in railway applications." In *Power Electronics and Applications, 2007 European Conference on*, 1–10. IEEE, 2007.
- SuperPower-Inc. *HTS Transmission Cable*. <http://www.superpower-inc.com/content/hts-transmission-cable>.
- Taufiq, J. "Power electronics technologies for railway vehicles." In *Power Conversion Conference-Nagoya, 2007. PCC'07*, 1388–1393. IEEE, 2007.
- Tripile Support Structures*. <http://www.4coffshore.com/windfarms/tripile-support-structures-aid6.html>.
- Tripod Support Structures*. <http://www.4coffshore.com/windfarms/tripod-support-structures-aid7.html>.
- Vaféas, A, S Galant, and T Pagano. "Final WP1 report on cost/benefit analysis of innovative technologies and grid technologies roadmap report validated by the external partners." *REALISEGRID Deliverable D 1* (2011).

- Van Hertem, Dirk, Oriol Gomis-Bellmunt, and Jun Liang. *HVDC grids: for offshore and supergrid of the future*. Vol. 51. John Wiley & Sons, 2016.
- Viking Link*. <http://viking-link.com/>.
- Vrana, Til Kristian, and Raymundo E Torres Olguin. "Technology perspectives of the North Sea Offshore and storage Network (NSON)," 2015.
- Wilfried, Njomo Wandji, Anand Natarajan, and Nikolay Dimitrov. "Influence of model parameters on the design of large diameter monopiles for multi megawatt offshore wind turbines at 50 m water depths." *Wind Energy*, 2018.
- Wolter, C, H K Jacobsen, G Rogdakis, L Zeni, and Cutululis N. "Overplanting in offshore wind power plants in different regulatory regimes." In *proc. 15th International Workshop on large scale integration of wind power into power systems*. 2016.
- Yang, Liyu, Tiefu Zhao, Jun Wang, and Alex Q Huang. "Design and analysis of a 270kW five-level dc/dc converter for solid state transformer using 10kV SiC power devices." In *Power Electronics Specialists Conference, 2007. PESC 2007. IEEE*, 245–251. IEEE, 2007.
- Yunus, Kalid. "Steady state analysis of HVDC grid with Wind Power Plants." PhD diss., Chalmers University of Technology, 2017.
- Zaccone, E. *High voltage underground and subsea cable technology options for future transmission in Europe*. presentation at E-Highway2050 WP3 workshop April 15th, 2014 Brussels, 2014. http://www.e-highway2050.eu/fileadmin/documents/Workshop4/7b_Europacable_for_WP3_Workshop_Technology_Presentation_15_April_2014_c.pdf.
- Zhang, Fan, Lei Du, Fang Zheng Peng, and Zhaoming Qian. "A new design method for high-power high-efficiency switched-capacitor DC–DC converters." *IEEE Transactions on Power Electronics* 23, no. 2 (2008): 832–840.