

MIXING CONSOLE

MG20XU / MG20
MG16XU / MG16
MG12XU / MG12

Owner's Manual

Precautions **pages 5, 6**

Quick Start Guide **pages 9 to 11**

Troubleshooting **pages 29 to 31**

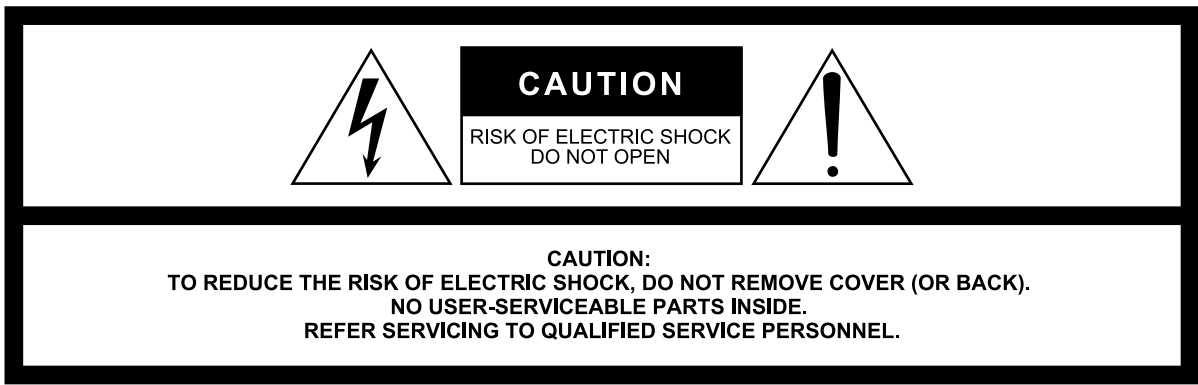

The above warning is located on the rear of the unit.
L'avertissement ci-dessus est situé à l'arrière de l'appareil.

Explanation of Graphical Symbols Explication des symboles

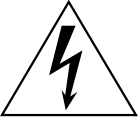

The lightning flash with arrowhead symbol within an equilateral triangle is intended to alert the user to the presence of uninsulated "dangerous voltage" within the product's enclosure that may be of sufficient magnitude to constitute a risk of electric shock to persons.
L'éclair avec une flèche à l'intérieur d'un triangle équilatéral est destiné à attirer l'attention de l'utilisateur sur la présence d'une « tension dangereuse » non isolée à l'intérieur de l'appareil, pouvant être suffisamment élevée pour constituer un risque d'électrocution.



The exclamation point within an equilateral triangle is intended to alert the user to the presence of important operating and maintenance (servicing) instructions in the literature accompanying the product.
Le point d'exclamation à l'intérieur d'un triangle équilatéral est destiné à attirer l'attention de l'utilisateur sur la présence d'instructions importantes sur l'emploi ou la maintenance (réparation) de l'appareil dans la documentation fournie.

IMPORTANT SAFETY INSTRUCTIONS

- 1 Read these instructions.
- 2 Keep these instructions.
- 3 Heed all warnings.
- 4 Follow all instructions.
- 5 Do not use this apparatus near water.
- 6 Clean only with dry cloth.
- 7 Do not block any ventilation openings. Install in accordance with the manufacturer's instructions.
- 8 Do not install near any heat sources such as radiators, heat registers, stoves, or other apparatus (including amplifiers) that produce heat.
- 9 Do not defeat the safety purpose of the polarized or grounding-type plug. A polarized plug has two blades with one wider than the other. A grounding type plug has two blades and a third grounding prong. The wide blade or the third prong are provided for your safety. If the provided plug does not fit into your outlet, consult an electrician for replacement of the obsolete outlet.
- 10 Protect the power cord from being walked on or pinched particularly at plugs, convenience receptacles, and the point where they exit from the apparatus.
- 11 Only use attachments/accessories specified by the manufacturer.
- 12 Use only with the cart, stand, tripod, bracket, or table specified by the manufacturer, or sold with the apparatus. When a cart is used, use caution when moving the cart/apparatus combination to avoid injury from tip-over.
- 13 Unplug this apparatus during lightning storms or when unused for long periods of time.
- 14 Refer all servicing to qualified service personnel. Servicing is required when the apparatus has been damaged in any way, such as power-supply cord or plug is damaged, liquid has been spilled or objects have fallen into the apparatus, the apparatus has been exposed to rain or moisture, does not operate normally, or has been dropped.



WARNING

TO REDUCE THE RISK OF FIRE OR ELECTRIC SHOCK, DO NOT EXPOSE THIS APPARATUS TO RAIN OR MOISTURE.

(UL60065_03)

PRÉCAUTIONS CONCERNANT LA SÉCURITÉ

- 1 Lire ces instructions.
- 2 Conserver ces instructions.
- 3 Tenir compte de tous les avertissements.
- 4 Suivre toutes les instructions.
- 5 Ne pas utiliser ce produit à proximité d'eau.
- 6 Nettoyer uniquement avec un chiffon propre et sec.
- 7 Ne pas bloquer les orifices de ventilation. Installer l'appareil conformément aux instructions du fabricant.
- 8 Ne pas installer l'appareil à proximité d'une source de chaleur comme un radiateur, une bouche de chaleur, un poêle ou tout autre appareil (y compris un amplificateur) produisant de la chaleur.
- 9 Ne pas modifier le système de sécurité de la fiche polarisée ou de la fiche de terre. Une fiche polarisée dispose de deux broches dont une est plus large que l'autre. Une fiche de terre dispose de deux broches et d'une troisième pour le raccordement à la terre. Cette broche plus large ou cette troisième broche est destinée à assurer la sécurité de l'utilisateur. Si la fiche équipant l'appareil n'est pas compatible avec les prises de courant disponibles, faire remplacer les prises par un électricien.
- 10 Acheminer les cordons d'alimentation de sorte qu'ils ne soient pas piétinés ni coincés, en faisant tout spécialement attention aux fiches, prises de courant et au point de sortie de l'appareil.
- 11 Utiliser exclusivement les fixations et accessoires spécifiés par le fabricant.
- 12 Utiliser exclusivement le chariot, le stand, le trépied, le support ou la table recommandés par le fabricant ou vendus avec cet appareil. Si l'appareil est posé sur un chariot, déplacer le chariot avec précaution pour éviter tout risque de chute et de blessure.
- 13 Débrancher l'appareil en cas d'orage ou lorsqu'il doit rester hors service pendant une période prolongée.
- 14 Confier toute réparation à un personnel qualifié. Faire réparer l'appareil s'il a subi tout dommage, par exemple si la fiche ou le cordon d'alimentation est endommagé, si du liquide a coulé ou des objets sont tombés à l'intérieur de l'appareil, si l'appareil a été exposé à la pluie ou à de l'humidité, si l'appareil ne fonctionne pas normalement ou est tombé.



AVERTISSEMENT

POUR RÉDUIRE LES RISQUES D'INCENDIE OU DE DÉCHARGE ÉLECTRIQUE, N'EXPOSEZ PAS CET APPAREIL À LA PLUIE OU À L'HUMIDITÉ.

(UL60065_03)

FCC INFORMATION (U.S.A.)

1. IMPORTANT NOTICE: DO NOT MODIFY THIS UNIT!

This product, when installed as indicated in the instructions contained in this manual, meets FCC requirements. Modifications not expressly approved by Yamaha may void your authority, granted by the FCC, to use the product.

2. IMPORTANT:

When connecting this product to accessories and/or another product use only high quality shielded cables. Cable/s supplied with this product MUST be used. Follow all installation instructions. Failure to follow instructions could void your FCC authorization to use this product in the USA.

3. NOTE:

This product has been tested and found to comply with the requirements listed in FCC Regulations, Part 15 for Class "B" digital devices. Compliance with these requirements provides a reasonable level of assurance that your use of this product in a residential environment will not result in harmful interference with other electronic devices. This equipment generates/uses radio frequencies and, if not installed and used according to the instructions found in the users manual, may cause interference harmful to the operation of other electronic devices. Compliance with FCC regulations does not guarantee that interference will not occur in all

installations. If this product is found to be the source of interference, which can be determined by turning the unit "OFF" and "ON", please try to eliminate the problem by using one of the following measures:

Relocate either this product or the device that is being affected by the interference.

Utilize power outlets that are on different branch (circuit breaker or fuse) circuits or install AC line filter/s.

In the case of radio or TV interference, relocate/reorient the antenna. If the antenna lead-in is 300 ohm ribbon lead, change the lead-in to co-axial type cable.

If these corrective measures do not produce satisfactory results, please contact the local retailer authorized to distribute this type of product. If you can not locate the appropriate retailer, please contact Yamaha Corporation of America, Electronic Service Division, 6600 Orangethorpe Ave, Buena Park, CA90620

The above statements apply ONLY to those products distributed by Yamaha Corporation of America or its subsidiaries.

* This applies only to products distributed by YAMAHA CORPORATION OF AMERICA.

(class B)

COMPLIANCE INFORMATION STATEMENT (DECLARATION OF CONFORMITY PROCEDURE)

Responsible Party : Yamaha Corporation of America
Address : 6600 Orangethorpe Ave., Buena Park,
Calif. 90620
Telephone : 714-522-9011
Type of Equipment : Mixing Console
Model Name : MG20XU/MG16XU/MG12XU

This device complies with Part 15 of the FCC Rules.

Operation is subject to the following two conditions:

- 1) this device may not cause harmful interference, and
- 2) this device must accept any interference received including interference that may cause undesired operation.

See user manual instructions if interference to radio reception is suspected.

* This applies only to products distributed by
YAMAHA CORPORATION OF AMERICA.

(FCC DoC)

IMPORTANT NOTICE FOR THE UNITED KINGDOM Connecting the Plug and Cord

WARNING: THIS APPARATUS MUST BE EARTHED IMPORTANT. The wires in this mains lead are coloured in accordance with the following code:

GREEN-AND-YELLOW	: EARTH
BLUE	: NEUTRAL
BROWN	: LIVE

As the colours of the wires in the mains lead of this apparatus may not correspond with the coloured markings identifying the terminals in your plug proceed as follows:

The wire which is coloured GREEN-and-YELLOW must be connected to the terminal in the plug which is marked by the letter E or by the safety earth symbol  or colored GREEN or GREEN-and-YELLOW.

The wire which is coloured BLUE must be connected to the terminal which is marked with the letter N or coloured BLACK.

The wire which is coloured BROWN must be connected to the terminal which is marked with the letter L or coloured RED.

(3 wires)

이 기기는 가정용(B급) 전자파적합기기로서 주로 가정에서 사용하는 것을 목적으로 하며, 모든 지역에서 사용할 수 있습니다.

(class b korea)

In Finland: Laite on liitettävä suojamaadoituskoskettimilla varustettuun pistorasiaan.

In Norway: Apparatet må tilkoples jordet stikkontakt.

In Sweden: Apparatens skall anslutas till jordat uttag.

(class I hokuo)

Information for users on collection and disposal of old equipment:



This symbol on the products, packaging, and/or accompanying documents means that used electrical and electronic products should not be mixed with general household waste.

For proper treatment, recovery and recycling of old products, please take them to applicable collection points, in accordance with your national legislation.

By disposing of these products correctly, you will help to save valuable resources and prevent any potential negative effects on human health and the environment which could otherwise arise from inappropriate waste handling.

For more information about collection and recycling of old products, please contact your local municipality, your waste disposal service or the point of sale where you purchased the items.

For business users in the European Union:

If you wish to discard electrical and electronic equipment, please contact your dealer or supplier for further information.

Information on Disposal in other Countries outside the European Union:

This symbol is only valid in the European Union. If you wish to discard these items, please contact your local authorities or dealer and ask for the correct method of disposal.

(weee_eu_en_02)

PRECAUTIONS

PLEASE READ CAREFULLY BEFORE PROCEEDING

Please keep this manual in a safe place for future reference.



WARNING

Always follow the basic precautions listed below to avoid the possibility of serious injury or even death from electrical shock, short-circuiting, damages, fire or other hazards. These precautions include, but are not limited to, the following:

Power supply/power cord

- Do not place the power cord near heat sources such as heaters or radiators, and do not excessively bend or otherwise damage the cord, place heavy objects on it, or place it in a position where anyone could walk on, trip over, or roll anything over it.
- Only use the voltage specified as correct for the device. The required voltage is printed on the name plate of the device.
- Use only the supplied power cord/plug.
If you intend to use the device in an area other than in the one you purchased, the included power cord may not be compatible. Please check with your Yamaha dealer.
- Check the electric plug periodically and remove any dirt or dust which may have accumulated on it.
- Be sure to connect to an appropriate outlet with a protective grounding connection. Improper grounding can result in electrical shock, damage to the device(s), or even fire.

Do not open

- This device contains no user-serviceable parts. Do not open the device or attempt to disassemble the internal parts or modify them in any way. If it should appear to be malfunctioning, discontinue use immediately and have it inspected by qualified Yamaha service personnel.

Water warning

- Do not expose the device to rain, use it near water or in damp or wet conditions, or place on it any containers (such as vases, bottles or glasses) containing liquids which might spill into any openings. If any liquid such as water seeps into the device, turn off the power immediately and unplug the power cord from the AC outlet. Then have the device inspected by qualified Yamaha service personnel.
- Never insert or remove an electric plug with wet hands.

Fire warning

- Do not put burning items, such as candles, on the unit. A burning item may fall over and cause a fire.

If you notice any abnormality

- When one of the following problems occur, immediately turn off the power switch and disconnect the electric plug from the outlet. Then have the device inspected by Yamaha service personnel.
 - The power cord or plug becomes frayed or damaged.
 - It emits unusual smells or smoke.
 - Some object has been dropped into the device.
 - There is a sudden loss of sound during use of the device.
- If this device should be dropped or damaged, immediately turn off the power switch, disconnect the electric plug from the outlet, and have the device inspected by qualified Yamaha service personnel.



CAUTION

Always follow the basic precautions listed below to avoid the possibility of physical injury to you or others, or damage to the device or other property. These precautions include, but are not limited to, the following:

Power supply/power cord

- When removing the electric plug from the device or an outlet, always hold the plug itself and not the cord. Pulling by the cord can damage it.
- Remove the electric plug from the outlet when the device is not to be used for extended periods of time, or during electrical storms.

Location

- Do not place the device in an unstable position where it might accidentally fall over.
- Do not block the vents. This device has ventilation holes at the bottom/sides to prevent the internal temperature from becoming too high. In particular, do not place the device on its side or upside down. Inadequate ventilation can result in overheating, possibly causing damage to the device(s), or even fire.
- Do not place the device in a location where it may come into contact with corrosive gases or salt air. Doing so may result in malfunction.
- Before moving the device, remove all connected cables.
- When setting up the device, make sure that the AC outlet you are using is easily accessible. If some trouble or malfunction occurs, immediately turn off the power switch and disconnect the plug from the outlet. Even when the power switch is turned off, electricity is still flowing to the product at the minimum level. When you are not using the product for a long time, make sure to unplug the power cord from the wall AC outlet.
- When rackmounting the device, always use two or more people. Attempting to lift the device by yourself may damage your back, result in other injury, or cause damage to the device itself.
- If the device is mounted in an EIA standard rack, carefully read the section "Precautions for Rack Mounting" on page 35. Inadequate ventilation can result in overheating, possibly causing damage to the device(s), malfunction, or even fire.

Connections

- Before connecting the device to other devices, turn off the power for all devices. Before turning the power on or off for all devices, set all volume levels to minimum.

Maintenance

- Remove the power plug from the AC outlet when cleaning the device.

Handling caution

- Do not insert your fingers or hands in any gaps or openings on the device (vents).
- Avoid inserting or dropping foreign objects (paper, plastic, metal, etc.) into any gaps or openings on the device (vents). If this happens, turn off the power immediately and unplug the power cord from the AC outlet. Then have the device inspected by qualified Yamaha service personnel.

- Do not rest your weight on the device or place heavy objects on it, and avoid use excessive force on the buttons, switches or connectors.
- Do not use speakers or headphones for a long period of time at a high or uncomfortable volume level, since this can cause permanent hearing loss. If you experience any hearing loss or ringing in the ears, consult a physician.

Yamaha cannot be held responsible for damage caused by improper use or modifications to the device, or data that is lost or destroyed.

NOTICE

To avoid the possibility of malfunction/damage to the product, damage to data, or damage to other property, follow the notices below.

■ Handling and Maintenance

- Do not use the device in the vicinity of a TV, radio, stereo equipment, mobile phone, or other electric devices. Otherwise, the device, TV, or radio may generate noise.
- Do not expose the device to excessive dust or vibration, or extreme cold or heat (such as in direct sunlight, near a heater, or in a car during the day), in order to prevent the possibility of panel disfiguration, unstable operation, or damage to the internal components.
- Do not place vinyl, plastic or rubber objects on the device, since this might discolor the panel.
- When cleaning the device, use a dry and soft cloth. Do not use paint thinners, solvents, cleaning fluids, or chemical-impregnated wiping cloths.
- Condensation can occur in the device due to rapid, drastic changes in ambient temperature—when the device is moved from one location to another, or air conditioning is turned on or off, for example. Using the device while condensation is present can cause damage. If there is reason to believe that condensation might have occurred, leave the device for several hours without turning on the power until the condensation has completely dried out.
- Avoid setting all equalizer controls and faders to their maximum. Depending on the condition of the connected devices, doing so may cause feedback and may damage the speakers.
- Do not apply oil, grease, or contact cleaner to the faders. Doing so may cause problems with electrical contact or fader motion.
- When turning on the AC power in your audio system, always turn on the power amplifier LAST, to avoid speaker damage. When turning the power off, the power amplifier should be turned off FIRST for the same reason.
- Always turn the power off when the device is not in use.

■ Connectors

XLR-type connectors are wired as follows (IEC60268 standard): pin 1: ground, pin 2: hot (+), and pin 3: cold (-).

Information

■ About this manual

- The illustrations as shown in this manual are for instructional purposes only, and may appear somewhat different from those on your device.
- Steinberg and Cubase are registered trademarks of Steinberg Media Technologies GmbH.
- The company names and product names in this manual are the trademarks or registered trademarks of their respective companies.
- This manual covers the MG20XU/MG20, MG16XU/MG16, and MG12XU/MG12 mixing consoles. In cases where different features need to be described for each model, the features for the MG16XU/MG16 and MG12XU/MG12 will be enclosed in brackets. (Example: CH13/14 – 19/20 {CH9/10 – 15/16} {CH1 – 7/8})
- In this manual, the term “MG” refers to all models collectively. The term “XU models” refers to the MG20XU, MG16XU, and MG12XU.
- Throughout this manual, all panel illustrations show the panel of the MG16XU, unless noted otherwise.

The model number, serial number, power requirements, etc., may be found on or near the name plate, which is at the rear of the unit. You should note this serial number in the space provided below and retain this manual as a permanent record of your purchase to aid identification in the event of theft.

Model No.

Serial No.

(rear_en_01)

Thank you for purchasing the Yamaha MG20XU/MG20/MG16XU/MG16/MG12XU/MG12 mixing console. Please read this manual thoroughly to get the most out of the product and ensure long-term, trouble-free use. After reading this manual, please keep it available for future reference.

Contents

Precautions	5	Appendix.....	32
Contents.....	7	General Specifications.....	32
Main Features	8	Effect Programs.....	33
Quick Start Guide	9	Jack and Connector List.....	34
Step 1 Preparing the Power Supply.....	9	Connector Types	34
Step 2 Making Connections	9	Rack Mounting.....	35
Step 3 Powering Up the System.....	9	Index.....	36
Step 4 Getting Sound to the Speakers	10		
Step 5 Using the Built-in Effects (XU Models Only)	11		
Setup.....	12		
Setup Examples	12		
Controls and Connectors	14		
Front Panel.....	14		
Rear Panel.....	15		
Input Channel Block	16		
Built-in Effects Block (XU Models Only)	22		
Master Block.....	24		
Power Block.....	27		
USB Block (XU Models Only).....	28		
Troubleshooting	29		
When No Sound Is Output	29		
Other	31		

Main Features

D-PRE and High-Quality Operational Amplifiers

Mono input channels are equipped with “D-PRE” Class-A discrete microphone preamplifiers. The D-PRE head amplifier features an inverted Darlington circuit used in high-end audio devices. This circuit uses multi-stage amplifying elements to ensure high current and low impedance, for an audio texture with crispness and richness in the low and mid frequencies. Combined with the specially-designed “MG01” operational amp, the overall result is full-bodied reproduction of low frequencies as well as sustained high frequencies. Input channels feature combo jacks, which can accept both XLR and TRS connectors. In addition, PAD circuitry allows line level input, to accommodate a wide variety of instruments.

Improved Convenience with Built-in Universal Switching Power Supply

The MG series features a universal switching power supply. This power supply supports input voltages of 100 V to 240 V, for stable operation even in environments where power voltage fluctuates easily. Lowering the impedance of the power supply has resulted in improved sound quality with a faster attack. An AC inlet allows simple installation in environments where portability is required, as well as when mounting the mixing console in a rack.

24 High-Quality Digital Effects (XU Models)

The XU models (MG20XU/MG16XU/MG12XU) feature 24 built-in effects that are based on SPX algorithms used by professionals. In particular, the high-quality reverb and delay expand the spatial quality of the sound with remarkable realism and naturalness.

24-bit/192 kHz USB Audio Interface (XU Models)

The XU models (MG20XU/MG16XU/MG12XU) feature a USB 2.0 audio interface capable of 24-bit/192 kHz sound quality. With the audio interface you can play back music from your computer, or use DAW software such as Cubase AI to record the mixer output. The XU models support USB Audio Class 2.0 so you can use them with USB Audio Class 2.0 compliant tablets and other devices, without the need to install drivers. The USB protocol uses asynchronous data transfer. Audio data is transferred based on a highly precise audio clock signal from the MG, for high quality recording and playback.

Accessories (Please check that they are included with your mixing console.)

- AC Power Cord
- Rack-Mount Kit (The RK-MG12 for the MG12XU/MG12 is sold separately.)
- Cubase AI Download Information (XU models):
Contains the access code necessary for downloading the Steinberg DAW software “Cubase AI”.
Visit the following Yamaha website for details on downloading and installing Cubase AI, and making necessary settings.
http://www.yamahaproaudio.com/mg_xu/
- Technical Specifications (English only):
Includes general specifications, input/output characteristics, dimensions, as well as a block diagram and level diagram.
- Owner’s Manual (this book)

Quick Start Guide

We'll begin this guide by connecting a pair of speakers and generating some stereo output. Note that the operations and procedures will vary somewhat according to the input devices you are using.

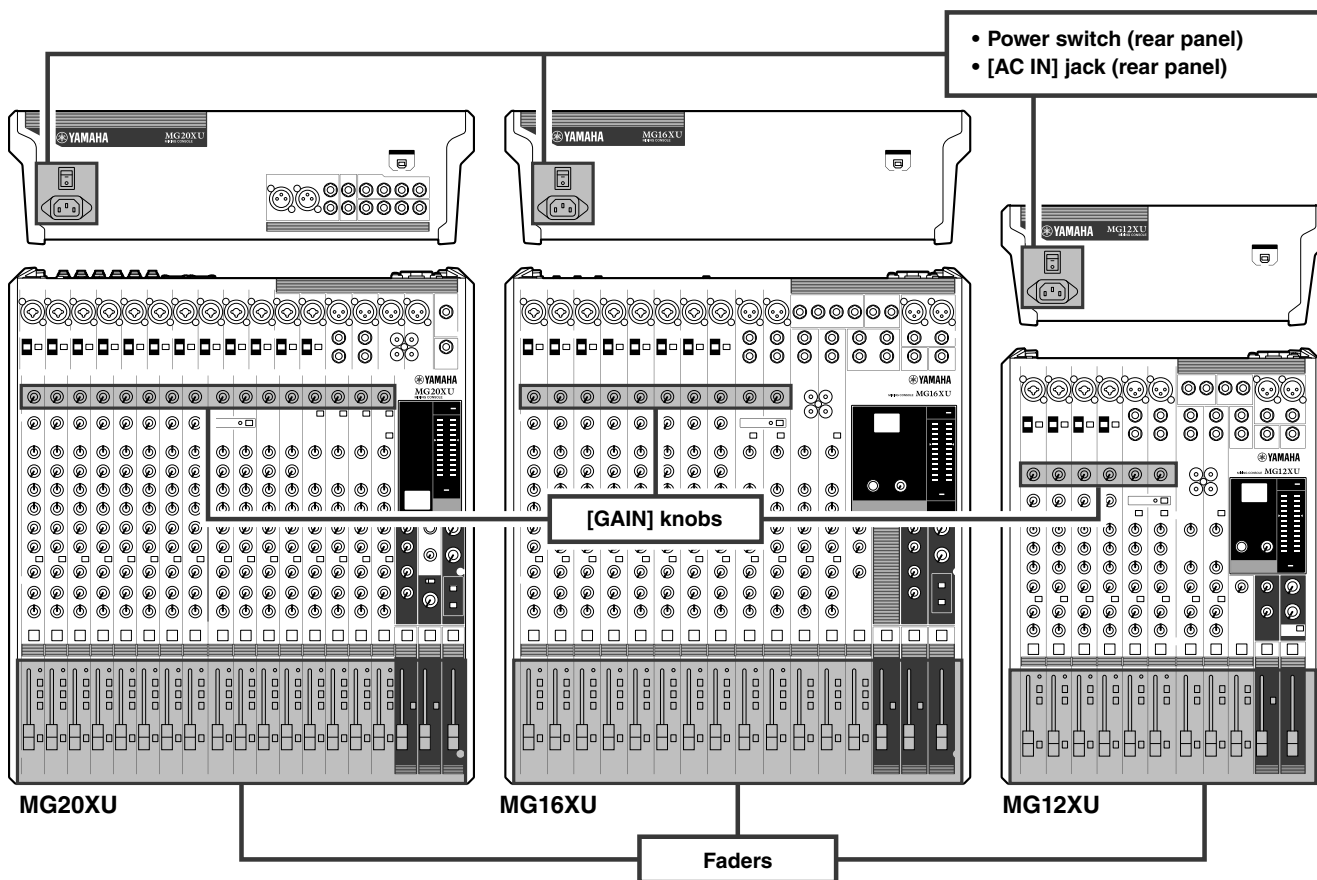

Step 1 Preparing the Power Supply

1. Make sure that the power switch of the unit is set to the “O” position (off).



2. Connect the socket of the included power cord to the [AC IN] jack on the rear panel.
3. Plug the power cord into a power outlet.

Step 2 Making Connections

1. Turn all the faders and [GAIN] knobs completely down.
2. Connect the microphones, instruments, and/or speakers you intend to use.

For details on making connections, see “Setup Examples” (pages 12 – 13), “Front Panel” and “Rear Panel” (pages 14 – 15).

Step 3 Powering Up the System

To prevent an unwanted burst of noise from the speakers, power up the devices in the following order: peripheral devices (instruments, microphones, etc.) → mixing console → power amps (or powered speakers).

Reverse this order when turning the power off.

⚠ WARNING

Be sure to turn the power on/off in the order given in Step 3 above every time you use the mixer. Failure to do so may result in loud noise bursts that can damage your equipment, your ears, or both.

NOTICE

If you are using condenser microphones that require phantom power, turn the mixer’s [PHANTOM +48V] switch on before turning on the power to the power amps or powered speakers. See page 17 for details. Also, read the details about the [PHANTOM +48V] switch on page 17 before turning the switch on.

Step 4 Getting Sound to the Speakers

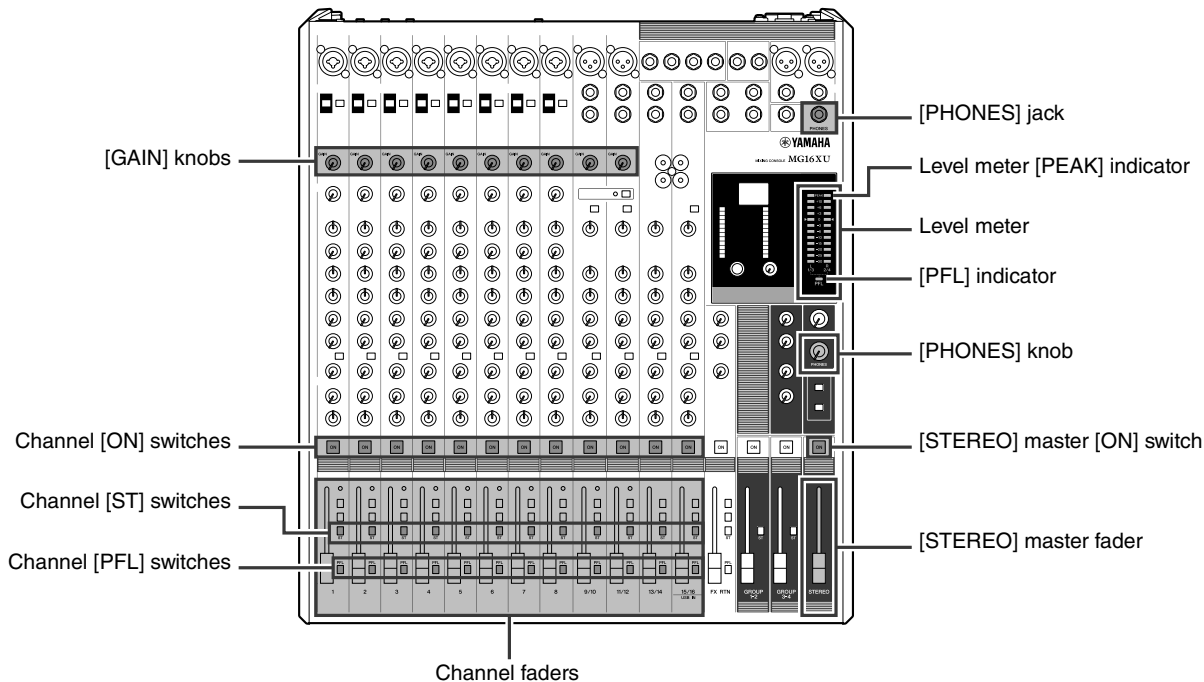

1. Turn on (**▲**) the [PFL] switches for each channel you are using.

NOTE

- When you turn on the [PFL] switch for a channel, you can monitor the signal for that channel through headphones connected to the [Phones] jack. The level of the signal is also shown on the level meter indicator, allowing you to more accurately check signal levels. After checking levels, turn the [PFL] switches off.
- When a [PFL] switch is turned on, the [PFL] indicator below the level meter flashes.

2. While playing your instrument or speaking into a microphone, adjust the input signal with the [GAIN] knob until it goes past the “0” (**◀**) position on the level meter only occasionally.

NOTE

If you connect a portable audio player, synthesizer, or other equipment to a stereo input channel that has no [GAIN] knob, adjust the output level on the connected device.

3. Turn on (**▲**) the [ON] switches for each channel you are using.

4. Turn on (**▲**) the [ST] switches for each channel you are using.

5. Turn off (**■**) all [PFL] switches.

Confirm that the [PFL] indicator below the level meter is off.

6. Turn on (**▲**) the [ON] switch for the [STEREO] master.

7. Raise the [STEREO] master fader to the “0” position.

8. Set the channel faders to create the desired initial balance.

9. Adjust the overall volume of the [STEREO] master fader.

The overall headphone level is adjusted by the [PHONES] knob.

NOTE

If the level meter [PEAK] indicator lights frequently, slightly lower the channel faders to avoid distortion.

■ Adjusting Tone and Level

- Equalizer ([HIGH]/[MID]/[LOW]) page 18
- [COMP] knobs page 17
- [GAIN] knobs page 17
- Channel faders page 19

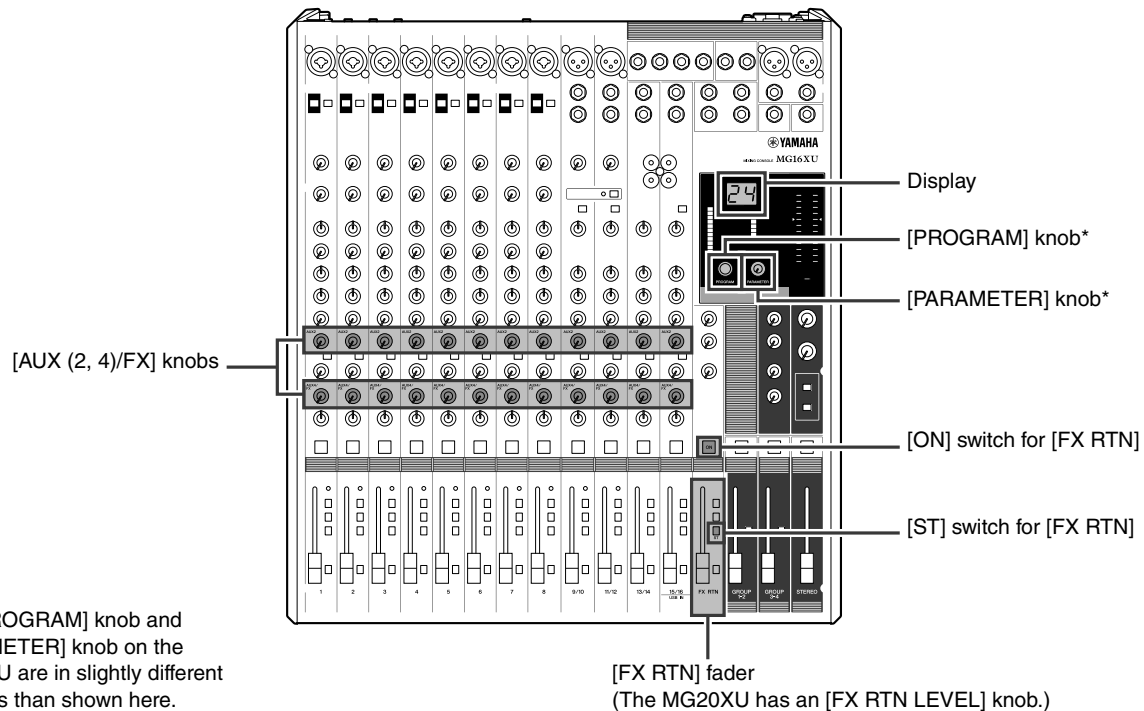

Step 5 Using the Built-in Effects (XU Models Only)



* The [PROGRAM] knob and [PARAMETER] knob on the MG20XU are in slightly different locations than shown here.

1. Turn the [PROGRAM] knob to select the desired effect, and then press the knob to enable it.

The selected effect program number flashes in the display.
For details about available effects, see the Effect Programs on page 33.

2. Turn on () the [ON] switch for [FX RTN].
3. Turn on () the [ST] switch for [FX RTN].

4. Raise the [FX RTN] fader to the “0” position.
5. Use the [AUX (2, 4)/FX] knobs to adjust the effect depth for each channel.
6. Use the [FX RTN] fader to adjust the overall effect depth of the selected effect.

You can use the [PARAMETER] knob (page 23) to adjust effect parameters such as reverb time and delay time. For details about the parameters of each effect that can be adjusted with the [PARAMETER] knob, see page 33.

■ Using Reverb and Delay

Your mixes can be further enhanced by using the built-in ambience effects such as reverb or delay.

Reverb and Delay Time

The optimum reverb time for a piece of music will depend on the music's tempo and density, but as a general rule longer reverb times are good for ballads, while shorter reverb times are more suited to up-tempo tunes. Delay times can be adjusted to create a wide variety of repeating rhythmic effects. When adding a delay to a vocal, for example, try setting the delay time to dotted eighth notes () corresponding to the tune's tempo.

Reverb Level

While working for many hours on a mix, your sense of hearing will start to dull slightly. This can lead to the perception that tracks with excess processing sound like the perfect mix. To avoid falling into this trap, start with reverb level all the way down, then gradually bring the reverb into the mix until you can just hear the difference. Any more than this normally becomes a special effect or, worse yet, makes the sound muddy and indistinct. In general, you don't want reverb to dominate the mix, so you should apply it judiciously.

2. For Events and Parties

Front Panel

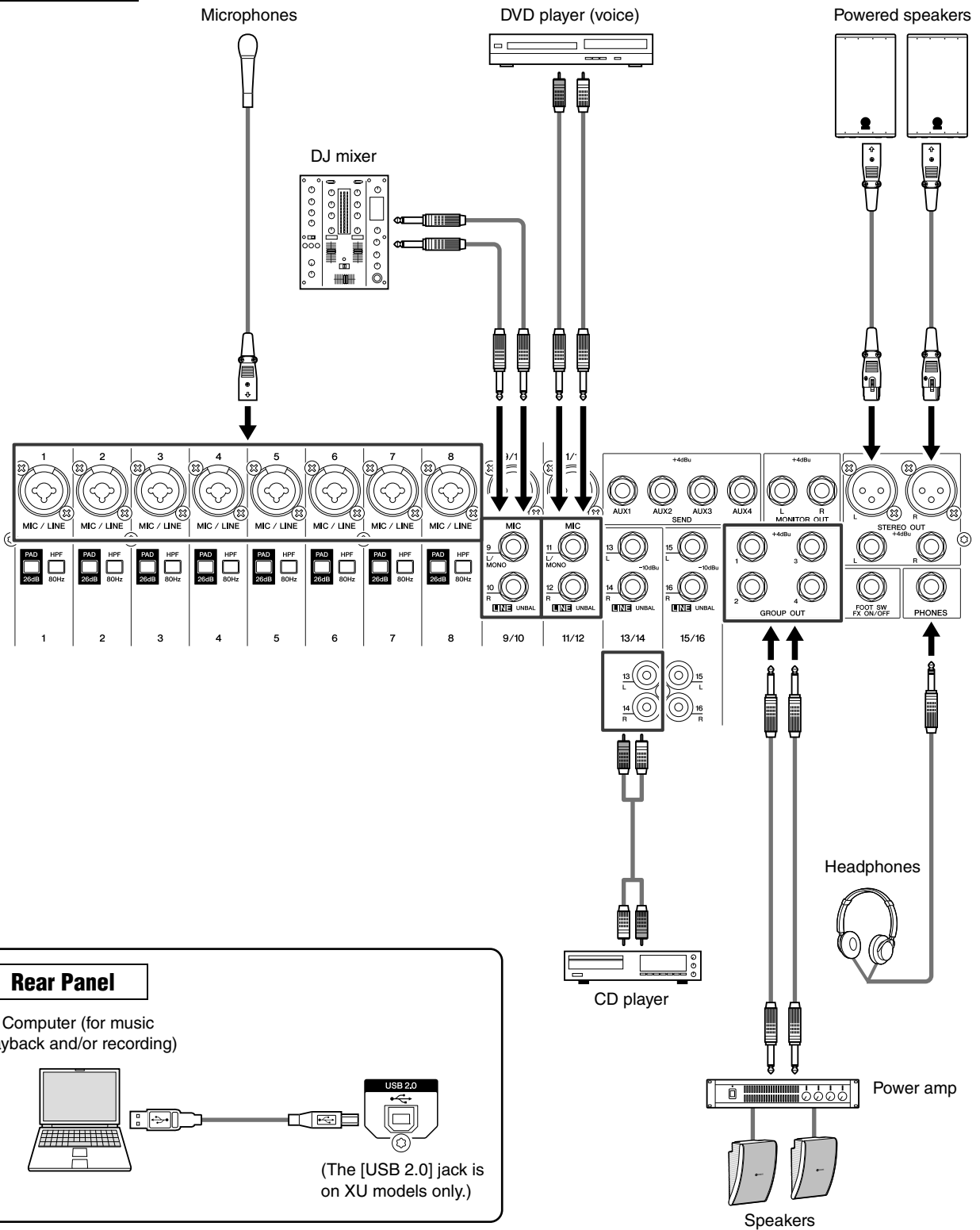

Rear Panel

Computer (for music playback and/or recording)

(The [USB 2.0] jack is on XU models only.)

NOTE
 On the MG20XU/MG20, the [SEND] jack, [GROUP OUT] jack, [MONITOR OUT], jack, and [STEREO OUT] jack are located on the rear panel.

Controls and Connectors

Front Panel

The number and locations of jacks and controls vary slightly by model. Carefully check the name indicated near each jack and control while referring to this manual.

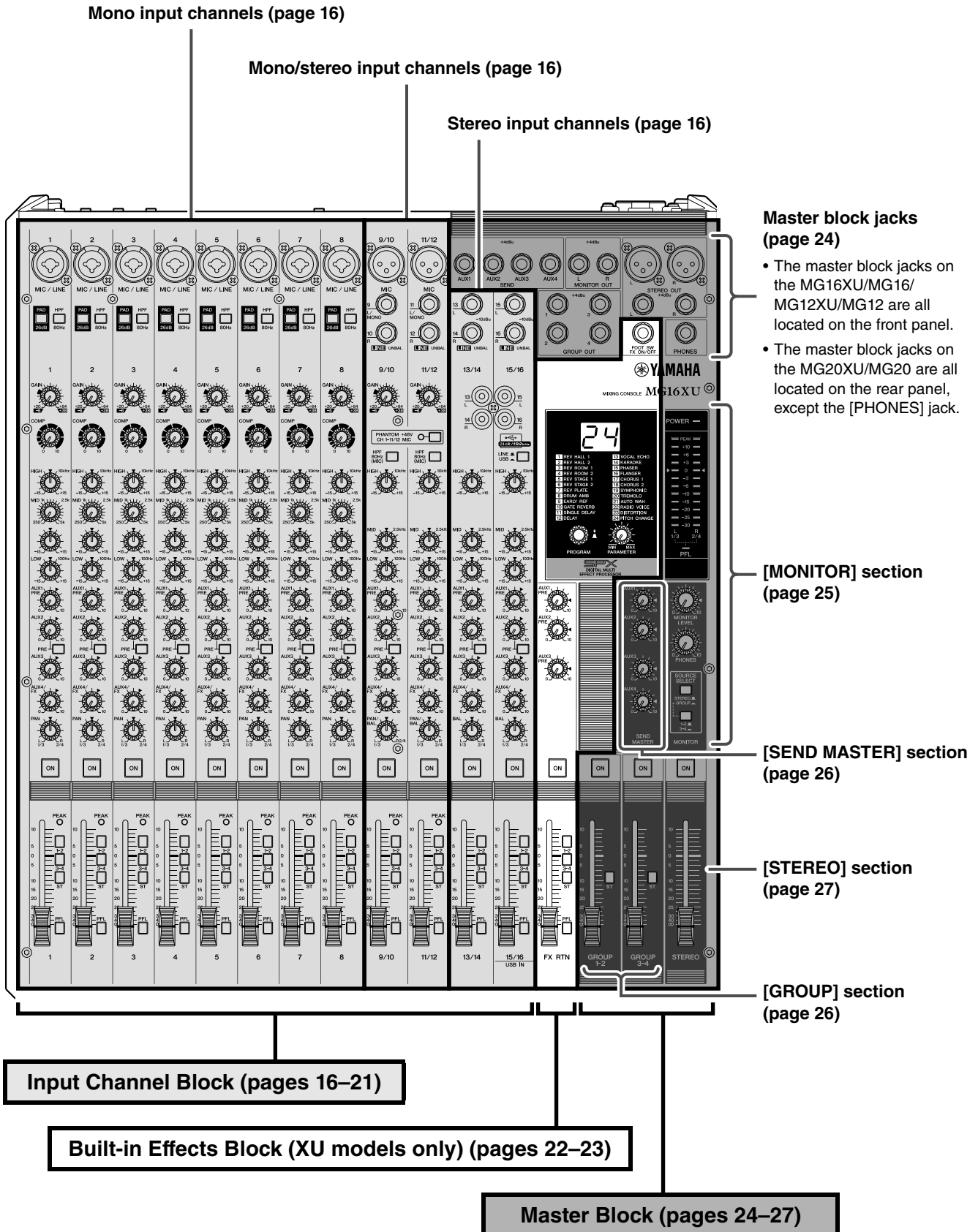

Rear Panel

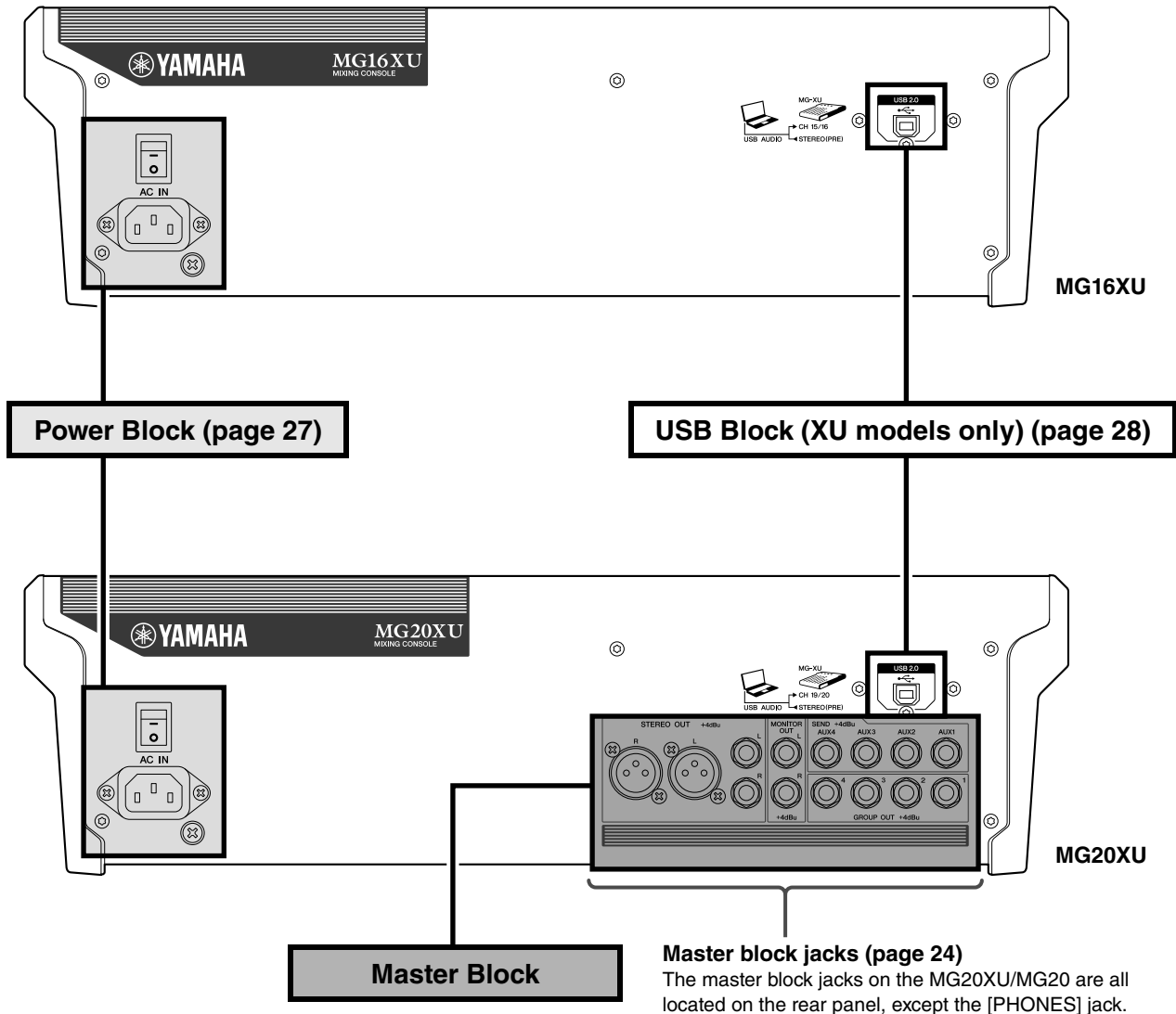

Input Channel Block

Mono input channels	Mono/stereo input channels	Stereo input channels
1 – 12 (MG20XU/MG20)	13/14 – 19/20 (MG20XU/MG20)	
1 – 8 (MG16XU/MG16)	9/10 – 11/12 (MG16XU/MG16)	13/14 – 15/16 (MG16XU/MG16)
1 – 4 (MG12XU/MG12)	5/6 – 7/8 (MG12XU/MG12)	9/10 – 11/12 (MG12XU/MG12)

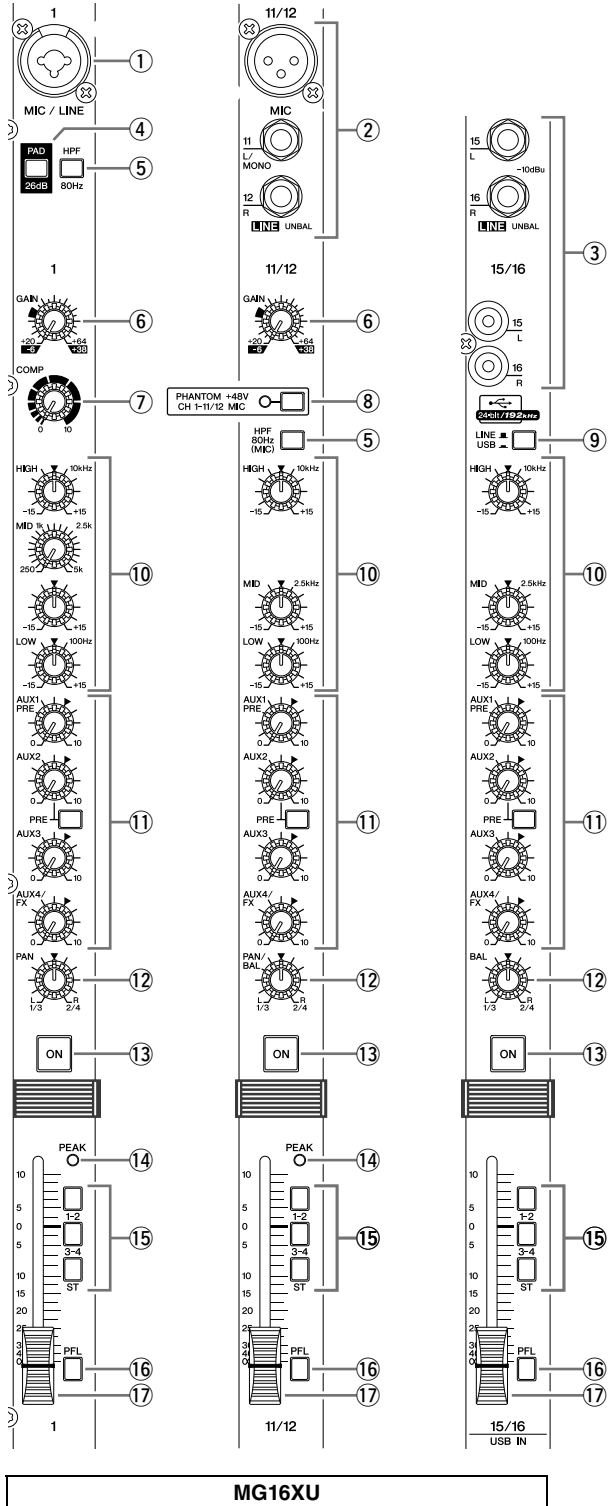

① Mono input jacks

- MG20XU/MG20: 1 – 12
- MG16XU/MG16: 1 – 8
- MG12XU/MG12: 1 – 4

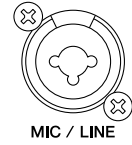

- **[MIC/LINE]:** Accepts both XLR connectors and phone connectors. Connect the microphones and or instruments you intend to use.

② Mono/stereo input jacks

- MG20XU/MG20:
13/14 – 19/20
- MG16XU/MG16:
9/10 – 11/12
- MG12XU/MG12:
5/6 – 7/8

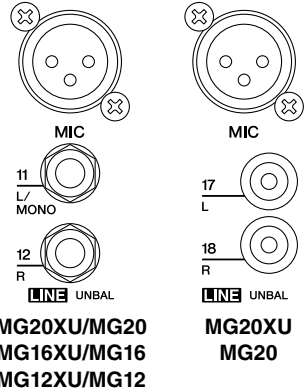

- **[MIC]:** Balanced XLR microphone input jacks (1: ground, 2: hot, 3: cold)
- **[LINE (L/MONO, R)]:** Unbalanced phone type line stereo input jacks (Unbalanced phone-type and RCA stereo input jacks on the MG20XU/MG20)

NOTE

On any given channel, you may use either a phone jack or RCA jack, but not both.

③ Stereo input jacks

- Phone type**
- MG16XU/MG16: 13/14 – 15/16
- MG12XU/MG12: 9/10 – 11/12

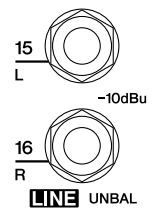

- RCA type**
- MG16XU/MG16: 13/14 – 15/16
- MG12XU/MG12: 9/10 – 11/12

- **LINE [L, R]:** These are stereo input jacks (unbalanced input) for connecting line-level instruments, such as electric keyboards and audio equipment. Two jack types are provided: phone type and RCA pin type.

NOTE

On any given channel, you may use either a phone jack or RCA jack, but not both. If both types of jack are used, only the phone jack will function.

④ [PAD] switch



When this switch is turned on (), the input signal from the [MIC/LINE] jack of the mono input channel is attenuated by 26 dB. Turn this switch off () if you've connected a microphone or other device with a low input level to the channel. Turn it on () if you've connected a line-level device.

NOTE

There may be some noise when operating switches. To prevent this, turn the [ON] switch of a channel off before operating other switches.

⑤ [HPF] (High Pass Filter) switch

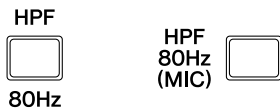

MG20XU/MG20: 1 – 12	13/14 – 19/20
MG16XU/MG16: 1 – 8	9/10 – 11/12
MG12XU/MG12: 1 – 4	5/6 – 7/8

Turning this switch on () will apply a high-pass filter that attenuates frequencies below 80 Hz in the signal by a slope of 12 dB/octave.

NOTE

Turning the [HPF 80Hz (MIC)] switch on will apply a dedicated high-pass filter only to the signal from the [MIC] jacks.

⑥ [GAIN] knobs

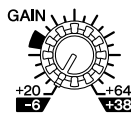

For adjusting the gain of the input signal. Mono input channels have a [PAD] switch ④ that lets you change the range of this control.

The adjustable gain range is as follows.

[PAD] switch	Range
ON	-6 dB to +38 dB
OFF	+20 dB to +64 dB

⑦ [COMP] knobs

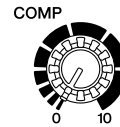

For adjusting the amount of compression applied to the channel. As the [COMP] knob is turned to the right the threshold, ratio, and output gain are adjusted simultaneously.

- **Threshold:** +22 dBu to -8 dBu
- **Ratio:** 1:1 to 4 :1
- **Output gain:** 0 dB to +7 dB
- **Attack time:** Approximately 25 ms
- **Release time:** Approximately 300 ms

NOTE

Avoid setting the compression too high; since the resulting higher average output level may lead to feedback.

⑧ [PHANTOM +48V] switch and indicator

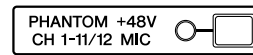

This switch toggles phantom power on and off. Turn this switch on () to supply DC+48 V to the XLR input jacks. The indicator lights when this switch is on. Turn this switch on when using one or more phantom-powered condenser microphones.

NOTICE

- **Be sure to leave this switch off () if you do not need phantom power.**
- **When turning phantom power on (), pay careful attention to the following to prevent damage or noise in the mixing console or connected equipment.**
 - Turn this switch off if equipment that does not use phantom power is connected to the XLR input jacks.
 - Do not disconnect XLR connector cables while this switch is on.
 - Set output controls such as the [STEREO] master fader and the [GROUP] fader to their minimum levels before turning phantom power on or off.

⑨ [LINE /USB] switch (XU models)

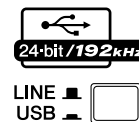

Switches the audio source input on CH19/20 USB IN {CH15/16 USB IN} {CH11/12USB IN} between the [LINE] stereo input jack and the [USB 2.0] jack.

NOTE

The volume input from computers through [USB 2.0] jack can be adjusted by Attenuator Function. Please see Attenuator Function (page 28).

⑩ Equalizer ([HIGH]/[MID]/[LOW])

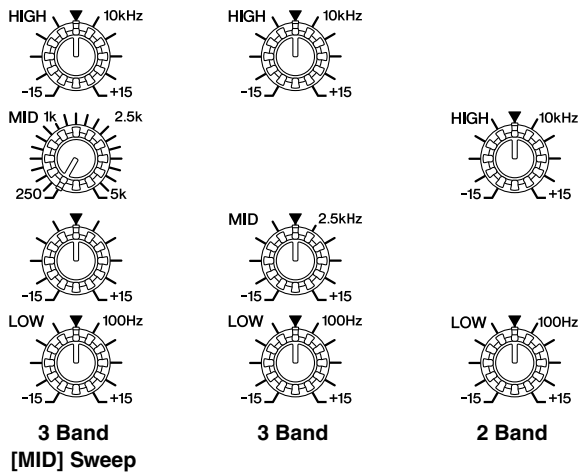

Equalization Types and Characteristics

	3 Band [MID] Sweep	3 Band	2 Band
MG20XU/ MG20	CH 1 – 12	CH 13/14 – 19/20	—
MG16XU/ MG16	CH 1 – 8	CH 9/10 – 15/16	—
MG12XU/ MG12	—	CH 1 – 7/8	CH 9/10 – 11/12

The equalizer shapes the high, mid, and low audio frequencies. Turning the knob to the right amplifies (boosts) the corresponding frequency band, while turning it to the left attenuates (cuts) the band. Setting the knob to the middle “▼” position produces a flat response in the corresponding band. The upper knob sets the variable mid frequency, while the lower knob sets the amount of attenuation or boost (counter-clockwise/clockwise) for the range.

The following table shows the EQ type, frequency, and cut/boost range for each of the three bands.

Band	Type	Frequency	Cut/Boost range
HIGH	Shelving	10 kHz	±15 dB
MID	Peaking	2.5 kHz*	
LOW	Shelving	100 Hz	

* The signals from mono input jacks of the MG20XU/MG20 and MG16XU/MG16 can be adjusted from 250 Hz to 5 kHz.

⑪ [AUX 1 – 4] knobs [PRE] switches [AUX (2, 4)/FX] knobs

- MG20XU/MG16XU: [AUX1], [AUX2 – 3], [AUX4/FX]
- MG20/MG16: [AUX1], [AUX2 – 4]
- MG12XU: [AUX1], [AUX2/FX]
- MG12: [AUX1 – 2]

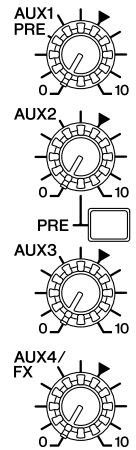

The levels of each signal sent to the AUX 1 – 4 buses from each channel can be adjusted independently. On stereo input channels, the Line L (odd) and Line R (even) input signals are mixed before being sent to each AUX bus. Adjust the knobs so that they are near or at the “▼” (nominal) position.

NOTE

- The [AUX1] knob indicated “PRE” adjusts the level of the pre-fader signal (before fader adjustment).
- The [PRE] switch on [AUX1] and [AUX2] can be used to select whether the pre-fader (▲) (the signal before fader adjustment) or post fader (■) (the signal after fader adjustment) signal is sent to the AUX bus by the [PRE] switch.
- The [AUX4/FX] and [AUX2/FX] knobs are used to adjust the level of the signal sent to the FX bus (built-in effects) in addition to the AUX bus. The same signal level is sent to the AUX buses and FX buses connected to these knobs.

⑫ [PAN] knobs [PAN/BAL] knobs [BAL] knobs

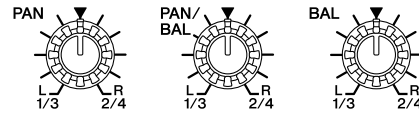

- PAN:** Sets the position of the sound image within the stereo field. This knob adjusts the volume balance of each channel sent to the STEREO L/R bus. When the knob is set to the 12 o'clock position, the channel's sound will be sent to the L and R of the STEREO L/R bus at the same volume. In this case, the sound image is positioned at the center. If the bus assign switch [1-2] or [3-4] is pressed, this knob adjusts the volume balance sent to the GROUP bus. When the knob is set to the 12 o'clock position, the same volume is sent to each GROUP bus. If the knob is turned completely to the left, the signal is sent to the GROUP 1 or GROUP 3 bus only; if the knob is turned completely to the right, the signal is sent to the GROUP 2 or GROUP 4 bus only.

- **BAL:** Sets the volume balance of the signal sent from each stereo input channel (L/R) to the STEREO L/R bus or GROUP bus. When this knob is set to the 12 o'clock position, the sound of the stereo input channels (L/R) will be sent to the STEREO L/R bus or GROUP 1, 3/2, 4 bus at the same volume.

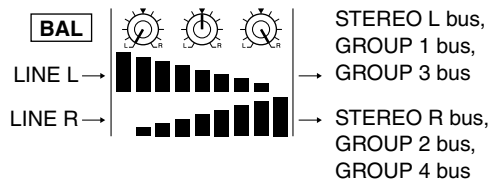

- **PAN/BAL:** This knob performs both [PAN] and [BAL] functions. You can use this as a [PAN] control when sound is input to the [LINE] (L/MONO) jack, and as a [BAL] control when sound is input to both the [LINE] (L) and [LINE] (R) jacks.

13 [ON] switches



Turn this switch on () to send the respective channel's signal to the buses. The switch lights when on. When this switch is off (), the respective signal input is not sent to the AUX bus or GROUP bus.

NOTE

- Even if the [ON] switch is off, the PFL signal from each channel can still be monitored via the [PHONES] jack.
- To minimize noise, turn the [ON] switch off for any unused channels.

14 [PEAK] indicators



The peak level of the post-EQ signal is detected, and the PEAK indicator lights red when the level reaches 3 dB below clipping.

15 Bus assign switch

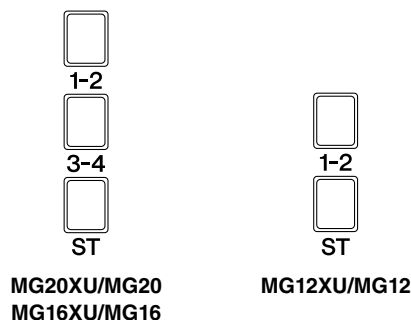

These switches determine the bus(es) to which each channel's signal is sent. Turn the switch on () to output the signal to the corresponding buses.

- **[1-2] switch:** Assigns the channel's signal to the GROUP 1-2 buses.
- **[3-4] switch:** Assigns the channel's signal to the GROUP 3-4 buses.
- **[ST] switch:** Assigns the channel's signal to the STEREO L/R buses.

NOTE

To send the signal to each bus, engage the [ON] switch 13.

16 [PFL] (Pre-fader Listen) switch



When the [PFL] switch is on (), the channel pre-fader signal is output to the [MONITOR OUT] and [PHONES] jacks for monitoring. In this condition, the audio from the STEREO L/R buses or GROUP buses that could be heard in the [MONITOR OUT] and [PHONES] jacks can no longer be heard. When a [PFL] switch is turned on, the [PFL] indicator below the level meter flashes.

17 Channel faders

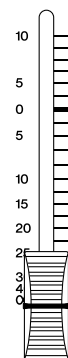

For adjusting the level of the channel signal. Use these controls to adjust the balance between the various channels.

NOTE

To minimize noise, set the fader sliders for any unused channels all the way down.

● Mono input channels

MG20XU/MG20 : CH1-12
 MG16XU/MG16 : CH1-8
 MG12XU/MG12 : CH1-4

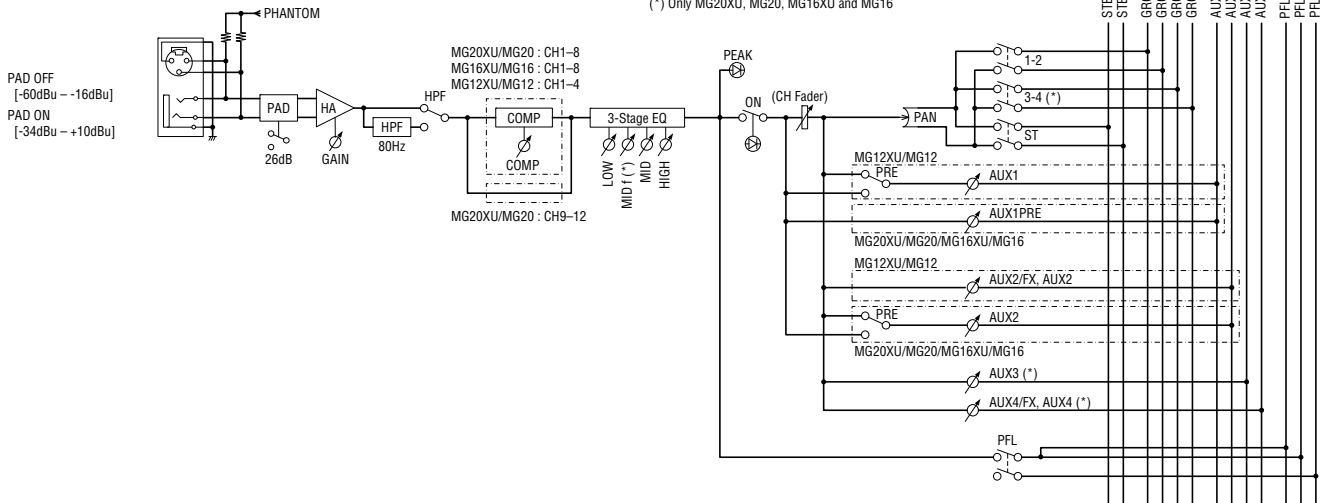

● Mono/stereo input channels

MG20XU/MG20 : CH13/14-19/20
 MG16XU/MG16 : CH9/10,11/12
 MG12XU/MG12 : CH5/6,7/8

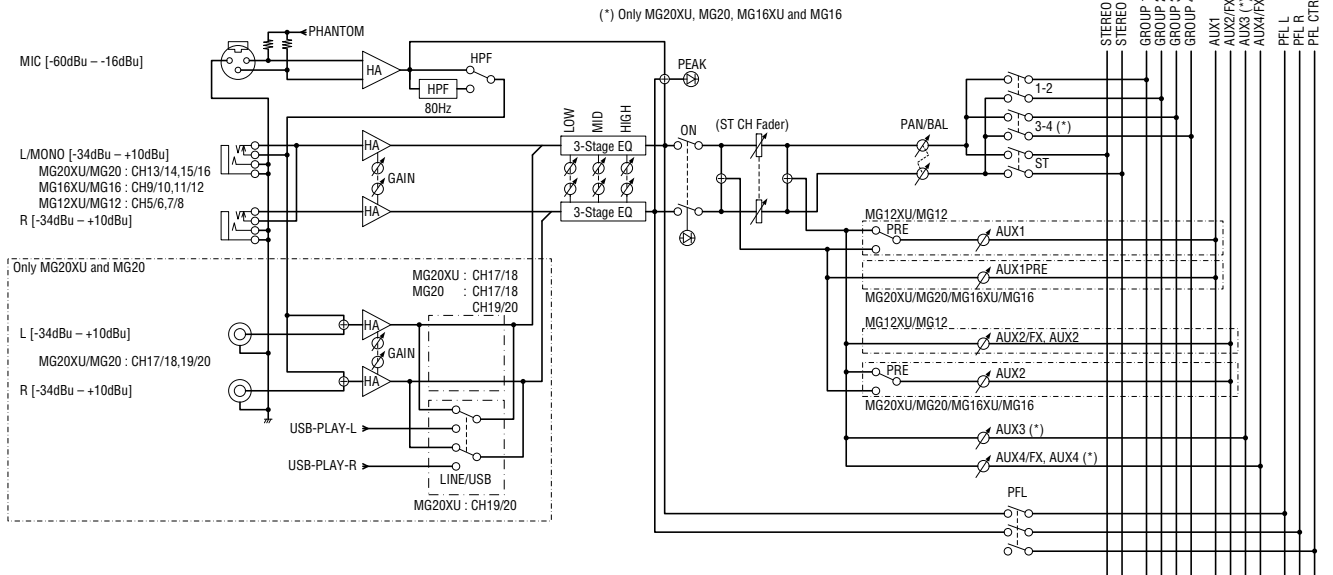

● Stereo input channels

MG16XU/MG16 : CH13/14,15/16
 MG12XU/MG12 : CH9/10,11/12

(*) Only MG16XU and MG16

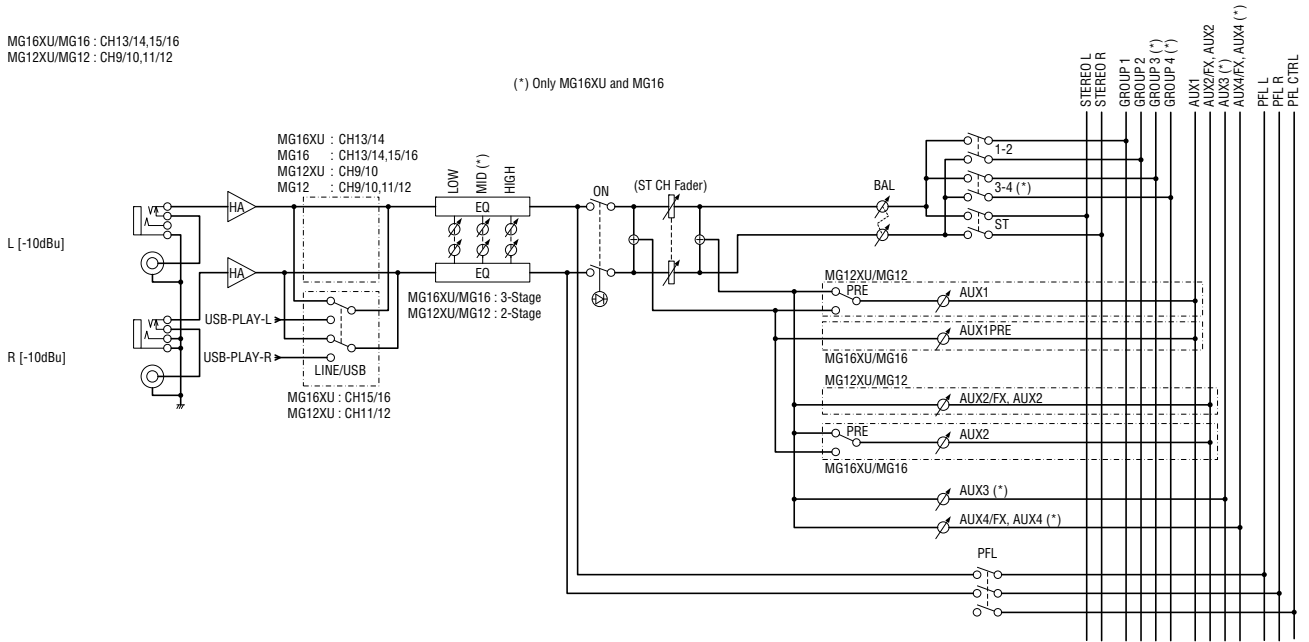

Built-in Effects Block (XU Models Only)

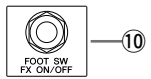
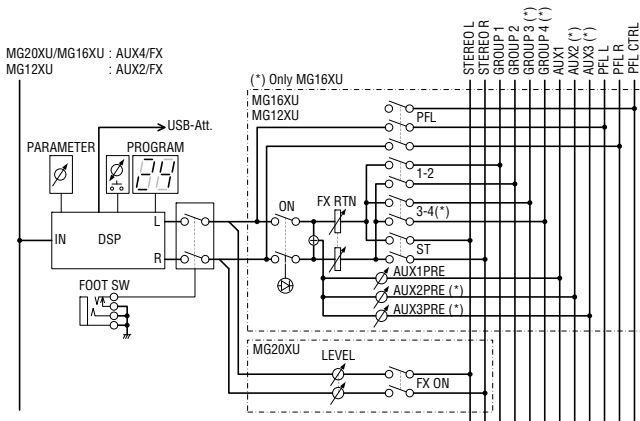

MIXING CONSOLE **MG16XU**

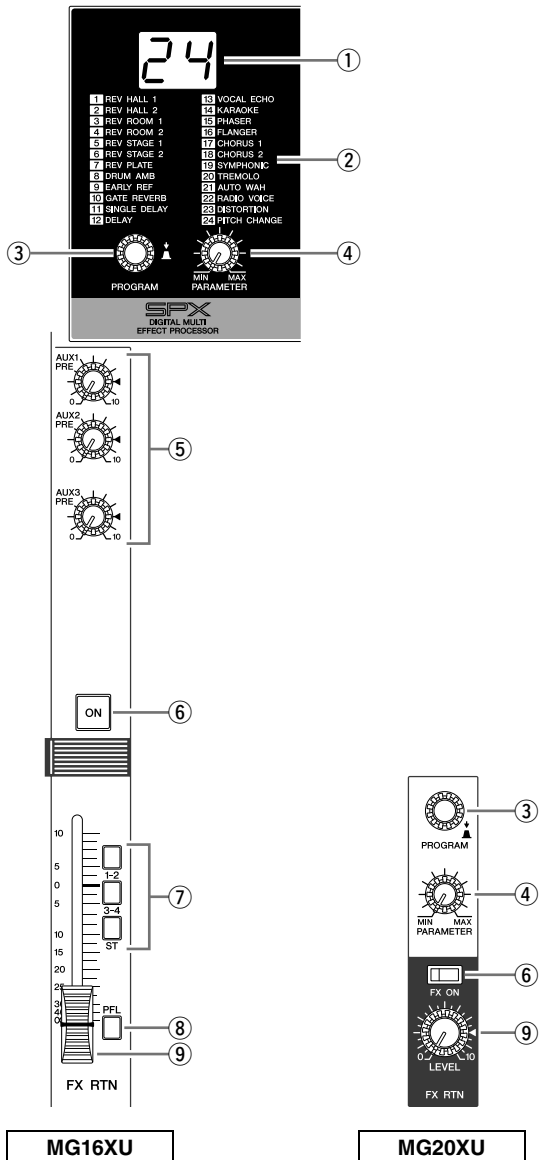

① Display



Indicates the effect program number selected with the [PROGRAM] knob ③. The number flashes during selection; however, if several seconds pass without a selection being made, the program returns to the last number selected.

② Effect program list

1 REV HALL 1	13 VOCAL ECHO
2 REV HALL 2	14 KARAOKE
3 REV ROOM 1	15 PHASER
4 REV ROOM 2	16 FLANGER
5 REV STAGE 1	17 CHORUS 1
6 REV STAGE 2	18 CHORUS 2
7 REV PLATE	19 SYMPHONIC
8 DRUM AMB	20 TREMOLO
9 EARLY REF	21 AUTO WAH
10 GATE REVERB	22 RADIO VOICE
11 SINGLE DELAY	23 DISTORTION
12 DELAY	24 PITCH CHANGE

This is the list of built-in effect programs. For details about these programs, see the “Effect Programs” on page 33.

③ [PROGRAM] knob

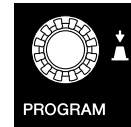

Selects one of the 24 built-in effects. Turn the knob to select the desired effect, and then press the knob to enable it.

NOTE

- You can also select the desired effect by turning the knob while holding it down.
- The [PROGRAM] knob can be used to adjust the volume of audio playback from a computer. For details, see the “Attenuator Function” (page 28).

④ [PARAMETER] knob



For adjusting the parameter (depth, speed, etc.) for the selected effect. The last value used with each effect type is saved.

NOTE

When you change to a different effect type, the mixer automatically restores the value that was previously used with the newly selected effect (regardless of the current position of the [PARAMETER] knob).

⑤ [AUX1 – 3] knobs (MG16XU)
[AUX1] knob (MG12XU)

For adjusting the level of the signal sent from the built-in effect unit to the AUX bus.

NOTE

- The [AUX1] knob indicated "PRE" adjusts the level of the pre-fader signal (before fader adjustment).
- The [FX RTN] fader does not affect the level of the signal sent to the AUX bus.

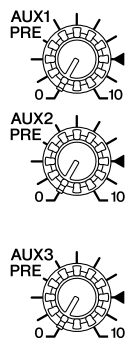

⑥ [FX ON] switch (MG20XU)
[ON] switch (MG16XU/MG12XU)



MG20XU



MG16XU/MG12XU

This button turns the corresponding built-in effect on or off. When the function is on (■), the switch lights.

NOTE

If this switch is on and the foot switch ([FOOT SW] jack ⑩) is used to turn off the built-in effect, the switch flashes.

⑦ Bus assign switch (MG16XU/MG12XU)

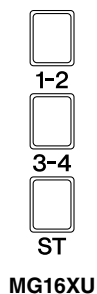

MG16XU

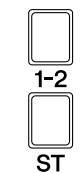

MG12XU

These switches determine the bus(es) to which the signal of the built-in effects is sent. Turn the switch on (■) to output the signal to the corresponding buses.

- [1-2] switch: Assigns to the GROUP 1-2 buses.
- [3-4] switch: Assigns to the GROUP 3-4 buses.
- [ST] switch: Assigns to the STEREO L/R bus.

⑧ [PFL] (Pre-fader Listen) switch (MG16XU/MG12XU)



When the [PFL] switch is on (■), the [FX RTN] pre-fader (MG16XU/MG12XU only) signal is output to the [MONITOR OUT] and [PHONES] jack for monitoring.

⑨ [FX RTN LEVEL] knob (MG20XU)
[FX RTN] fader (MG16XU/MG12XU)



MG20XU

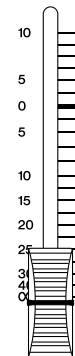

MG16XU/MG12XU

These adjust the level of the effect sent from the built-in effects to the GROUP 1-2 (MG16XU, MG12XU), 3-4 (MG16XU), and STEREO L/R buses.

⑩ [FOOT SW] (Foot Switch) jack



Connect a foot switch to this phone type input jack. An optional Yamaha FC5 foot switch (sold separately) can be used to toggle the effects ON and OFF.

Master Block

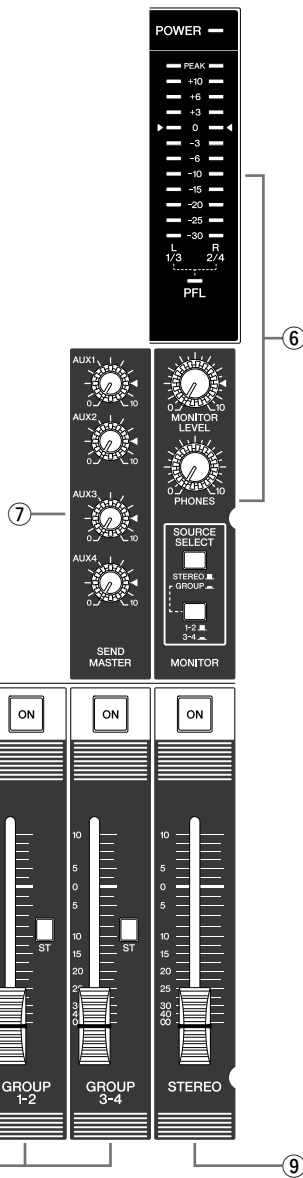
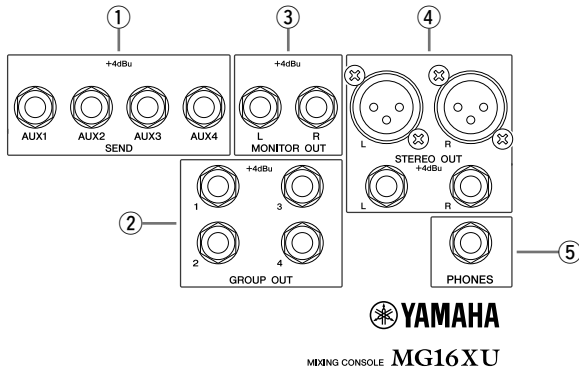

MG16XU

MG20XU Rear Panel

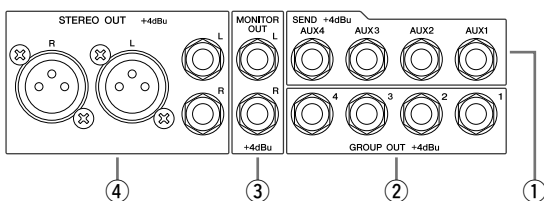

① [SEND] jacks

MG20XU/MG20/MG16XU/MG16: [AUX1 – 4]
 MG12XU/MG12: [AUX1 – 2]

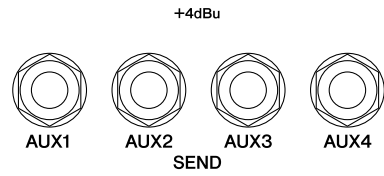

You use these jacks, for example, to connect to an external effect device or a stage/studio monitoring system. These are impedance-balanced* phone-type output jacks.

* Impedance-balanced

Since the hot and cold terminals of impedance-balanced output jacks have the same impedance, these output jacks are less affected by induced noise.

② [GROUP OUT] jacks

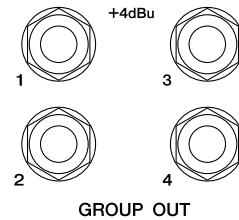

These impedance-balanced TRS phone jacks output the [GROUP 1-2 and 3-4] (MG20XU/MG20/MG16XU/MG16) signals. Use these jacks to connect to the inputs of a multi-track recorder, external mixer, or another similar device.

③ [MONITOR OUT] jacks

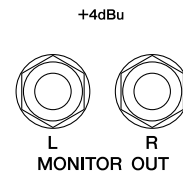

Connect these impedance-balanced TRS phone jacks to your operator monitoring system.

NOTE

When the [PFL] indicator is flashing, the signal for channels where the [PFL] switch is pressed is output. When the [PFL] indicator is off, the signal for the buses selected in the [MONITOR] section ⑥ is output.

④ [STEREO OUT] jacks

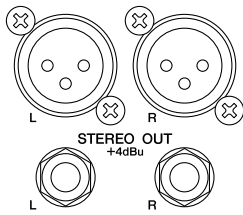

These are XLR type and TRS phone-type balanced output jacks that output the mixed stereo signal. The signal level is adjusted by the [STEREO] master fader before it is output. You can use these jacks, for example, to connect to the power amplifier driving your main speakers.

⑤ [PHONES] jack



Connect a pair of headphones to this TRS phone jack.

NOTE

- The [PHONES] jack outputs the same signal as the [MONITOR OUT] jacks.
- When the [PFL] indicator is flashing, the signal for channels where the [PFL] switch is pressed is output. When the [PFL] indicator is off, the signal for the buses selected in the [MONITOR] section ⑥ is output.

⑥ [MONITOR] section

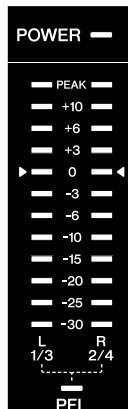
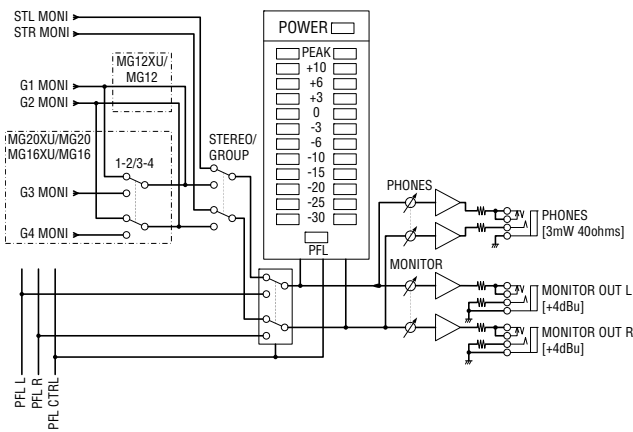

• [POWER] indicator

This indicator lights up when the mixer's power is on ().

• Level meter

The level meter LED shows the level of the signal in the STEREO L/R and GROUP buses, or selected with [PFL] switches. The "0" () segment corresponds to the nominal output level. The level meter [PEAK] indicator lights when output reaches the clipping level.

• [PFL] indicator

When the [PFL] switch is on, the indicator flashes.



MG20XU/MG20
MG16XU/MG16



MG12XU/MG12

• [MONITOR LEVEL] knob

For adjusting the level of the signal output to the [MONITOR OUT] jack.

• [PHONES] knob

For adjusting the level of the signal output to the [PHONES] jack.

• [SOURCE]/[SOURCE SELECT] (Monitor signal selection switch)

Sets the signal sent to the [MONITOR OUT] jack, [PHONES] jack, and level meter. You can use this switch to select the signal from the STEREO L/R buses, GROUP 1-2 buses, or GROUP 3-4 buses (MG20XU/MG20/MG16XU/MG16).

• MG12XU/MG12

STEREO L/R buses: [STEREO] ()
GROUP 1-2 buses: [GROUP] ()

• MG20XU/MG20/MG16XU/MG16

STEREO L/R buses: [STEREO] ()
GROUP 1-2 buses: [GROUP] (), [1-2] ()
GROUP 3-4 buses: [GROUP] (), [3-4] ()

⑦ [SEND MASTER] section

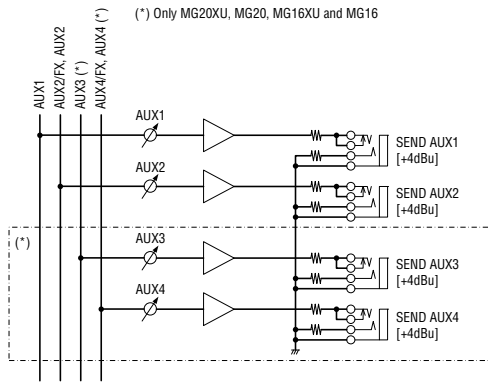

MG20XU/MG20/MG16XU/MG16: [AUX1 – 4] knobs
 MG12XU/MG12: [AUX1 – 2] knobs



MG20XU/MG20
 MG16XU/MG16





MG12XU/
 MG12

For adjusting the levels of the signals output to the [SEND] jacks and [AUX1 – 4].

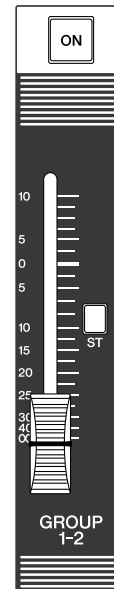
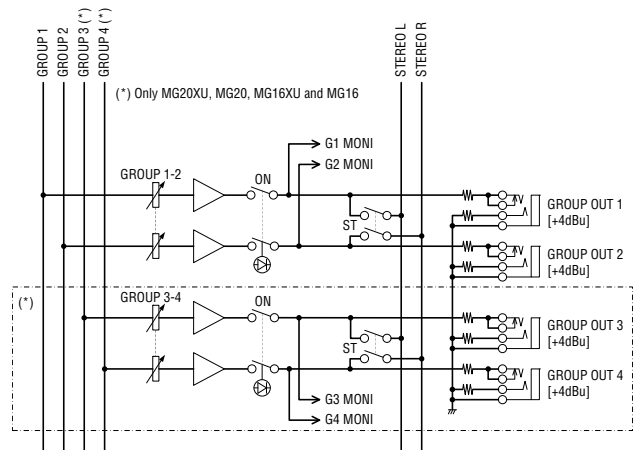
⑧ [GROUP] section



- **[ON] switch**
 Turn this switch on () to activate the [GROUP] fader. The switch lights when on.
- **[GROUP 1-2] fader**
 For adjusting the level of the signal output to the [GROUP OUT 1, 2] jacks.
- **[GROUP 3-4] fader (MG20XU/MG20/MG16XU/ MG16)**
 For adjusting the signal level to the [GROUP OUT 3, 4] jacks.
- **[ST] switch**
 If this switch is on (), the signals are sent to the STEREO L/R bus via the [GROUP 1-2, 3-4] faders. The GROUP 1 and 3 signal goes to the STEREO L bus, and the GROUP 2 and 4 signal goes to the STEREO R bus.

9 [STEREO] section

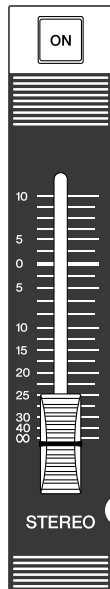
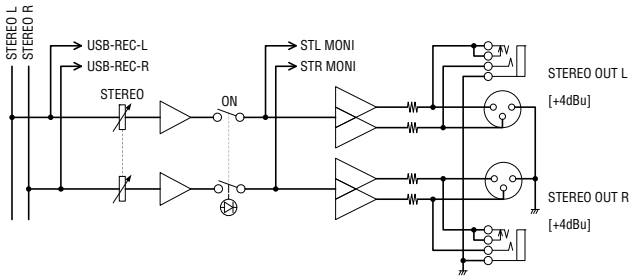

• [ON] switch

Turn this switch on () to enable the [STEREO] master fader. The switch lights when on.

• [STEREO] master fader

For adjusting the level of the signal output to the [STEREO OUT] jack.

Power Block

• [- / O] POWER switch

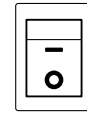

Turns power to the unit on or off. Press the switch to the “ — ” position to turn on the power. Press the switch to the “ O ” position to turn off the power.

NOTICE

- Note that the trace current continues to flow even while the switch is in the off position. If you do not plan to use the mixer for a while, be sure to unplug the power cord from the wall outlet.
- Rapidly turning the unit on and off in succession can cause it to malfunction. After turning the unit off, wait for at least 6 seconds before turning it on again.

• [AC IN] jack

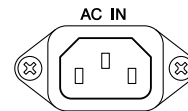

Connect the included power cord here. First, connect the power cord to this unit, and then plug it into an AC outlet.

USB Block (XU Models Only)

only MG20XU/MG16XU/MG12XU

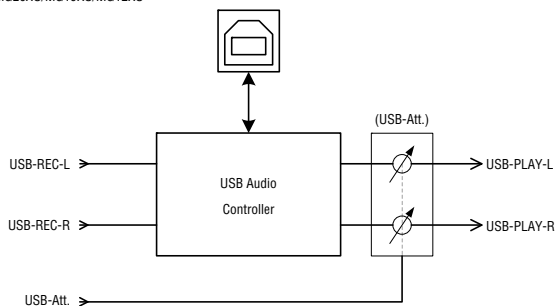

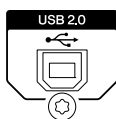

• [USB 2.0] jack



Connects to a computer via a USB cable. The signal from the STEREO L/R buses is output to the computer. (This signal is not affected by the [STEREO] master fader.) A USB driver might be required for computer input/output. You can download the driver from the following Yamaha website, and install it on your computer.

http://www.yamahaproaudio.com/mg_xu

When the [ST] switch of a channel which has a [LINE  / USB ] switch is on while DAW software is being used, a loop is formed and feedback or howling may result.

[USB 2.0] Connection Precautions

Be sure to observe the following points when connecting to a computer's [USB 2.0] interface. Failure to observe these rules can result in computer freezes/hang-ups and possibly data loss or corruption. If the mixer or computer does hang up, restart the application and/or computer and turn the power to the mixer off and then on again.

NOTICE

- Use an A/B type USB cable. The cable should be no more than 1.5 meters long. A USB 3.0 cable cannot be used.
- Be sure to wake the computer from sleep/suspended/standby mode before making a connection to the computer's [USB 2.0] connector.
- Connect the mixer to the computer before turning the mixer power on.
- Always perform the following two operations before turning the mixer's power on or off, or connecting or disconnecting the USB cable.
 - Exit all applications.
 - Confirm that no data is being sent from the mixer.
- Allow at least six (6) seconds between turning the mixer on or off, and plugging or unplugging the USB cable.

■ Attenuator Function

The [PROGRAM] knob ③ (page 22) can be used to adjust the volume of audio playback from a computer.

1. Press the [PROGRAM] knob five times consecutively to display the attenuation value (dB).
2. Turn the [PROGRAM] knob to set it between -24 dB to 0 dB. (The minus sign is not displayed.)
3. Press the [PROGRAM] knob again to exit the setting.

When the attenuator is enabled, the dot lights at the lower right of the display.

Troubleshooting

When No Sound Is Output

Refer to this section when no sound is output or the volume is very low. This information is for when sound is output from the [STEREO OUT] jacks or the [PHONES] jack.

For details about these functions, see “Controls and Connectors” on pages 14 – 28.

■ STEP 1 Connections and Signal Flow

Check if the instruments, microphones, and speakers are connected correctly, and if any of the cables are damaged.

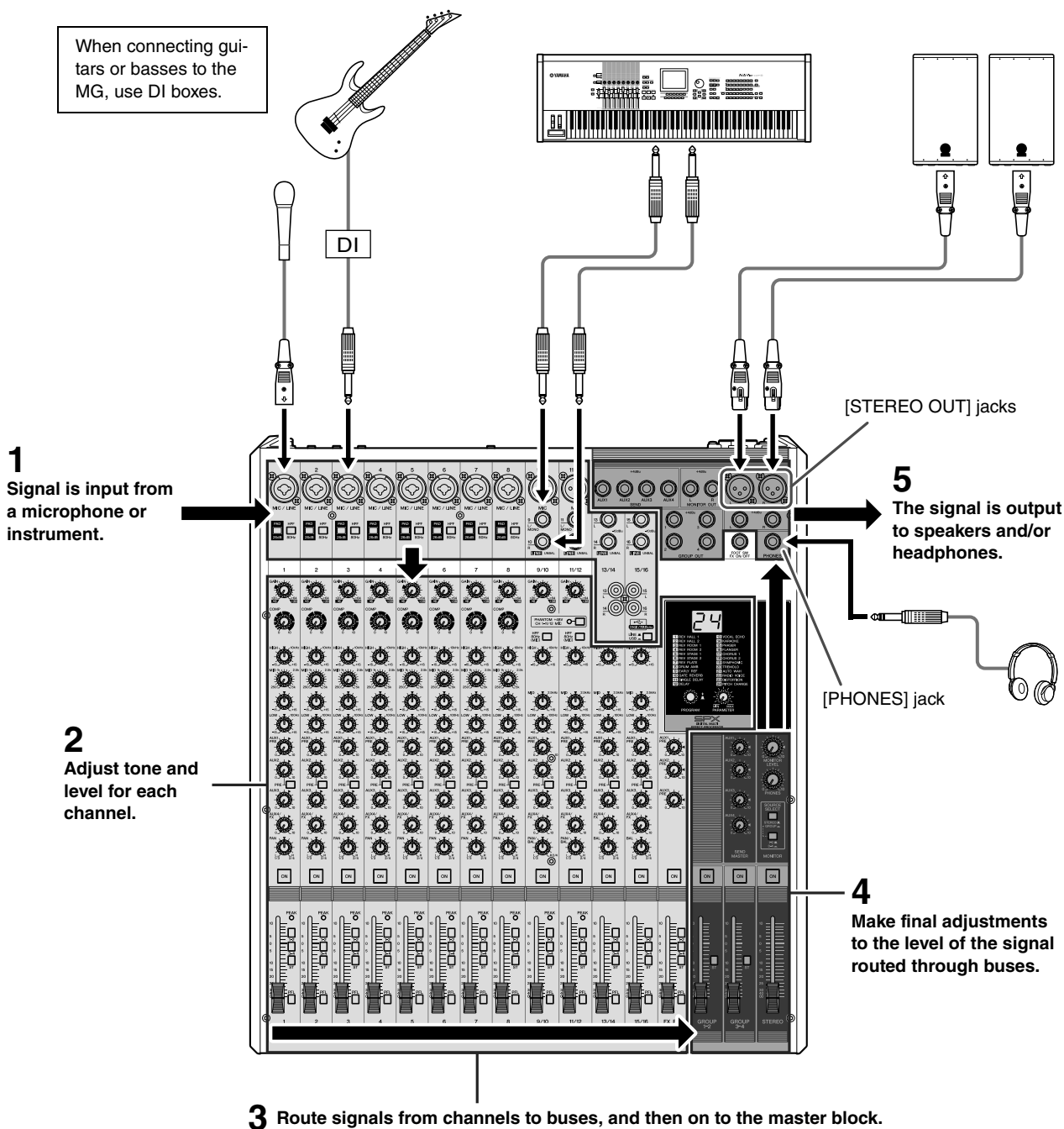

■ STEP 2 Setting Switches and Controls

Check the overall balance

Use the settings shown in the illustration to check the overall balance from speakers or headphones.

[GAIN] knobs
Turn until the [PEAK] indicator begins to flash intermittently.

[PHANTOM +48V] switch
Turn this switch on (the indicator lit) when using a condenser microphone.
• To prevent an unwanted burst of noise from the speakers, turn off powered speakers (or power amps) before turning on the [PHANTOM +48V] switch.

Level meter
If the level meter [PEAK] indicator flashes frequently, lower the faders for each channel.

[PHONES] knob
For adjusting the headphone level.

[SOURCE]/[SOURCE SELECT] (Monitor signal selection switch)
Use to monitor the sound via the level meter and/or headphones.
• **MG12XU/MG12**
STEREO L/R buses: [STEREO] ()
GROUP 1-2 buses: [GROUP] ()
• **MG20XU/MG20/MG16XU/MG16**
STEREO L/R buses: [STEREO] ()
GROUP 1-2 buses: [GROUP] (),
[1-2] ()
GROUP 3-4 buses: [GROUP] (),
[3-4] ()

[STEREO] master fader
For adjusting the overall volume, with "0" as the nominal level.

[PFL] switches
All off ()
• When [PFL] switches are on, only the signals from those channels are sent to the level meter and headphones. Therefore, you will be unable to check the overall sound.
• If the [PFL] indicator below the level meter is flashing, one or more [PFL] switches are on.

Channel faders
For adjusting the level for each channel.

[ON] switches
On (lit)

[PEAK] indicators

[ST] switches
On ()

To monitor the signal of each channel

You can use the level meter and headphones to check the pre-fader signal for each channel.

- **[PFL] switches:** Turn on () for the channel(s) you want to check.
- **[MONITOR LEVEL] knob:** Adjust the level.

Other

<p>■ The power does not come on.</p>	<p><input type="checkbox"/> Is the mixer connected to an independent power source (generator, etc.) or a power strip with switches? Check that the power of that device is turned on.</p>
<p>■ No sound is output.</p>	<p><input type="checkbox"/> Are external instruments (including microphones) and speakers connected correctly? <input type="checkbox"/> Are your cables shorted? <input type="checkbox"/> Are the [GAIN] knobs for each channel, channel faders, [STEREO] master fader, and [GROUP] faders adjusted to appropriate levels? <input type="checkbox"/> Are the bus assign switches and [LINE  /USB ] switch set appropriately?</p>
<p>■ No sound is output from the [STEREO OUT] jack.</p>	<p><input type="checkbox"/> Are the [ON] switch and [ST] switch for the channels you are using turned on? <input type="checkbox"/> Is the [STEREO] master [ON] switch turned on?</p>
<p>■ No sound is output from the [SEND (AUX1 – 4)] jacks</p>	<p><input type="checkbox"/> Are the [SEND MASTER] knobs and [AUX 1 – 4] for each channel set appropriately? <input type="checkbox"/> Are the [ON] switches for the channels you are using turned on?</p>
<p>■ No sound is output from the [MONITOR OUT] jack or [PHONES] jack.</p>	<p><input type="checkbox"/> Are the [PFL] switches for the channels you are not using turned on? Turn the [PFL] switches off.</p>
<p>■ The sound is low, distorted, or noisy.</p>	<p><input type="checkbox"/> Is the microphone connected to a [MIC] jack or a [MIC/LINE] jack? <input type="checkbox"/> When using a condenser microphone, is the [PHANTOM +48V] switch turned on? <input type="checkbox"/> Is the [PAD] switch on? Turn this switch off for sources with low output levels, such as microphones. <input type="checkbox"/> Is the output signal level for the instrument connected to the mixer appropriate? <input type="checkbox"/> When connecting an instrument with an output level of +4 dBu, either turn on the [PAD] switch on a mono input channel or use a stereo input channel. <input type="checkbox"/> Where an input channel provides both a XLR input jack and a phone input jack, or a phone input jack and an RCA pin jack, are there connections made at both jacks? Use only one of these jacks. <input type="checkbox"/> Are the [GAIN] knobs for each channel, channel faders, [STEREO] master fader, and [GROUP] faders adjusted to appropriate levels? <input type="checkbox"/> Are effect or compressor levels too high? Use the [FX] knob, [FX RTN] fader, [FX RTN LEVEL] knob, and [COMP] knob to lower their levels.</p>
<p>■ Effects are not applied.</p>	<p><input type="checkbox"/> Are the [FX] knobs for each channel adjusted to appropriate levels? <input type="checkbox"/> Is the [ON] button for [FX RTN] turned on? <input type="checkbox"/> Are the [PARAMETER] knob and [FX RTN] fader adjusted to appropriate levels? <input type="checkbox"/> Is the [FX RTN] bus assign switch set appropriately? <input type="checkbox"/> If external effects are connected to the [SEND(AUX1 – 4)] jacks, are the [AUX1 – 4] knobs for [SEND MASTER] set appropriately?</p>
<p>■ Speaking voices are not clear.</p>	<p><input type="checkbox"/> Is the [HPF] switch turned on? <input type="checkbox"/> Is the equalizer ([HIGH]/[MID]/[LOW]) adjusted appropriately?</p>
<p>■ No mixer monitor signal is output.</p>	<p><input type="checkbox"/> Are powered speakers connected to the [MONITOR OUT] jacks? Use the [MONITOR LEVEL] knob to adjust the signal output from the [MONITOR OUT] jacks.</p>
<p>■ Left and right levels are different for a stereo signal input.</p>	<p><input type="checkbox"/> Is [PAN] set to the center? If panned to the center, try reversing the left and right input connections. If, after switching the left and right connections, the side with the low volume level also switches, check the instrument or device that is the source of the signal. <input type="checkbox"/> Are you using the same type of cable to connect both the left and right input signals? Cables with built-in resistors will attenuate the signal.</p>
<p>■ The sound level is unstable and inconsistent.</p>	<p><input type="checkbox"/> Is the compressor level set too high? Use the [COMP] knob to lower the level.</p>
<p>■ The volume of audio playback from a computer need to be adjusted.</p>	<p><input type="checkbox"/> Use the “Attenuator Function”. For details, see page 28.</p>

If any specific problem should persist, please contact your Yamaha dealer.

Appendix

General Specifications

0 dBu = 0.775 Vrms, Output impedance of signal generator (Rs) = 150 Ω
All level controls are nominal if not specified.

		MG12XU MG12	MG16XU MG16	MG20XU MG20
Input channels	Mono: MIC/LINE	4	8	12
	Mono/Stereo: MIC/LINE	2	2	4
	Stereo: LINE	2	2	0
Output channels	STEREO OUT	2		
	MONITOR OUT	1		
	PHONES	1		
	AUX SEND	2	4	4
	GROUP OUT	2	4	4
Bus	STEREO	1	1	1
	GROUP	2	4	4
	AUX	2 (MG12XU: incl. FX)	4 (MG16XU: incl. FX)	4 (MG20XU: incl. FX)
Input Channel Function	PAD	26 dB		
	HPF	80 Hz, 12 dB/oct (Mono/Stereo: MIC only)		
	COMP	1 knob compressor (Gain/Threshold/Ratio) Threshold: +22 dBu to -8 dBu, Ratio: 1:1 to 4:1, Output level: 0 dB to 7 dB Attack time: approx. 25 msec, Release time: approx. 300 msec		
	EQ	HIGH: Gain: +15 dB/-15 dB, Frequency: 10 kHz shelving		
		MID: Gain: +15 dB/-15 dB Frequency: 2.5 kHz peaking	MID: Gain: +15 dB/-15 dB Frequency: Mono 250 Hz – 5 kHz peaking Stereo 2.5 kHz peaking	
PEAK LED	LED turns on when post EQ signal reaches 3 dB below clipping level			
Level Meter	Pre Monitor LEVEL	2 × 12 -segment LED meter [PEAK, +10, +6, +3, 0, -3, -6, -10, -15, -20, -25, -30 dB]		
Built-in Effect (XU Models)	SPX Algorithm	24 programs, PARAMETER control: 1, FOOT SW: 1 (FX RTN CH on/off)		
USB Audio (XU Models)	2 IN / 2 OUT	USB Audio Class 2.0 compliant, Sampling Frequency: Max 192 kHz, Bit Depth: 24-bit		
Phantom Power Voltage		+48 V		
Power Requirements		AC 100 – 240 V, 50 / 60 Hz		
Power Consumption		22 W	30 W	36 W
Dimensions (W × H × D)		308 mm × 118 mm × 422 mm (12.1" × 4.6" × 16.6")	444 mm × 130 mm × 500 mm (17.5" × 5.1" × 19.7")	444 mm × 130 mm × 500 mm (17.5" × 5.1" × 19.7")
Net Weight		MG12XU: 4.2 kg (9.3 lbs) MG12: 4.0 kg (8.8 lbs)	MG16XU: 6.8 kg (15.0 lbs) MG16: 6.6 kg (14.6 lbs)	MG20XU: 7.1 kg (15.7 lbs) MG20: 6.9 kg (15.2 lbs)
Included Accessory		Owner's Manual, Technical Specifications, Cubase AI Download Information (XU models) Rack-Mount Kit (MG20XU, MG20, MG16XU, MG16), AC Power Cord		
Optional Accessory		Rack-Mount Kit: RK-MG12 (MG12XU, MG12), Foot Switch: FC5 (XU models)		
Operating Temperature		0 to +40°C		

For other specifications, see the included "Technical Specifications."

The contents of this manual apply to the latest specifications as of the publishing date. To obtain the latest manual, access the Yamaha website then download the manual file.

European Models



Inrush Current based on EN 55103-1:2009
3.0 A (on initial switch-on)
2.0 A (after a supply interruption of 5s)
Conforms to Environments: E1, E2, E3 and E4

Effect Programs

No.	Program	Parameter	Description
1	REV HALL 1	Reverb Time	Reverb simulating a large space such as a concert hall.
2	REV HALL 2	Reverb Time	
3	REV ROOM 1	Reverb Time	Reverb simulating the acoustics of a small space (room).
4	REV ROOM 2	Reverb Time	
5	REV STAGE 1	Reverb Time	Reverb simulating a large stage.
6	REV STAGE 2	Reverb Time	
7	REV PLATE	Reverb Time	Simulation of a metal-plate reverb unit, producing a more hard-edged reverberation.
8	DRUM AMB	Reverb Time	A short reverb that is ideal for use with a drum kit.
9	EARLY REF	Room Size	An effect which isolates only the early reflection components from reverberation, creating a 'flashier' effect than conventional reverb.
10	GATE REV	Room Size	An effect which cuts halfway the tail-end of the reverberation, making a more powerful sound.
11	SINGLE DLY	Delay Time	An effect which repeats the same sound only once. Shortening the delay time produces a doubling effect.
12	DELAY	Delay Time	Feedback delay adding multiple delayed signals.
13	VOCAL ECHO	Delay Time	Echo designed for conventional vocals.
14	KARAOKE	Delay Time	Echo designed for karaoke (sing-along) applications.
15	PHASER	LFO* Freq	Cyclically changes the phase to add modulation to the sound.
16	FLANGER	LFO* Freq	Adds modulation to the sound, producing an effect similar to the rise and fall sound of a jet engine.
17	CHORUS 1	LFO* Freq	Creates a thicker ensemble-like sound by adding the multiple sounds with different delay times.
18	CHORUS 2	LFO* Freq	
19	SYMPHONIC	LFO* Depth	Multiplies the sound for thicker texture.
20	TREMOLO	LFO* Freq	An effect which cyclically modulates the volume.
21	AUTO WAH	LFO* Freq	A wah-wah effect with cyclical filter modulation. The [PARAMETER] knob adjusts the speed of the LFO* that modulates the "wah" filter.
22	RADIO VOICE	Cutoff Offset	Recreates the lo-fi sound of an AM radio. The [PARAMETER] knob adjusts the frequency band to be emphasized.
23	DISTORTION	Drive	Adds a sharp-edged distortion to the sound.
24	PITCH CHANGE	Pitch	An effect which changes the pitch of the signal.

* "LFO" stands for Low Frequency Oscillator. An LFO is normally used to periodically modulate another signal, using different waveform shapes and modulation speeds.

Jack and Connector List

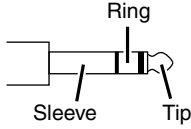
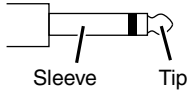
Jacks and Connectors	Polarities	Configurations
MIC/LINE, MIC, STEREO OUT	Pin 1: Ground Pin 2: Hot (+) Pin 3: Cold (-)	<div style="display: flex; justify-content: space-around;"> <div style="text-align: center;"> <p>INPUT</p>  </div> <div style="text-align: center;"> <p>OUTPUT</p>  </div> </div> <p style="text-align: center;">XLR Jack</p>
MIC/LINE*, AUX SEND, GROUP OUT, MONITOR OUT, STEREO OUT	Tip: Hot (+) Ring: Cold (-) Sleeve: Ground	 <p style="text-align: center;">TRS Phone Connector</p>
PHONES	Tip: L Ring: R Sleeve: Ground	
LINE (stereo input channels)	Tip: Hot Sleeve: Ground	 <p style="text-align: center;">TS Phone Connector</p>

* These jacks also can be connected with TS phone connectors. If you use TS phone connectors, the connection will be unbalanced.

Connector Types

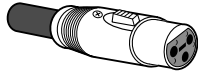
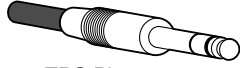
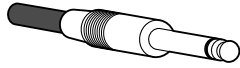
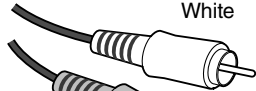
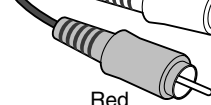
<p>XLR</p> <p>This 3-pin connector is resistant to externally induced noise, and is used primarily for balanced connections. With properly designed receiving circuitry, cables with this type of connector can also be used for unbalanced signals. XLR type connectors are the standard for microphone connections as well as most professional audio gear.</p>	 <p>Male</p>  <p>Female</p>
<p>Phone</p> <p>Phone connectors are available in TRS and TS types. TRS types are used for stereo headphone jacks, insert jacks, and also for carrying balanced signals in many cases. TS types are used to carry unbalanced signals -for example, electric guitar cables.</p>	 <p>TRS Phone</p>  <p>TS Phone</p>
<p>RCA Pin</p> <p>This type of unbalanced connector is most commonly found on home audio and video equipment. RCA type pin jacks are often color coded: white for left audio channel and red for right audio channel, for example.</p>	 <p>White</p>  <p>Red</p>

Rack Mounting

The MG12XU/MG12 require at least 10 U* of rack space. To take into account the cable connections, we recommend to ensure 11 U* of rack space. The MG20XU/MG20/MG16XU/MG16 require at least 12 U* of rack space. To take into account the cable connections, we recommend to ensure 14 U* of rack space.

* 10 U is approximately 445 mm, 11 U is approximately 489 mm, 12 U is approximately 533 mm, and 14 U is approximately 623 mm.

■ Precautions for Rack Mounting

- This unit is rated for operation at ambient temperatures ranging from 0 to 40 degrees Celsius. If you install this unit along with other devices in a poorly ventilated rack, the ambient temperature inside the rack may rise, resulting in inefficient performance. Be sure to rack-mount in the following conditions so the unit does not overheat.
 - When mounting the unit in a rack with devices such as power amplifiers that generate a significant amount of heat, leave more than 1 U of space between the MG and other equipment. Also, either leave the open spaces uncovered or install appropriate ventilating panels to minimize the possibility of heat buildup.
 - To ensure sufficient airflow, leave the rear of the rack open and position it at least 10 centimeters from walls or other surfaces. If the rear of the rack cannot be left open, install a commercially available fan or similar ventilating option to secure sufficient airflow. If you've installed a fan kit, there may be cases in which closing the rear of the rack will produce a greater cooling effect. Refer to the rack and/or fan unit manual for details.

	Rack-Mount Kit	Right and Left Designation of Rack-Mount Kit
MG20XU/MG20	Accessories	—
MG16XU/MG16	Accessories	—
MG12XU/MG12	Option sold separately Model Name: RK-MG12	Indicated L/R (Locate the bracket designated 'L' on the left, and the bracket designated 'R' on the right)

■ Mounting Procedures

(The illustration shows the MG12XU.)

1. Use a screwdriver to loosen the screws on the sides of the mixer (six total).

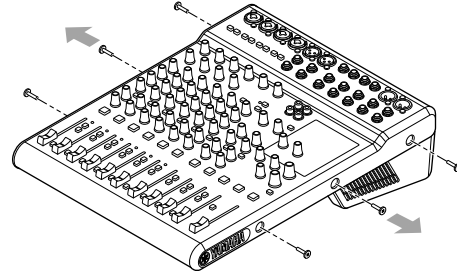

2. Use the screws removed in Step 1 to install the rack-mount kit (included with MG20XU/MG20/MG16XU/MG16, optional RK-MG12 for the MG12XU/MG12 sold separately) on the mixer.

NOTICE

Be sure to use the screws removed in Step 1. Using other screws can cause damage.

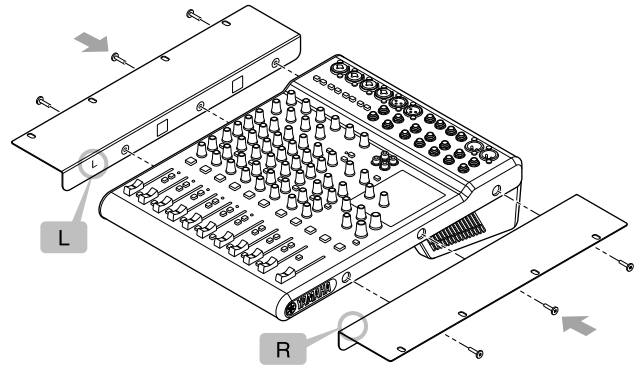

3. Mount the unit into the rack, and fasten it into place.

⚠ CAUTION

This unit is heavy, and should be lifted by two people when mounting it into a rack.

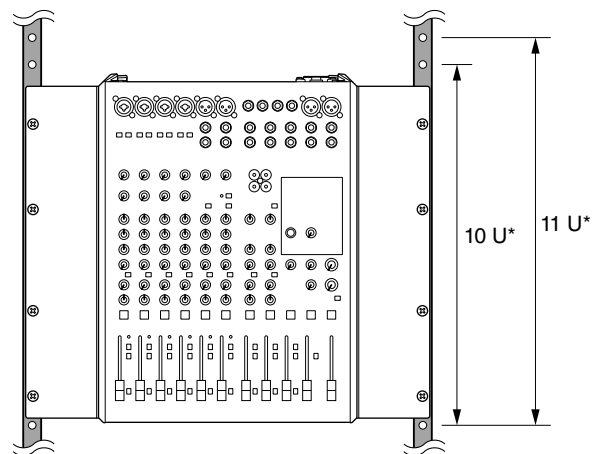

* The MG20XU/MG20/MG16XU/MG16 require at least 12 U of rack space. To take into account the cable connections, we recommend to ensure 14 U of rack space.

Index

Numerics

- [1-2] switch19, 23
- [3-4] switch19, 23

A

- [AC IN] jack27
- Attenuator Function28
- [AUX1] knob23
- [AUX1 – 3] knob23
- [AUX1 – 4] knob18
- [AUX (2, 4)/FX] knob18

B

- [BAL] knob18
- Bus assign switch19, 23

C

- [COMP] knob17

D

- DI (direct box)29
- D-PRE8

E

- Effect program list22
- Equalizer ([HIGH]/[MID]/[LOW])18

F

- [FOOT SW] (Foot Switch) jack23
- [FX ON] switch23
- [FX RTN] fader23
- [FX RTN LEVEL] knob23

G

- [GAIN] knob17
- [GROUP] section26
- [GROUP 1-2] fader26
- [GROUP 3-4] fader26
- [GROUP OUT] jack24

H

- [HPF] (High Pass Filter) switch17

L

- Level meter25
- [LINE /USB 

M

- [MIC/LINE]16
- [MONITOR] section25
- [MONITOR LEVEL] knob25
- [MONITOR OUT] jack24
- Mono input jack16
- Mono/stereo input jack16

O

- [ON] switch 19, 23, 26, 27

P

- [PAD] switch 17
- [PAN] knob 18
- [PAN/BAL] knob 18
- [PARAMETER] knob 23
- [PEAK] indicator 19
- Peaking 18
- [PFL] indicator 25
- [PFL] (Pre-fader Listen) switch 10, 19, 23
- [PHANTOM +48V] switch and indicator 17
- Phone 34
- [PHONES] jack 25
- [PHONES] knob 25
- [–/○] POWER switch 27
- [PRE] switch 18
- [PROGRAM] knob 22

R

- Rack-Mount Kit 35
- RCA Pin 34
- Reverb and Delay Time 11

S

- [SEND] jack 24
- [SEND MASTER] section 26
- Shelving 18
- [SOURCE]/[SOURCE SELECT] 25
- [ST] switch 19, 23, 26
- Stereo input jack 16
- [STEREO] master fader 27
- [STEREO] section 27
- [STEREO OUT] jack 25

U

- [USB 2.0] jack 28

X

- XLR 34

MEMO

Important Notice: Guarantee Information for customers in European Economic Area (EEA) and Switzerland

<p>Important Notice: Guarantee Information for customers in EEA* and Switzerland</p> <p>For detailed guarantee information about this Yamaha product, and Pan-EEA* and Switzerland warranty service, please either visit the website address below (Printable file is available at our website) or contact the Yamaha representative office for your country. * EEA: European Economic Area</p>	English
<p>Wichtiger Hinweis: Garantie-Information für Kunden in der EWR* und der Schweiz</p> <p>Für nähere Garantie-Information über dieses Produkt von Yamaha, sowie über den Pan-EWR*- und Schweizer Garantieservice, besuchen Sie bitte entweder die folgend angegebene Internetadresse (eine druckfähige Version befindet sich auch auf unserer Webseite), oder wenden Sie sich an den für Ihr Land zuständigen Yamaha-Vertrieb. *EWR: Europäischer Wirtschaftsraum</p>	Deutsch
<p>Remarque importante: informations de garantie pour les clients de l'EEE et la Suisse</p> <p>Pour des informations plus détaillées sur la garantie de ce produit Yamaha et sur le service de garantie applicable dans l'ensemble de l'EEE ainsi qu'en Suisse, consultez notre site Web à l'adresse ci-dessous (le fichier imprimable est disponible sur notre site Web) ou contactez directement Yamaha dans votre pays de résidence. * EEE : Espace Economique Européen</p>	Français
<p>Belangrijke mededeling: Garantie-informatie voor klanten in de EER* en Zwitserland</p> <p>Voor gedetailleerde garantie-informatie over dit Yamaha-product en de garantieservice in heel de EER* en Zwitserland, gaat u naar de onderstaande website (u vindt een afdrukbaar bestand op onze website) of neemt u contact op met de vertegenwoordiging van Yamaha in uw land. * EER: Europese Economische Ruimte</p>	Nederlands
<p>Aviso importante: información sobre la garantía para los clientes del EEE* y Suiza</p> <p>Para una información detallada sobre este producto Yamaha y sobre el soporte de garantía en la zona EEE* y Suiza, visite la dirección web que se incluye más abajo (la versión del archivo para imprimir esta disponible en nuestro sitio web) o póngase en contacto con el representante de Yamaha en su país. * EEE: Espacio Económico Europeo</p>	Español
<p>Avviso importante: informazioni sulla garanzia per i clienti residenti nell'EEA* e in Svizzera</p> <p>Per informazioni dettagliate sulla garanzia relativa a questo prodotto Yamaha e l'assistenza in garanzia nei paesi EEA* e in Svizzera, potete consultare il sito Web all'indirizzo riportato di seguito (è disponibile il file in formato stampabile) oppure contattare l'ufficio di rappresentanza locale della Yamaha. * EEA: Area Economica Europea</p>	Italiano
<p>Aviso importante: informações sobre as garantias para clientes da AEE* e da Suíça</p> <p>Para obter uma informação pormenorizada sobre este produto da Yamaha e sobre o serviço de garantia na AEE* e na Suíça, visite o site a seguir (o arquivo para impressão está disponível no nosso site) ou entre em contato com o escritório de representação da Yamaha no seu país. * AEE: Área Económica Européia</p>	Português
<p>Σημαντική σημείωση: Πληροφορίες εγγύησης για τους πελάτες στον ΕΟΧ* και Ελλάδα</p> <p>Για λεπτομερείς πληροφορίες εγγύησης σχετικά με το παρόν προϊόν της Yamaha και την κάλυψη εγγύησης σε όλες τις χώρες του ΕΟΧ και την Ελλάδα, επισκεφτείτε την παρακάτω ιστοσελίδα (Εκτυπώσιμη μορφή είναι διαθέσιμη στην ιστοσελίδα μας) ή απευθυνθείτε στην αντιπροσωπεία της Yamaha στη χώρα σας. * ΕΟΧ: Ευρωπαϊκός Οικονομικός Χώρος</p>	Ελληνικά
<p>Viktigt: Garantiinformation för kunder i EES-området* och Schweiz</p> <p>För detaljerad information om denna Yamahaprodukt samt garantiservice i hela EES-området* och Schweiz kan du antingen besöka nedanstående webbadress (en utskriftsvänlig fil finns på webbplatsen) eller kontakta Yamahas officiella representant i ditt land. * EES: Europeiska Ekonomiska Samarbetsområdet</p>	Svenska
<p>Viktig merknad: Garantiinformasjon for kunder i EØS* og Sveits</p> <p>Detaljert garantiinformasjon om dette Yamaha-produktet og garantiservice for hele EØS-området* og Sveits kan fås enten ved å besøke nettstedene nedenfor (utskriftsversjon finnes på våre nettsider) eller kontakte Yamahas kontoret i landet der du bor. *EØS: Det europeiske økonomiske samarbeidsområdet</p>	Norsk
<p>Vigtig oplysning: Garantioplysninger til kunder i EØ* og Schweiz</p> <p>De kan finde detaljerede garantioplysninger om dette Yamaha-produkt og den fælles garantiserviceordning for EØ* (og Schweiz) ved at besøge det websted, der er angivet nedenfor (der findes en fil, som kan udskrives, på vores websted), eller ved at kontakte Yamahas nationale repræsentationskontor i det land, hvor De bor. * EØ: Det Europæiske Økonomiske Område</p>	Dansk
<p>Tärkeä ilmoitus: Takuutiedot Euroopan talousalueen (ETA)* ja Sveitsin asiakkaille</p> <p>Tämän Yamaha-tuotteen sekä ETA-alueen ja Sveitsin takuuta koskevat yksityiskohtaiset tiedot saatte alla olevasta nettiosoitteesta. (Tulostettava tiedosto saatavissa sivustollamme.) Voitte myös ottaa yhteyttä paikalliseen Yamaha-edustajaan. *ETA: Euroopan talousalue</p>	Suomi
<p>Ważne: Warunki gwarancyjne obowiązujące w EOG* i Szwajcarii</p> <p>Aby dowiedzieć się więcej na temat warunków gwarancyjnych tego produktu firmy Yamaha i serwisu gwarancyjnego w całym EOG* i Szwajcarii, należy odwiedzić wskazaną poniżej stronę internetową (Plik gotowy do wydruku znajduje się na naszej stronie internetowej) lub skontaktować się z przedstawicielstwem firmy Yamaha w swoim kraju. * EOG — Europejski Obszar Gospodarczy</p>	Polski
<p>Důležité oznámení: Záruční informace pro zákazníky v EHS* a ve Švýcarsku</p> <p>Podrobné záruční informace o tomto produktu Yamaha a záručním servisu v celém EHS* a ve Švýcarsku naleznete na níže uvedené webové adrese (soubor k tisku je dostupný na našich webových stránkách) nebo se můžete obrátit na zástupce firmy Yamaha ve své zemi. * EHS: Evropský hospodářský prostor</p>	Česky
<p>Fontos figyelemztetés: Garancia-információk az EGT* területén és Svájcban élő vásárlók számára</p> <p>A jelen Yamaha termékre vonatkozó részletes garancia-információk, valamint az EGT*-re és Svájcra kiterjedő garanciális szolgáltatás tekintetében keresse fel webhelyünket az alábbi címen (a webhelyen nyomtatható fájl is talál), vagy pedig lépjen kapcsolatba az országában működő Yamaha képviselői irodával. * EGT: Európai Gazdasági Térség</p>	Magyar
<p>Oluline märkus: Garantiiteave Euroopa Majanduspiirkonna (EMP)* ja Šveitsi klientidele</p> <p>Täpsema teabe saamiseks selle Yamaha toote garantii ning kogu Euroopa Majanduspiirkonna ja Šveitsi garantiiteeninduse kohta, külastage palun veebisaiti alljärgneval aadressil (meie saidil on saadaval prinditav fail) või pöörduge Teie regiooni Yamaha esinduse poole. * EMP: Euroopa Majanduspiirkond</p>	Eesti keel
<p>Svarīgs paziņojums: garantijas informācija klientiem EEZ* un Šveicē</p> <p>Lai saņemtu detalizētu garantijas informāciju par šo Yamaha produktu, kā arī garantijas apkalpošanu EEZ* un Šveicē, lūdzu, apmeklējiet zemāk norādīto tīmekļa vietnes adresi (tīmekļa vietnē ir pieejams drukājams fails) vai sazinieties ar jūsu valsti apkalpojošo Yamaha pārstāvnīcību. * EEZ: Eiropas Ekonomikas zona</p>	Latviešu
<p>Démesio: informacija dėl garantijos pirkėjams EEE* ir Šveicarijoje</p> <p>Jei reikia išsamios informacijos apie šį „Yamaha“ produktą ir jo techninę priežiūrą visoje EEE* ir Šveicarijoje, apsilankykite mūsų svetainėje toliau nurodytu adresu (svetainėje yra spausdintinas failas) arba kreipkitės į „Yamaha“ atstovybę savo šaliai. *EEE – Europos ekonominė erdvė</p>	Lietuvių kalba
<p>Dôležité upozornenie: Informácie o záruke pre zákazníkov v EHP* a Švajčiarsku</p> <p>Podrobné informácie o záruke týkajúce sa tohto produktu od spoločnosti Yamaha a garančnom servise v EHP* a Švajčiarsku nájdete na webovej stránke uvedenej nižšie (na našej webovej stránke je k dispozícii súbor na tlač) alebo sa obráťte na zástupcu spoločnosti Yamaha vo svojej krajine. * EHP: Európsky hospodársky priestor</p>	Slovenčina
<p>Pomembno obvestilo: Informacije o garanciji za kupce v EGP* in Švici</p> <p>Za podrobnejše informacije o tem Yamahinem izdelku ter garancijskem servisu v celotnem EGP in Švici, obiščite spletno mesto, ki je navedeno spodaj (natisljiva datoteka je na voljo na našem spletnem mestu), ali se obrnite na Yamahinega predstavnika v svoji državi. * EGP: Evropski gospodarski prostor</p>	Slovenščina
<p>Важно съобщение: Информация за гаранцията за клиенти в ЕИП* и Швейцария</p> <p>За подробна информация за гаранцията за този продукт на Yamaha и гаранционното обслужване в паневропейската зона на ЕИП* и Швейцария или посетете посочения по-долу уеб сайт (на нашия уеб сайт има файл за печат), или се свържете с представителния офис на Yamaha във вашата страна. * ЕИП: Европейско икономическо пространство</p>	Български език
<p>Notificarea importantă: Informații despre garanție pentru clienții din SEE* și Elveția</p> <p>Pentru informații detaliate privind acest produs Yamaha și serviciul de garanție Pan-SEE* și Elveția, vizitați site-ul la adresa de mai jos (fișierul imprimabil este disponibil pe site-ul nostru) sau contactați biroul reprezentanței Yamaha din țara dumneavoastră. * SEE: Spațiul Economic European</p>	Limba română

<http://europe.yamaha.com/warranty/>

ADDRESS LIST

NORTH AMERICA

CANADA

Yamaha Canada Music Ltd.
135 Milner Avenue, Toronto, Ontario,
M1S 3R1, Canada
Tel: +1-416-298-1311

U.S.A.

Yamaha Corporation of America
6600 Orangethorpe Avenue, Buena Park, CA 90620,
U.S.A.
Tel: +1-714-522-9011

CENTRAL & SOUTH AMERICA

MEXICO

Yamaha de México, S.A. de C.V.
Av. Insurgentes Sur 1647 Piso 9, Col. San José
Insurgentes, Delegación Benito Juárez, México,
D.F., C.P. 03900
Tel: +52-55-5804-0600

BRAZIL

Yamaha Musical do Brasil Ltda.
Rua Fidêncio Ramos, 302 – Cj 52 e 54 – Torre B – Vila
Olimpia – CEP 04551-010 – São Paulo/SP, Brazil
Tel: +55-11-3704-1377

ARGENTINA

**Yamaha Music Latin America, S.A.,
Sucursal Argentina**
Olga Cossetini 1553, Piso 4 Norte,
Madero Este-C1107CEK,
Buenos Aires, Argentina
Tel: +54-11-4119-7000

VENEZUELA

Yamaha Musical de Venezuela, C.A.
AV. Manzanares, C.C. Manzanares Plaza,
Piso 4, Oficina 0401, Baruta, Caracas, Venezuela
Tel: +58-212-943-1877

PANAMA AND OTHER LATIN AMERICAN COUNTRIES/ CARIBBEAN COUNTRIES

Yamaha Music Latin America, S.A.
Edif. Torre Banco General, Piso 7, Urbanización
Marbella, Calle 47 y Aquilino de la Guardia,
Ciudad de Panamá, República de Panamá
Tel: +507-269-5311

EUROPE

THE UNITED KINGDOM/IRELAND

Yamaha Music Europe GmbH (UK)
Sherbourne Drive, Tilbrook, Milton Keynes,
MK7 8BL, U.K.
Tel: +44-1908-366700

GERMANY

Yamaha Music Europe GmbH
Siemensstrasse 22-34, 25462 Rellingen, Germany
Tel: +49-4101-303-0

SWITZERLAND/LIECHTENSTEIN

**Yamaha Music Europe GmbH, Rellingen,
Branch Switzerland in Zürich**
Seefeldstrasse 94, 8008 Zürich, Switzerland
Tel: +41-44-3878080

AUSTRIA/BULGARIA

Yamaha Music Europe GmbH Branch Austria
Schleiergasse 20, 1100 Wien, Austria
Tel: +43-1-60203900

CZECH REPUBLIC/HUNGARY/ ROMANIA/SLOVAKIA/SLOVENIA

**Yamaha Music Europe GmbH
Branch Austria**
Schleiergasse 20, 1100 Wien, Austria
Tel: +43-1-60203900

POLAND/LITHUANIA/LATVIA/ESTONIA

Yamaha Music Europe GmbH
Sp.z o.o. Oddzial w Polsce
ul. Wrotkowa 14, 02-553 Warsaw, Poland
Tel: +48-22-880-08-88

MALTA

Olimpus Music Ltd.
Valletta Road, Mosta MST9010, Malta
Tel: +356-2133-2093

NETHERLANDS/BELGIUM/ LUXEMBOURG

Yamaha Music Europe Branch Benelux
Clarissenhof 5b, 4133 AB Vianen, The Netherlands
Tel: +31-347-358040

FRANCE

Yamaha Music Europe
7 rue Ambroise Croizat, Zone d'activités de Pariest,
77183 Croissy-Beaubourg, France
Tel: +33-1-6461-4000

ITALY

Yamaha Music Europe GmbH, Branch Italy
Viale Italia 88, 20020, Lainate (Milano), Italy
Tel: +39-02-93577-1

SPAIN/PORTUGAL

**Yamaha Music Europe GmbH Ibérica, Sucursals
en España**
Ctra. de la Coruna km. 17,200, 28231
Las Rozas de Madrid, Spain
Tel: +34-91-639-88-88

GREECE

Philippos Nakas S.A. The Music House
19th klm. Leof. Lavriou 190 02 Peania – Attiki,
Greece
Tel: +30-210-6686168

SWEDEN/FINLAND/ICELAND

**Yamaha Music Europe GmbH Germany filial
Scandinavia**
JA Wettergrensgata 1, 400 43 Göteborg, Sweden
Tel: +46-31-89-34-00

DENMARK

**Yamaha Music Denmark,
Fillial of Yamaha Music Europe GmbH, Tyskland**
Generatorvej 8C, ST. TH. , 2860 Soborg, Denmark
Tel: +45-44-92-49-00

NORWAY

**Yamaha Music Europe GmbH Germany -
Norwegian Branch**
Grini Næringspark 1, 1332 Østerås, Norway
Tel: +47-6716-7800

RUSSIA

Yamaha Music (Russia) LLC.
Room 37, entrance 7, bld. 7, Kievskaya street,
Moscow, 121059, Russia
Tel: +7-495-626-5005

OTHER EUROPEAN COUNTRIES

Yamaha Music Europe GmbH
Siemensstrasse 22-34, 25462 Rellingen, Germany
Tel: +49-4101-3030

AFRICA

Yamaha Music Gulf FZE
JAFZA-16, Office 512, P.O.Box 17328,
Jebel Ali FZE, Dubai, UAE
Tel: +971-4-801-1500

MIDDLE EAST

TURKEY

**Yamaha Music Europe GmbH
Merkezi Almanya Türkiye İstanbul Şubesi**
Maslak Meydan Sodak, Spring Giz Plaza Bagimsiz
Böl. No:3, Sariyer Istanbul, Turkey
Tel: +90-212-999-8010

CYPRUS

Yamaha Music Europe GmbH
Siemensstrasse 22-34, 25462 Rellingen, Germany
Tel: +49-4101-303-0

OTHER COUNTRIES

Yamaha Music Gulf FZE
JAFZA-16, Office 512, P.O.Box 17328,
Jebel Ali FZE, Dubai, UAE
Tel: +971-4-801-1500

ASIA

THE PEOPLE'S REPUBLIC OF CHINA

Yamaha Music & Electronics (China) Co.,Ltd.
2F, Yunhedasha, 1818 Xinzha-lu, Jingan-qu,
Shanghai, China
Tel: +86-400-051-7700

INDIA

Yamaha Music India Private Limited
Spazedge Building, Ground Floor, Tower A,
Sector-47, Gurgaon- Sohna Road, Gurgaon-122002,
Haryana, India
Tel: +91-124-485-3300

INDONESIA

PT. Yamaha Musik Indonesia (Distributor)
Yamaha Music Center Bldg. Jalan Jend. Gatot
Subroto Kav. 4, Jakarta 12930, Indonesia
Tel: +62-21-520-2577

KOREA

Yamaha Music Korea Ltd.
8F, Dongsung Bldg. 21, Teheran-ro 87-gil,
Gangnam-gu, Seoul, 135-880, Korea
Tel: +82-2-3467-3300

MALAYSIA

Yamaha Music (Malaysia) Sdn. Bhd.
No.8, Jalan Perbandaran, Kelana Jaya, 47301
Petaling Jaya, Selangor, Malaysia
Tel: +60-3-78030900

SINGAPORE

Yamaha Music (Asia) Private Limited
Block 202 Hougang Street 21, #02-00,
Singapore 530202, Singapore
Tel: +65-6740-9200

TAIWAN

Yamaha Music & Electronics Taiwan Co.,Ltd.
2F., No.1, Yuandong Rd. Banqiao Dist.
New Taipei City 22063, Taiwan, R.O.C.
Tel: +886-2-7741-8888

THAILAND

Siam Music Yamaha Co., Ltd.
3, 4, 15, 16th Fl., Siam Motors Building,
891/1 Rama 1 Road, Wangmai,
Pathumwan, Bangkok 10330, Thailand
Tel: +66-2215-2622

VIETNAM

Yamaha Music Vietnam Company Limited
15th Floor, Nam A Bank Tower, 201-203 Cach
Mang Thang Tam St., Ward 4, Dist.3,
Ho Chi Minh City, Vietnam
Tel: +84-8-3818-1122

OTHER ASIAN COUNTRIES

**Yamaha Corporation
Sales & Marketing Division**
10-1, Nakazawa-cho, Naka-ku, Hamamatsu,
Japan 430-8650
Tel: +81-53-460-2312

OCEANIA

AUSTRALIA

Yamaha Music Australia Pty. Ltd.
Level 1, 99 Queensbridge Street, Southbank,
VIC 3006, Australia
Tel: +61-3-9693-5111

COUNTRIES AND TRUST TERRITORIES IN PACIFIC OCEAN

**Yamaha Corporation
Sales & Marketing Division**
10-1, Nakazawa-cho, Naka-ku, Hamamatsu,
Japan 430-8650
Tel: +81-53-460-2312

Yamaha Pro Audio global website
<http://www.yamahaproaudio.com/>
Yamaha Downloads
<http://download.yamaha.com/>

Manual Development Group
© 2014 Yamaha Corporation

Published 08/2016 POLE** -01E0
Printed in Malaysia

ZT44570