

APPLICATION CASE STUDY

PREDICTIVE MAINTENANCE OF MOBILE MACHINERY USING FLOW CONDITION MONITORING



NORMAL OPERATION - 5 SECOND LIFT
- 60 BAR PRESSURE

FAULTY OPERATION - 10 SECOND LIFT
- 60 BAR PRESSURE

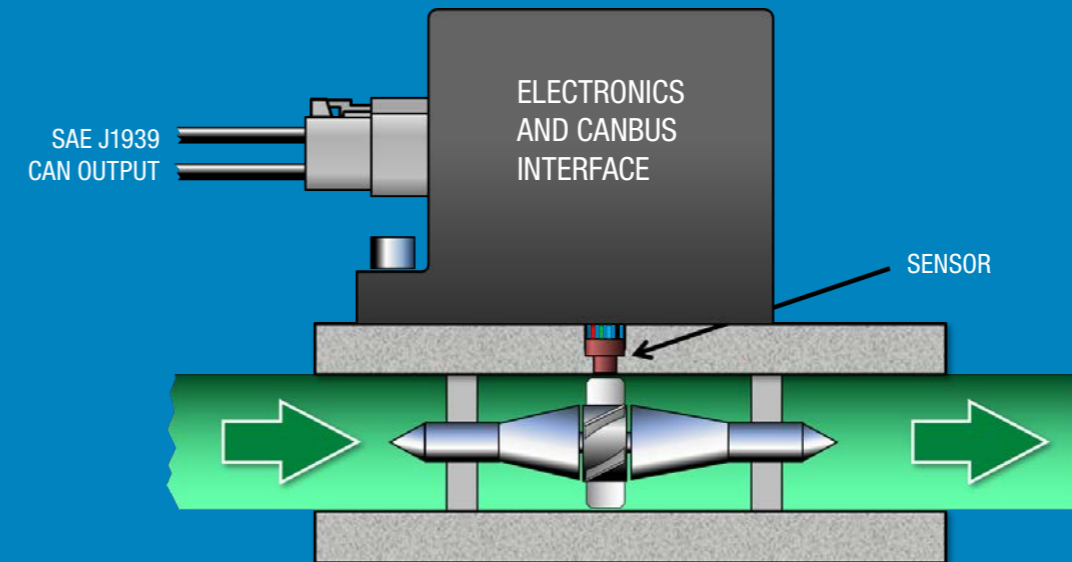
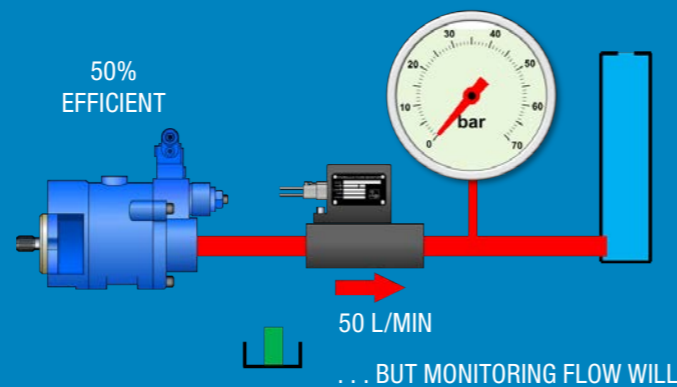
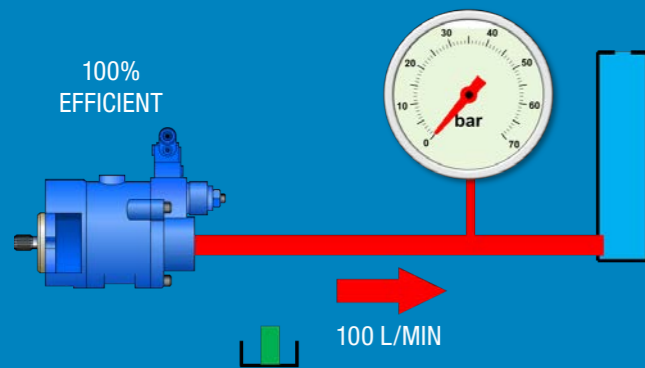

CTA Flowmeter

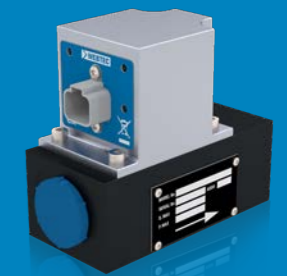

PREDICTIVE MAINTENANCE OF MOBILE MACHINERY USING FLOW CONDITION MONITORING

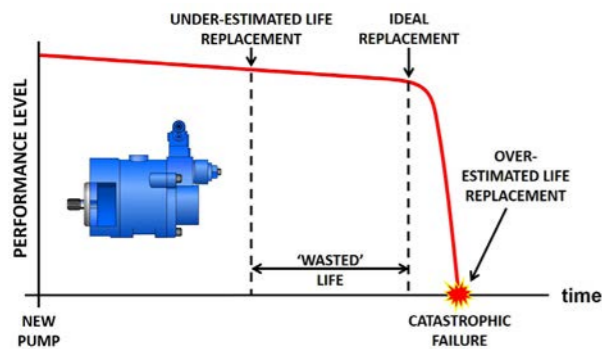

PERIODIC MONITORING MAY NOT BE ENOUGH

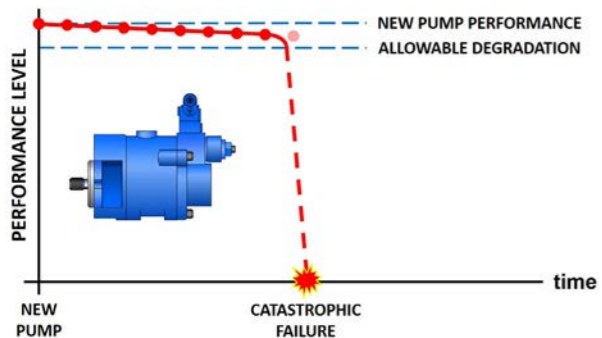

On anything but the simplest of machines, a reactive (or breakdown) maintenance approach is not practical from a cost and disruption point of view. Preventive maintenance is a better approach where the useful life of a component is estimated based on experience, manufacturer's data or testing so that arrangements can be made to replace the component before a catastrophic failure occurs. Where component lifetime data is well documented and operating conditions are predictable then preventive maintenance is a useful and practical procedure. However, if component lifetimes are underestimated then perfectly serviceable components with many hours or even years of useful life remaining may be replaced needlessly. If component lifetimes are overestimated however, catastrophic failures may still occur before the scheduled replacement time is reached.

Taking the example of a pump, which is often the component most likely to wear in a hydraulic system, an unexpected pump failure will usually bring the system and the machine it is operating to a standstill. If the pump has failed catastrophically then considerable time and effort may be involved in locating and fitting a replacement, flushing and recommissioning the system etc. So it would obviously be beneficial if a pump's performance

level could be determined, by measuring its outlet flow for example. But measuring outlet flow at a single point in time may not provide information that is very useful. It doesn't provide any information about the pump's performance history nor does it enable its remaining life to be estimated with any degree of certainty. But if we had information on the performance of the pump when new, and the acceptable level of degradation before the pump needed to be replaced, then a single measurement would be a little more useful. It may then be possible to estimate when the pump might reach the end of its useful life.

In some cases however, wear or degradation of a component does not occur in a gradual or linear manner, but rather it may accelerate unpredictably, caused perhaps by a sudden change in operating conditions. In such cases the predicted component lifetime would no longer be valid and a catastrophic breakdown may still occur. A better solution is therefore to monitor the component's performance at regular, scheduled intervals. This will then provide a history of the pump performance over a period of time and enable a more realistic assessment of the pump's expected life.

But even this approach depends upon whether the monitoring has been carried out consistently and diligently at the specified time intervals and also that the intervals are sufficiently short such that a catastrophic failure does not occur in between two monitoring points.

So an even better procedure would be to monitor the pump's performance continuously, so that any sudden deterioration in performance could be detected immediately and the appropriate action taken. Monitoring pressure in a hydraulic system is a relatively simple process as it only requires a very small connection from the system to the pressure monitoring device. However, many performance losses which can occur in a system may not be evident simply by measuring pressure alone. For example, a deterioration in pump flow caused by wear or damage, seal leakages, improperly seated valves etc. will inevitably result in reduced machine performance but may not create any change in pressure. A pump which is only delivering half of its expected flow would still be able to move a load and so generate normal load pressure, but only at a much reduced speed. A flow monitor permanently installed in the system however could provide enough information to diagnose the problem as a lack of pump flow rather than a leakage inside the actuator.

PREDICT HYDRAULIC PROBLEMS BEFORE THEY HAPPEN



PERMANENTLY INSTALLED ON THE MACHINE



TRANSMIT DATA TO THE CLOUD

VIEW CURRENT & PREDICTED SYSTEM PERFORMANCE

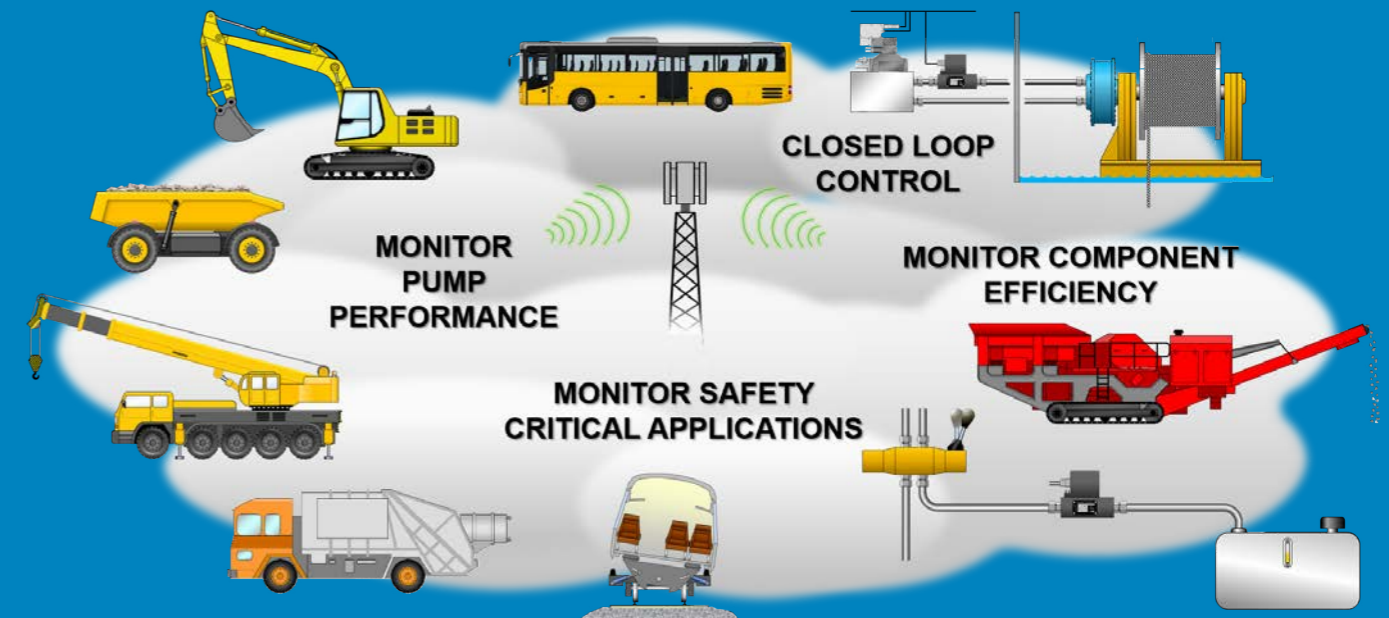

So the performance level of pumps and actuators can most easily be determined by monitoring their output or input flow using a simple, robust flow monitor permanently installed in the system. Such a unit is the Webtec CTA series turbine type flow monitor which provides both a temperature and a flow rate output signal compatible with SAE J1939 CANbus communication as used on many vehicles.

The principle of operation is a well proven design which uses a turbine wheel mounted in the flow stream and a sensor which senses the passing of each turbine blade. In this case, temperature sensing is also carried out by the same sensor. As flow passes through the flow monitor, the turbine blade spins around at a speed proportional to the flow rate. The on-board electronics then convert the sensor pulses into a flow rate signal which can be transmitted via an SAE J1939 CANbus signal to the vehicle's main supervisory control system or via a telematic link to a centralised monitoring and diagnostic station. The same sensor is also used to monitor fluid temperature which can form part of the system performance evaluation process. One or more permanently installed flow monitors can thus form an important part of the predictive maintenance process on a vehicle. By communicating directly to the vehicle's control and monitoring network, performance data can be transmitted to the 'cloud' or Internet of Things (IoT) from

where it can be downloaded and analysed in real time and appropriate alarms raised as necessary.

Typical applications for the Webtec CTA series flow monitor include earthmoving, mining and municipal vehicles, cranes and especially autonomous vehicles. In such applications the flow monitor can be used to continuously assess the pump performance. Where variable displacement pumps are used, regular test routines can be incorporated into the vehicle's operation so that monitoring is carried out under consistent and known operating conditions. Safety critical applications, such as tilting trains or hoists are also ideal situations where continuous flow monitoring can be beneficial. Monitoring the outlet flow from a winch drive motor for example, will give an immediate indication of a potential over-speed and action taken as appropriate.

The volumetric efficiency of a hydraulic motor can be determined by comparing the motor inlet flow with its rotational speed. On-board speed sensors are common options on many hydraulic motors so by knowing the motor displacement, the inlet flow data from a flow monitor will then provide sufficient information to determine the performance level of the motor.

Where actuators operate in hostile environments, possibly subject to rain or salt water, electrical discharges or lightning strikes, extreme temperatures etc, monitoring and transmitting the actuator speed by electrical sensors and cabling may prove problematic.

A feedback signal proportional to the actuator speed can however be obtained by monitoring the actuator flow rate which can then be used for the closed loop speed control of the actuator. The flow monitor, cabling and relevant control valve can then be mounted in a protected area if necessary.

The rugged and compact design of the Webtec CTA Series Flow Monitor make it ideal for on and off-highway vehicles. The units have been designed to be fully EMC compliant, resistant to water spray and steam cleaning, and unaffected by heavy vibration. When used as part of a vehicle's control or predictive maintenance system they can achieve the next level of productivity improvements.

CTA Flowmeter

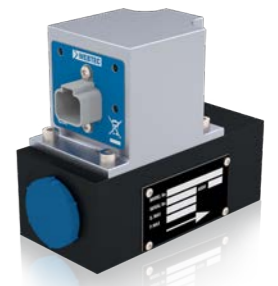

APPLICATION CASE STUDY

PREDICTIVE MAINTENANCE OF MOBILE MACHINERY USING FLOW CONDITION MONITORING

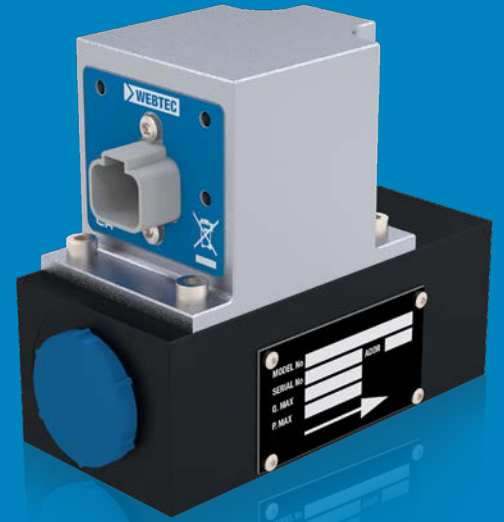

Make it **BLUE**

