

# SAE J1939 CAN compatible sensors for hydraulic system monitoring of flow, pressure and temperature on pumps, valves and hydrostatic transmissions

Up to

- 1500 lpm, 400 US gpm flow measurement
- 1000 bar, 14500 psi pressure measurement

Wide range of cables and accessories available

The CT turbine flow meter range with J1939 compatible output provides a convenient solution to measure flow and temperature in hydraulic systems. The flow meter can be installed anywhere in the hydraulic circuit for production testing, commissioning, development testing and analysis of control systems. With the addition of the manual loading valve on the CTR meters further test scenarios can be simulated and monitored such as pump efficiency.

Pressure sensors with J1939 capability are also available to complement the CT Flow meters. With a pressure sensor all the fundamental parameters of a hydraulic system can be monitored in a single, compact unit with one cable supporting the J1939 protocol.

## Features

### Flowmeters

- **FLOW:** 1-1500 lpm  
0.25 - 400 US gpm
- **PRESSURE:** Up to 480 bar,  
7000 psi
- **PORTING:** BSPP or SAE  
Bi-directional operation
- **Built-in** loading valve optional
- **OUTPUT:** SAE J1939 CAN  
compatible (configured to  
customer's specification)
- **FLUIDS:** Wide range of  
hydraulic oil, lubrication oils,  
and fuels
- **CALIBRATION:** 21 cSt as  
standard. Special calibration  
possible
- **CONSULT SALES** for our  
hydraulic sensors with CAN  
OPEN, 5V and mA outputs

### Pressure Transducers

- **PRESSURE  
TRANSDUCERS**  
**Pressure:** 0 to 1000 bar (0 -  
14500 psi)
- **OUTPUT:** SAE J1939



## Specifications

Model Number	Main ports	Top ports*	Flow range	Max. pressure	PGN	Temp. Range
CT15-J19-B-B-6	1/2" BSPP	1/4" BSPP	1 - 15 lpm	420 bar	65295 (0xFF0F)	0 - 120°C
CT15-J19-S-S-6	3/4" -16UN #8 SAE ORB	7/16" -20UN #4 SAE ORB	0.25 - 4 US gpm	6000 psi	65295 (0xFF0F)	32 - 248°F
CT60-J19-B-B-6	3/4" BSPP	1/4" BSPP	3 - 60 lpm	420 bar	65297 (0xFF11)	0 - 120°C
CT60-J19-S-S-6	1-1/16" -12UN #12 SAE ORB	7/16" -20UN #4 SAE ORB	0.8 - 16 US gpm	6000 psi	65297 (0xFF11)	32 - 248°F
CT150-J19-B-B-6	3/4" BSPP	1/4" BSPP	5 - 150 lpm	420 bar	65298 (0xFF12)	0 - 120°C
CT150-J19-S-S-6	1-1/16" -12UN #12 SAE ORB	7/16" -20UN #4 SAE ORB	1.3 - 40 US gpm	6000 psi	65298 (0xFF12)	32 - 248°F
CT300-J19-B-B-6	1" BSPP	1/4" BSPP	8 - 300 lpm	420 bar	65299 (0xFF13)	0 - 120°C
CT300-J19-S-S-6	1-5/16" -12UN #16 SAE ORB	7/16" -20UN #4 SAE ORB	2 - 80 US gpm	6000 psi	65299 (0xFF13)	32 - 248°F
CT400-J19-B-B-6	1" BSPP	1/4" BSPP	10 - 400 lpm	420 bar	65300 (0xFF14)	0 - 120°C
CT400-J19-S-S-6	1-5/16" -12UN #16 SAE ORB	7/16" -20UN #4 SAE ORB	2.5 - 100 US gpm	6000 psi	65300 (0xFF14)	32 - 248°F
CT600-J19-B-B-5	1-1/4" BSPP	1/4" BSPP	15 - 600 lpm	350 bar	65301 (0xFF15)	0 - 120°C
CT600-J19-F-S-3	1-1/2" #24 SAE Code 61 4-bolt flange	7/16" -20UN #4 SAE ORB	5 - 160 US gpm	3000 psi	65301 (0xFF15)	32 - 248°F
CT600-J19-S-S-5	1-5/8" -12UN #20 SAE ORB	7/16" -20UN #4 SAE ORB	4 - 160 US gpm	5000 psi	65301 (0xFF15)	32 - 248°F
CT800-J19-S-B-7	1-7/8" -12UN #24 SAE ORB	1/4" BSPP	20 - 800 lpm	480 bar	65303 (0xFF17)	0 - 120°C
CT800-J19-S-S-7	1-7/8" -12UN #24 SAE ORB	7/16" -20UN #4 SAE ORB	5 - 210 US gpm	7000 psi	65303 (0xFF17)	32 - 248°F
CT800-J19-F-B-3	1-1/2" #24 SAE Code 61 4-bolt flange	1/4" BSPP	20 - 800 lpm	210 bar	65303 (0xFF17)	0 - 120°C
CT800-J19-F-S-3	1-1/2" #24 SAE Code 61 4-bolt flange	7/16" -20UN #4 SAE ORB	5 - 210 US gpm	3000 psi	65303 (0xFF17)	32 - 248°F
CT800-J19-F-B-6	1-1/2" #24 SAE Code 62 4-bolt flange	1/4" BSPP	20 - 800 lpm	420 bar	65303 (0xFF17)	0 - 120°C
CT1500-J19-F-S-6	2" #32 SAE Code 62 4-bolt flange	7/16" -20UN #4 SAE ORB	12.5 - 400 US gpm	6000 psi	65304 (0xFF18)	32 - 248°F
CT1500-J19-F-S-6-L	2" #32 SAE Code 62 4-bolt flange	7/16" -20UN #4 SAE ORB	50 - 1500 lpm	420 bar	65304 (0xFF18)	0 - 120°C

\*CT 15 has one of the specified top ports.

Model Number	Main ports	Top ports	Flow range	Max. pressure	PGN	Temp. Range
CT300R-J19-B-B-6	1" BSPP	1/4" BSPP	8 - 300 lpm	420 bar	65299 (0xFF13)	0 - 120°C
CT300R-J19-S-S-6	1-5/16" -12UN #16 SAE ORB	7/16" -20UN #4 SAE ORB	2 - 80 US gpm	6000 psi	65299 (0xFF13)	32 - 248°F
CT400R-J19-B-B-6	1" BSPP	1/4" BSPP	10 - 400 lpm	420 bar	65300 (0xFF14)	0 - 120°C
CT400R-J19-S-S-6	1-5/16" -12UN #16 SAE ORB	7/16" -20UN #4 SAE ORB	2.5 - 100 US gpm	6000 psi	65300 (0xFF14)	32 - 248°F
CT600R-J19-F-B-3	1-1/2" #24 SAE Code 61 4-bolt flange	1/4" BSPP	20 - 600 lpm	210 bar	65302 (0xFF16)	0 - 120°C
CT600R-J19-F-S-3	1-1/2" #24 SAE Code 61 4-bolt flange	7/16" -20UN #4 SAE ORB	5 - 160 US gpm	3000 psi	65302 (0xFF16)	32 - 248°F
CT600R-J19-S-B-7	1-7/8" -12UN #24 SAE ORB	1/4" BSPP	20 - 600 lpm	480 bar	65302 (0xFF16)	0 - 120°C
CT600R-J19-S-S-7	1-7/8" -12UN #24 SAE ORB	7/16" -20UN #4 SAE ORB	5 - 160 US gpm	7000 psi	65302 (0xFF16)	32 - 248°F
CT800R-J19-F-B-3	1-1/2" #24 SAE Code 61 4-bolt flange	1/4" BSPP	20 - 800 lpm	210 bar	65303 (0xFF17)	0 - 120°C
CT800R-J19-S-B-7	1-7/8" -12UN #24 SAE ORB	1/4" BSPP	20 - 800 lpm	480 bar	65303 (0xFF17)	0 - 120°C
CT800R-J19-F-S-3	1-1/2" #24 SAE Code 61 4-bolt flange	7/16" -20UN #4 SAE ORB	5 - 210 US gpm	3000 psi	65303 (0xFF17)	32 - 248°F
CT800R-J19-S-S-7	1-7/8" -12UN #24 SAE ORB	7/16" -20UN #4 SAE ORB	5 - 210 US gpm	7000 psi	65303 (0xFF17)	32 - 248°F

CT600R, 800R has limited pressure control below 86 lpm (23 US gpm).

The maximum controllable pressure in this region is calculated by: max pressure (in bar) = 5 x flow (lpm) +30

**Note: The default J1939 Address for all models is 133 (0x85). Please Contact Sales if a different J1939 Address is required.**

### Functional specification

<b>Ambient temperature:</b>	5 to 40 °C (41 - 104 °F)
<b>Fluid type:</b>	Mineral oil to ISO 11158 category HM (for other fluid types please contact Sales).
<b>Fluid temperature:</b>	5 to 90 °C (41 - 194 °F) continuous use.
<b>Accuracy:</b>	15 to 100% of range - 1% of indicated reading Below 15% fixed accuracy of 1% of 15% of full scale (CT15 is 1% of full scale)
<b>Repeatability:</b>	Better than ± 0.2%
<b>Response Time:</b>	50ms + 1 period (turbine frequency)
<b>Degree of protection*:</b>	IP66 (EN60529) *With cable connected
<b>Bus speed:</b>	250KHz

### Electrical specification

<b>Supply voltage (VS):</b>	8 - 40 VDC
<b>Current:</b>	5mA @32v, 20mA @8v
<b>Output:</b>	SAE J1939 compatible (not fully compliant)

### Calibration

Calibrations are conducted at a mean viscosity of 21cSt using ISO32 hydraulic mineral oil to ISO11158 category HM. Calibration certificates are available on request - this is a chargeable option.

### Construction material

<b>Flow body:</b>	600/800/1500 High tensile Aluminium 2014A T6 15/60/150/300/400 High tensile Aluminium 2011 T6
<b>Internal parts:</b>	Aluminium, Steel, Stainless Steel.
<b>Transducer:</b>	Body and nut -steel 212A42 electroless nickel plated, Housing and Lid - Aluminium 2011 T3
<b>Seals:</b>	FKM seals as standard EPDM are available (For flow meters without loading valve - CT only) - please consult sales office.

## Operation

As fluid passes through the flow meter it rotates a precision turbine. The turbine is mounted with flow straighteners which are designed to minimize the effects of turbulence. The turbine rotation is detected by a magnetic reluctance transducer that signals RPM to the microcontroller. The microcontroller converts the RPM signal in to an equivalent flow and corrects for dynamic variances to achieve 1% of indicated flow rate. Temperature is sensed at the tip of the transducer which is in contact with the oil flow. Flow and temperature values are combined by the microcontroller and transmitted in a standard J1939 frame format.

## Reverse Flow

The flow block is capable of measuring flow in either direction.

## Calibration

All units are calibrated with 21 cSt oil as standard. Calibration certificates are available on request - this is a chargeable option. Production calibration of CT1500 lpm turbine is confirmed by testing over the range of 50 to 750 lpm and by design only above 750 lpm. Other calibration on request - please consult the sales office.

## Installation

The flow block has built-in flow straighteners so the normal recommended length of 10 Ø of straight tube can be reduced to 8 Ø where space is limited. Inlet and outlet connections should always be of a similar bore size to that of the flow block to

prevent venturi or constriction effects. The range of flow meters can be used for intermittent or continuous testing of flow in either direction. The flow block can be mounted in any orientation. For heavy duty applications where the flow block will be used constantly with continuous pressure spikes please contact sales to discuss your application.

## Filtration

It is recommended that a 25-micron (10 micron for CT15) filter is installed in the circuit prior to the flow block.

## Top ports

Most flow meters have two ports for additional sensors in the top face (see tables for specific configuration). A range of J1939 compatible pressure sensors are available to fit these ports.

All meters are supplied with one M16x2 test point fitted as standard.

## Ordering

To order a J1939 CT flow meter consult sales to discuss your application and any custom J1939 Address requirements. Please quote the appropriate model number from the tables, e.g. CT15-J19-B-B-6.

All flow meters can have a pressure sensor fitted to an auxiliary top port. Quote the required model number from the Pressure Sensor Model Table.

## Pressure Drop Chart

Hydraulic Oil Viscosity 21 Centistokes

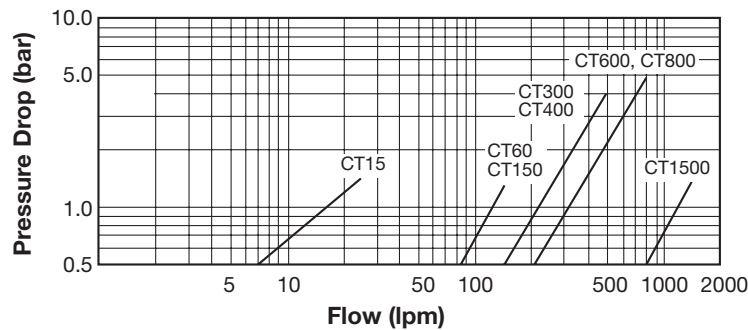

### Note:

1 UK gallon = 4.546 litres  
1 US gallon = 3.785 litres

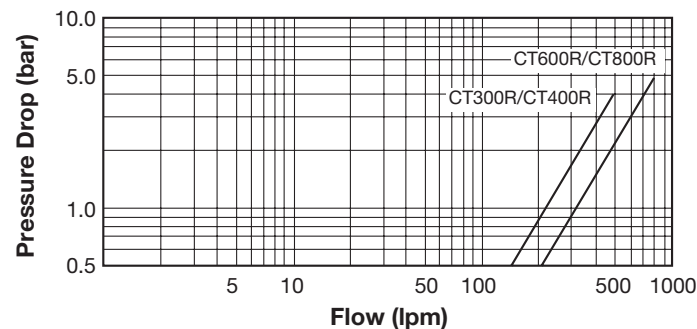

### Note

1 UK gallon = 4.546 litres  
1 US gallon = 3.785 litres

## M12 Connection Details

### Cables, Splitters and Terminators:

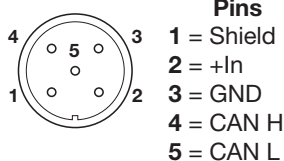

Model Number	Description
SR-CBL-0.5-MF-CAN	0.5m cable
SR-CBL-02-MF-CAN	2m cable
SR-CBL-05-MF-CAN	5m cable
SR-CBL-10-MF-CAN	10m cable
SR-CBL-20-MF-CAN	20m cable
SR-CBL-0.05-Y-CAN	'Y' Splitter - no cable
SR-CBL-0.3-Y-CAN CAN	'Y' splitter, including 0.3 m cable
SR-CBL-000-R-CAN CAN	Terminating resistor – one per bus

### Pressure sensor model table

Model Number	Pressure Range:	Maximum over-pressure:	Pressure Connection	Default J1939 Address
MPT060BBJ	0 - 60 bar	120 bar	1/4" BSPP	100
MPT100BBJ	0 - 100 bar	200 bar	1/4" BSPP	101
MPT160BBJ	0 - 160 bar	320 bar	1/4" BSPP	102
MPT250BBJ	0 - 250 bar	500 bar	1/4" BSPP	103
MPT400BBJ	0 - 400 bar	800 bar	1/4" BSPP	104
MPT600BBJ	0 - 600 bar	1200 bar	1/4" BSPP	105
MPT1K0BBJ	0 - 1000 bar	1500 bar	1/4" BSPP	106
MPT1K0PUJ	1000 psi	1740 psi	7/16"-20un #4 SAE ORB	107
MPT1K5PUJ	1500 psi	2900 psi	7/16"-20un #4 SAE ORB	108
MPT2K0PUJ	2000 psi	4000 psi	7/16"-20un #4 SAE ORB	109
MPT3K0PUJ	3000 psi	6000 psi	7/16"-20un #4 SAE ORB	110
MPT5K0PUJ	5000 psi	10000 psi	7/16"-20un #4 SAE ORB	111
MPT10KPUJ	10000 psi	17400 psi	7/16"-20un #4 SAE ORB	112

Please Contact Sales if a different J1939 Address is required.

### Pressure Sensor Specification:

<b>Accuracy:</b>	≤ ±1% of FSD.	
<b>Power Supply:</b>	10v ... 30v DC.	
<b>Current:</b>	≤ 40mA.	
<b>Measuring rate:</b>	100ms	
<b>Non-Linearity:</b>	≤ ±0.2% of FSD.	
<b>Bus speed:</b>	250KHz	
<b>Temperature drift:</b>	0...60°C:	≤ ±0.5% of FSD.
	-20...85°C:	≤ ±1% of FSD.
<b>Additional temperature drift:</b>	-40...85°C	0.2% per 10°C.
<b>Long term stability:</b>	≤ ±0.2% of FSD per year.	

### Dimensions (mm)

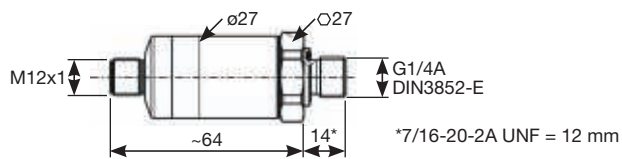

### Dimensions in mm (inches)

Model No	A	B	C	D	E	Weight kg (lbs)
CT15	37 (1-1/2")	136 (5-3/8")	37 (1-1/2")	123 (5")	69.5 (2-3/4")	0.7 (1.5)
CT60	62 (2-1/2")	190 (7-1/2")	50 (2")	136 (5-3/8")	103 (4")	1.6 (3.5)
CT150	62 (2-1/2")	190 (7-1/2")	50 (2")	136 (5-3/8")	103 (4")	1.6 (3.5)
CT300	62 (2-1/2")	190 (7-1/2")	50 (2")	140 (5-1/2")	103 (4")	1.7 (3.7)
CT400	62 (2-1/2")	190 (7-1/2")	50 (2")	140 (5-1/2")	103 (4")	1.7 (3.7)
CT600	62 (2-1/2")	212 (8-3/8")	75 (3")	152 (6")	127 (5")	2.7 (6)
CT600-**-F-**-*	100 (4")	212 (8-3/8")	75 (3")	152 (6")	126 (5")	5.0 (11)
CT800	100 (4")	212 (8-3/8")	75 (3")	152 (6")	126 (5")	5.0 (11)
CT800 (code 62)	113 (4-1/2")	212 (8-3/8")	100 (4")	165 (6 1/2")	126 (5")	6.0(13.2)
CT1500	140 (5-1/2")	260 (10-1/4")	100 (4")	176 (7")*	130 (5-1/8")	10.0 (22)

\* CT1500 includes 4 feet on base, add 20 mm (3/4") to D for full height.  
 CT1500 is fitted with carry handles - not shown on diagram.

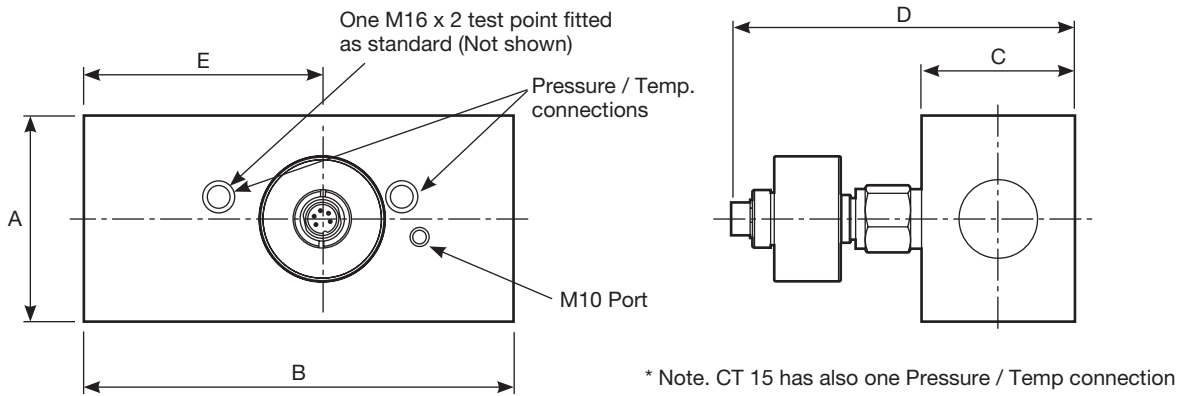

\* Note. CT 15 has also one Pressure / Temp connection

### Dimensions in mm (inches)

Model No	A	B	C	D	E	F	G	Weight kg (lbs)
CT300R	49 (2")	100 (4")	182 (7-1/8")	222 (8-3/4")	102.5 (4")	47.6 (1-7/8")	138 (5-1/2")	3.7 (8.1)
CT400R	49 (2")	100 (4")	182 (7-1/8")	222 (8-3/4")	102.5 (4")	47.6 (1-7/8")	138 (5-1/2")	3.7 (8.1)
CT600R	75 (3")	125 (5")	211 (8-3/8")	235 (9-3/4")	99 (3-7/8")	63 (2-1/2")	157 (6-1/8")	7.5 (16.5)
CT800R	75 (3")	125 (5")	211 (8-3/8")	235 (9-3/4")	99 (3-7/8")	63 (2-1/2")	157 (6-1/8")	7.5 (16.5)

Add 20mm (3/4") to G for full height including feet.

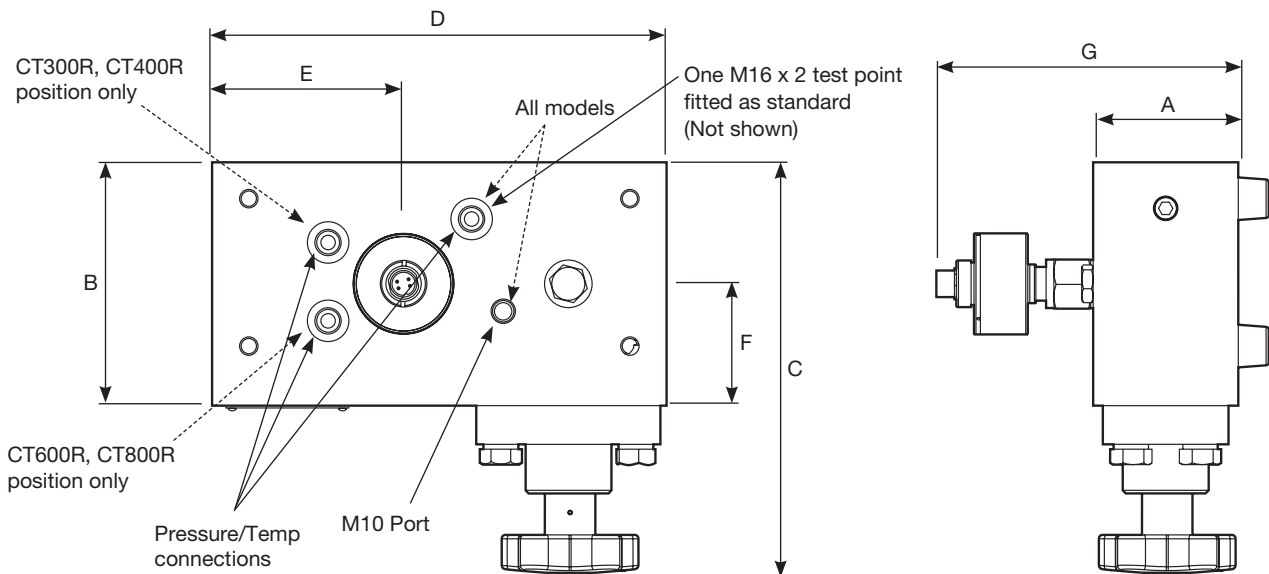

## Turbine Flow Meters

### Accuracy

The accuracy is better described as the uncertainty of the flow reading compared to a known reference. Every flow measurement has an error associated with it, caused by the combination of a large number of factors that affect the operation of the flow meter, these include bearing friction, temperature, viscosity, magnetic drag and the signal strength to name but a few.

All our flow meters are calibrated at 10 points over the flow range and its performance measured against a flow reference that is traceable to International standards. Accuracy is typically quoted in one of two ways: as a percentage of full scale (the maximum calibrated flow) or as a percentage of the indicated reading (the actual flow).

### Full scale (FS) or full scale deflection (FSD)

A term that was originally used for analogue displays where a needle pointed to a number on a scale, hence FSD. The flow accuracy is a fixed amount regardless of the actual flow you are measuring. For example 1% FS for a flow meter with a maximum calibrated flow of 400 lpm is  $\pm 4$  lpm whether you are measuring 40 lpm, 200 lpm or 400 lpm (see graph below). If you need to measure flows of 40 and 400 lpm with same flow meter then it is important to check the allowable error at all flows.

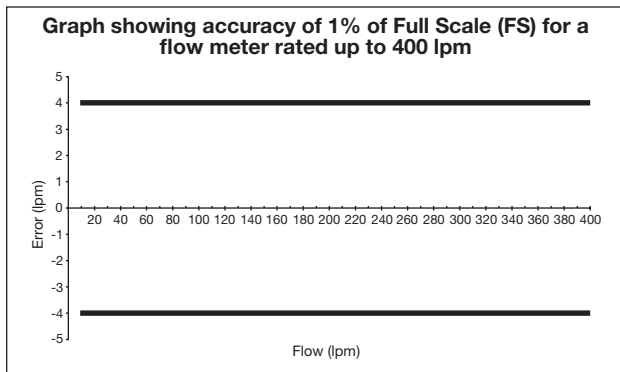

### Indicated reading (IR)

Accuracy is quoted as a percentage of the actual value measured. So if the accuracy of a 400 lpm flow meter is 1% IR then the error at 400 lpm is  $\pm 4$  lpm. As the actual flow measured reduces, so does the error in lpm. When measuring a flow of 60 lpm with an accuracy of 1% IR, the possible error is  $\pm 0.6$  lpm. At very low flows, the possible errors are no longer proportional to the flow rate, but actually a fixed amount in lpm (see graph below). For example if the accuracy is quoted as 1% IR (>60 lpm) for a flow meter with the range 10 - 400 lpm, then the accuracy is 1% of the actual flow in the range 60 to 400 lpm and a fixed flow error in the range 10 to < 60 lpm.

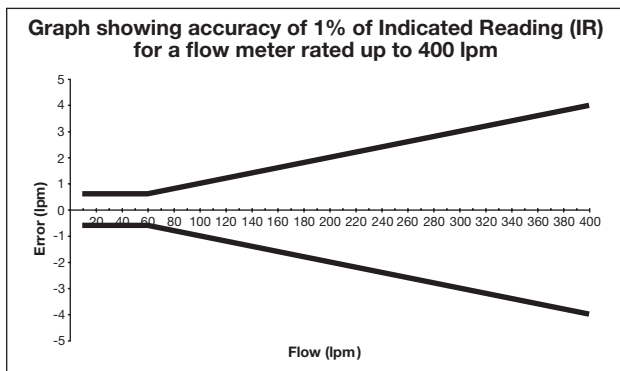

### Repeatability

The repeatability is the variation in the performance of the flow meter when used under the same conditions. Our range of flow meters has excellent repeatability of better than  $\pm 0.2\%$ . This is just as important as the accuracy since in many applications the flow readings from the same flow meter will be compared at regular intervals to look for any change in performance of the system.

### Flow range (Turndown ratio)

A turbine flow meter has a minimum and a maximum calibrated flow which together describe the range of flows that can be accurately measured. Through the addition of signal conditioning either mounted on the flow meter or built into the readout, the flow range of our flow meters has been extended considerably compared to other models on the market; the ratio of the maximum to the minimum calibrated flow (turndown ratio) is between 15 and 40 across all models. Particular effort has been made to extend the flow range by calibrating down to lower flows enabling one flow meter to be used where two may have been required in the past. This makes the flow meter both a more economical and easier to install solution.

### Calibration

All flow meters are calibrated at a mean viscosity of 21 cSt using ISO32 hydraulic mineral oil to ISO11158 category HM. Special calibration is available over a custom flow range or at a different viscosity, please contact sales to discuss your application.

Recommended period between calibrations is 12 months. Maximum period between calibrations is 36 months. Unit accuracy may be affected by operating cycle, fluid condition or extended periods between recalibrations.

### Fluid viscosity

The performance of a turbine flow meter can be affected by the viscosity of the fluid measured. The kinematic viscosity of all hydraulic fluids is related to the fluid temperature and the table below shows the affect of temperature on the kinematic viscosity of a range of typical grades of hydraulic oil.

The shaded area of the table shows the range of viscosities that can be measured by a flow meter with standard calibration with minimal effect on the accuracy (less than  $\pm 1\%$  FS).

Flow meters can be specially calibrated at a different viscosity to the standard or we can advise on the expected error when the flow meter is used at other viscosities, please contact sales for further information.

**Table showing kinematic viscosity (cSt) of different mineral oils at specific temperatures**

Temp °C	Fluid type					
	ISO15	ISO22	ISO32	ISO37	ISO46	ISO68
0	85.9	165.6	309.3	449.9	527.6	894.3
10	49.0	87.0	150.8	204.7	244.9	393.3
20	30.4	50.5	82.2	105.5	127.9	196.1
30	20.1	31.6	48.8	59.8	73.1	107.7
40	14.0	21.0	31.0	36.6	44.9	63.9
50	10.2	14.7	20.8	23.9	29.4	40.5
60	7.7	10.7	14.7	16.5	20.2	27.2
70	6.0	8.1	10.9	12.0	14.6	19.2
80	4.8	6.4	8.4	9.1	11.1	14.3
90	4.0	5.2	6.6	7.2	8.7	11.1
100	3.3	4.3	5.5	6.0	7.1	8.9

ISO 15, 22, 32, 46 and 68 based on typical figures for the Esso Nuto range of HM oils. ISO 37 based on Shell Tellus HM oil.



APPROVED

Webtec reserve the right to make improvements and changes to the specification without notice