

Product overview



Table of contents

	Page		Page
About us	4	03 Känguruh systems®	78
Your partner for sterile supplies logistics	6	04 Shelving systems	86
01 Baskets and containers	8	The Norm shelving system	88
Sterile goods baskets	10	Norm 5 shelving unit	90
Sterile goods basket accessories	18	Norm 5 Medidul shelving unit	102
Mesh trays and mesh baskets	20	Norm 25 shelving unit	108
Accessories for mesh trays and mesh baskets	24	Norm 20 shelving unit	112
Fine mesh baskets	28	Norm 12 shelving unit	124
Special baskets	30	Easy Rider systems	128
Containers	34	Mobile shelving	130
		Wall shelving	134
02 Transport solutions	38	05 Medical furnishings	138
Container and sterile goods transport carts	40	MediFurn	140
Hook trolleys	46	Medical furnishings	148
Accessories for hook trolleys	52	06 Laundry and waste collectors	164
Attachments	54	Laundry and waste collectors	166
Transport trolleys	62	Theatre laundry/waste collectors	168
Accessories for service trolleys	70		
OP equipment trolleys	72		

Our most successful product is customer satisfaction



Outstanding quality down to the finest detail

Quality is our unmistakable trademark, from material and workmanship right through to functionality, safety, service and punctual delivery. We ensure this with our state-of-the-art planning and manufacturing technology, with carefully chosen suppliers and partners, as well as comprehensive quality assurance.

But besides all the technology, it is above all our excellently trained employees who characterise the Hupfer brand. From development to delivery, they accompany every product with their expertise and perfect craftsmanship right down to the last detail.



Tested safety right from the start

Hupfer is certified as a developer and manufacturer of medical products in accordance with DIN EN ISO 13485. This means you can be sure that our solutions offer the highest standards of quality and reliability – from the technology right through to the service.

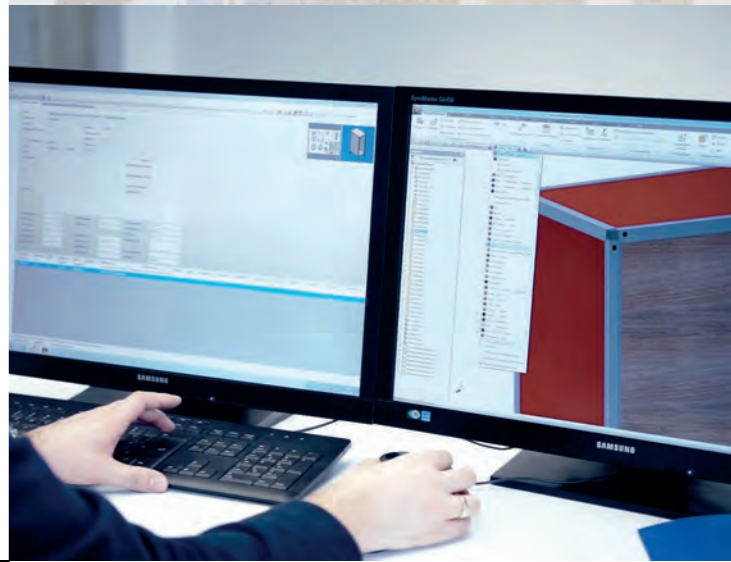

Our success story began with metalworking and wire mesh processing, and we have added many exciting new chapters to it over the years. Our philosophy and actions have always been determined by our understanding of quality, our instinctive grasp of precision and our aspiration to always offer the best possible solutions.

We have continually grown along with the challenges and expectations of our customers. Today Hupfer is a specialist for kitchen and sterile supplies logistics, offering bespoke "Made in Germany" concepts appreciated by more and more customers around the world.

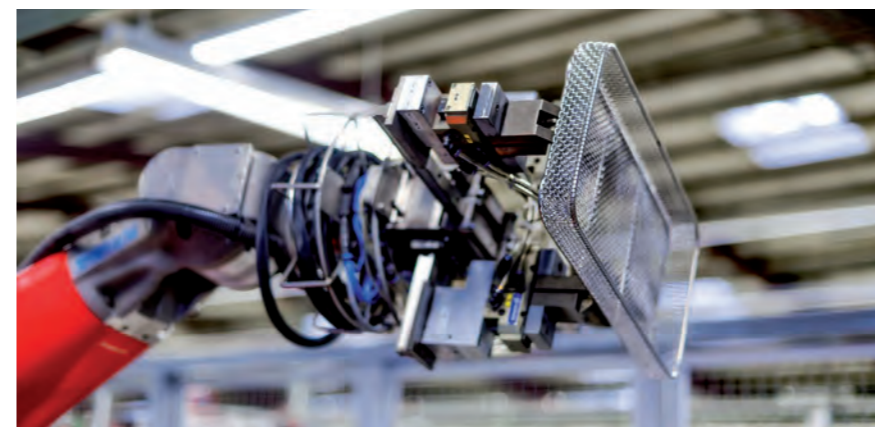

Your partner for innovative sterile supplies logistics



At Hupfer we develop our products and systems based on a deep understanding of the logistical structures and individual requirements of clinics and medical departments.

As specialists for sterile supplies logistics, we offer integrated solutions for supplying and disposing of sterile goods. Whether sorting, packaging, organising, transporting, storing or distributing – Hupfer helps you optimise work processes, increase occupational safety and guarantee the highest standards of hygiene for cleaning, disinfecting and sterilising.

With decades of experience, in-depth knowledge of the industry and convincing ideas, we support planners, specialist dealers and users, so that everyone involved can be sure that they can ultimately achieve the goals we all share: safety, cost-effectiveness and genuinely satisfied customers, including the patients.

Anytime, anywhere:
the highest standards of safety and hygiene

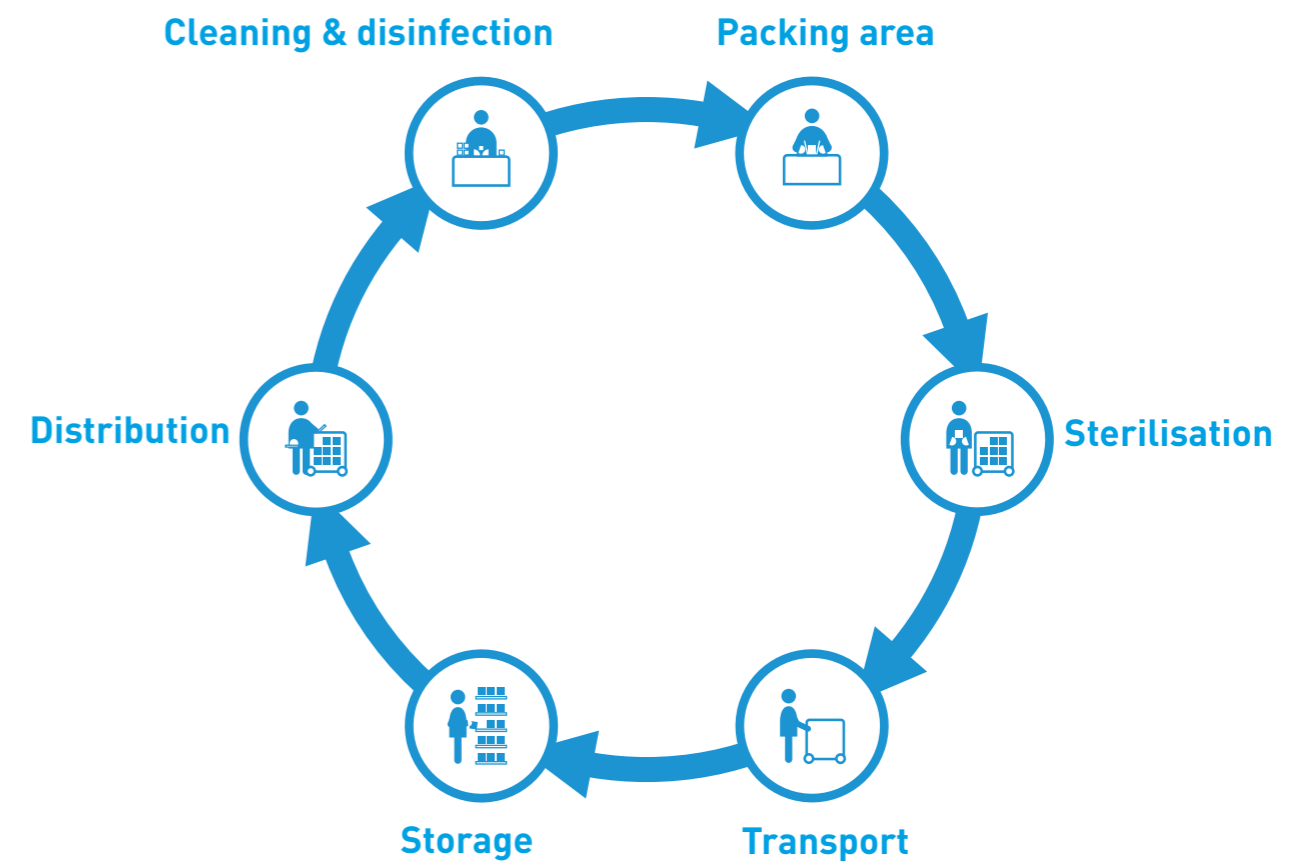

Baskets and containers

Careful and structured handling of sterile supplies is the basis for many crucial processes in clinics, hospitals and sterilisation facilities. Hupfer offers a comprehensive range of baskets and containers for a wide variety of applications and requirements. They meet the highest quality standards from the material to the workmanship and guarantee optimum functionality and safety in daily use.



Sterile goods baskets



Excellent products with decisive advantages

Wire sterile goods baskets are used for transporting and storing sterile supplies in soft packaging. Some designs can be used in cabinet systems as well as in shelving systems or in connection with wall-mounted hook rails. They are also used in open and enclosed transport trolleys.

Hupfer sterile goods baskets are made of high-quality, electropolished stainless steel, are designed for rugged daily use, and are manufactured with care and precision for safe handling, durability and easy cleaning.

Whether stackable on top of or inside each other or for hanging on wall-mounted hook rails – our comprehensive range of sterile goods baskets has the right solution for every requirement and area of use.

- Completely hygienic, protected transport
- Space-saving storage
- Practical provision
- Edge protection for safer handling

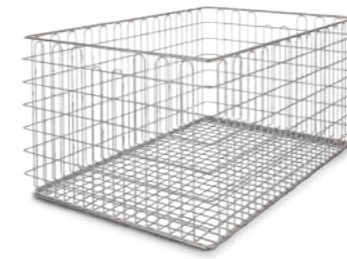

Sterile goods baskets



Insertable SPRI sterile goods basket

- With pull-out frame
- Stackable inside and on top of each other
- With fold-down handles

	SPRI	Dimensions W x D x H (mm)	Product code
SteriKo Spri-1/2 585/395/100 KG	1/2	585 x 395 x 100	7593507
SteriKo Spri-1/1 585/395/195 KG	1/1	585 x 395 x 195	7593508

Sterile goods baskets – stackable inside each other

These sterile goods baskets are designed to ensure a rapid workflow while requiring little space. They can be stacked inside each other to save space at the packing table, and then stacked on top of each other once filled. The sophisticated, carefully manufactured wire mesh structure is ideal for safe handling, stability, optimum cleaning and hygiene. Large quantities of empty baskets can be neatly stacked deep into each other, then cleaned and disinfected in a single process.



Insertable StU sterile goods basket

- With pull-out frame
- Stackable inside and on top of each other
- With fold-down handles

	StU	Clear internal floor dimension (mm)	Dimensions W x D x H (mm)	Product code
SteriKo StE-1/1 600/300/260 KG SchR	1/1	541 x 261	600 x 300 x 260	7500011
SteriKo StE-1/2 600/300/138 KG SchR	1/2	541 x 261	600 x 300 x 138	7500012
SteriKo StE-1/3 600/300/97 KG SchR	1/3	541 x 261	600 x 300 x 97	7500013



Insertable ISO sterile goods basket

- With pull-out frame
- Stackable inside and on top of each other

	ISO	Dimensions W x D x H (mm)	Product code
SteriKo ISO-1/3 600/400/100 SchR	1/3	600 x 400 x 100	7214005
SteriKo ISO-1/2 600/400/130 SchR	1/2	600 x 400 x 130	7214015
SteriKo ISO-1/2 600/400/150 SchR	1/2	600 x 400 x 150	7214016
SteriKo ISO-2/3 600/400/180 SchR	2/3	600 x 400 x 180	7214006



Sterile goods baskets

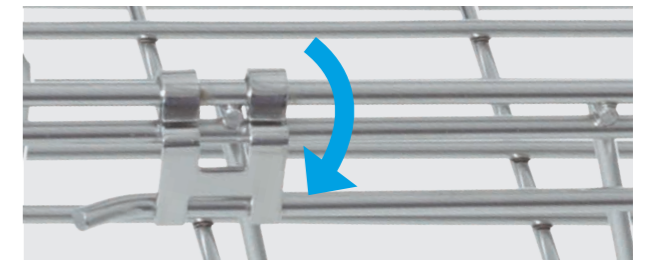
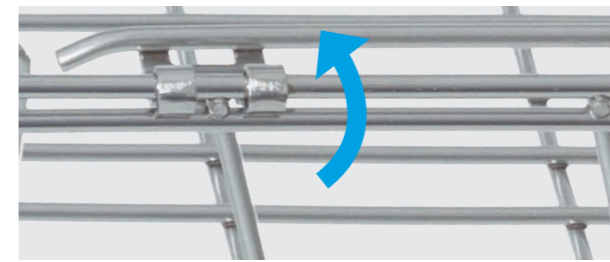
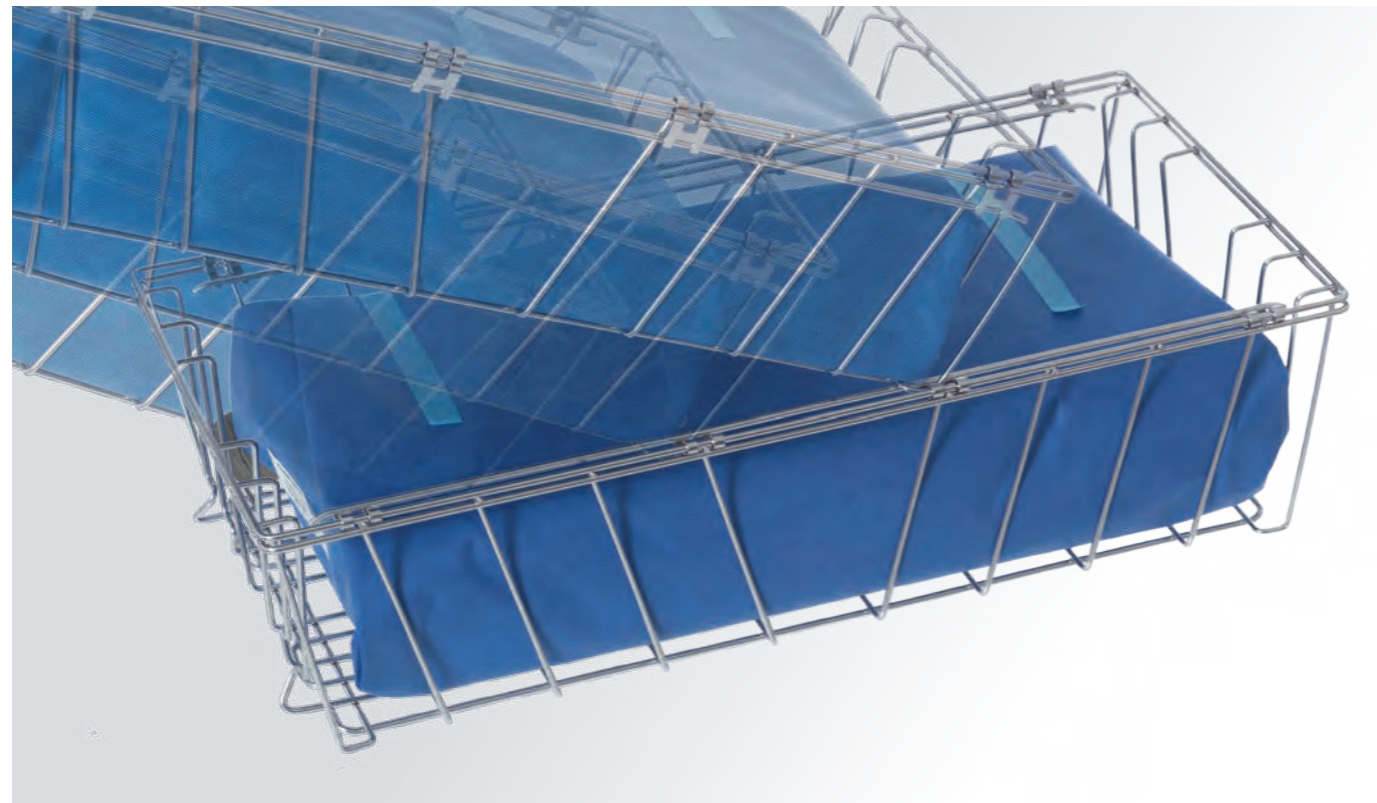

Slide rails folded down: Baskets can be stacked on top of each other and individually slid in and out.

Slide rail folded out: Baskets can be stacked inside each other to save space.

ErgoSlide® Sterile goods basket – stackable with innovative slide rail

The Hupfer ErgoSlide® series offers extra safety and ergonomics in sterile supplies logistics. Thanks to the side rails, the baskets can be slid over each other and removed again without the upper basket slipping into the one below. For stacking, the slide rails are simply folded outwards or inwards. The robust hinges can be easily checked for dirt and cleaned if necessary.



StU sterile goods basket – not insertable into U-shaped rails

- Stackable inside and on top of each other
- With folding handles on sides with slide rail function

	StU	Clear internal floor dimension (mm)	Dimensions W x D x H (mm)	Product code
	SteriKo StE-1/1 600/292/260 KG	547 x 268	600 x 292 x 260	7501862
	SteriKo StE-1/2 600/292/138 KG	547 x 268	600 x 292 x 138	7501860
	SteriKo StE-1/2 600/292/150 KG	547 x 268	600 x 292 x 150	7501861
	SteriKo StE-1/3 600/292/97 KG	547 x 268	600 x 292 x 97	7501863



Sterile goods baskets



Sterile goods baskets – stackable on top of each other

Stacked on top of each other, these baskets allow clearly arranged provision of working material and sterile supplies. Versions with straight access openings, inclined access openings and access and handle openings allow instant access to baskets and the items in them. Baskets filled with sterile supplies can be stacked on top of each other without any problems. They are also suitable for hanging on wall-mounted hook rails, hook racks and hook trolleys.



Sterile goods basket with access opening from above ...



... with inclined access opening ...



... with broadside access opening.



Perfectly arranged: sterile supplies always at hand



Stackable StU sterile goods basket

- Stackable on top of each other
- With handle opening

Design	StU	Dimensions W x D x H (mm)	Product code
SteriKo StE-1/2 575/280/135 GrÖ	1/2	575 x 280 x 135	7500016
SteriKo StE-1/2 575/280/135 GrÖ ES	1/2	575 x 280 x 135	7500148
SteriKo StE-1/1 575/280/265 GrÖ	1/1	575 x 280 x 265	7500017
SteriKo StE-1/1 575/280/265 GrÖ EÖ	1/1	575 x 280 x 265	7500018
SteriKo StE-2/1 575/560/265 GrÖ	2/1	575 x 560 x 265	7500019



Stackable StU sterile goods basket

- Stackable on top of each other
- With handle opening

Design	StU	Dimensions W x D x H (mm)	Product code
SteriKo StE-1/1 600/300/300 GrÖ	1/1	600 x 300 x 300	7500020
SteriKo StE-1/2 600/300/150 GrÖ	1/2	600 x 300 x 150	7500021
SteriKo StE-1/2 600/300/150 GrÖ ES	1/2	600 x 300 x 150	7500301
SteriKo StE-1/1 600/300/300 GrÖ EÖ	1/1	600 x 300 x 300	7500022

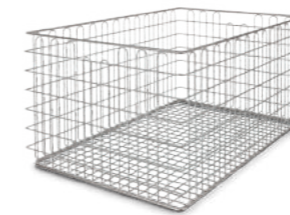

Stackable ISO sterile goods basket

- Stackable on top of each other
- With handle opening

Design	ISO	Dimensions W x D x H (mm)	Product code
SteriKo ISO-1/1 600/400/300 GrÖ	1/1	600 x 400 x 300	7500626
SteriKo ISO-1/1 600/400/300 GrÖ EÖ	1/1	600 x 400 x 300	7500969
SteriKo ISO-1/2 600/400/150 GrÖ	1/2	600 x 400 x 150	7500625

Sterile goods basket for 1/6 StU

This special basket is designed for holding and storing instruments and large trays. It is suitable for Norm 5 Medidul shelving systems, cabinet systems with L rails and use in the Hupfer Känguruh System®.



Stackable StU sterile goods basket

- With pull-out frame
- Edge protection for safety

Design	StU	Dimensions W x D x H (mm)	Product code
SteriKo StE-1/6 600/300/44 GrÖ	1/6	600 x 300 x 44	7501508

Sterile goods basket accessories



With useful and practical accessories, the functionality and handling of sterile goods baskets can be individually extended according to how and where they are used. From basket dividers to damage protection clips, our range of accessories provide first-class solutions for every requirement.



Basket divider

■ Wire thickness: Ø 2.5 mm

	For article/model	Dimensions W x H (mm)	Product code
Basket divider 278/118/5	Basket 7500016	278 x 118	7500218
Basket divider 298/126/5	Basket 7500021	298 x 126	7500220
Basket divider 278/241/8	Basket 7500017	278 x 241	7500219
Basket divider 298/271/8	Basket 7500020	298 x 271	7500221
Basket divider 262/126/9	Basket 7500148	262 x 126	7500149



Wire basket divider

■ Wire thickness: Ø 2.5 mm

	For article/model	Dimensions W x H (mm)	Product code
Wire basket divider 282/141/8	7500516: Basket 7500301	282 x 141	7500516
Wire basket divider 398/121/8	7500517: Basket 7500625	398 x 121	7500517



Wire basket divider

■ Wire thickness: Ø 2.5 mm

	For article/model	StU	Dimensions W x H (mm)	Product code
Wire basket divider 600/150	Basket 7500021	1/2	598 x 126	7502949
Wire basket divider 600/300	Basket 7500020 + 7500022	1/1	598 x 271	7502950



Damage protection clip for the sterile goods basket

- Suitable for baskets with 3.5 mm wire thickness
- Especially for ErgoSlide® and insertable StU sterile goods baskets.

	Dimensions W x H (mm)	Product code
Damage protection clip for sterile goods basket	101 x 25	7500279

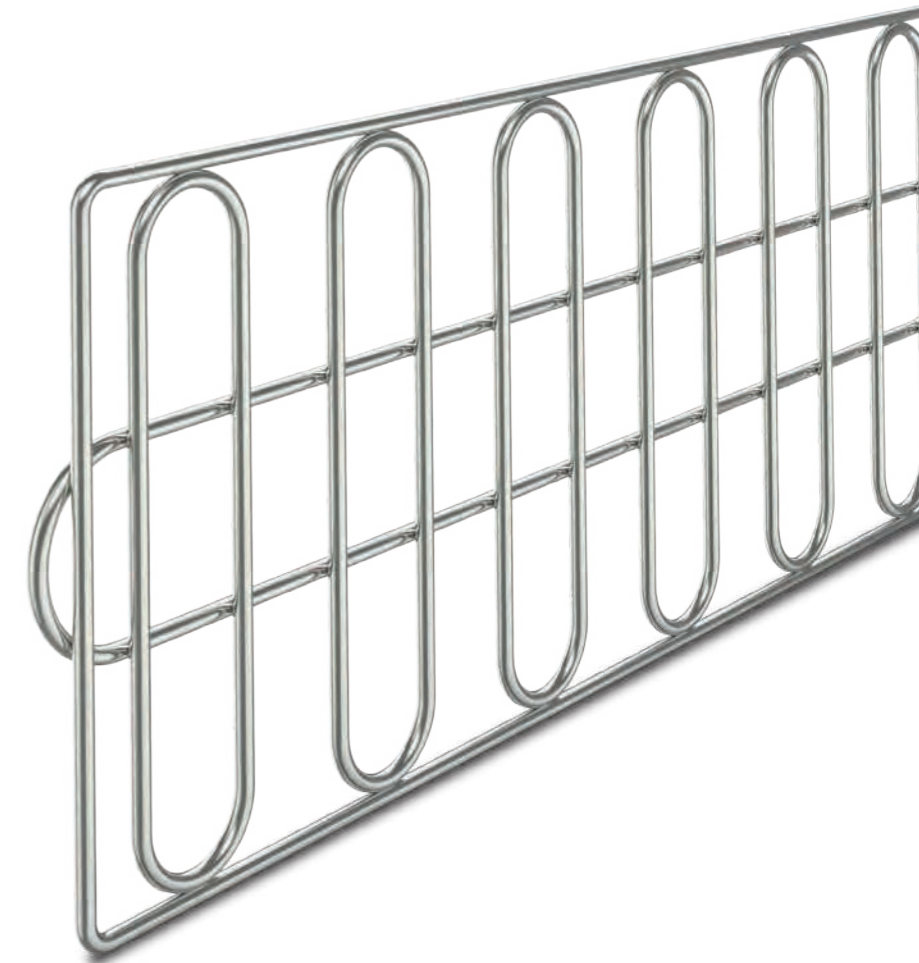

Mesh trays and mesh baskets



Hupfer mesh trays

Hupfer mesh trays and mesh baskets are manufactured to the highest quality standard and meet the strict safety requirements for everyday clinical practice. Because they are carefully manufactured without sharp edges and corners, they not only provide optimum protection for instruments and soft packaging, but also safety for staff and patients during handling. The sturdy design guarantees high loading capacity and outstanding durability.



Quality without sharp corners and edges. The careful manufacturing of Hupfer mesh trays and mesh baskets increases safety during daily work – to protect employees and sensitive materials.



Hupfer mesh trays

- Burr-free top frame without sharp edges and corners
- Smooth wire mesh protects the stored material
- Mesh size designed for optimum cleaning and drying
- Floor struts for high loading capacity
- Sturdy corner struts to protect from damage

Hupfer mesh baskets

- Each individual wire is welded so that the mesh floor is completely connected
- Upper frame is welded to the perforated plate
- The finely perforated, burr-free perforated plate protects fine and sharp-pointed instruments from pushing through the mesh
- Holes in the sides and floor are optimally sized for cleaning and drying
- Floor struts for high loading capacity

Hupfer mesh baskets (dry mesh)

- Version without base frame to reduce condensation water
- Broad weight distribution for optimum protection of soft packaging
- Upper frame welded to perforated plate
- The finely perforated, burr-free perforated plate protects fine and sharp-pointed instruments from pushing through the mesh
- Ideally suited for the use of soft packaging as a sterile barrier system



Mesh trays and mesh baskets



Mesh trays

Hupfer mesh trays are made of high-quality electropolished round stainless steel wire and are hygienic and easy to clean. The special shape of the base frame means the mesh trays can be safely and neatly stacked on top of each other. The internal drop handles on the short sides make them particularly easy to handle.



Mesh tray with drop handles

- Mesh size: 4.64 x 4.64 mm
- With stackable frame

	Dimensions W x D x H (mm)	Product code
SiSch 240/250/50 SR FG DM	240 x 250 x 50	7500053
SiSch 240/250/70 SR FG DM	240 x 250 x 70	7500046
SiSch 240/254/50 SR FG DM	240 x 254 x 50	7500001



Mesh tray with drop handles

- Mesh size: 4.64 x 4.64 mm
- With stackable frame

	Dimensions W x D x H (mm)	Product code
SiSch 480/250/50 SR FG DM	480 x 250 x 50	7500059
SiSch 480/250/70 SR FG DM	480 x 250 x 70	7500048
SiSch 480/250/100 SR FG DM	480 x 250 x 100	7500049
SiSch 480/254/50 SR FG DM	480 x 254 x 50	7500004
SiSch 510/254/50 SR FG DM	510 x 254 x 50	7500065
SiSch 540/252/60 SR FG DM	540 x 252 x 60	7500070



Double bin basket

- With stackable frame
- With locking mechanism
- Mesh size: 4.64 x 4.64 mm

	Dimensions W x D x H (mm)	Product code
SiSch/VER 265/250/100 SR VG DM	265 x 250 x 100	7501187
SiSch/VER 505/250/100 SR VG DM	505 x 250 x 100	7501188

Mesh baskets with perforated sides

With high-quality perforated sides, Hupfer mesh baskets offer particular protection from damage. This means they are suitable for very fine, pointed and conically tapered instruments as well as for sensitive soft packaging. The bottoms, made of welded mesh, allow for optimum drainage and ensure no areas are missed when cleaning and disinfecting.



Mesh basket with drop handles

- With stackable frame
- Mesh size: 6 x 6 mm
- Perforated plate thickness: 0.8 mm

	Dimensions W x D x H (mm)	Product code
SiKo 240/250/66 SR FG LB/SG	240/250/66	7501295
SiKo 480/250/66 SR FG LB/SG	480/250/66	7501296
SiKo 510/250/66 SR FG LB/SG	510/250/66	7501297



Mesh basket with drop handles and dry mesh

- Mesh size: 6 x 6 mm
- Perforated plate thickness: 0.8 mm
- Without stackable frame

	Dimensions W x D x H (mm)	Product code
SiKo 120/250/60 oR FG LB/SG	120 x 250 x 60	7500809
SiKo 240/250/60 oR FG LB/SG	240 x 250 x 60	7500645
SiKo 320/115/60 oR LB/SG	320 x 115 x 60	7500683
SiKo 320/230/60 oR FG LB/SG	320 x 230 x 60	7500730
SiKo 360/250/60 oR FG LB/SG	360 x 250 x 60	7515007
SiKo 480/250/60 oR FG LB/SG	480 x 250 x 60	7500599
SiKo 480/250/100 oR FG LB/SG	480 x 250 x 100	7515006
SiKo 480/300/60 oR FG LB/SG	480 x 300 x 60	7500729

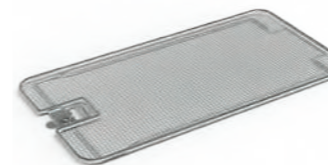

Lid for mesh trays and mesh baskets with drop handles

- With sash lock
- Electropolished stainless steel

	For article/model	Mesh size mm	Dimensions W x D x H (mm)	Product code
Lid 480/250/16	Wire mesh tray	4.64 x 4.64	480 x 250 x 16	7500911
Lid 240/250/16	Wire mesh tray	4.64 x 4.64	240 x 250 x 16	7500912
Lid 240/250/16	Mesh basket with perforated sides	6 x 6	240 x 250 x 16	7515645
Lid 480/250/16	Mesh basket with perforated sides	6 x 6	480 x 250 x 16	7515599



Accessories for mesh trays and mesh baskets

Mesh trays and mesh baskets can be equipped with special accessories for specific applications. Not least among these are the practical 1-2-3-Racks for safely accommodating sensitive instruments.



1-2-3-Rack instrument fixing set

This range of accessories offers perfectly fitted solutions for the protection, safe storage and provision of sensitive instruments. With the 1-2-3-Racks they can be fastened or released with just one movement.

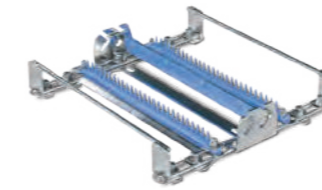
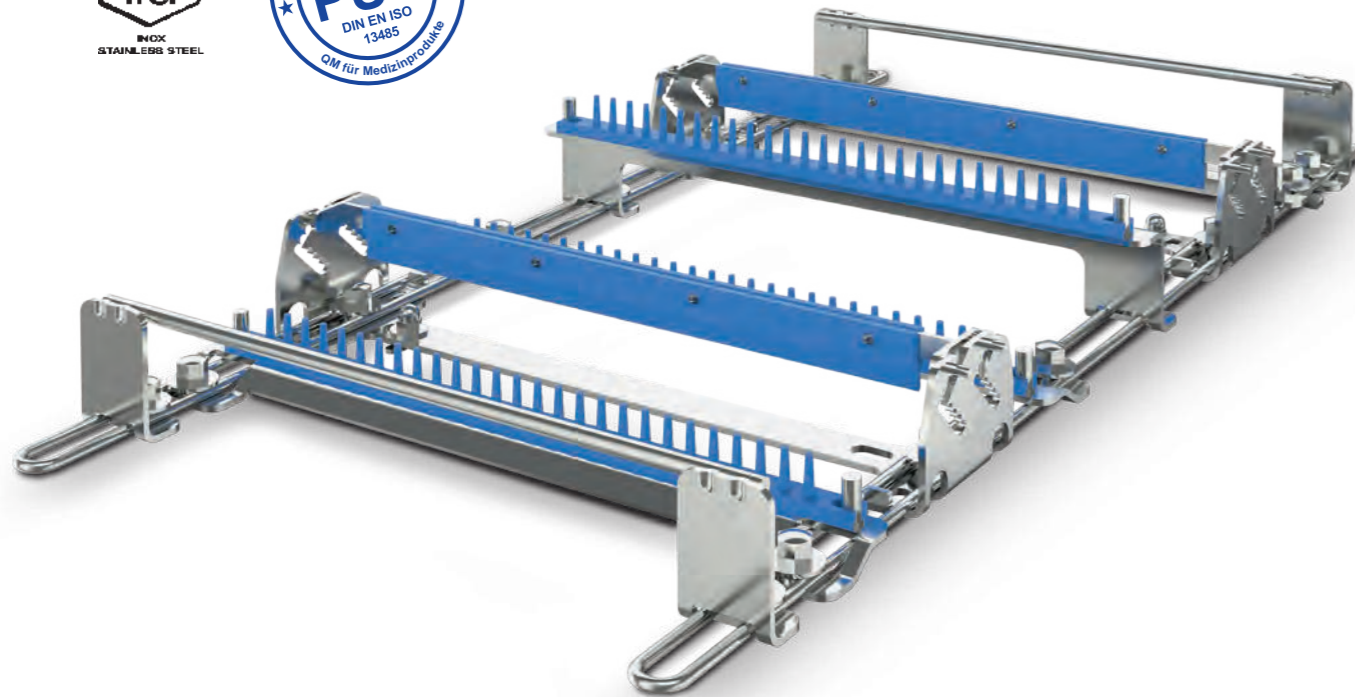

1-2-3-Rack Model 1 instrument fixing set

- For mesh basket with perforated sides
- For all common instruments
- Electropolished stainless steel

	For mesh size (mm)	Dimensions W x D x H (mm)	Product code
FIX/Instr R1 SiScha/240	240	227 x 225 x 40	7501397

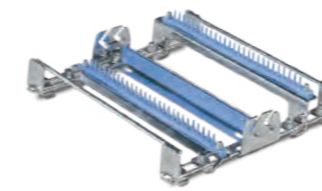

1-2-3-Rack Model 2 instrument fixing set

- For mesh basket with perforated sides
- For bayonet instruments
- Electropolished stainless steel

	For mesh size (mm)	Dimensions W x D x H (mm)	Product code
FIX/Instr R2 SiScha/240	240	227 x 225 x 40	7501398



1-2-3-Rack Model 3 instrument fixing set

- For mesh basket with perforated sides
- For all common instruments
- Electropolished stainless steel

	For mesh size (mm)	Dimensions W x D x H (mm)	Product code
FIX/Instr R3 SiScha 480	480	467 x 225 x 40	7501399



1-2-3-Rack Model 4 instrument fixing set

- For mesh basket with perforated sides
- For all common instruments
- Electropolished stainless steel

	For mesh size (mm)	Dimensions W x D x H (mm)	Product code
FIX/Instr R4 SiScha 480	480	467 x 225 x 40	7501400

Accessories for mesh trays and mesh baskets

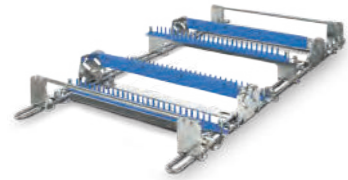

1-2-3-Rack Model 5 instrument fixing set

- For mesh basket with perforated sides
- For general and bayonet instruments
- Electropolished stainless steel

	For mesh size (mm)	Dimensions W x D x H (mm)	Product code
FIX/Instr R5 SiScha 480	480	467 x 225 x 40	7501401



1-2-3-Rack Model 6 instrument fixing set

- For mesh basket with perforated sides
- For long-shafted instruments
- Electropolished stainless steel

	For mesh size (mm)	Dimensions W x D x H (mm)	Product code
FIX/Instr R6 SiScha 510	510	460 x 232 x 155	7501402



1-2-3-Rack Model 7 instrument fixing set

- For mesh basket with perforated sides
- For shafted instruments
- Electropolished stainless steel

	For mesh size (mm)	Dimensions W x D x H (mm)	Product code
FIX/Instr R7 SiScha 240	240	220 x 232 x 155	7501421



Sign holder for mesh trays

- Bolt-on
- With fixing material

	For article/model	Dimensions W x D x H (mm)	Product code
Sign holder set 52/25/6	Mesh trays	53 x 12 x 25	7500064



Cable holder for mesh trays

- Package content: 4 units
- Electropolished stainless steel

	Packaging unit	Dimensions W x D x H (mm)	Product code
Cable holder 22/42/47	1 PU = 4 units	22 x 42 x 47	7501173



Label holder

- Stainless steel

	Dimensions W x D x H (mm)	Product code
Label holder 80/40/10	80 x 40 x 10	7504908

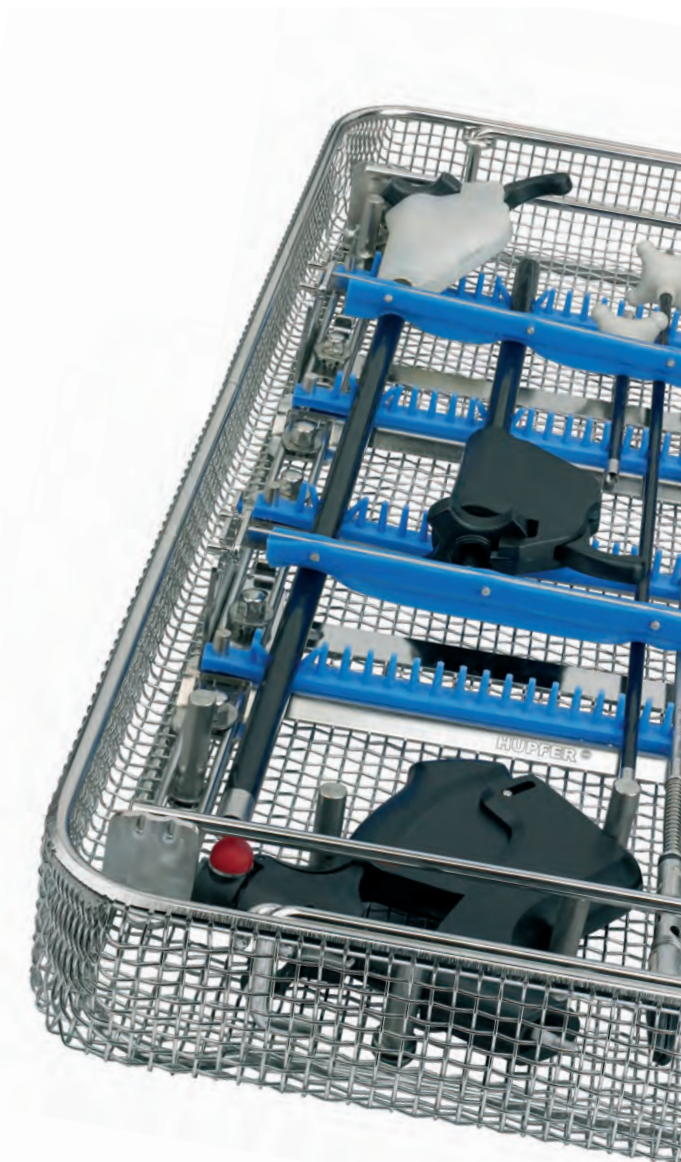

Fine mesh baskets



Small parts are safely stored in these wire baskets and can still be optimally cleaned. The lids are securely connected to the baskets and can be opened and closed with one hand.



Fine mesh basket made of stainless steel wire

- With lid
- With base frame
- Mesh size: 1.6 x 1.6 mm

	Dimensions W x D x H (mm)	Product code
SiKo/KT 80/40/32 BR oG DM mD	80 x 40 x 32	7501282
SiKo/KT 80/40/42 BR oG DM mD	80 x 40 x 42	7501220
SiKo/KT 80/80/42 BR oG DM mD	80 x 80 x 42	7501132



Fine mesh basket made of stainless steel wire

- With lid
- With base frame
- Mesh size: 1.6 x 1.6 mm

	Dimensions W x D x H (mm)	Product code
SiKo/KT 200/100/50 BR oG DM mD	200 x 100 x 50	7501204
SiKo/KT 220/140/54 BR oG DM mD	220 x 140 x 54	7501133
SiKo/KT 274/174/36 BR oG DM mD	275 x 174 x 36	7501135
SiKo/KT 210/150/40 BR oG DM mD	210 x 150 x 42	7501161
SiKo/KT 310/210/40 BR oG DM mD	310 x 214 x 42	7501162



Fine mesh basket with perforated sides

- Removable lid
- With base frame
- Sides are made of finely perforated plate and the base and lid are made of welded mesh
- Mesh size: 6 x 6 mm

	Dimensions W x D x H (mm)	Product code
SiKo/KT 240/250/40 BR oG LB DM mD	240 x 250 x 40	7501150
SiKo/KT 480/250/40 BR oG LB DM mD	480 x 250 x 40	7501151

Baskets for hanging rail

These two basket types allow customised ergonomics and processes in many work areas. They make working materials instantly available and can be refilled or reorganised on the hanging rail in no time at all.



Wire container for hanging rails

- Electropolished stainless steel

	Size	Dimensions W x D x H (mm)	Product code
DCont fGS G3 350/210/200	3	350 x 210 x 200	7502948
DCont fGS G4 230/150/125	4	230 x 150 x 125	7502947



Catheter basket for hanging rail

- Mesh size: 8 x 8 mm
- Electropolished stainless steel

	Dimensions W x D x H (mm)	Product code
KaKo 150/100/200 MW 8/8	150 x 100 x 200	7500150
KaKo 150/100/280 MW 8/8	150 x 100 x 280	7500151
KaKo 150/100/480 MW 8/8	150 x 100 x 480	7500152

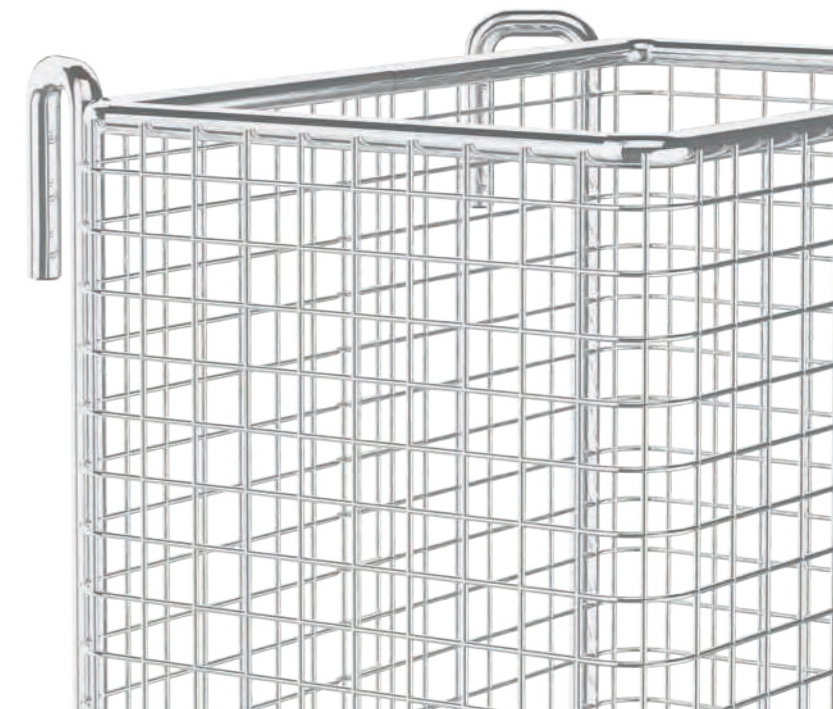

Special baskets



For highly specialised instruments and applications, Hupfer develops mesh baskets and special baskets that are perfectly suited to the situation in the operating theatre. Instrument trays are equipped with custom-made holders and lids so that sensitive instruments are optimally fastened and protected at all times. This means they offer the ideal conditions for safe storage, transport and hygienic handling.



Mesh basket for ENT instruments

- With instrument holders
- Removable lid
- Includes fine mesh basket
- With perforated sides



	Dimensions W x D x H (mm)	Product code
SiKo/KT 240/250/40 oR oG LB SG IA mD	240 x 250 x 40	7501349
SiKo/KT 480/250/40 oR oG LB SG IA mD	480 x 250 x 40	7501350



DaVinci basket

- With instrument holder and lid
- Electropolished stainless steel

	For DaVinci endoscope	Dimensions W x D x H (mm)	Product code
Siko/Endo 640/150/77 oR oG DS mD IA	For SI generation since 2009	640 x 150 x 77	7501473
Siko/Endo 638/392/71 oR oG DS mD IA	For Xi generation since 2014	638 x 392 x 71	7501709

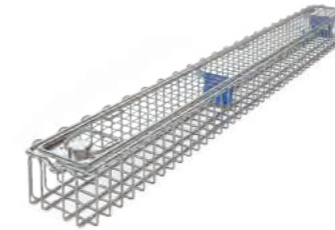

Endoscope basket

- Removable lid
- Secured against coming opening
- Secure sash lock
- With silicone inserts

	Dimensions W x D x H (mm)	Product code
SiKo/Endo 290/80/52 oR oG DS mD 1-fach	290 x 80 x 52	7500479
SiKo/Endo 460/80/52 oR oG DS mD 1-fach	460 x 80 x 52	7500475
SiKo/Endo 670/80/52 oR oG DS mD 1-fach	670 x 80 x 52	7500508



Endoscope basket with holder for accessories and connections

- With additional L-wire for holding accessories and connections
- Removable lid
- Secure sash lock
- With closed wire loops
- With silicone inserts

	Dimensions W x D x H (mm)	Product code
SiKo/Endo 290/80/52 oR oG DS mD L-Dr	290 x 80 x 52	7501334
SiKo/Endo 460/80/52 oR oG DS mD L-Dr	460 x 80 x 52	7501336

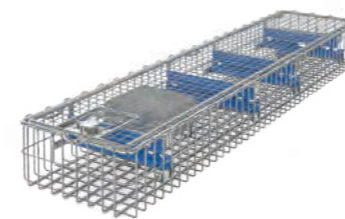

Endoscope basket with optical fibre cable holder

- With fine mesh basket 80 x 40 x 32 mm
- Maximum length of optical fibre: 4500 mm
- Removable lid
- Secure sash lock
- With silicone inserts

	Dimensions W x D x H (mm)	Product code
SiKo/Endo 640/150/77 oR oG DS mD	640 x 150 x 77	7500849



Endoscope basket with 2 compartments

- Removable lid
- Secure sash lock
- With closed wire loops
- With silicone inserts

	Dimensions W x D x H (mm)	Product code
SiKo/Endo 290/80/52 oR oG DS mD 2-fach	290 x 80 x 52	7500831
SiKo/Endo 460/80/52 oR oG DS mD 2-fach	460 x 80 x 52	7500830

Special baskets

In the packing area of a central sterilisation unit, it is important that work is always carried out tidily and in the right order. Here, too, the sturdy, hygienic Hupfer wire baskets do their job reliably and provide perfect protection for the items inside.



Wire basket

- Mesh size: 8 x 8 mm
- With base frame

	Dimensions W x D x H (mm)	Product code
DraKo 100/100/100	100 x 100 x 100	7500900
DraKo 120/120/120	120 x 120 x 120	7500901
DraKo 140/140/140	140 x 140 x 140	7500902
DraKo 160/160/160	160 x 160 x 160	7500903
DraKo 180/180/180	180 x 180 x 180	7500904
DraKo 200/200/200	200 x 200 x 200	7500905
DraKo 300/200/200	300 x 200 x 200	7500906
DraKo 400/200/200	400 x 200 x 200	7500907



Instrument tray

- Mesh size: 10 x 10 mm
- Welded mesh wire thickness: 1.2 mm
- Electropolished stainless steel

	Dimensions W x D x H (mm)	Product code
Instrument tray 245/175/100	245 x 175 x 100	7500075

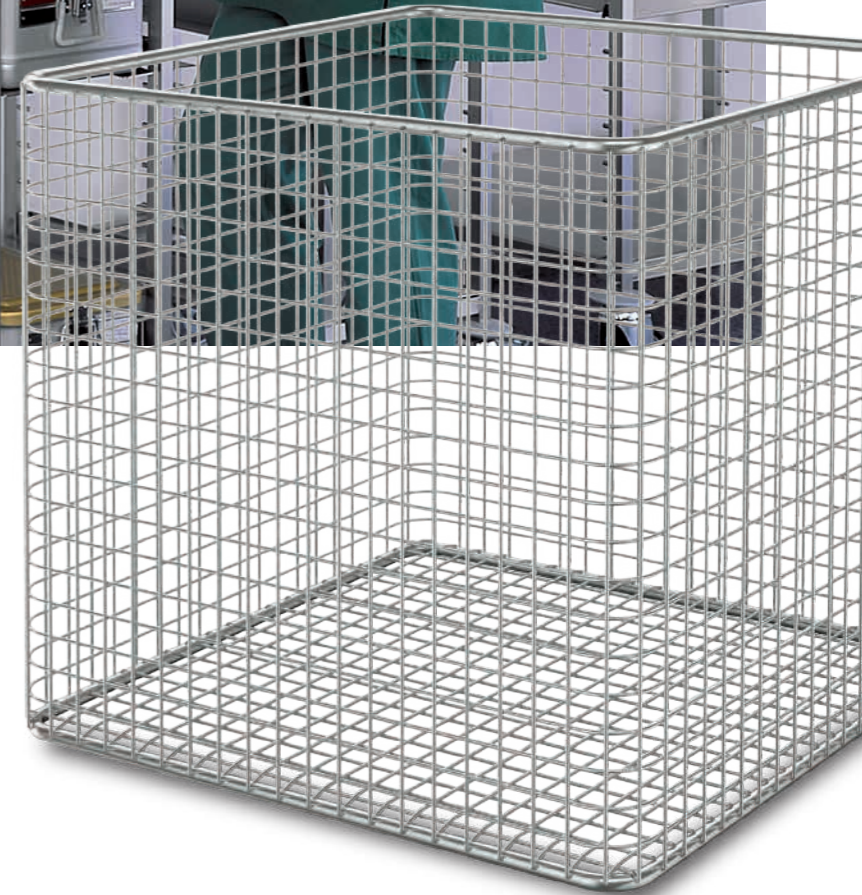

Containers



Wherever wet or dripping materials have to be picked up in clinical or hospital operations, Hupfer offers the right containers made of sturdy polymers or stainless steel for particularly tough applications. Equipped with lids, they ensure problem-free transport and a high level of hygienic safety.

Polymer containers



Disposal container

- With lid
- Temperature resistant from -20 °C to 80 °C
- Polypropylene

	Effective dimensions W x D x H mm	Overall dimensions W x D x H mm	Product code
BEH/Ents PP 600/300/200	550 x 255 x 170	590 x 290 x 192	7500882



Container for used instruments basket

- Hygienic container and lid made of high-quality polypropylene
- Suitable for holding a used instruments basket
- Suitable for washing devices
- Sterilisable at brief maximum temperature of 134 °C

	Dimensions W x D x H (mm)	Product code
Container 300/225/125 with closed lid	300 x 225 x 125	7500076
Container 300/225/125 with slotted lid	300 x 225 x 125	7500077



Container

- Resistant to disinfectant solutions, oils and grease.
- Can briefly withstand 135 °C
- Cannot be sterilised
- Polypropylene

	Dimensions W x D x H (mm)	Product code
BEH/Spec 530/325/100	530 x 325 x 100	7500083
BEH/Spec 530/325/150	530 x 325 x 150	7500247
BEH/Spec 530/325/200	530 x 325 x 200	7500084



Transparent lid for special container

- Can briefly withstand 135 °C
- Resistant to: Disinfectants, oils, grease
- Polymer

	Dimensions W x D (mm)	Product code
Transparent lid 530/325	530 x 325	7500085



Containers

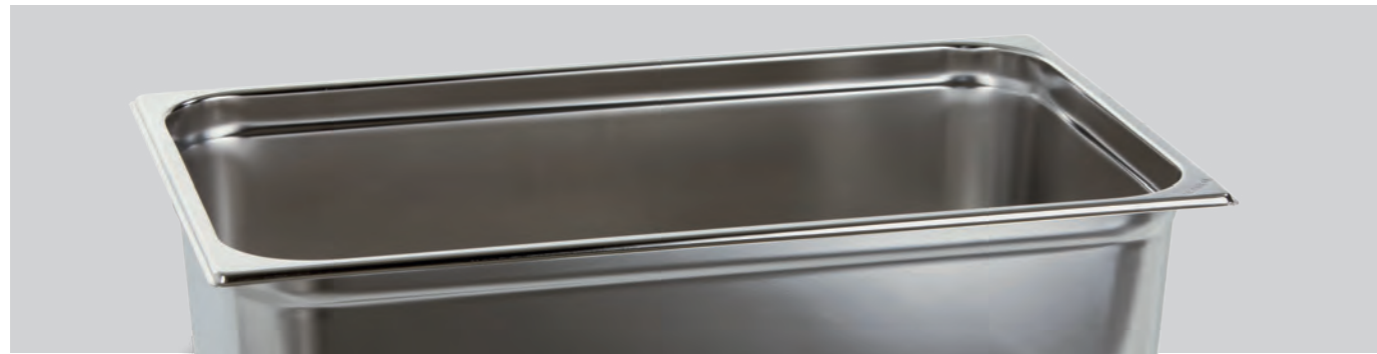

Our Gastronorm containers can handle almost any use or material. They are designed for uncompromisingly tough use. Robust and made of stainless steel, they can handle jobs that containers made of other materials cannot.

Gastronorm containers



Gastronorm container 1/1

- Overall dimensions: 530 x 325 mm
- Material thickness: 0.8 mm
- Stainless steel

	Depth (mm)	Product code
BGN 1/1-20	20	0130602H
BGN 1/1-40	40	0130612H
BGN 1/1-55	55	0132792H
BGN 1/1-65	65	0130622H
BGN 1/1-100	100	0130632H
BGN 1/1-150	150	0130642H
BGN 1/1-200	200	0130652H



Lid for Gastronorm container 1/1

- Stainless steel

	For container size	Product code
BGD 1/1	GN 1/1	0131642H



Transport solutions

Safe and efficient sterile supply cycles are crucial for successful work in clinics, hospitals and sterilisation facilities. Hupfer offers integrated transport solutions that are tailored to diverse and specific requirements, which also offer impressively simple handling and optimum user-friendliness.



Container and sterile supplies transport trolleys



Transport trolleys are an integral part of the supply and disposal of sterile supplies. They ensure hygienically safe transport through unclean areas as well as safe transport of used supplies for disposal. They can also be used flexibly for keeping goods in storage.

The enclosed types of trolley are available in two versions: a cost-optimised standard version and a version with a fully welded body for maximum hygienic safety.



State of the art: fully welded stainless steel body

The sturdy, self-supporting and hygienically fully welded stainless steel body has no undercuts and thus offers ideal conditions for maximum hygiene and ease of cleaning. Transport trolleys with fully welded bodies are designed to be suitable for washing devices.



Cost-optimised: standard stainless steel design

The standard version made of high-quality stainless steel is the ideal combination of proven loading capacity and cost-optimised design. This makes them a reliable and versatile asset.

Container and sterile supplies transport trolleys



Enclosed transport trolleys

Enclosed transport trolleys are the ideal solution for containers, baskets or sterile supplies that need protection when being transported or stored. Their sturdy construction, practical equipment and easy manoeuvring make them reliable companions for daily use.



Sterile goods transport cart

- With 1 solid shelf
- Vertical push handles
- Wing doors with 270° opening angle
- Circumferential door seals

	Design	StU	Dimensions W x D x H (mm)	Product code
STW/VV-3 724/754/1445	Fully welded	3	724 x 754 x 1445	7505984
STW/VV-6 965/754/1445	Fully welded	6	965 x 754 x 1445	7504645
STW/VV-9 1249/754/1440	Fully welded	9	1249 x 754 x 1440	7504646
STW/S-6 965/751/1469	Standard	6	985 x 751 x 1471	7504647
STW/S-9 1249/751/1469	Standard	9	1285 x 751 x 1471	7504648



Case cart for sterile supplies

- Shelf height adjustment without tools
- Transport latch with seal
- Double-walled doors, can be swung and locked up to 270°
- Circumferential door seals

	Version	Design	Shelves	Usable internal dimensions W x D x H (mm)	Dimensions W x D x H (mm)	Product code
STW/S-US-1S 841/769/1000	Low, 1-door	Standard	1	545 x 650 x 635	841 x 769 x 1000	7505990
STW/S-US-2S 1341/769/1000	Low, 2-door	Standard	1	1045 x 650 x 635	1341 x 769 x 1000	7505991
STW/S-US-1T 785/541/1471	High, 1-door	Standard	2	545 x 650 x 1126	785 x 541 x 1471	7505992



Container transport trolleys

- With L-shaped rails for StU
- With U-shaped rails for ISO
- Vertical push handles
- Wing doors with 270° opening angle
- Circumferential door seals

	Design	StU	Dimensions W x D x H (mm)	Product code
CTW/VV-3 724/754/1445	Fully welded	3	724 x 754 x 1445	7505985
CTW/VV-6 965/754/1445	Fully welded	6	965 x 754 x 1445	7504641
CTW/VV-9 1249/754/1440	Fully welded	9	1249 x 754 x 1440	7504642
CTW/S-3 785/751/1471	Standard	3	785 x 751 x 1471	7505989
CTW/S-6 965/751/1469	Standard	6	965 x 751 x 1469	7504643
CTW/S-9 1249/751/1469	Standard	9	1249 x 751 x 1469	7504644
	Design	ISO	Dimensions W x D x H (mm)	Product code
CTW/S-3-ISO 785/751/1471	Standard	3	785 x 751 x 1471	7505987
CTW/S-6-ISO 1285/751/1471	Standard	6	1285 x 751 x 1471	7505988



Container and sterile supplies transport trolleys

Open transport trolleys

This versatile equipment for intermediate storage or transport is ideal for a wide range of applications and working areas. Our open transport trolleys are available in various designs and keep containers, baskets and working materials clearly and visibly available at all times. The high-quality stainless steel design makes them extremely resilient and durable.



Open sterile supplies transport trolley

- 2 fixed and 2 variable shelves
- Antistatic castors
- Stainless steel

	Number of insert compartments for StU	Dimensions W x D x H (mm)	Product code
STW/O-6 755/670/1370	6	755 x 670 x 1370	7504228
STW/O-9 1070/670/1370	9	1070 x 670 x 1370	7504212



Open container transport trolley

- With L-shaped rails for 6 or 9 StU
- With welded cover on top
- Antistatic castors
- Stainless steel

	Number of insert compartments for StU	Dimensions W x D x H (mm)	Product code
CTW/O-6 755/670/1368	6	755 x 670 x 1368	7504225
CTW/O-9 1168/675/1368	9	1168 x 670 x 1368	7504211

Accessories



Gallery rail for STW/CTW

- Stainless steel

	Design	Product code
GA/3-s TW9	Three-sided for STW/CTW 9	7504232
GA/4-s TW9	Four-sided for STW/CTW 9	7504233



Paper clamp for enclosed transport trolley

- For factory fitting
- Bolt fixing
- Stainless steel

	Dimensions W x D x H (mm)	Product code
Paper clamp 90/18/70	90 x 18 x 70	7500895



Hanging rail with 2 hooks

- Stainless steel

	Dimensions W x D x H (mm)	Product code
ANH-LEI 594/40/80	594 x 40 x 80	7504357



Transport securing device for CTW/O

- Pivoting

	Dimensions W x D x H (mm)	Product code
Transport securing device for CTW/O 1050/91/51	1050 x 91 x 51	7500762



Push handle for CTW/O & STW/O

- Assembly height 900 mm above floor

	Dimensions W x D x H (mm)	Product code
Push handle for CTW/O & STW/O	88 x 600 x 85	7500362

Hook trolleys



Hook trolleys

Hupfer hook trolleys provide clearly organised, instant access to many different items and are perfect for transport, intermediate storage and use. Constructed entirely of stainless steel tubes, they can be adapted to the requirements at hand with a variety of equipment options and attachments.



Hook trolleys



Single-sided hook trolley

- Maximum load per hook 30 kg
- Antistatic castors
- Disc bumpers

	Number of hook pairs	Pitch mm	Castor diameter mm	Dimensions W x D x H (mm)	Product code
HAW 605/465/1097 1/2HP	2	400	100	605 x 465 x 1097	7500472
HAW 605/465/1460 1/3HP	3	400	75	605 x 465 x 1460	7500032
HAW 605/620/1620 1/4HP	4	320	75	605 x 620 x 1620	7500092



Double-sided hook trolley

- Maximum load per hook 30 kg
- Antistatic castors
- Disc bumpers

	Number of hook pairs	Pitch mm	Castor diameter mm	Dimensions W x D x H (mm)	Product code
HAW 605/675/1097 2/4HP	2 x 2	400	100	605 x 675 x 1097	7500465
HAW 605/675/1460 2/6HP	2 x 3	400	75	605 x 675 x 1460	7500033
HAW 605/675/1620 2/8HP	2 x 4	320	75	605 x 675 x 1620	7500093



Triple-sided hook trolley

- Maximum load per hook 30 kg
- Antistatic castors
- Disc bumpers

	Number of hook pairs	Pitch mm	Castor diameter mm	Dimensions W x D x H (mm)	Product code
HAW 1000/605/1907 3/15HP	3 x 5	250-320	100	605 x 1000 x 1907	7500870



Medidul double-sided hook trolley

- Maximum load per hook 30 kg
- Antistatic castors
- Disc bumpers

	Number of hook pairs	Pitch mm	Castor diameter mm	Dimensions W x D x H (mm)	Product code
HAW 650/1005/1657 2/4HP Medidul	2 x 4	333	100	650 x 1000 x 1657	7500801



Hook trolleys

Hook trolleys for storing operating theatre steps

These trolleys allow flexible storage and provision of steps of different heights without time-consuming stacking and repacking. Shelves and brackets hung in them can be removed – for example for cleaning – without having to use tools. The curved bend ensures optimum ergonomics and accessibility from both sides.



Ideally sized for three steps of different sizes. The upstand of the stainless steel shelves stops them sliding out.

Operating theatre step trolley

- Robust stainless steel construction
- Three brackets in the lower part
- Antistatic castors
- Upper part with two pairs of hooks on both sides

	Number of hook pairs	Pitch (mm)	Castor diameter mm	Dimensions W x D x H (mm)	Product code
HAW 720/675/1800 2/4HP + Aufl	2 x 2	320	75	720 x 675 x 1800	7505735

Enclosed hook trolley

Reliable protection from dust and other outside conditions. The aluminium frame and stainless steel side panels are light yet very sturdy and able to carry heavy loads. The integrated hook rack can be used to fasten any attachment from the Hupfer product range.

The contents of the trolley are clearly visible behind plexiglass wing doors that are held in place by magnets when closed or at an angle of 270° when opened.

The four swivel castors ensure easy and safe manoeuvring even in the most confined spaces, while the all-round bumper strip prevents damage. Standard hospital disinfectants can be used for cleaning.



The hooks for the attachments are firmly screwed to the rear wall to guarantee they are safely hung.

Suture cart

- Sturdy aluminium frame with three solid stainless steel panels
- Two plexiglass wing doors
- All-round impact protection even when doors are fully open
- Hook rack with 40 mm pitch

	Number of hook pairs	Pitch (mm)	Castor diameter mm	Dimensions W x D x H (mm)	Product code
NMW/G	4	40	125	837 x 576 x 1720	7505730

Accessories for hook trolleys



Medidul L-shaped rails

- Package content: 1 pair
- Bearing face 60 mm
- Stainless steel

	Dimensions W x D x H (mm)	Product code
RG-ESS/L MEDIDUL 594/84/39	84 x 594 x 39	7504213



Medidul U-shaped rails

- Package content: 1 pair
- Bearing face 14 mm
- Stainless steel

	Dimensions W x D x H (mm)	Product code
RG-ESS/U MEDIDUL 36/570/41	36 x 570 x 41	7505009



StU pull-out frame set

- 3/4 extension
- Stainless steel

	Dimensions W x D x H (mm)	Product code
ERS StE 296/595/60	296 x 595 x 60	7504555
ERS ISO 448/595/66	448 x 595 x 66	7501216



Insert shelf

- Perforated
- For placing on L-shaped rails
- Stainless steel

	Dimensions W x D x H (mm)	Product code
Insert shelf 300/600/15	600 x 300 x 15	7504373

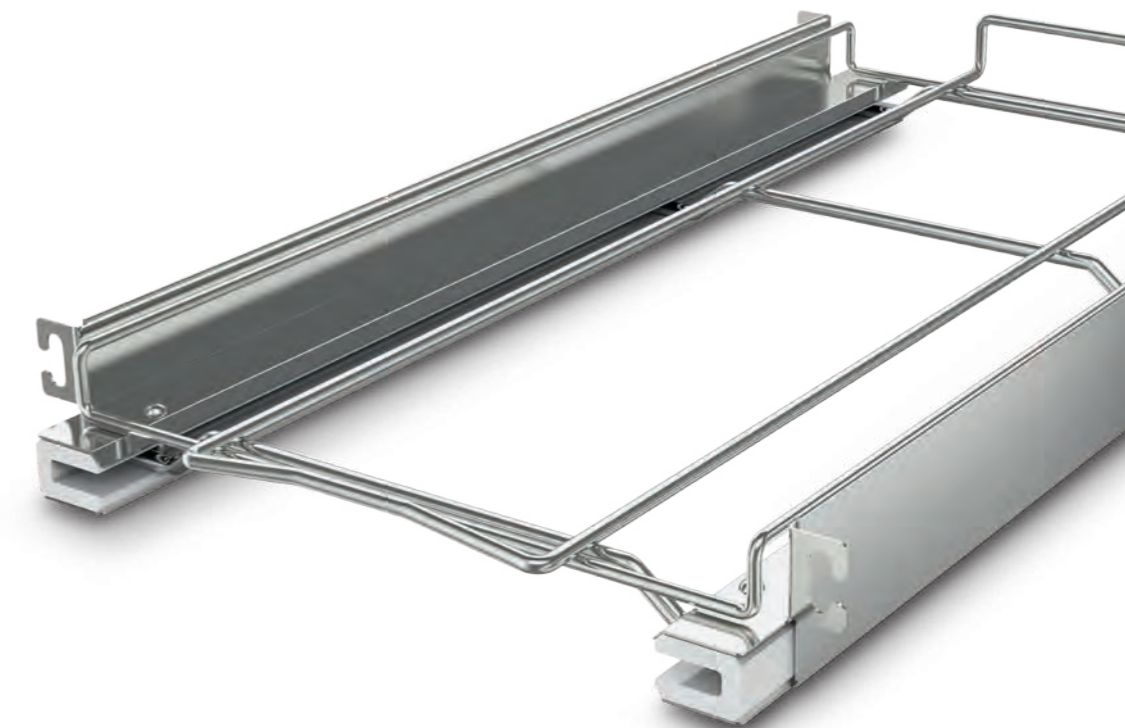

Attachments



Attachments for hook trolleys

The great variety of available attachments means that the hook trolleys can be adapted to many different functions and tasks. They are all characterised by excellent workmanship, durability, functionality and ergonomics for safe and efficient work processes.



Shoe basket

- Up to 5 pairs of shoes
- Electropolished stainless steel

	Dimensions W x D x H (mm)	Product code
SchuKo 585/300/320	585 x 300 x 315	7501457



Wire holder for shoes

- Up to 6 pairs of shoes
- Closed wire loops
- Electropolished stainless steel

	Dimensions W x D x H (mm)	Product code
H-D 600/263/180	600 x 263 x 191	7500452



Shoe rack

- Up to 6 pairs of shoes
- Electropolished stainless steel

	Dimensions W x D x H (mm)	Product code
Shoe rack 600/320/270	600 x 320 x 270	7500374



Roll holder

- For foil rolls of different widths
- Electropolished stainless steel

	Dimensions W x D x H (mm)	Product code
H-D 630/270/194	630 x 270 x 194	7500552



Holder for paper sheets for sterile packaging

- Electropolished stainless steel
- 3 levels

	Dimensions W x D x H (mm)	Product code
Paper holder 1250/240/200	1250 x 240 x 200	7500663



Roll holder with cutter

- Holder for storing, cutting and dispensing sterile packaging in the form of foil rolls
- Complete cut of the tubular foil, even when fully loaded
- Electropolished stainless steel

	Clear internal dimension mm	Cutting width mm	Dimensions W x D x H (mm)	Product code
RHT SB51	529	510	623 x 373 x 294	7507012
RHT SB79	809	790	903 x 373 x 294	7507010
RHT SB114	1159	1140	1253 x 373 x 294	7507011
RHT SB139	1409	1390	1503 x 373 x 294	7507009

Attachments

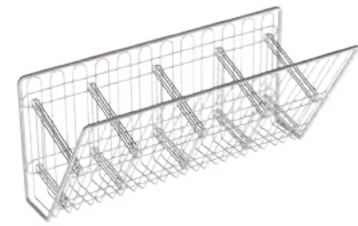

Wire holder for urine bottles

- Up to 4 urine bottles
- Electropolished stainless steel

	Dimensions W x D x H (mm)	Product code
H-D 560/248/272	560 x 248 x 272	7500106

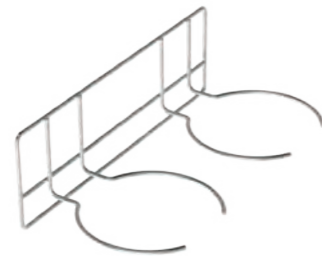

Wire holder for bedpans

- Up to 2 bedpans
- Each wire holder 245 mm in diameter
- Electropolished stainless steel

	Dimensions W x D x H (mm)	Product code
H-D 560/280/180	560 x 280 x 180	7500104



Wire holder for disposable gloves

- Up to 6 disposable glove boxes
- Effective dimensions: 180 x 54 mm (per compartment)
- Electropolished stainless steel

	Dimensions W x D x H (mm)	Product code
H-D 555/139/215	555 x 143 x 215	7500384



Glove dispenser

- Stainless steel

	Dimensions W x D x H (mm)	Product code
Glove dispenser 580/327/271 mm	580 x 327 x 271	7500080



Hanging rail with hooks

- Length of hooks: 150 mm
- Electropolished stainless steel

	Design	Dimensions W x D x H (mm)	Product code
ANH-LEI 555/182/82	With 8 hooks	555 x 186 x 82	7500451
ANH-LEI 636/185/71	With 6 hooks	636 x 186 x 71	7500871



Sterile supplies shelf

- Welded wire loops
- Electropolished stainless steel

	Dimensions W x D x H (mm)	Product code
SteriAbl 555/315/170	555 x 315 x 170	7500440



Wire holder for StU containers

- Electropolished stainless steel

	Dimensions W x D x H (mm)	Product code
H-D 612/316/300	612 x 316 x 300	7500373



Wire holder for tubes and cables

- 11 closed wire loops
- Electropolished stainless steel

	Dimensions W x D x H (mm)	Product code
H-D 600/113/181	600 x 113 x 181	7500460

Attachments



Paper holder

- For paper sheets for sterile packaging
- Electropolished stainless steel

	Dimensions W x D x H (mm)	Product code
Paper holder 560/303/284	560 x 303 x 284	7500478



Shelf

- For notebook or PC monitor
- Electropolished stainless steel

	Dimensions W x D x H (mm)	Product code
Shelf 575/390/155	575 x 390 x 155	7500467



Writing desk

- With inclined writing surface and front upstand
- Stainless steel

	Dimensions W x D x H (mm)	Product code
Writing desk 580/340/225	580 x 340 x 225	7500097



Suture storage unit

- For storage and provision of suture material in 10 standard small packages
- Stainless steel

	Number of shelves	Dimensions W x D x H (mm)	Product code
Suture storage unit 600/170/155	2	600 x 170 x 152	7500170
Suture storage unit 600/170/290	4	600 x 170 x 290	7500079



Wire suture storage unit

- For storage and provision of suture material in standard small packages
- Electropolished stainless steel

	Number of shelves	Capacity Packages	Dimensions W x D x H (mm)	Product code
Suture storage unit 604/135/181	2	10	604 x 135 x 181	7500450
Suture storage unit 604/135/365	4	20	604 x 135 x 365	7500458

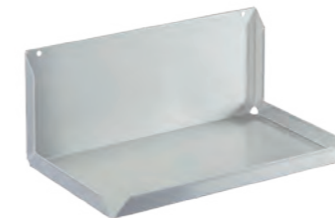

Universal shelf

- With rear wall and side upstands
- For universal use
- Shelf dimensions: 596 x 357 mm
- Stainless steel

	Dimensions W x D x H (mm)	Product code
Universal shelf 600/360/260	600 x 360 x 260	7500086



Universal shelf

- With rear upstand
- For universal use
- Stainless steel

	Dimensions W x D x H (mm)	Product code
Universal shelf 695/350/165	695 x 350 x 165	7502154
Universal shelf 695/450/165	695 x 450 x 165	7502155

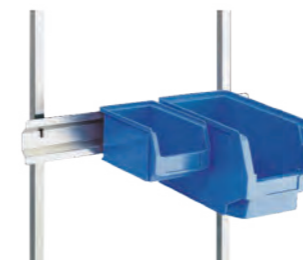

Universal holder for containers

- For wire containers
- For size 3, 4 and 5 polymer storage bins
- Stainless steel

	Design	Dimensions W x D x H (mm)	Product code
Universal holder 655/109/20	Single	655 x 20 x 109	7500448
Universal holder 655/20/329	Double	690 x 20 x 329	7500848

Attachments



Wire container

- For transport, storage and provision of small parts for medical use
- For hanging in universal holder
- Electropolished stainless steel

	Size	Dimensions W x D x H (mm)	Product code
DCont G3 215/350/200	3	215 x 350 x 200	7502945
DCont G4 153/231/125	4	153 x 231 x 125	7502946



Blue polymer storage bin

- For hanging in universal holder
- Temperature resistant from -40 °C to 80 °C
- Polyethylene

	Size	Dimensions W x D x H (mm)	Product code
KCont G3 210/350/200 bl	3	210 x 350 x 200	7502743
KCont G4 150/230/125 bl	4	150 x 230 x 125	7502753
KCont G5 100/170/75 bl	5	100 x 170 x 75	7502763



Green polymer storage bin

- For hanging in universal holder
- Temperature resistant from -40 °C to 80 °C
- Polyethylene

	Size	Dimensions W x D x H (mm)	Product code
KCont G3 210/350/200 gn	3	210 x 350 x 200	7502746
KCont G4 150/230/125 gn	4	150 x 230 x 125	7502756
KCont G5 100/170/75 gn	5	100 x 170 x 75	7502766



Wire holder for polymer StU containers

- For 1 StU container with lid
- Electropolished stainless steel

	For StU container (mm)	Dimensions W x D x H (mm)	Product code
H-D 622/311/272	600 x 300	622 x 291 x 272	7500896



Holder for laundry/waste bags

- For 1 laundry or waste bag 60–70 l
- Electropolished stainless steel

	Dimensions W x D x H (mm)	Product code
H-B 560/310/240	555 x 313 x 240	7500101



Double shelf

- Shelf dimensions: 540 x 190 mm
- Shelf spacing: 190 mm
- Plate thickness: 1.0 mm
- Stainless steel

	Dimensions W x D x H (mm)	Product code
Double shelf 560/200/305	560 x 200 x 305	7500636



Catheter basket for hanging rail

- For hanging in universal holder
- Mesh size: 8 x 8 mm
- Electropolished stainless steel

	Dimensions W x D x H (mm)	Product code
KaKo 150/100/200 MW 8/8	150 x 100 x 200	7500150
KaKo 150/100/280 MW 8/8	150 x 100 x 280	7500151
KaKo 150/100/480 MW 8/8	150 x 100 x 480	7500152



Angled support for sterile goods basket

- Package content: 2 units
- Stainless steel

	Dimensions W x D x H (mm)	Product code
Angled support 35/62/111	35 x 62 x 111	7500289

Transport trolleys

Hupfer transport trolleys



Hupfer offers a range of transport trolleys for many different functions and uses. The range includes all-rounders for a wide variety of tasks as well as special designs for use in and around the operating theatre.

Dedicated workmanship, high-quality materials and practical design guarantee reliability and durability. With robust, smooth-running castors, ergonomic design, easy cleaning and proven functionality, they ensure smooth workflows in everyday hospital life.



Multi-purpose trolleys

The name says it all: Hupfer multi-purpose trolleys are sturdy, flexible and manoeuvrable, making them ideal for a wide range of clinical tasks. They are suitable for transport, intermediate and long-term storage, and much more besides.



Multi-purpose trolleys

- 2 flat, welded shelves
- Antistatic castors
- Height of top shelf: 800 mm

	Panel size	Dimensions W x D x H (mm)	Product code
AZW 625/425/800	625 x 425	689 x 489 x 800	7500468
AZW 720/625/800	720 x 625	783 x 689 x 800	7500470
AZW 920/625/800	920 x 625	983 x 689 x 800	7500469
AZW 1200/625/800	1200 x 625	1263 x 689 x 800	7500661



Transport trolleys



Medical general purpose trolley with four shelves

- Antistatic castors
- 4 shelves
- Payload: 150 kg

	Shelf dimensions mm	Height of top shelf (mm)	Height between shelves (mm)	Dimensions W x D x H (mm)	Product code
MSW 8x5/4	800 x 500	1168	278	895 x 595 x 1264	7504009



MSW medical general purpose trolleys

These robust helpers can be used in a variety of ways for transporting and temporarily storing equipment and working materials. The medical general purpose trolleys are also available with a push handle on one side as an alternative to the standard version.



Medical general purpose trolley with two shelves

- Antistatic castors
- 2 shelves
- Payload: 80 kg

	Shelf dimensions mm	Height of top shelf (mm)	Height between shelves (mm)	Dimensions W x D x H (mm)	Product code
MSW 6x4/2	600 x 400	800	538	695 x 495 x 896	7504128
MSW 8x5/2	800 x 500	855	591	895 x 595 x 949	7504001
MSW 10x6/2	1000 x 600	855	591	1095 x 695 x 949	7504002



Medical general purpose trolley with three shelves

- Antistatic castors
- 3 shelves
- Payload: 120 kg

	Shelf dimensions mm	Height of top shelf (mm)	Height between shelves (mm)	Dimensions W x D x H (mm)	Product code
MSW 6x4/3	600 x 400	800	251	695 x 495 x 896	7504129
MSW 8x5/3	800 x 500	855	278	895 x 595 x 949	7504005
MSW 10x6/3	1000 x 600	855	278	1095 x 695 x 964	7504006

Transport trolleys



Heavy-duty medical general purpose trolley with four shelves

- Antistatic castors
- Payload: 200 kg
- Shelf clearance: 278 mm
- Stainless steel

	Shelf dimensions mm	Height of top shelf (mm)	Height between shelves (mm)	Dimensions W x D x H (mm)	Product code
MSSW 10x6/4	1000 x 600	1232	278	1095 x 695 x 1325	7504120

Heavy-duty medical general purpose trolleys

All-rounder with extra-high payload for extra-heavy transport tasks in special work situations.



Heavy-duty medical general purpose trolley with two shelves

- Antistatic castors
- Payload: 120 kg
- Shelf clearance: 591 mm
- Stainless steel

	Shelf dimensions mm	Height of top shelf (mm)	Height between shelves (mm)	Dimensions W x D x H (mm)	Product code
MSSW 8x5/2	800 x 500	919	591	895 x 595 x 1020	7504107
MSSW 10x6/2	1000 x 600	919	591	1095 x 695 x 1020	7504110



Heavy-duty medical general purpose trolley with three shelves

- Antistatic castors
- Payload: 180 kg
- Shelf clearance: 278 mm
- Stainless steel

	Shelf dimensions mm	Height of top shelf (mm)	Height between shelves (mm)	Dimensions W x D x H (mm)	Product code
MSSW 8x5/3	800 x 500	919	278	895 x 595 x 1020	7504113
MSSW 10x6/3	1000 x 600	919	278	1095 x 695 x 1020	7504114



Transport trolleys

General purpose trolleys

The push bar is designed in accordance with the latest ergonomic principles and makes work easier for staff, protecting them from strain.



Enclosed general purpose trolley

In addition to all the advantages of the Hupfer general purpose trolleys, the enclosed version offers more safety during transport and easy access at the same time.



Ergonomic general purpose trolley with two shelves

- With ergonomic handle
- Payload: 120 kg
- Shelf clearance: 591 mm
- Stainless steel

	Shelf dimensions mm	Height of top shelf (mm)	Height between shelves (mm)	Dimensions W x D x H (mm)	Product code
SW 8x5/2 ERGO	800 x 500	855	591	1035 x 595 x 1269	0133703
SW 10x6/2 ERGO	1000 x 600	855	591	1235 x 692 x 1269	0133723



Enclosed general purpose trolley with two shelves

- With wing doors
- Payload: 80 kg
- Shelf clearance: 591 mm
- Stainless steel

	Shelf dimensions mm	Height of top shelf (mm)	Height between shelves (mm)	Dimensions W x D x H (mm)	Product code
GSW 8x5/2	800 x 500	855	591	900 x 600 x 949	0111934
GSW 10x6/2	1000 x 600	855	591	1100 x 700 x 960	0112054



Ergonomic general purpose trolley with three shelves

- With ergonomic handle
- Payload: 140 kg
- Shelf clearance: 278 mm
- Stainless steel

	Shelf dimensions mm	Height of top shelf (mm)	Height between shelves (mm)	Dimensions W x D x H (mm)	Product code
SW 8x5/3 ERGO	800 x 500	855	278	1035 x 595 x 1269	0133713
SW 10x6/3 ERGO	1000 x 600	855	278	1235 x 695 x 1269	0133733



Enclosed general purpose trolley with three shelves

- With wing doors
- Payload: 120 kg
- Shelf clearance: 278 mm
- Stainless steel

	Shelf dimensions mm	Height of top shelf (mm)	Height between shelves (mm)	Dimensions W x D x H (mm)	Product code
GSW 8x5/3	800 x 500	855	278	898 x 600 x 949	0111964
GSW 10x6/3	1000 x 600	855	278	1000 x 700 x 960	0112084

Accessories for general purpose trolleys



Waste container (large)

- For general purpose and clearing trolleys
- 420 x 200 x 250 mm
- With hooks
- Stainless steel

	Dimensions W x D x H (mm)	Product code
ANH-BEH 420/200/250 SW	420 x 200 x 250	0116192



Three-sided gallery rail

- Three-sided (front side open)
- Gallery height: 50 mm
- Stainless steel

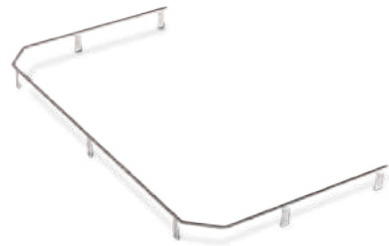

	Shelf dimensions (mm)	Dimensions W x D x H (mm)	Product code
GA/3-s SW6x4 Ø8/599/330/50	600 x 400	599 x 330 x 50	0114506
GA/3-s SW8x5 Ø8/799/430/50	800 x 500	799 x 430 x 50	0114502
GA/3-s SW10x6 Ø8/999/530/50	1000 x 600	999 x 530 x 50	0114503

Four-sided gallery rail

- Four-sided
- Gallery height: 50 mm
- Stainless steel



	Shelf dimensions (mm)	Dimensions W x D x H (mm)	Product code
GA/4-s SW6x4 Ø8/599/399/50	600 x 400	599 x 399 x 50	0114507
GA/4-s SW8x5 Ø8/799/499/50	800 x 500	799 x 499 x 50	0114504
GA/4-s SW10x6 Ø8/999/599/50	1000 x 600	999 x 599 x 50	0114505



Waste bag holder

- For holding 120-litre waste bags
- With rubber seal
- Stainless steel

	For general purpose trolleys	Dimensions W x D x H (mm)	Product code
MHR 120 350/283/736	SW 8 x 5 and 10 x 6	350 x 280 x 736	0114802



Reinforcement bar

- Extra load: 20 kg
- Fully welded
- Stainless steel

	Shelf dimensions (mm)	Dimensions W x D x H (mm)	Product code
VUZ SW 6x4	600 x 400	575 x 397 x 29	0114584
VUZ SW 8x5	800 x 500	775 x 497 x 29	0114582
VUZ SW 10x6	1000 x 600	975 x 597 x 29	0114583

OP equipment trolleys



Mobile instrument stand

- Height adjustable from 715–1200 mm
- Antistatic castors
- Effective dimensions: 530 x 325 mm
- Without insert tray, available as accessory
- Stainless steel

	Dimensions W x D x H (mm)	Product code
Mobile instrument stand 627/400/715-1200	627 x 400 x 715–1200	7500858

OP equipment trolleys

This range for use in and around the operating theatre is tailored to the particularly stringent requirements for this area. High-quality materials and workmanship down to the last detail guarantee maximum safety, reliability and hygiene.



Mobile instrument table

- Panel size: 665 x 665 mm
- 2 hook-on profile rail pairs
- One welded rail pair
- Antistatic castors
- Stainless steel

	Dimensions W x D x H (mm)	Product code
SBT 700/700/900 F	699 x 699 x 902	7500752



Trolley

- Pair of hook-on profile rails
- Welded profile rail pairs
- Antistatic castors
- Stainless steel

	Dimensions W x D x H (mm)	Product code
ESCW 640/385/900	650 x 410 x 900	7500753



Gastronorm container as insert tray

- Overall dimensions: 530 x 325 mm
- Stainless steel

	Height (mm)	Product code
BGN 1/1-20	20	0130602H
BGN 1/1-40	40	0130612H
BGN 1/1-65	65	0130622H



Mobile instrument table

- With removable tabletops
- Frame acts as gallery rail
- Antistatic castors
- Stainless steel

	Dimensions W x D x H (mm)	Product code
IT 625/425/800 F	625 x 425 x 800	7500204
IT 720/625/800 F	744 x 649 x 800	7500205
IT 940/625/800 F	940 x 625 x 800	7500206

OP equipment trolleys



Basket trolleys / basket dispensers

Basket trolleys and basket dispensers offer space for a large number of baskets and facilitate intermediate storage, transport and material storage at the workplace.



Basket trolley for sterile goods baskets

- Up to 2 stacks of StU baskets 600 x 300 mm
- Platform height: 202 mm
- Antistatic castors
- Stainless steel

	Dimensions W x D x H (mm)	Product code
KR 60-60 StE	791 x 676 x 856	7500196



Open-sided ISO and StU basket dispenser

- Platform lowers for constant removal height
- Stainless steel

	Dimensions W x D x H (mm)	Product code
OKO 61-41 ISO/SRI	715 x 803 x 900	7504874
OKO 61-61 StE	800 x 715 x 900	7504872

Paper holders

Whether in the operating theatre or the central sterilisation facility, Hupfer paper stands are safe and easy to use and provide practical and reliable assistance wherever they are needed.



Paper holder trolley

- With 4 holder frames Ø 25 mm
- Frame height: 905 mm
- Stainless steel

	Dimensions W x D x H (mm)	Product code
Paper holder 1410/725/995	1416 x 718 x 995	7500371



Wire shelf for paper holder

- Electropolished stainless steel

	Dimensions W x D x H (mm)	Product code
Wire shelf 1130/663/154	1130 x 663 x 154	7500372

OP equipment trolleys

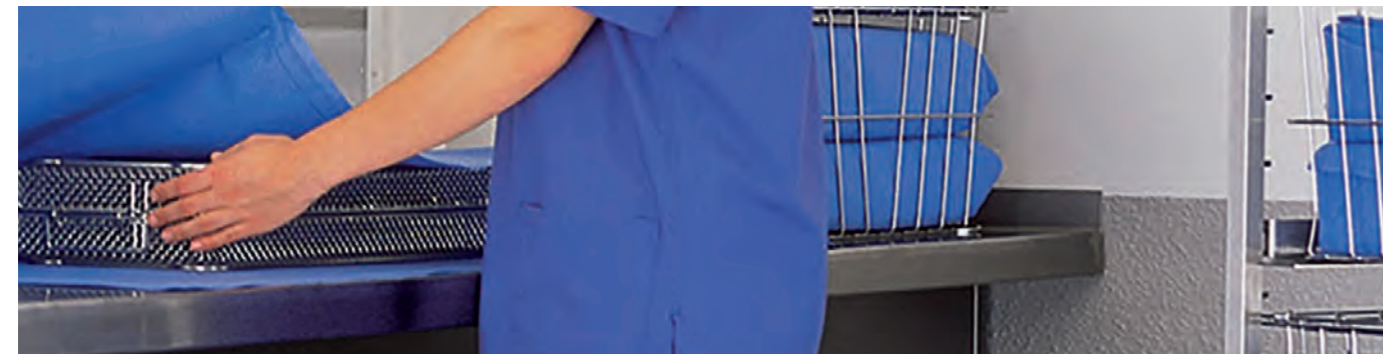

Single-ended platform trolley

- Maximum load: 500 kg
- With flat shelf
- Stainless steel

	Platform dimensions (mm)	Dimensions W x D x H (mm)	Product code
STWP 8.5x5	850 x 500	970 x 500 x 944	0114192
STWP 10x7	1000 x 700	1123 x 700 x 943	0114212



Heavy-duty transport trolley

- Maximum load: 500 kg
- Platform height: 265 mm
- Stainless steel

	Platform dimensions (mm)	Dimensions W x D x H (mm)	Product code
TW/s 12 x 6	1200 x 600	1366 x 660 x 1054	0162578



Platform trolley

- With deep shelf
- Shelf height: 287 mm
- Stainless steel

	Platform dimensions (mm)	Dimensions W x D x H (mm)	Product code
PW 8x5	800 x 500	895 x 595 x 1012	0112602
PW 10x6	1000 x 600	1095 x 695 x 1012	0112632



Platform trolley

- With flat shelf
- Shelf height: 245 mm
- Stainless steel

	Platform dimensions (mm)	Dimensions W x D x H (mm)	Product code
PW 5.4x5.4	545 x 545	708 x 606 x 1024	0112662
PW 8.2x5.4	820 x 545	983 x 605 x 1020	0112692



Platform trolleys

Hupfer platform trolleys are versatile and extremely resilient helpers, from transport to intermediate storage and provision at the place of use. As single-ended or heavy-duty transport trolleys with a particularly sturdy construction, they can easily cope with heavy loads.

Känguruh system®

The Hupfer Känguruh System® helps reliably ensure that clean and unclean zones are kept separated. Because it eradicates the need for repacking, work processes are faster and the amount of work required is reduced. Ergonomic handling and the precise interaction of all components guarantee safe and clearly organised processes at all times, ensuring maximum hygiene throughout the sterile supply cycle.



Känguruh system®



Integrated system for storage, transport and provision of sterile supplies

Depending on the location, the **push-in rack** is loaded with contaminated or sterile instruments. It has space for baskets and containers in StU or ISO format and keeps the instruments safe, from cleaning and sterilisation through to storage and distribution. A matching **platform** can also be used to store push-in racks, which among other things can be ideally integrated in the Hupfer Norm 5 shelving system.

The loaded push-in rack is pushed from the **transfer trolley** into the steriliser. After sterilisation, the push-in rack with the instruments can be moved directly into the **transport trolley** and then safely taken to the storage location or to the operating theatre for further use – all without time-consuming repacking and hand contact.



Transfer via pass-through chamber



Docking on to a transfer threshold

Advantages at a glance:

- Integrated system for storage, transport and provision of sterile supplies
- No time-consuming repacking after cleaning, disinfection and testing
- Highest-quality stainless steel for toughest use and maximum hygiene
- Excellent ergonomics and flexible handling
- All operations without hand contact on basket or container
- Optimised work efficiency and hygienic safety
- Transfer dollies, transport trolleys, platforms and push-in racks are available in many variants and special versions
- Also adaptable to driverless transport systems (DTS)



Driverless transport system with Känguruh system® transport trolleys



External transport by lorry

Känguruh system®

KÄNGURUH SYSTEMS®

03



Custom planning and configuration

From planning through to configuration, the Känguruh system® is adapted to the logistical requirements and the existing technical equipment. For example, in addition to the standard version, the transfer dollies are also available in fully welded versions for maximum hygienic safety. The entire system can also be integrated into special in-house transport systems right up to driverless transport systems (DTS).



Intelligent solutions down to the finest detail

The Hupfer Känguruh system® is the result of many years of experience in sterile supplies logistics and the latest design and manufacturing expertise. Its unique functionality and the high quality of materials and workmanship are not only reflected in the overall concept, but also in many practical details designed for efficient and ergonomic operation.



Lengthwise and/or transverse docking are available optionally.



L- or U-shaped rails for optimum matching to StU baskets and containers as well as ISO baskets.

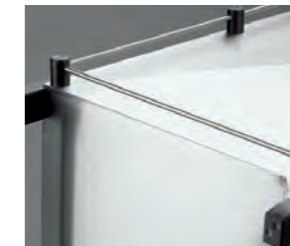

With the optional 3 or 4-sided gallery rail, the top of the trolley can also be used for storage and transport.



Transport trolleys can be easily labelled with the optional paper clamp. Sign holders in various formats are available on request.



The transport trolley is also available as a general-purpose transport trolley (ATW) for transporting a wide variety of goods.



The optional central brake allows fixing in position with just one foot movement.



Wired shelves and perforated plates for placing on L rails allow a wide variety of goods and containers to be stored. Optional pull-out frame sets make work even easier.



For transport by truck, the wagons are available with special skirting protection on request.



The optional transport latch with sealing option provides maximum security for the sterile supplies.



The optional sign holders provide the clearest possible overview.

Känguruh system®



Transfer trolley

- Secure locking on the transport trolley
- Secure locking of the push-in rack
- Optional design compatible with sterilisation and washing systems

StU • 600 x 300 mm

	StU	Dimensions W x D x H (mm)	Product code
KÄ-ÜW 3StE 717/425/909 SH260	3	717 x 425 x 909	7504618
KÄ-ÜW 6StE 854/677/909 SH260	6	854 x 677 x 909	7504621
KÄ-ÜW 9StE/2xISO 1137/677/909 SH260	9	1137 x 677 x 909	7504627

ISO • 600 x 400 mm

	ISO	Dimensions W x D x H (mm)	Product code
KÄ-ÜW 1xISO 717/560/909 SH260	3	717 x 560 x 909	7504651
KÄ-ÜW 9StE/2xISO 1137/677/909 SH260	6	1137 x 677 x 909	7504627

Platform

- Stainless steel
- For parking and storing the push-in rack
- Base cladding on request

StU • 600 x 300 mm

	StU	Dimensions W x D x H (mm)	Product code
KÄ-UG 6StE 850/700/307 SH260	2 x 3 / 1 x 6	850 x 700 x 307	7504619
KÄ-UG 9StE 1130/700/307 SH 260	9	1130 x 700 x 307	7504628

ISO • 600 x 400 mm

	ISO	Dimensions W x D x H (mm)	Product code
KÄ-UG 9StE 1130/700/307 SH 260	2 x 1 ISO or 1 x 2 ISO	1130 x 700 x 307	7504628



Transport trolley

- Stainless steel
- Various castor versions and equipment
- Traction operation with coupling/drawbar (also friction-damped)

StU • 600 x 300 mm

	Design	StU	Dimensions W x D x H (mm)	Product code
KÄ-TW/VV 3StE 724/754/1444 SH260	Fully welded	3	724 x 754 x 1444	7505986
KÄ-TW/S 6StE 965/751/1471	Standard	6	965 x 751 x 1471	7504659
KÄ-TW/VV 6StE 965/754/1444 SH260	Fully welded	6	965 x 754 x 1444	7504617
KÄ-TW/S 9StE 1285/751/1471 SH 260	Standard	9	1285 x 751 x 1471	7504660
KÄ-TW/VV 9StE 1249/754/1434 SH260	Fully welded	9	1249 x 754 x 1434	7504624

ISO • 600 x 400 mm

	Design	ISO	Dimensions W x D x H (mm)	Product code
KÄ-TW/VV 3StE 724/754/1444 SH260	Fully welded	3	724 x 754 x 1444	7505986
KÄ-TW/S 9StE 1285/751/1471 SH 260	Standard	6	1285 x 751 x 1471	7504660
KÄ-TW/VV 9StE 1249/754/1434 SH260	Fully welded	6	1249 x 754 x 1434	7504624



Push-in rack

- Stainless steel
- For holding StU and ISO baskets or containers

StU

	StU	Dimensions W x D x H (mm)	Product code
KÄ-EG 3StE 355/615/1041 L-Sch	3	355 x 615 x 1041	7504595
KÄ-EG 6StE 685/615/1041 3 DR	6	685 x 615 x 1041	7504620
KÄ-EG 6StE 685/615/1041 L-Sch	6	685 x 615 x 1041	7504622
KÄ-EG 9StE 1015/615/1041 3 DR	9	1015 x 615 x 1041	7504625
KÄ-EG 9StE 1015/600/1041 L-Sch	9	1015 x 600 x 1041	7504626

ISO • 600 x 400 mm

	ISO	Dimensions W x D x H (mm)	Product code
KÄ-EG ISO 455/615/1041 8U-Sch	3	455 x 615 x 1041	7504649
KÄ-EG ISO 885/615/1041 16U-Sch	6	885 x 615 x 1041	7504650

Shelving systems

Hupfer shelving systems offer tailor-made solutions for storing, stocking and providing everything from sterile supplies and working materials to consumables and equipment. The large selection of sizes, shelves, possible combinations, material and equipment versions means there are no limits when it comes to configuring complex shelving systems.



Norm shelving: designed for flexibility

Hupfer Norm shelving can be precisely adapted to all spatial conditions, which means that optimum and therefore economical use is made of the available storage space. The principle: Every Hupfer Norm standard shelving unit consists of a basic unit (2 uprights, 4 shelves, 1 cross brace).

This basic shelving unit is expanded with the extension unit (1 upright, 4 shelves). If a 90° corner connection is required, this is done using corner hooks – without the need for superfluous and space-consuming uprights.



The basic shelving unit
For each basic shelving unit which is set up individually, you need two uprights.



The extension unit
For the extension unit, you only need one upright for each additional section (i.e. 3 uprights for 2 sections – see diagram). Almost all shelving units can be extended in increments of 10 cm.

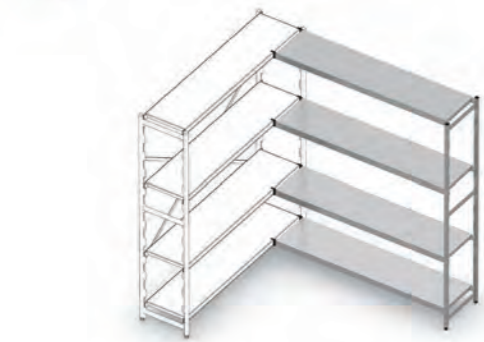

The 90° corner connection
For every shelving system, the 90° corner connection uses simple clip-on corner hooks (2 for each shelf). No superfluous uprights are necessary.

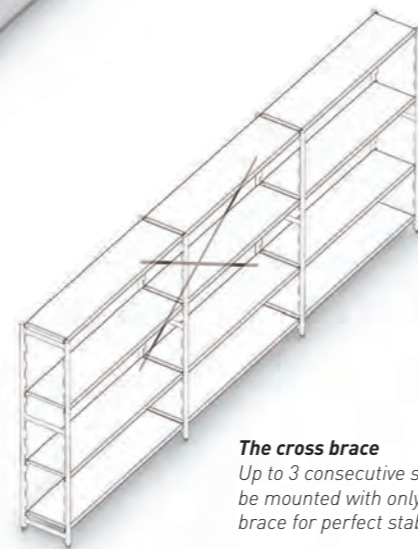

The cross brace
Up to 3 consecutive sections can be mounted with only one cross brace for perfect stability.



The double shelving unit
With back-to-back assembly, you can increase the usable depth of the section. Because the uprights are bolted to each other, there is one less cross brace than with the basic set-up.

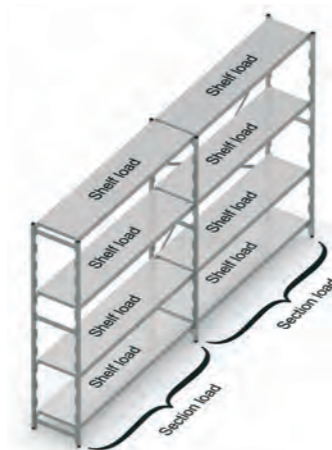

The shelf load is the evenly distributed load on a single shelf.

The sum of the shelf loads in a section may not exceed the section load.



Well thought out down to the last detail



Robust
The robust stainless steel construction, high-quality components and high manufacturing quality ensure reliability and durability under the toughest conditions.



Clearly arranged
Easily attachable shelf dividers help keep things tidy. They are available for shelves in depths of 55 and 600 mm.



Variable
Even after assembly, the individual shelves can be exchanged or repositioned according to the stored items, without requiring any tools.

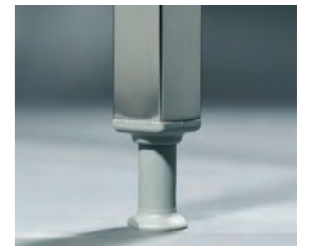

Stable
The standard height-adjustable screw feet compensate for uneven floors up to 25 mm.



Hygienic
The flat cross-connections are positively connected to the uprights using a state-of-the-art, patented method. This prevents blind spots and cavities to allow thorough cleaning without any problems.



Versatile
Solid shelves, polymer shelves or stainless steel louvered shelves are available for different requirements.



Protected
The versions with flat roof, floor base and side and rear cladding offer reliable protection from dust and dirt.



Mobile
Some types of shelf are available on request with optional castors so that they easily can be moved, for cleaning for example.

Norm 5 shelving unit

The Norm 5 shelving unit sets the standards in terms of performance, hygiene and easy cleaning. Robust, versatile and long-lasting, this shelving system is available for every conceivable storage item.



SHELVING SYSTEMS
04



Norm 5 shelving unit with louvred shelves

- Stainless steel
- Number of shelves per section
- With cross brace

Maximum section load: 600 kg

Depth (mm)	Total width / shelf height 1800 mm									
	300	1000	1200	1500	1775	1975	2375	2775	2975	3450
400										
500										
600										

Maximum section load: 1200 kg

Depth (mm)	Total width / shelf height 1800 mm									
	300	1000	1200	1500	1775	1975	2375	2775	2975	3450
400										
500										
600										



Norm 5 shelving with solid shelves

- Stainless steel
- Number of shelves per section
- With cross brace

Maximum section load: 600 kg

Depth (mm)	Total width / shelf height 1800 mm									
	300	1000	1200	1500	1775	1975	2375	2775	2975	3450
400										
500										
600										

Maximum section load: 1200 kg

Depth (mm)	Total width / shelf height 1800 mm									
	300	1000	1200	1500	1775	1975	2375	2775	2975	3450
400										
500										
600										

Versions with other sizes and dimensions can be found at www.hupfer.com

Norm 5 shelving unit



Norm 5 shelving unit with wired shelves

- Stainless steel
- Number of shelves per section
- With cross brace

Maximum section load: 600 kg

Depth (mm)	Total width / shelf height 1800 mm									
300	1000	1200	1500	1775	1975	2375	2775	2975	3450	3650
400										
500										
600										

Maximum section load: 1200 kg

Depth (mm)	Total width / shelf height 1800 mm									
300	1000	1200	1500	1775	1975	2375	2775	2975	3450	3650
400										
500										
600										
600										

Norm 5 shelf load		
Shelf type	Width (mm)	Shelf load with equally distributed load (kg)
Louvred shelf	600-1000	150
	1200-1500	100
Solid shelf	600-1000	150
	1200	160
	1400-1500	125
Wired shelf	600-1000	180
	1200	150
	1400-1500	100



NORM 5 upright

- Stainless steel
- Pitch 150 mm

Maximum section load: 600 kg

Height (mm)	Upright depth 300 mm	Upright depth 400 mm	Upright depth 500 mm	Upright depth 600 mm
	Product code	Product code	Product code	Product code
1200	0101007	0101017	0101037	0101047
1400	0101077	0101087	0101107	0101117
1600	0101147	0101157	0101177	0101187
1800	0101217	0101227	0101247	0101257
2000	0101287	0101297	0101317	0101327

Maximum section load: 1200 kg

Height (mm)	Upright depth 400 mm	Upright depth 500 mm	Upright depth 600 mm
	Product code	Product code	Product code
1800	0101225	0101245	0101255
2000	0101295	0101315	0101325



Norm 5 shelving unit



NORM 5 louvred shelf

■ Stainless steel

Width (mm)	For upright depth 300 mm	For upright depth 400 mm	For upright depth 500 mm	For upright depth 600 mm
	Product code	Product code	Product code	Product code
600	0101537	0101547	0101567	0101577
800	0101607	0101617	0101637	0101647
900	0101677	0101687	0101707	0101717
1000	0101747	0101757	0101777	0101787
1200	0101817	0101827	0101847	0101857
1400	0101887	0101897	0101917	0101927
1500	0101957	0101967	0101987	0101997



NORM 5 solid shelf

■ Stainless steel

Width (mm)	For upright depth 300 mm	For upright depth 400 mm	For upright depth 500 mm	For upright depth 600 mm
	Product code	Product code	Product code	Product code
600	0102432	0102442	0102462	0102472
800	0102502	0102512	0102532	0102542
900	0102572	0102582	0102602	0102612
1000	0102642	0102652	0102672	0102682
1200	0102712	0102722	0102742	0102752
1400	0102782	0102792	0102812	0102822
1500	0102852	0102862	0102882	0102892



NORM 5 wired shelf

■ Electropolished stainless steel

Width (mm)	For upright depth 300 mm	For upright depth 400 mm	For upright depth 500 mm	For upright depth 600 mm
	Product code	Product code	Product code	Product code
600	0101532	0101542	0101562	0101572
800	0101602	0101612	0101632	0101642
900	0101672	0101682	0101702	0101712
1000	0101742	0101752	0101772	0101782
1200	0101812	0101822	0101842	0101852
1400	0101882	0101892	0101912	0101922
1500	0101952	0101962	0101982	0101992



NORM 5 cross brace

■ Requires one in every third section
■ Stainless steel

Stainless steel Suitable for all shelf widths	Product code
	0103072



Norm 5 cross brace • back-to-back

■ Requires 1 in every 3rd section
■ Stainless steel

Stainless steel Suitable for all shelf widths	Product code
	0103082



Norm 5 shelving unit



Push-through protection

- For rear attachment
- Electropolished stainless steel

For shelf width (mm)	Product code
1000	0117414
1200	0117415
1500	0117417

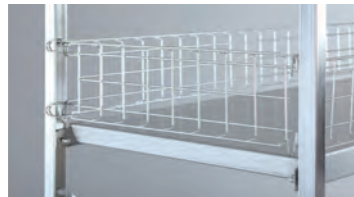

Push-through protection

- Electropolished stainless steel
- For side attachment

Depth (mm)	Product code
500	0117402
600	0117403



Bracing bar

- Stainless steel
- As an alternative to the cross brace for loading the shelf from both sides
- With fixing material
- 4 long rails required per section

Width (mm)	Product code
600	0117022
800	0117023
900	0117024
1000	0117025
1200	0117026
1400	0117027
1500	0117028



Corner hooks

- For corner connections
- For louvred shelves and solid shelves

Product code
0203126



Corner hooks

- For corner connections
- For wired shelves

Product code
0103122

Norm 5 shelving unit



Shelf divider

- Stainless steel
- For enclosed systems

For shelf depth (mm)	Dimensions W x D x H (mm)	Product code
500	458 x 100 x 210	7504221
600	558 x 100 x 210	7504220



Shelf railing

- Stainless steel
- To stop items falling out of the front or back
- With polymer end caps

Width (mm)	Product code
600	0115242
800	0115243
900	0115244
1000	0115245
1200	0115246
1400	0115247
1500	0115248



Shelf railing holder

- Stainless steel
- Freely height-adjustable
- For use with shelf railing

Product code
0115252



Weight distribution plate

- Aluminium

Dimensions W x D x H (mm)	Product code
115 x 115 x 6	0203142



Hanging rail support

- Stainless steel
- For attaching hook rails
- Also to secure the stored items from the sides

	For upright depth 300 mm	For upright depth 400 mm	For upright depth 500 mm	For upright depth 600 mm
Product code	Product code	Product code	Product code	
	0123582	0123592	0123602	0123612



Hook rail

- Aluminium
- For hanging between two uprights
- For attaching hooks
- Universal rail 45 x 10 mm

For shelf width (mm)	Product code
600	0203162
800	0203172
900	0203182
1000	0203192
1200	0203202
1400	0203212
1500	0203222

Norm 5 shelving unit



Ceiling or floor fixing attachment

- Stainless steel
- For additional securing of shelves.
- Without fixing material

Product code
0103152



Wall mounting

- Stainless steel
- For upright

Product code
0116032



Wall fixing

- Stainless steel
- For uprights against walls with coving
- For 25 x 25 mm tube
- Without fixing material

Dimensions W x D x H (mm)
85 x 68 x 58

Product code
0116031



Wire shelf

- Stainless steel

	Maximum load (kg)	Dimensions W x D x H (mm)	Product code
RG-BR/N5 1000/550/300	200	990 x 550 x 300	0114452
RG-BR/N5 1200/550/300	200	1200 x 550 x 300	0114492



Norm 5 Medidul shelving unit

This version of the tried-and-tested shelving system is specially designed for operating theatres and sterile supplies storage areas. Whether in soft packaging in baskets or in containers – sterile supplies are stored safely and clearly on U-shaped rails or L-shaped rails.



SHELVING SYSTEMS
04



Norm 5 Medidul upright

■ Stainless steel

Maximum section load: 600 kg

Height (mm)	For upright depth 300 mm	For upright depth 400 mm	For upright depth 500 mm	For upright depth 600 mm
	Product code	Product code	Product code	Product code
1800	-	7505114	-	7505105
2000	7505113	7505115	7505117	7505106



Norm 5 Medidul solid shelf

■ Stainless steel

	Width (mm)	Product code
A-GS 355/600	355	7505004
A-GS 455/600	455	7505008



Norm 5 cross brace • back-to-back

■ Requires one in every third section
■ Stainless steel

	Product code
RG-KV/N5 Medidul	7505019
RG-KV/N5 Medidul ISO	7505611
RG-KV/N5 Medidul StU	7505612



Norm 5 Medidul shelving unit



Bracing bars

- Stainless steel
- For uprights with 600 kg section load
- For uprights with 75 mm pitch
- Packaging unit: 4 per section

	Design	Width (mm)	Product code
H-A/600 355	For StU standard	355	7505024
H-A/600 455	For ISO standard	455	7505025

For upright depth
600 mm



Profile rails

- Stainless steel
- Shelf width: 60 mm
- Packaging unit: 2 units

	Dimensions W x D x H (mm)	Product code
RG-ESS/L MEDIDUL 594/84/39	594 x 84 x 39	7504213



U-shaped rails

- Stainless steel
- Shelf width: 14 mm
- Packaging unit: 2 units

	Dimensions W x D x H (mm)	Product code
RG-ESS/U MEDIDUL 36/570/41	36 x 570 x 41	7505009



Pull-out frame

- For DIN StU containers and baskets
- For ISO containers and baskets

Pull-out frame set		Dimensions W x D x H (mm)	Product code
ERS StE 296/595/60	For StU standard	296 x 595 x 60	7504555
ERS ISO 448/595/66	For ISO standard	448 x 595 x 66	7501216



Insert shelf

- Stainless steel
- Perforated

	Dimensions W x D x H (mm)	Product code
Perforated insert shelf 300/600/15	300 x 600 x 15	7504373



Label holder

- Electropolished stainless steel
- Field is magnetic
- Laser marking on request

	Label area (mm)	Dimensions W x D x H (mm)	Product code
Label holder 85/82/26	60 x 21	85 x 82 x 26	7504932

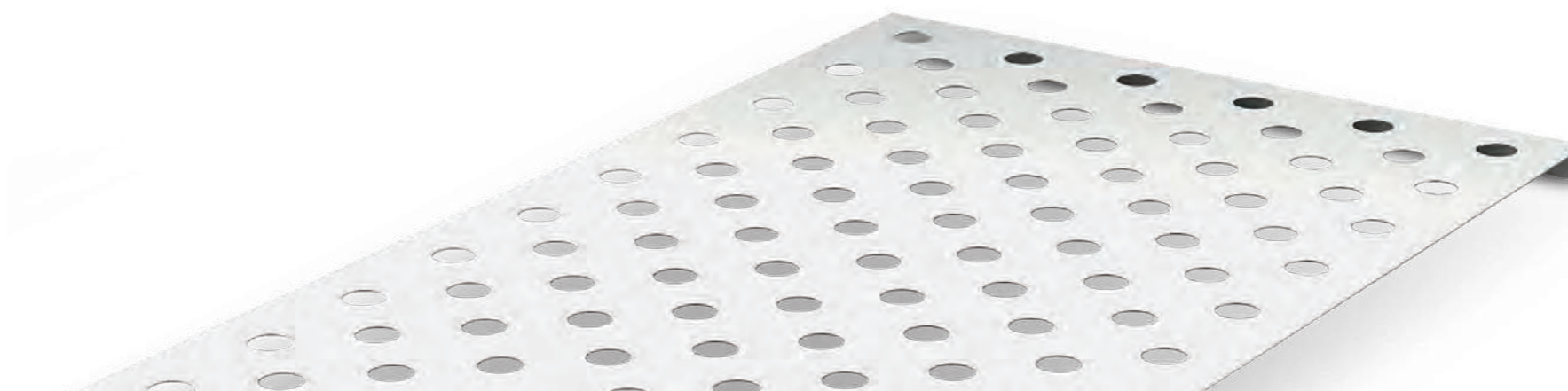

Norm 5 Medidul shelving unit



Side panel

- Stainless steel
- For uprights with 75 mm pitch

	For upright height (mm)	Product code
Stainless steel side panel 1800/600	1800	7505210
Stainless steel side panel 2000/600	2000	7505211



Rear panel

- Stainless steel

Width (mm)	For upright height 1800 mm	For upright height 2000 mm
	Product code	Product code
355		7505222
455		7505223
600	7505214	7505224
655	7505215	7505225
800	7505216	7505226
900	7505217	7505227
1000	7505218	7505228
1200	7505219	7505229
1400	7505220	7505230
1500	7505221	7505231



Base

- Stainless steel
- For Medidul shelf with side panels

	Product code
100 mm base for all lengths up to 2700 mm for Medidul shelf with side panels	7505233999
200 mm base for all lengths up to 2700 mm for Medidul shelf with side panels	7505234999



Flat top

- Stainless steel
- For Medidul shelf without side panels

	Product code
Stainless steel flat top, all lengths up to 2700 mm, for Medidul shelf without side panels	7505132999

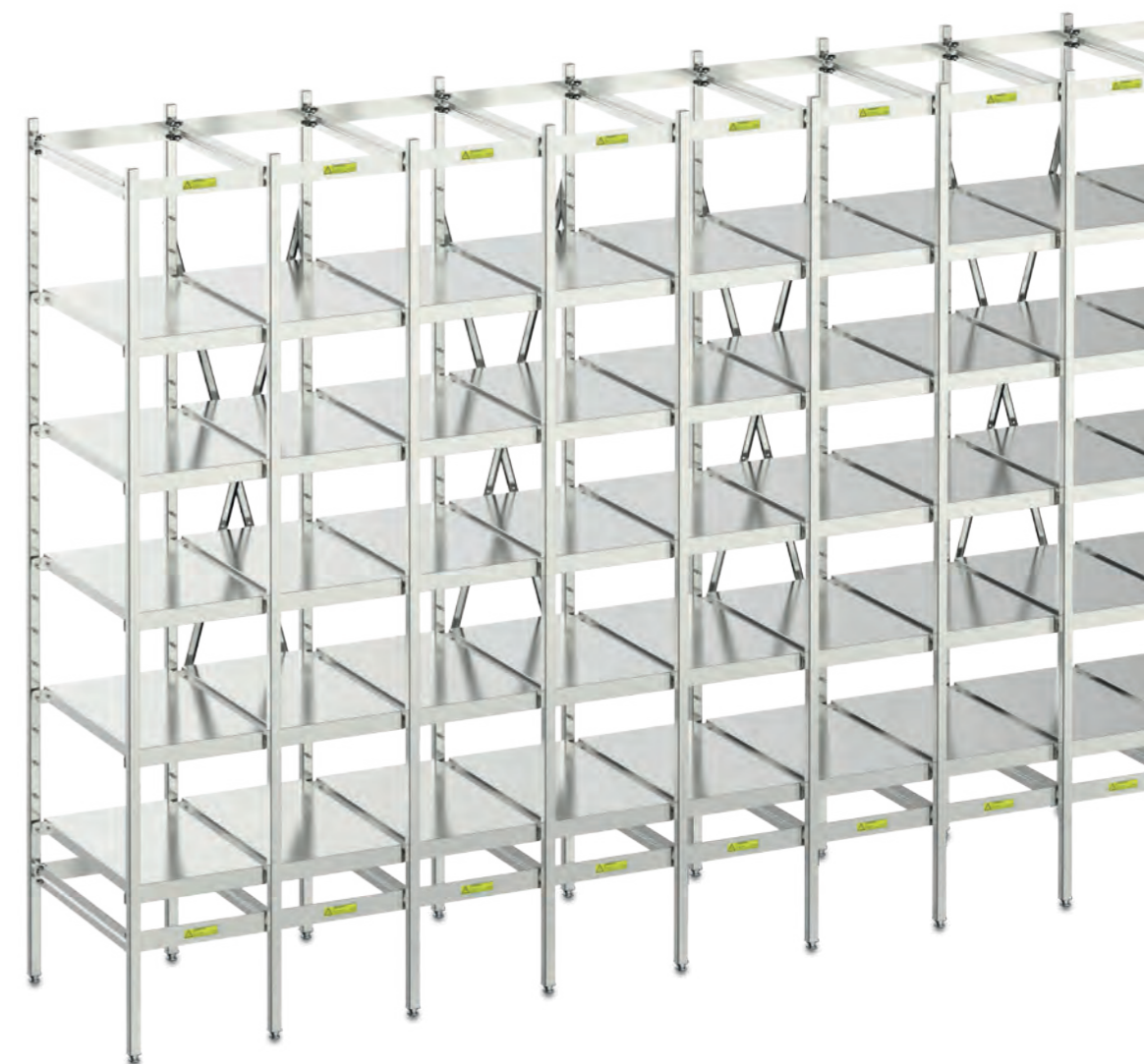

Norm 25 shelving unit

Rust-free, durable and extremely robust like the Norm 5 shelving unit, this shelf variant offers a special advantage: magnets stick to the special stainless steel alloy so that stored items can be easily, quickly and reliably labelled.



Norm 25 shelving unit with louvred shelves

- Stainless steel (special magnetic alloy)
- Section load: 600 kg

Maximum section load: 600 kg

Depth (mm)	Total width (mm)						
	500	1000	1200	1775	1975	2375	2775
600							



Norm 25 shelving with solid shelves

- Stainless steel (special magnetic alloy)
- Section load: 600 kg

Maximum section load: 600 kg

Depth (mm)	Total width (mm)						
	500	1000	1200	1775	1975	2375	2775
600							

SHELVING SYSTEMS
04



Norm 25 shelf load		
Shelf type	Width (mm)	Shelf load with equally distributed load (kg)
Louvred shelf	800-1000	150
	1200-1400	100
Solid shelf	800-1000	150
	1200	160
	1400	125

Versions with other sizes and dimensions can be found at www.hupfer.com

Norm 25 shelving unit



NORM 25 upright

- Stainless steel (special magnetic alloy)
- Pitch 150 mm

Maximum section load: 600 kg

Height (mm)	Maximum section load: 600 kg	
	For upright depth 500 mm	For upright depth 600 mm
	Product code	Product code
1800	0137000	0137001
2000	0137002	0137003



NORM 25 louvred shelf

- Stainless steel (special magnetic alloy)

Width (mm)	Maximum section load: 600 kg	
	For upright depth 500 mm	For upright depth 600 mm
	Product code	Product code
800	0137045	0137055
900	0137075	0137085
1000	0137105	0137115
1200	0137135	0137145
1400	0137165	0137175



NORM 25 solid shelf

- Stainless steel (special magnetic alloy)

Width (mm)	Maximum section load: 600 kg	
	For upright depth 500 mm	For upright depth 600 mm
	Product code	Product code
800	0137046	0137056
900	0137076	0137086
1000	0137106	0137116
1200	0137136	0137146
1400	0137166	0137176



NORM 25 cross brace

- Stainless steel
- Suitable for all shelf widths and uprights

Product code
0103072

RG-KV/N5 Medidul



Cross brace for back-to-back assembly

- Stainless steel
- Suitable for all shelf widths and uprights

Product code
0103082

RG-KV/N5 Medidul



Corner hook

- For louvred shelves and solid shelves
- For corner connections

Product code
0203126

RG-EVK N5/20/25

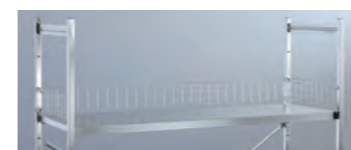

Push-through protection

- For rear attachment
- Electropolished stainless steel

Width (mm)	Product code
1000	0117414
1200	0117415
1500	0117417



Push-through protection

- For side attachment
- Electropolished stainless steel

Width (mm)	Product code
500	0117402
600	0117403

Norm 20 shelving unit

This shelving system, made of high-quality aluminium, combines low weight with a high loading capacity. Its tidiness and versatility are ideal wherever laundry and consumables are stored.



SHELVING SYSTEMS
04



Norm 20 shelving unit with louvred shelves

- Aluminium
- Number of shelves per section
- With cross brace

Maximum section load: 600 kg

Depth (mm)	Total width (mm)									
	1000	1200	1500	1775	1975	2375	2775	2975	3450	3650
300										
400										
500										
600										

Maximum section load: 1200 kg

Depth (mm)	Total width (mm)									
	1000	1200	1500	1775	1975	2375	2775	2975	3450	3650
400										
500										
600										



Norm 20 shelving unit with solid shelves

- Aluminium
- Number of shelves per section
- With cross brace

Maximum section load: 600 kg

Depth (mm)	Total width (mm)									
	1000	1200	1500	1775	1975	2375	2775	2975	3450	3650
300										
400										
500										
600										

Maximum section load: 1200 kg

Depth (mm)	Total width (mm)									
	1000	1200	1500	1775	1975	2375	2775	2975	3450	3650
400										
500										
600										

Versions with other sizes and dimensions can be found at www.hupfer.com

Norm 20 shelving unit

Norm 20 shelf load		
Shelf type	Width (mm)	Shelf load with equally distributed load (kg)
Louvred shelf	600-1000	200
	1200	160
	1400-1500	100
Solid shelf	600-1000	150
	1200-1500	100
Bottle shelf / box storage shelf	800-1000	100
	1000	100

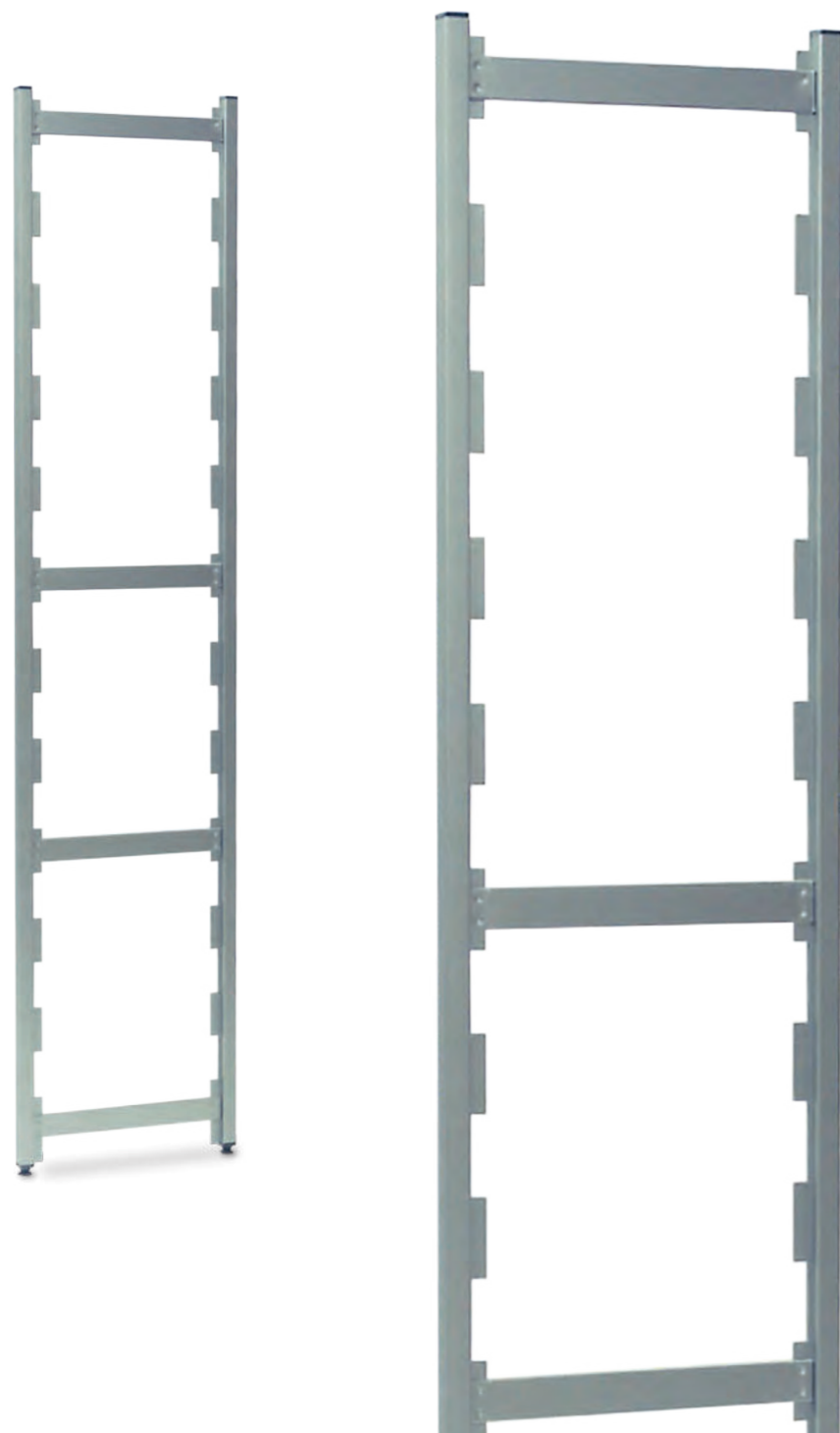

NORM 20 upright

- Aluminium
- Pitch 150 mm

Maximum section load: 600 kg

Height (mm)	For upright depth 300 mm	For upright depth 400 mm	For upright depth 500 mm	For upright depth 600 mm
	Product code	Product code	Product code	Product code
1200	0201007	0201017	0201037	0201047
1400	0201077	0201087	0201107	0201117
1600	0201147	0201157	0201177	0201187
1800	0201217	0201227	0201247	0201257
2000	0201287	0201297	0201317	0201327



NORM 20 upright

- Aluminium
- Pitch 150 mm

Maximum section load: 1200 kg

Height (mm)	For upright depth 400 mm	For upright depth 500 mm	For upright depth 600 mm
	Product code	Product code	Product code
1800	0201225	0201245	0201255
2000	0201295	0201315	0201325

Norm 20 shelving unit



Norm 20 louvred shelf

- Aluminium

Width (mm)	For upright depth 300 mm	For upright depth 400 mm	For upright depth 500 mm	For upright depth 600 mm
	Product code	Product code	Product code	Product code
600	0201532	0201542	0201562	0201572
800	0201602	0201612	0201632	0201642
900	0201672	0201682	0201702	0201712
1000	0201742	0201752	0201772	0201782
1200	0201812	0201822	0201842	0201852
1400	0201882	0201892	0201912	0201922
1500	0201952	0201962	0201982	0201992



NORM 20 solid shelf

- Aluminium

Width (mm)	For upright depth 300 mm	For upright depth 400 mm	For upright depth 500 mm	For upright depth 600 mm
	Product code	Product code	Product code	Product code
600	0202432	0202442	0202462	0202472
800	0202502	0202512	0202532	0202542
900	0202572	0202582	0202602	0202612
1000	0202642	0202652	0202672	0202682
1200	0202712	0202722	0202742	0202752
1400	0202782	0202792	0202812	0202822
1500	0202852	0202862	0202882	0202892



Norm 20 bottle shelf

- Polymer-coated steel
- Not for corner extension
- Silver grey

Width (mm)	Capacity for 0.75/1 litre bottles		For upright depth 500 mm
	Units per row	Units per row in combination	Product code
800	6	12	0204012
1000	8	15	0204022



Norm 20 box storage shelf

- Polymer-coated steel
- Upright and sideways storage
- Corner extension not possible

Width (mm)	Crate capacity (approximate)			For upright depth 500 mm
	Upright	Sideways	Shelf load with equally distributed load (kg)	Product code
1000	3	2	100	0204052



NORM 20 cross brace

- Aluminium
- Suitable for all shelf widths

Product code
0203062



Norm 20 cross brace • back-to-back

- Stainless steel
- Suitable for all shelf widths

Product code
0103082



Norm 20 shelving unit

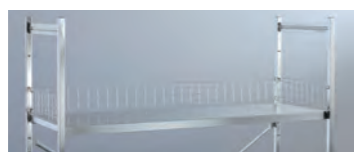

Push-through protection

- Electropolished stainless steel
- For rear attachment

For shelf width (mm)	Product code
1000	0117414
1200	0117415
1500	0117417

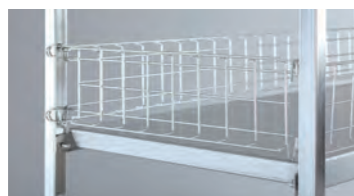

Push-through protection

- Electropolished stainless steel
- For side attachment

Depth (mm)	Product code
500	0117402
600	0117403

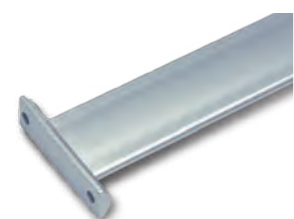

Bracing bar

- Aluminium
- As an alternative to the cross brace for loading the shelf from both sides
- With mounting accessories
- 4 long rails required per section

Width (mm)	Product code
800	0217022
900	0217023
1000	0217024
1200	0217025
1400	0217026
1500	0217027
1500	0217028



Corner hook

- For corner connections
- For louvred shelves and solid shelves

Product code
0203126



Double corner hook for hook rail

- For corner connections
- For louvred shelves and solid shelves

Product code
0211056



Shelf divider

- Stainless steel
- For enclosed systems

For shelf depth (mm)	Dimensions W x D x H (mm)	Product code
500	458 x 100 x 210	7504221
600	558 x 100 x 210	7504220

Norm 20 shelving unit



Shelf railing

- Stainless steel
- To stop items falling out of the front or back
- With polymer end caps

Width (mm)	Product code
600	0115242
800	0115243
900	0115244
1000	0115245
1200	0115246
1400	0115247
1500	0115248



Shelf railing holder

- Stainless steel
- Freely height-adjustable
- For use with shelf railing

Product code
0115252



Weight distribution plate

- Aluminium

Dimensions W x D x H (mm)	Product code
115 x 115 x 6	0203142



Hanging rail support

- Aluminium
- For attaching hook rails
- Also for securing stored items from the sides

For upright depth 300 mm	For upright depth 400 mm	For upright depth 500 mm	For upright depth 600 mm
Product code	Product code	Product code	Product code
0221862	0221872	0221892	0221902



Hook rail

- Aluminium
- For hanging between two uprights
- For attaching hooks
- Universal rail 45 x 10 mm

For shelf width (mm)	Product code
600	0203162
800	0203172
900	0203182
1000	0203192
1200	0203202
1400	0203212
1500	0203222



Ceiling or floor fixing attachment

- Stainless steel
- For additional securing of shelves
- Without fixing material

Product code
0103152

Norm 20 shelving unit



Wall mounting

- Stainless steel
- For upright

	Product code
	0116036
	0116037
	0116038



Wall fixing

- Stainless steel
- For uprights against walls with coving
- For 25 x 25 mm tube
- Without fixing material

Dimensions W x D x H (mm)	Product code
85 x 68 x 58	0116031

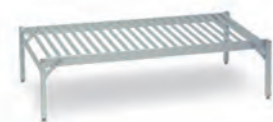

Wire shelf

- Aluminium
- For self-assembly

	Shelf load with equally distributed load (kg)	Dimensions W x D x H (mm)	Product code
RG-BR/N20 1000/500/300	200	1000 x 505 x 305	0203422
RG-BR/N20 1000/600/300	200	1000 x 505 x 305	0203442
RG-BR/N20 1200/500/300	160	1200 x 605 x 305	0203412
RG-BR/N20 1200/600/300	160	1200 x 605 x 305	0203432



Norm 12 shelving unit

The special mixture of aluminium and plastic makes this shelving system a versatile and attractive alternative for uses such as storing pharmaceuticals.



Norm 12 shelving unit with louvred polymer shelves

■ Aluminium/polymer

Maximum section load: 600 kg

Depth (mm)	Total width (mm)									
300	1000	1200	1500	1775	1975	2375	2775	2975	3450	3650
400										
500										
600										



Norm 12 shelving unit with solid polymer shelves

■ Aluminium/polymer

Maximum section load: 600 kg

Depth (mm)	Total width (mm)									
400	1000	1200	1500	1775	1975	2375	2775	2975	3450	3650
500										
600										

SHELVING SYSTEMS

04



Norm 12 shelf load		
Shelf type	Width (mm)	Shelf load with equally distributed load (kg)
Louvred and solid polymer shelves	600-1000	150
	1200	160
	1400-1500	100

Versions with other sizes and dimensions can be found at www.hupfer.com

Norm 12 shelving unit



NORM 12 upright

- Aluminium

Maximum section load: 600 kg

Height (mm)	For upright depth 400 mm	For upright depth 500 mm	For upright depth 600 mm
	Product code	Product code	Product code
1200	0201017	0201037	0201047
1400	0201087	0201107	0201117
1600	0201157	0201177	0201187
1800	0201227	0201247	0201257
2000	0201297	0201317	0201327



Norm 12 louvred polymer shelf

- Polymer

Width (mm)	For upright depth 400 mm	For upright depth 500 mm	For upright depth 600 mm
	Product code	Product code	Product code
600	0601549	0601569	0601579
800	0601619	0601639	0601649
900	0601689	0601709	0601719
1000	0601759	0601779	0601789
1200	0601829	0601849	0601859
1400	0601899	0601919	0601929
1500	0601969	0601989	0601999

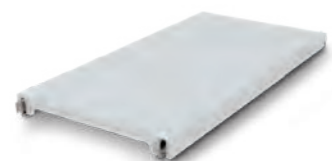

Norm 12 solid polymer shelf

- Polymer

Width (mm)	For upright depth 400 mm	For upright depth 500 mm	For upright depth 600 mm
	Product code	Product code	Product code
600	0602449	0602469	0602479
800	0602519	0602539	0602549
900	0602589	0602609	0602619
1000	0602659	0602679	0602689
1200	0602729	0602749	0602759
1400	0602799	0602819	0602829
1500	0602869	0602889	0602899



NORM 12 cross brace

- 1 unit for up to 3 sections
- Aluminium

	Product code
Aluminium Suitable for all shelf widths	0603062



Norm 12 cross brace • back-to-back

- 1 unit for up to 3 sections
- Stainless steel

	Product code
Stainless steel Suitable for all shelf widths	0103082

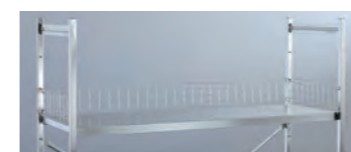

Push-through protection

- Electropolished stainless steel
- For rear attachment

Width (mm)	Product code
1000	0117414
1200	0117415
1500	0117417



Push-through protection

- Electropolished stainless steel
- For side attachment

Depth (mm)	Product code
500	0117402
600	0117403



Corner hook

- For louvred polymer shelves and solid polymer shelves
- For corner connections

	Product code
	0603139

Mobile shelving

Mobile shelving

Hupfer mobile shelving units combine two essential logistics functions: storage and transport. This means working material can be stored in large quantities but are always flexibly available where they are needed. Simpler work processes reduce the number of repacking operations and increase efficiency, economy and ergonomics.

With a wide selection of open and solid shelves, mobile shelving can be easily adapted to whatever items are stored on them. Smooth-running castors and practical total locks make them easy and safe to handle, even when carrying large quantities of stored items.



SHELVING SYSTEMS

04



Mobile shelving



Mobile shelving unit • height 900 mm

- In kit form
- For self-assembly
- Not including shelves
- Pitch: 150 mm

	Shelves (mm)	Dimensions W x D x H (mm)	Product code
RTW/Z 10-5/900	1000 x 500	1075 x 575 x 900	0121390
RTW/Z 10-6/900	1000 x 600	1075 x 675 x 900	0121391
RTW/Z 12-6/900	1200 x 600	1275 x 675 x 900	0121393
RTW/Z 14-5/900	1400 x 500	1475 x 575 x 900	0121394
RTW/Z 14-6/900	1400 x 600	1475 x 675 x 900	0121395



Mobile shelving unit • height 1200 mm

- In kit form
- For self-assembly
- Not including shelves
- Pitch: 150 mm

	Shelves (mm)	Dimensions W x D x H (mm)	Product code
RTW/Z 10-5/1200	1000 x 500	1075 x 575 x 1200	0121403
RTW/Z 10-6/1200	1000 x 600	1075 x 675 x 1200	0121404
RTW/Z 12-5/1200	1200 x 500	1275 x 575 x 1200	0121405
RTW/Z 12-6/1200	1200 x 600	1275 x 675 x 1200	0121406
RTW/Z 14-5/1200	1400 x 500	1475 x 575 x 1200	0121409
RTW/Z 14-6/1200	1400 x 600	1475 x 675 x 1200	0121410



Mobile shelving unit • height 1652 mm

- In kit form
- For self-assembly
- Not including shelves
- Pitch: 150 mm

	Shelves (mm)	Dimensions W x D x H (mm)	Product code
RTW/Z 10-5/1652	1000 x 500	1070 x 570 x 1652	0123092
RTW/Z 10-6/1652	1000 x 600	1070 x 670 x 1652	0123093
RTW/Z 12-5/1652	1200 x 500	1270 x 570 x 1652	0123094
RTW/Z 12-6/1652	1200 x 600	1270 x 670 x 1652	0123095
RTW/Z 14-5/1652	1400 x 500	1470 x 570 x 1652	0123096
RTW/Z 14-6/1652	1400 x 600	1470 x 670 x 1652	0123097



Norm 5 louvred shelf for RTW/Z

- Stainless steel
- Shelf load: 150 kg

	Width (mm)	Shelf load (kg)	RTW/Z 10/12/14-5	RTW/Z 10/12/14-6
			Product code	Product code
A-BR/N5 1000/500	1000	180	0101777	0101787
A-BR/N5 1200/500	1200	150	0101847	0101857
A-BR/N5 1400/500	1400	100	0101917	0101927



Norm 5 solid shelf for RTW/Z

- Stainless steel

	Width (mm)	Shelf load (kg)	RTW/Z 10/12/14-5	RTW/Z 10/12/14-6
			Product code	Product code
A-GS/N5 1000/500	1000	150	0102672	0102682
A-GS/N5 1200/500	1200	160	0102742	0102752
A-GS/N5 1400/500	1400	125	0102812	0102822



Norm 5 wired shelf for RTW/Z

- Stainless steel
- Wire spacing 25 mm

	Width (mm)	Shelf load (kg)	RTW/Z 10/12/14-5	RTW/Z 10/12/14-6
			Product code	Product code
A-DR/N5 1000/500	1000	180	0101772	0101782
A-DR/N5 1200/500	1200	150	0101842	0101852
A-DR/N5 1400/500	1400	100	0101912	0101922

Wall shelving

Wall shelving

Where there is not enough space for standing units, wall shelving from Hupfer offers practical storage space within easy reach so that working material is available wherever it is needed.

Both the length of the adjustable rails and the width, depth and type of shelves can be widely varied. This means the wall shelving can be adapted to requirements, without tools, for efficient work and flexibility.

Hupfer wall shelving is robust, can hold heavy loads and supports a wide variety of work processes without taking up additional space. Work material can be stored directly on the shelves or in wire baskets, always clearly arranged and in easy reach.

Carefully welded edges and sturdy surfaces guarantee easy cleaning and prevent damage to sensitive materials.

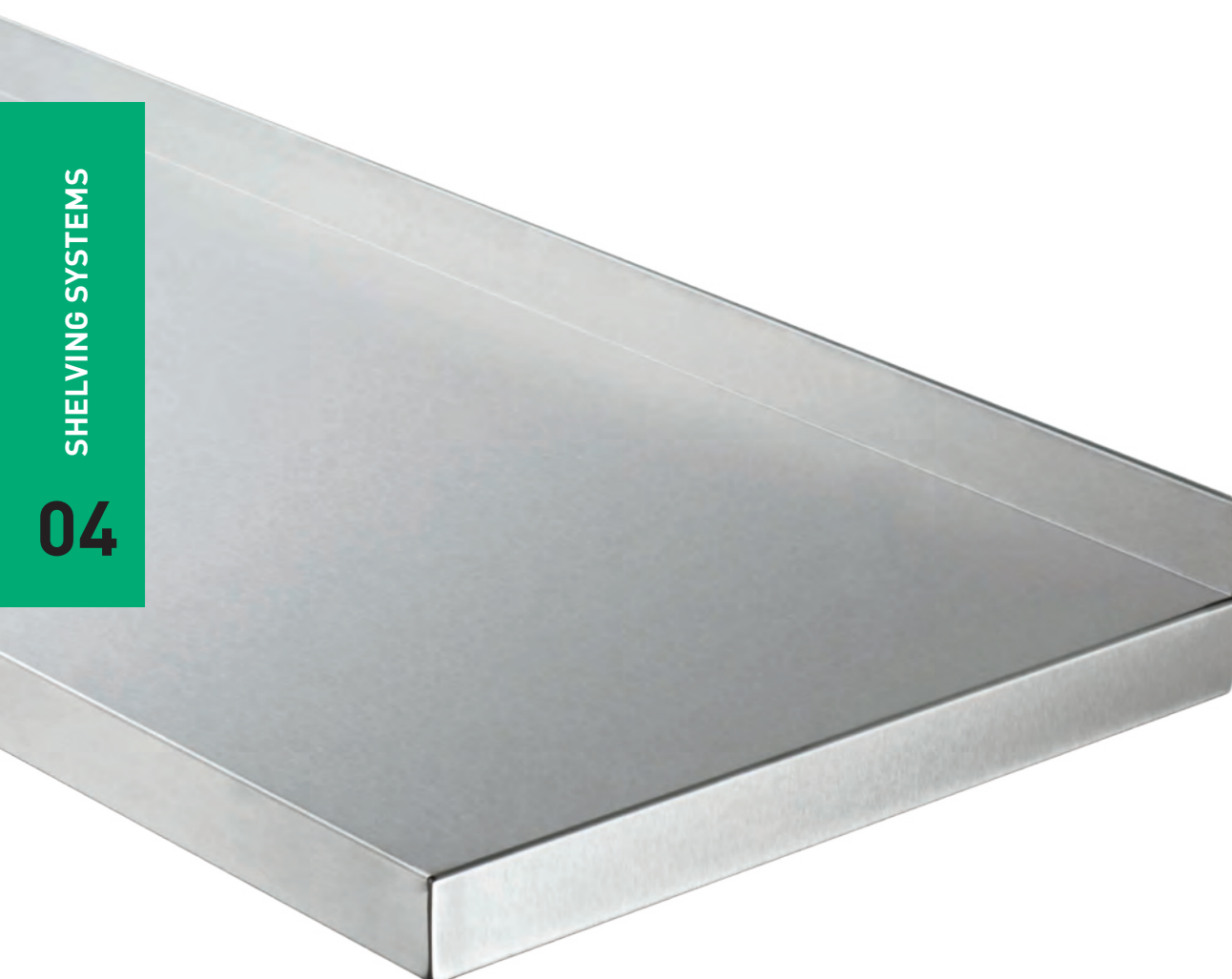

Wall shelving



Adjustable wall shelf rail

- For attaching brackets
- Depth: 25 mm
- Pitch: 75 mm
- 3 drill holes in the wall required

	Dimensions W x D x H (mm)	Product code
WB VeS 60/25/740	60 x 25 x 740	0163432
WB VeS 60/25/1200	60 x 25 x 1200	0163433



Wall shelf bracket

- For solid wall shelves
- For attaching to adjustable rails
- Stainless steel

	Shelf depth (mm)	Dimensions W x D x H (mm)	Product code
WB KON 300	300	42 x 294 x 144	0163434
WB KON 400	400	42 x 394 x 144	0163435



Shelf bracket for wall mounting

- For solid wall shelves
- For direct wall mounting
- Stainless steel

	Shelf depth (mm)	Dimensions W x D x H (mm)	Product code
WB KON-WB 300	300	42 x 280 x 144	0163436
WB KON-WB 400	400	42 x 380 x 144	0163437



Wall shelf bracket

- For Norm 5 and Norm 20 shelves
- For attaching to adjustable rails
- Electropolished stainless steel

	Shelf depth (mm)	Dimensions W x D x H (mm)	Product code
WB KON N5/20 300	300	42 x 299 x 199	0163461
WB KON N5/20 400	400	42 x 399 x 203	0163462

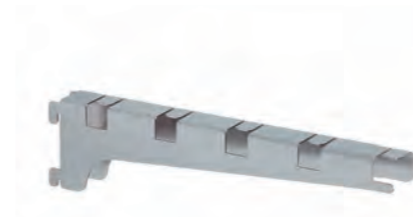

Wall shelf bracket

- For tubular shelves
- For attaching to adjustable rails
- Stainless steel

	Assembly	Tubular shelves	Dimensions W x D x H (mm)	Product code
WB KON 4RA 300 li	Left	4	42 x 314 x 103	0163463
WB KON 4RA 400 li	Left	5	42 x 414 x 103	0163466
WB KON 4RA 300 mi	Middle	4	42 x 312 x 103	0163464
WB KON 4RA 300 re	Right	4	42 x 314 x 103	0163465
WB KON 4RA 400 re	Right	5	42 x 414 x 103	0163468



Wall shelf

- With 40 mm upstand on the rear
- Stainless steel

	Dimensions W x D x H (mm)	Product code
WB A-GS 600/300	600 x 300 x 79	0163422
WB A-GS 800/300	800 x 300 x 79	0163423
WB A-GS 1000/300	1000 x 300 x 79	0163424
WB A-GS 1200/300	1200 x 300 x 79	0163425
WB A-GS 1400/300	1400 x 300 x 79	0163426
WB A-GS 600/400	600 x 400 x 79	0163427
WB A-GS 800/400	800 x 400 x 79	0163428
WB A-GS 1000/400	1000 x 400 x 79	0163429
WB A-GS 1200/400	1200 x 400 x 79	0163430
WB A-GS 1400/400	1400 x 400 x 79	0163431

Medical furnishings

Hupfer medical furnishings and fixtures are characterised by their high-quality workmanship, flexibility and extreme resilience in tough conditions. MediFurn® is a new generation of furnishings that sets new standards in terms of functionality, workmanship and design. The seamlessly welded products are easier to clean and hygiene can be more reliably maintained.





Added hygiene: bodies with HS, H1 and H2 quality

As well as products designed to the familiar HS hygiene standard, bodies with the optimised hygienic design types H1 and H2 as per DIN 18865-9 are now available.

The new models are characterised by a fully welded finish, with corners rounded to various spherical radii. The key benefit of seamless design is that there are no longer any gaps that secretions, blood, proteins or other liquids might penetrate.



HYGIENE SEVEE H2 For **hygiene level H2**, the bases and side panels of the bodies have a seamless welded design with a spherical radius of around 20 mm on the inside. This extra large radius is ideal for particularly thorough cleaning and significantly reduces the risk of germs. H2 bodies thus also offer maximum safety in places where maintaining hygiene is particularly challenging.

HYGIENE SEVEE H1 For **hygiene level H1**, the bases and side panels of the bodies are also seamlessly welded, with a smaller spherical radius of around 3 mm on the inside. H1 bodies are recommended for areas with low to moderate hygiene requirements.

HYGIENE SEVEE HS **Hygiene level HS** is still the standard that is most commonly used. Bodies manufactured in compliance with this standard still have seams between the base and side panels, making intensive cleaning more difficult. HS bodies are therefore only suitable for areas where hygiene is not critical.



The quickest fix: base with magnetic lock
The 100 mm base is secured to the floor frame with a magnetic catch and the joint can be sealed on site with silicone if necessary. This means the base can be quickly removed for maintenance.

Safe and strong: welded shelving bolts
All shelving bolts sit flush so that there are no hard-to-reach recesses, thus guaranteeing high cleaning standards.

Easy to clean: the hinges
The sturdy hinges are not fastened inside the door, but on top of the door to make cleaning easier.

Top-class protection: recessed handles
The handles in the drawers, runners and cabinet doors are all inside the contour of the worktop, helping to prevent collisions when passing.

Universal safety: sealing lips
The continuous seals on runners and doors stop liquids and dust from getting in.



A splash of colour: new surfaces

MediFurn® worktops, panels and doors are available in both tried-and-tested stainless steel (CNS 1.4301) as well as new Blackline design panels with decorative trims, in various colours. The robust material not only has highly resistant and durable surfaces, but also plenty of customisable design options thanks to its range of attractive colours. These provide a welcome contrast to the stern, sterile stainless steel and offer you complete freedom of design to incorporate your colour schemes and design concepts throughout your premises.





MediFurn® cleaning table systems

Cleaning tables are subject to particularly challenging hygiene conditions. To optimise hygienic safety, we equip the bodies of the MediFurn® cleaning table systems to meet hygiene levels H1 and H2 on request. The seamless design avoids dirt-prone recesses, so that cleaning is easier.

The **individual modules** (sink module, cabinet with doors, drawers, etc.) are available in various sizes and designs as required.

Our cleaning table systems are also available with optional **accessories**, such as air jets, spray attachments, spray guards and ultrasonic baths.



Our cleaning table systems are also available with optional **accessories**, such as air jets, spray attachments, spray guards and ultrasonic wells.



Wells are available in a range of designs and sizes, and sit seamlessly in the work surface.

Limitless options for all-round safety.

The modular design of MediFurn® furnishings means cleaning table systems can be created in any conceivable shape and size. They optimally combine high standards of functionality and ergonomic design. Precision manufacturing and smart solutions down to the finest detail guarantee easy cleaning and safety up to hygiene level H2.

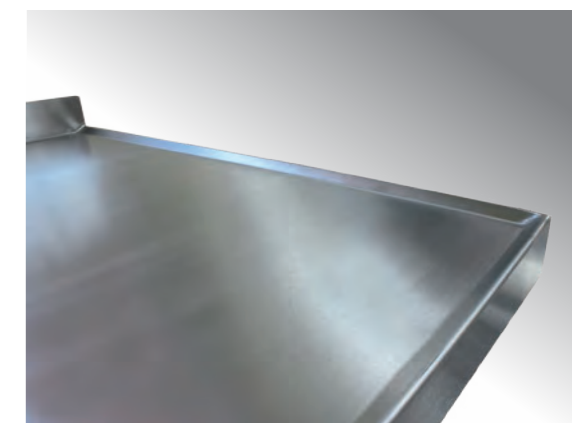
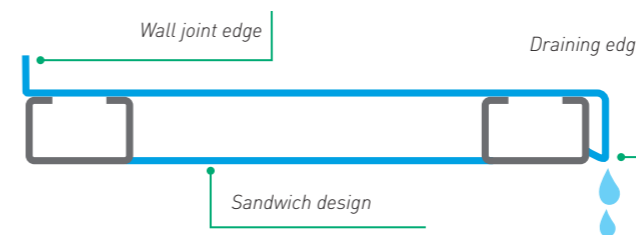

Effective beaded edging: Stops liquids from dripping off the worktop.

Beaded edging and draining edge

The beaded edging stops liquids dripping from the worktop while the draining edge reduces the risk of liquids penetrating the inside of the cabinet. Continuous sealing lips on the doors and runners provide additional protection.

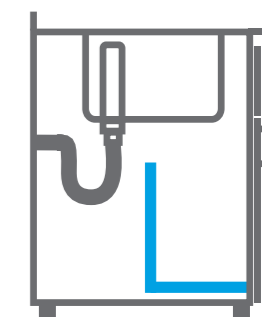
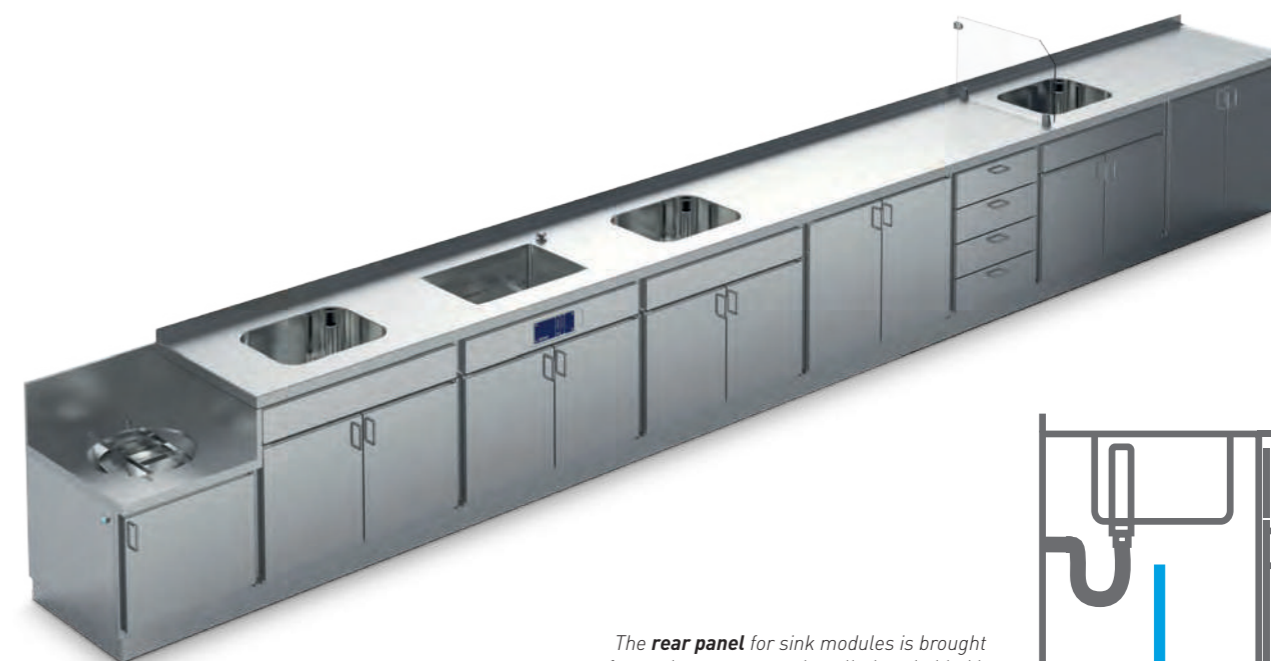

The **rear panel** for sink modules is brought forward to protect any installations behind it and **can be removed for inspection**.

MediFurn®



MediFurn® packing tables

Checking, sorting, cleaning, packaging – packing tables bring together a range of jobs at a single workstation. This means they have very high requirements for safe, functional and ergonomic technical equipment.

MediFurn® packing tables are made completely of premium quality stainless steel and are designed to be easily adapted to the needs of individual employees.

The tables offer maximum flexibility for connection to existing building services while height-adjustable tables can be set to the ideal working height at the touch of a button. All the technical components are arranged within easy reach.

On request, MediFurn® packing tables are also available as mobile versions with casters.

If additional working space is required, the tray pull-out is the optimum solution, and slides back under the work-top when not in use.

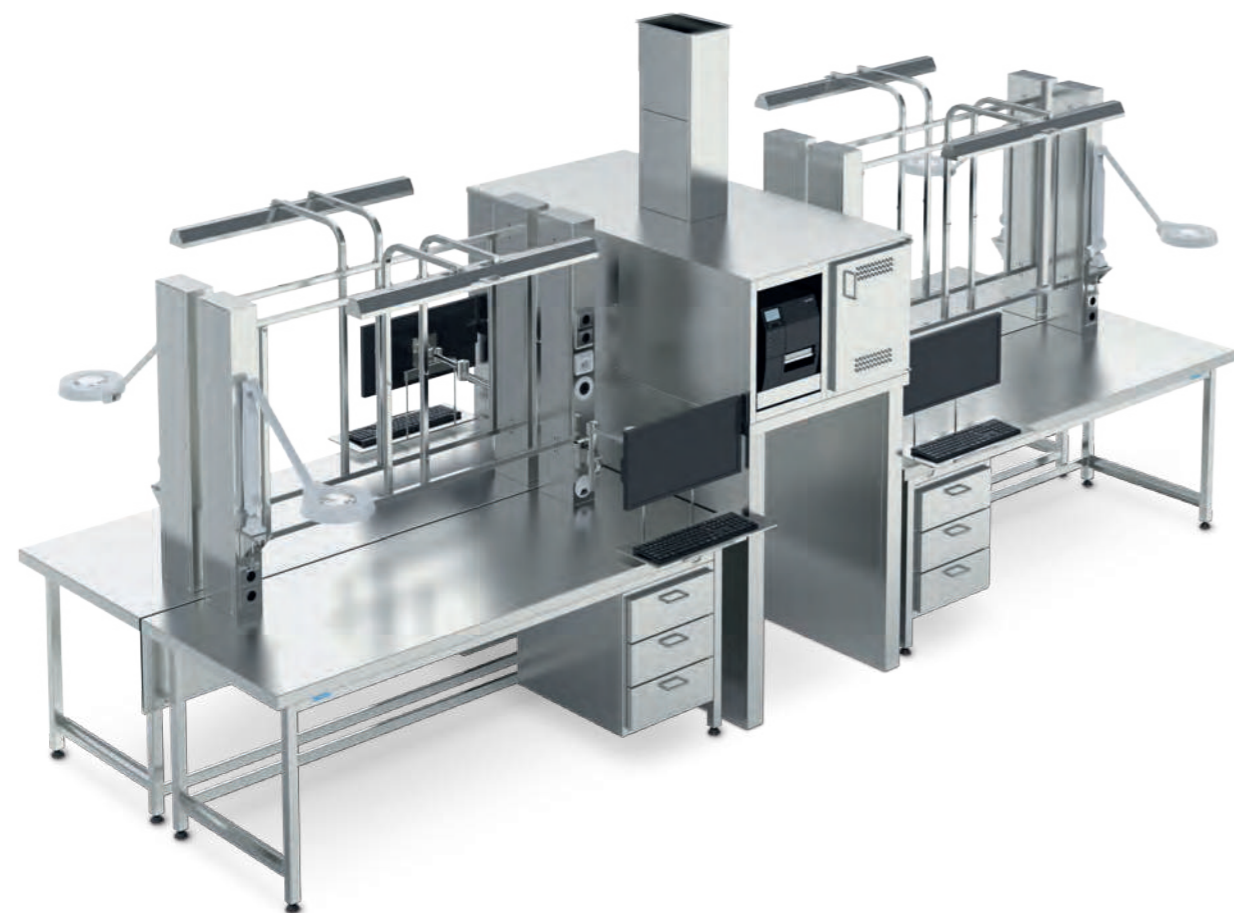

Energy-efficient LED technology and high-luminosity cold-light fluorescent tubes are available to illuminate the workplace.



The connection to the on-site compressed air, electricity and network outlets is made via the central utility column which optionally reaches to the ceiling. The connections can be accessed at any time via the inspection flap.



The working height can be precisely adjusted by up to 30 cm at the touch of a button on the digital display. The standard initial heights are 75 cm and 85 cm.



The PC cabinet with a fully extendable pull-out runner has wing doors with vents to ensure the circulation of air around computers and other equipment prone to heating up.



To avoid cable clutter, all connecting lines and cables can be routed along the trough over almost the entire width.



Drawer blocks, drawers for GN containers and fully extendable pull-out drawers are available for the base structure. Self-closing and wing doors are optionally available.

MediFurn®



MediFurn® – tall cabinets and wall cabinets

MediFurn® tall cabinets and wall cabinets provide space for protected storage and at the same time guarantee organisation, versatility and easy handling. They can be carefully tailored to a wide array of storage items and provide quick and secure access to material and tools.

They are designed to hold solid or wired shelves and can be alternatively equipped with polymer walls in StU or ISO format to store modular or sterile goods baskets.



Solid or wired shelves can be used to store a variety of items.



Internal polymer panels in ISO format are available as an option for storing modular and sterile goods baskets, making it even easier to handle items.



Claddings, inclined tops and flat tops ensure visually tidy connections all round to stop dust from collecting and to make the cabinets easier to clean.



Drawers in a range of sizes can be integrated as required.



The **pharmacy cabinet** is specially designed to provide safe storage for instruments. It can be easily pulled out to provide a perfect overview of everything inside. Holders are available for a wide range of instruments.



Depending on the application, the **cabinet modules** can be fitted with Medidul sections to hold **StU or ISO standard** sterile supplies basket and containers.

Medical furnishings



Packing and work tables

Hupfer packing and working tables help operational processes by providing space to work. The table frames are completely made of stainless steel. Many models come either with height-adjustable screw feet or in a mobile version with castors. Robust, easy-to-clean tabletops and intermediate shelves extend the range of uses even further.

Tops and bases in StU or ISO sizes can be individually equipped with baskets, shelves and many other accessories. This means that important work equipment is clearly sorted and within easy reach at all times. Utility columns are available for electricity and compressed air supplies.



Ergonomics at the touch of a button

The electrohydraulic height adjustment allows the working height to be adjusted to anywhere between 850 and 1150 mm. The powerful 230-volt electric motor is protected in the cabinet under the worktop so that installations are visible or get in the way.

The base can optionally be equipped with a solid shelf, a louvred shelf or a wired shelf from the Norm 5 shelving system.



Medical furnishings

Stationary packing tables

Sturdy, versatile and expandable packing tables can be used in many different departments. The electrohydraulic height adjustment makes them especially comfortable to use. It means the packing tables can be infinitely adjusted at the touch of a button to the optimum height for fatigue-free working.



Electrically height-adjustable packing table

- 50 mm anti-drip edge on all sides
- Worktop thickness: 1.5 mm
- 230 V electrical connection

	Maximum load (kg)	Weight (kg)	Dimensions W x D x H (mm)	Product code
PT-EH 1400/700/850-1150	250	48	1400 x 700 x 850 / 1150	7504885
PT-EH 1600/700/850-1150	217	52	1600 x 700 x 850 / 1150	7504843
PT-EH 1800/700/850-1150	245	56	1800 x 700 x 850 / 1150	7504851
PT-EH 2000/700/850-1150	150	60	2000 x 700 x 850 / 1150	7504842
PT-EH 2200/700/850-1150	200	71	2200 x 700 x 850 / 1150	7504852

Mobile packing tables



Small packing table

- Worktop thickness: 1.5 mm
- 4 swivel castors (2 with total brakes)

	Maximum load (kg)	Weight (kg)	Dimensions W x D x H (mm)	Product code
PT 850/750/900 F	150	23	850 x 750 x 902	7500216



Packing table

- Worktop thickness: 1.5 mm
- 4 swivel castors (2 with total brakes)

	Maximum load (kg)	Weight (kg)	Dimensions W x D x H (mm)	Product code
PT 1447/750/900 F	150	31	1447 x 750 x 902	7500184



Packing table

- Solid HPL worktop
- 4 swivel castors (2 with total brakes)

	Maximum load (kg)	Weight (kg)	Dimensions W x D x H (mm)	Product code
PT 1450/750/900 F 001	150	37	1447 x 750 x 900	7500461



Electrically height-adjustable packing table

- Worktop thickness: 1.5 mm
- 4 swivel castors (2 with total brakes)
- 230 V electrical connection

	Maximum load (kg)	Weight (kg)	Dimensions W x D x H (mm)	Product code
PT-EH 1400/700/850-1150 F	285	53	1400 x 700 x 850 / 1150	7504866
PT-EH 1600/700/850-1150 F	120	64	1600 x 700 x 850 / 1150	7504881
PT-EH 1800/700/850-1150 F	235	62	1800 x 700 x 850 / 1150	7504882
PT-EH 2000/700/850-1150 F	235	66	2000 x 700 x 850 / 1150	7504883

Medical furnishings

Stationary packing tables



Single hook rack for packing table

- With welded hooks
- Hook spacing: 350 mm
- Load per hook: 60 kg

	Hook sides	Dimensions W x D x H (mm)	Product code
HL/1s 555/40/1447	1	555 x 40 x 1447	7500217
HL/2s 555/55/1447	2	555 x 55 x 1447	7500431



Double hook rack for packing table

- With welded hooks
- Hook spacing: 350 mm
- Load per hook: 60 kg

	Hook sides	Dimensions W x D x H (mm)	Product code
HL/1s 1250/40/1447	1	1250 x 40 x 1447	7500185
HL/2s 1250/55/1447	2	1250 x 55 x 1447	7500430



NORM 5 solid shelf

- Stainless steel

	Width (mm)	Shelf load (kg)	For upright depth 400 mm Product code	For upright depth 600 mm Product code
A-GS/N5 800/400	800	150	0102512	0102542
A-GS/N5 1400/400	1400	125	0102792	0102822



NORM 5 wired shelf

- Stainless steel

	Width (mm)	Shelf load (kg)	For upright depth 400 mm Product code	For upright depth 600 mm Product code
A-DR/N5 800/400	800	180	0101612	0101642
A-DR/N5 1400/400	1400	150	0101892	0101922



Medical furnishings

Work tables

With their sturdy design and hard-wearing materials, Hupfer work tables show their special strengths even under the harshest conditions. Due to the sandwich design and stainless steel underside, the worktops are optimally vibration-free.



Open work table

- Stainless steel tabletop with sandwich design
- Underside enclosed in stainless steel
- Height-adjustable polymer feet

	Dimensions W x D x H (mm)	Product code
AT-O 1000/750/850	1000 x 750 x 850	7504583
AT-O 1200/750/850	1200 x 750 x 850	7504584
AT-O 1500/750/850	1500 x 750 x 850	7504585



Open work table with intermediate shelf

- Stainless steel tabletop with sandwich design
- Welded intermediate shelf
- Underside enclosed in stainless steel
- Height-adjustable polymer feet

	Dimensions W x D x H (mm)	Product code
AT-O/ZB 1000/750/850	1000 x 750 x 850	7504586
AT-O/ZB 1200/750/850	1200 x 750 x 850	7504587
AT-O/ZB 1500/750/850	1500 x 750 x 850	7504588



Medical furnishings

Operating theatre steps



With their sturdy construction and contoured non-slip surfaces, Hupfer operating theatre steps give a firm foothold for the ideal position in relation to the patient. The steps and frame are firmly bolted and can be dismantled for cleaning. The steps are of a uniform height with no overlap and are electrically conductive to ensure additional safety in the operating theatre. Hupfer operating theatre steps thus meet all the requirements of DIN EN 14183.

The **Hupfer hook trolley for operating theatre steps** is ideal for storage. Instead of the usual stacked storage, the steps are placed on separate brackets and can be easily removed as required. More information can be found on page 46.

**NEW:
COMPLIANT WITH
DIN EN 14183**



Single operating theatre step

- Bolted steps and frame
- Non-slip tread
- Anti-slip feet
- Electrically conductive

	Dimensions W x D x H (mm)	Product code
OP-A 600/350/130	600 x 350 x 130	7500294
OP-A 600/350/220	600 x 350 x 220	7500295
OP-A 600/350/300	600 x 350 x 300	7500296



Double operating theatre step

- Bolted steps and frame
- Non-slip tread
- Anti-slip feet
- Electrically conductive

	Dimensions W x D x H (mm)	Product code
OP-A 600/680/220-440	600 x 680 x 220-440	7500297

Medical furnishings

Pass-through chambers



The Hupfer pass-through chambers act as a barrier for the intermediate storage of goods between clean and unclean areas, as well as for delivering sterile supplies and disposing of contaminated material on Hupfer transport trolleys.

The stable, self-supporting and hygienic structure, made of high-quality stainless steel, consists of a body enclosed on all sides, with two double-walled wing doors each on the clean and the unclean sides. An electromagnetic door lock prevents the doors to the clean and unclean sides from being open at the same time. Red indicator lights indicate open doors on the opposite side, and there are green buttons to release the doors underneath, provided the doors on the opposite side are closed.



Pass-through chamber

■ Electrical interlock

	Transport trolley	Dimensions W x D x H (mm)	Product code
DRS 6StE 1150/900/1800	6 StU	1150 x 960 x 1800	7504604
DRS 9StE 1435/900/1800	9 StU	1436 x 960 x 1800	7504605



Medical furnishings

Wall-mounted hook rails

Hupfer wall-mounted hook rails are designed for quick and safe insertion, reorganisation and removal of storage baskets and attachments. The customised arrangement guarantees rapid handling of material and easy removal of consumables.

A large selection of attachments for wall-mounted hook rails can be found on pages 16 and 17 and from page 54, or at www.hupfer.com



Wall-mounted hook rail

- Welded hooks
- 30 kg maximum load per hook
- Threaded bolt for equipotential bonding
- Tube ends closed with polymer caps

	Number of hooks	Hook spacing mm	Rail length mm	Product code
WHSc 700-2/350	2	350	700	7500027
WHSc 1050-3/350	3	350	1050	7500028
WHSc 1400-4/350	4	350	1400	7500029
WHSc 1750-5/350	5	350	1750	7500030
WHSc 900-2/410	2	410	900	7500186
WHSc 1300-3/410	3	410	1300	7500187
WHSc 1600-4/410	4	410	1600	7500188
WHSc 900-4/215	4	215	900	7500189
WHSc 1300-6/215	6	215	1300	7500190
WHSc 1600-7/215	7	215	1600	7500031



Medical furnishings



Hygiene programme

Optimum hygiene is of the utmost importance in every clinic, hospital and sterilisation facility. However different the many types of task and work processes are, the Hupfer hygiene programme allows hand hygiene and disinfection everywhere to provide optimum safety for employees, patients and visitors.

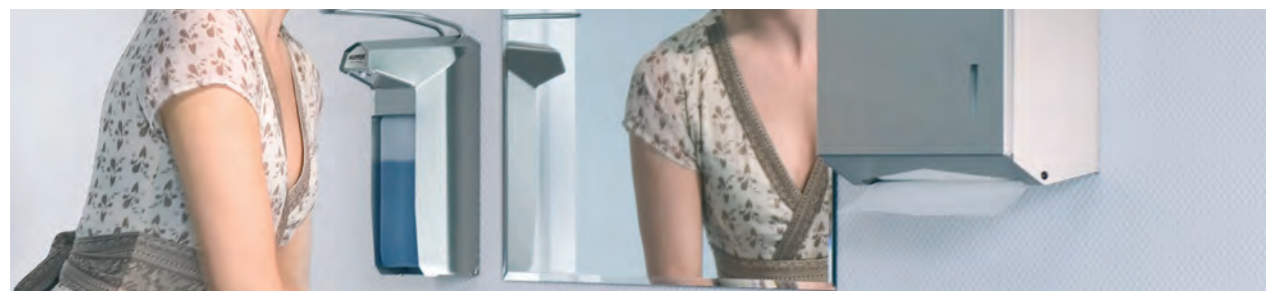

500 ml soap dispenser

- For interchangeable bottles
- Lockable

	Capacity (ml)	Dimensions W x D x H (mm)	Product code
Soap dispenser / K TC1-13	500	71 x 109 x 301	8600004



950 ml soap dispenser

- For interchangeable bottles
- Lockable

	Capacity (ml)	Dimensions W x D x H (mm)	Product code
Soap dispenser TC1-01	950	76 x 120 x 298	8600025



Soap/disinfectant dispenser

- Can be operated without hand contact
- Can be filled with any liquid soap, washing lotion or disinfectant

	Capacity (ml)	Dimensions W x D x H (mm)	Product code
SDMS Type I-1000	1000	93 x 197 x 302	8600129



Hand wash basin

- Knee-operated
- With rear panel and tap
- Not for pressureless water heaters with three lines

	Dimensions W x D x H (mm)	Product code
Hand wash basin EWB 400/310/560	400 x 310 x 560	8200342



Towel dispenser 300

- With vision panel
- Opening by bolt lock

	Capacity of folded paper towels	Dimensions W x D x H (mm)	Product code
Towel dispenser TC1-14	Approx. 300	300 x 126 x 308	8600006



Towel dispenser 500

- With vision panel
- Opening by bolt lock

	Capacity of folded paper towels	Dimensions W x D x H (mm)	Product code
Towel dispenser TC1-03	Approx. 500	298 x 120 x 298	8600022



Waste paper basket

- Free-standing or wall mounting

	Dimensions W x D x H (mm)	Product code
Waste paper basket TC1-11	340 x 265 x 425	8600029

Laundry and waste collectors

Hupfer laundry and waste collectors ensure safe, economical processes from sorting and treatment to the professional disposal of critical materials. The extensive product range allows solutions to be tailored to the specific situation and requirements.



Laundry and waste collectors

Laundry and waste collectors



Hupfer laundry and waste collectors make disposal tasks very easy to carry out. This is ensured by the stable construction, versions for various requirements and easy and safe manoeuvring on smooth-running castors.



Laundry and waste collector

- 3 compartments
- With rubber ring
- Stainless steel

	Dimensions W x D x H (mm)	Product code
SWA-3	1010 x 450 x 905	7501093



Laundry and waste collector

- With pedal and lid
- 1 compartment
- With rubber ring
- Stainless steel

	Dimensions W x D x H (mm)	Product code
SWAF-1	350 x 496 x 913	0163920



Laundry and waste collector

- 1 compartment
- With rubber ring
- Stainless steel

	Dimensions W x D x H (mm)	Product code
SWA-1	350 x 450 x 905	7501091



Laundry and waste collector

- With pedal and lid
- 2 compartments
- With rubber ring
- Stainless steel

	Dimensions W x D x H (mm)	Product code
SWAF-2	680 x 496 x 913	0163921



Laundry and waste collector

- 2 compartments
- With rubber ring
- Stainless steel

	Dimensions W x D x H (mm)	Product code
SWA-2	680 x 450 x 905	7501092



Laundry and waste collector

- With pedal and lid
- 3 compartments
- With rubber ring
- Stainless steel

	Dimensions W x D x H (mm)	Product code
SWAF-3	1010 x 496 x 913	0163922

Theatre laundry/waste collectors

Theatre laundry/waste collectors

Operating theatres place special demands on equipment and devices in clinics and hospitals. Hupfer theatre laundry/waste collectors are optimally tailored to this in their function and design, right up to their electrically conductive castors.



Theatre laundry/waste collectors

- 1 compartment
- With laundry bag holding frame
- Secure clamping of bag/nets
- Antistatic castors

	Dimensions W x D x H (mm)	Product code
OP-SWA-1 350/450/901	350 x 450 x 905	7500711



Theatre laundry/waste collectors

- 2 compartments
- With laundry bag holding frame
- Secure clamping of bag/nets
- Antistatic castors

	Dimensions W x D x H (mm)	Product code
OP-SWA-2 680/450/901	680 x 450 x 905	7500712

Accessories for theatre laundry/waste collectors

Lid for collector

- With pedal
- Polystyrene
- White



	Model	Dimensions W x D x H (mm)	Product code
Lid 290x400x25 mm	Without hinge	290 x 400 x 25	7501008
Lid 290x421x25 mm	With hinge	290 x 421 x 25	7501009

Lid for collector without pedal

- Without pedal
- Polystyrene
- White



	Model	Dimensions W x D x H (mm)	Product code
Lid 290x400x60 mm	Without hinge	290 x 400 x 60	7500261
With hinge	Collector with pedal	290 x 400 x 60	7501679

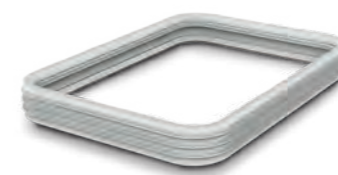

Rubber ring

	Dimensions W x H (mm)	Product code
Rubber ring 374/40	374 x 40	7500260



Highly recommended: the knowledge and experience of our experts

We are always happy to help

Presented by

Our general terms and conditions at www.hupfer.com/de/avb apply. Prices do not include statutory VAT and shipping costs¹. The latest prices at www.hupfer.com apply

¹Handling and standard freight charge

Germany (mainland, excluding islands): €35 for a net goods value up to €750;

plus transport insurance amounting to 0.5% of the merchandise net value

Standard freight charge, international: €70 for a net goods value up to €1500;

plus transport insurance amounting to 0.5% of the merchandise net value

The standard freight charge applies to shipping of general cargo by overland transport.

Hupfer

Dieselstraße 20 · 48653 Coesfeld

P.O. Box 14 63 · 48634 Coesfeld

Tel.: +49 2541 805-0

Fax: +49 2541 805-111

info@hupfer.com · www.hupfer.com

RWS 03/20. Hupfer 2020. All data/dimensions are approximate. Subject to technical changes. Not to be reproduced in any form, whether in part or in full, without prior permission. All images are examples, without decoration, and may include special equipment. Concept and layout: RWS Group Deutschland GmbH, Berlin.

HUPFER
we make work flow