

te4 - 4.5x3

roof + valance

### graphic dimensions

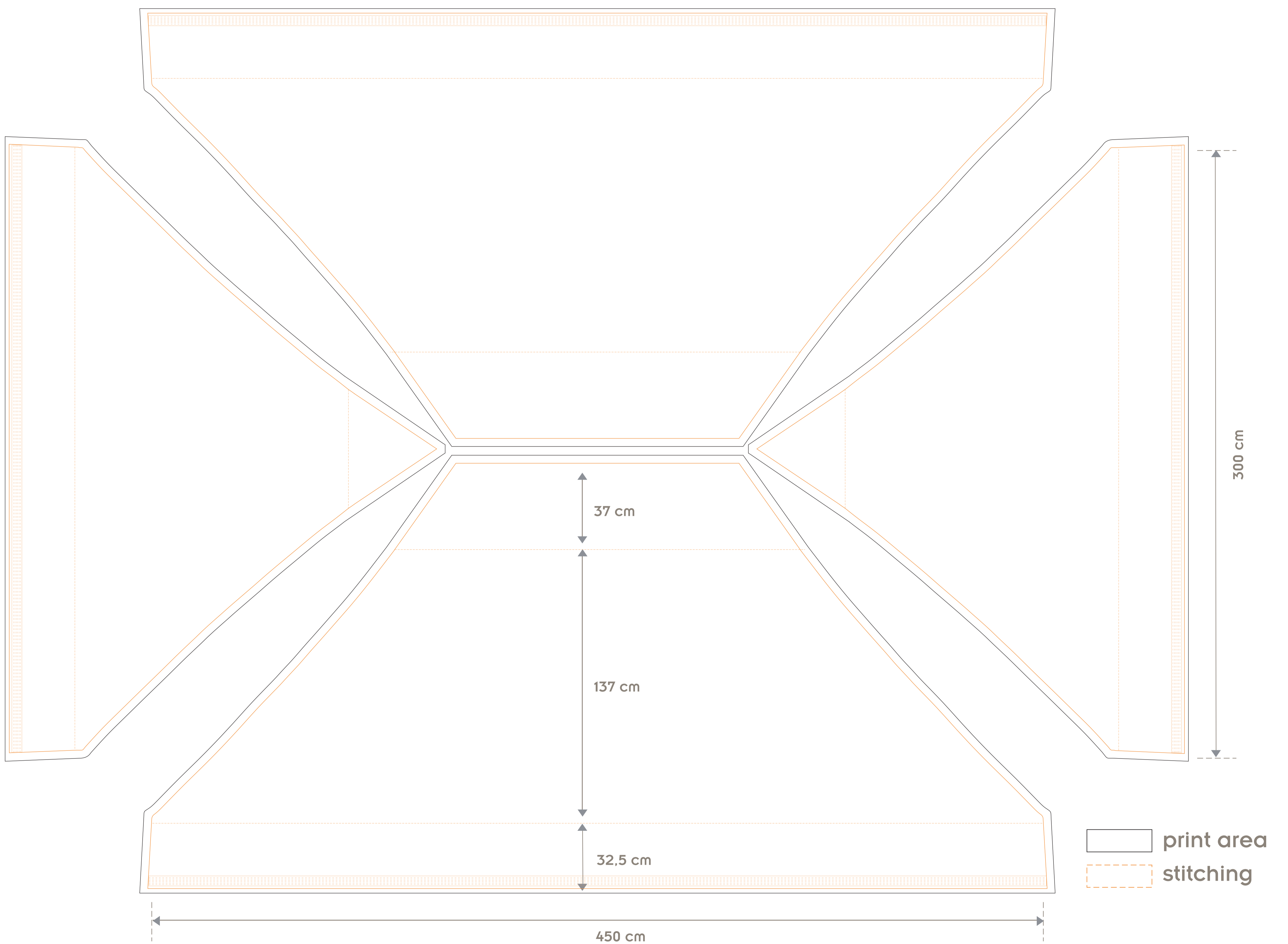

template 1:10

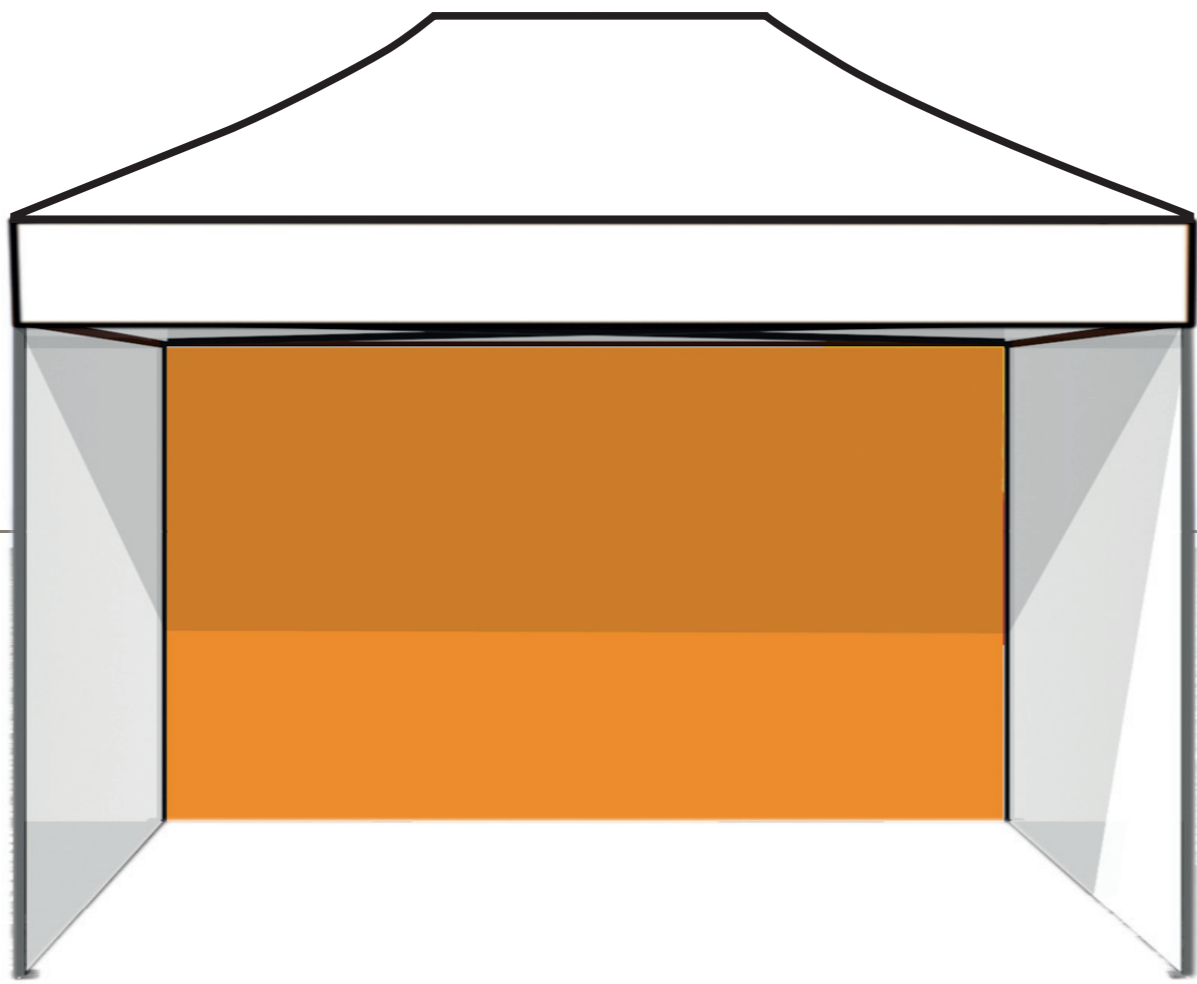



te4

side wall 4.5 m

### graphic dimensions

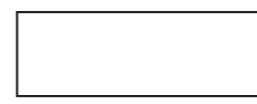

template 1:10

 print area  
 stitching

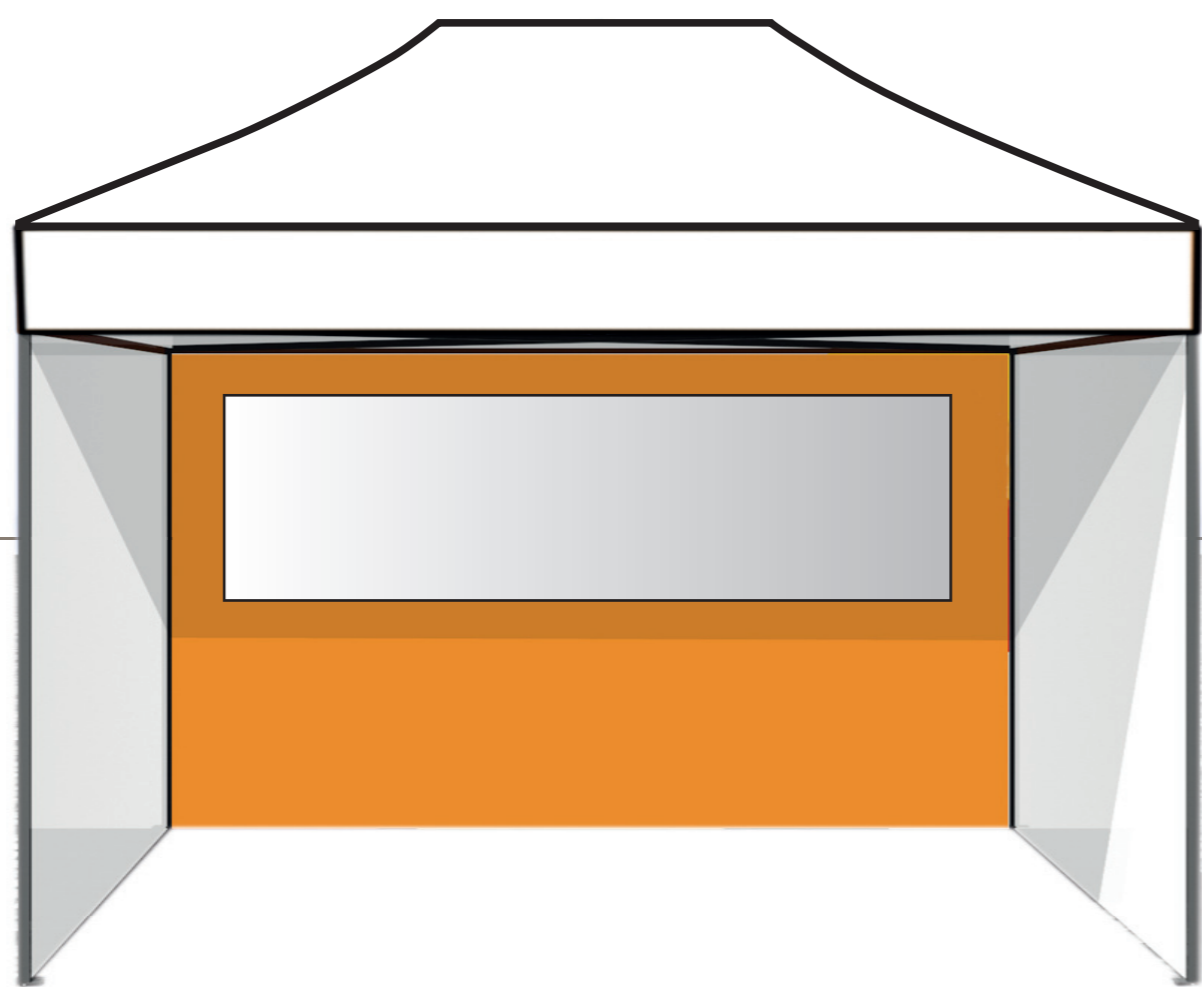

te4

window for side wall 4.5 m

graphic dimensions

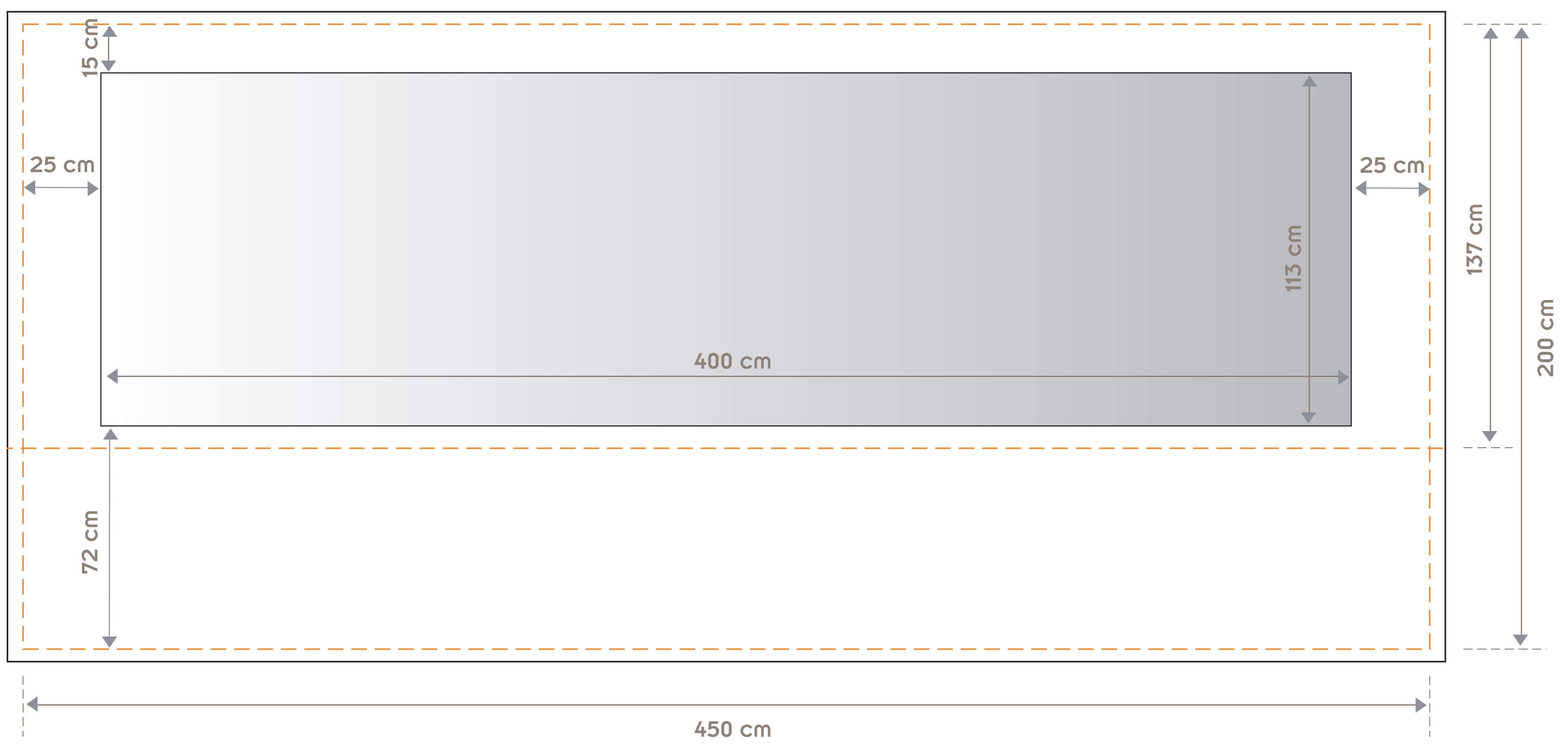

template 1:10

- print area
- stitching

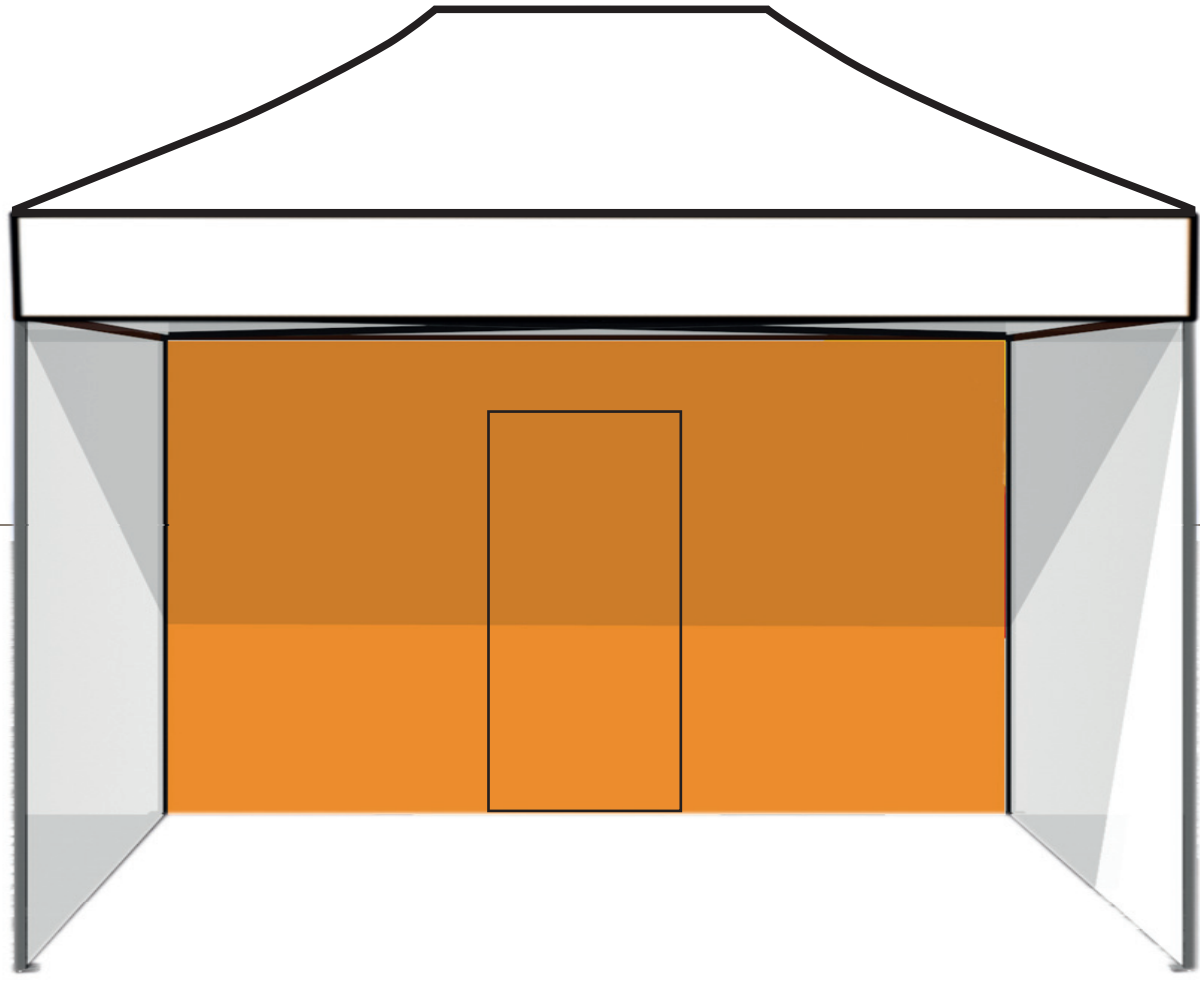



te4

door for side wall 4.5 m

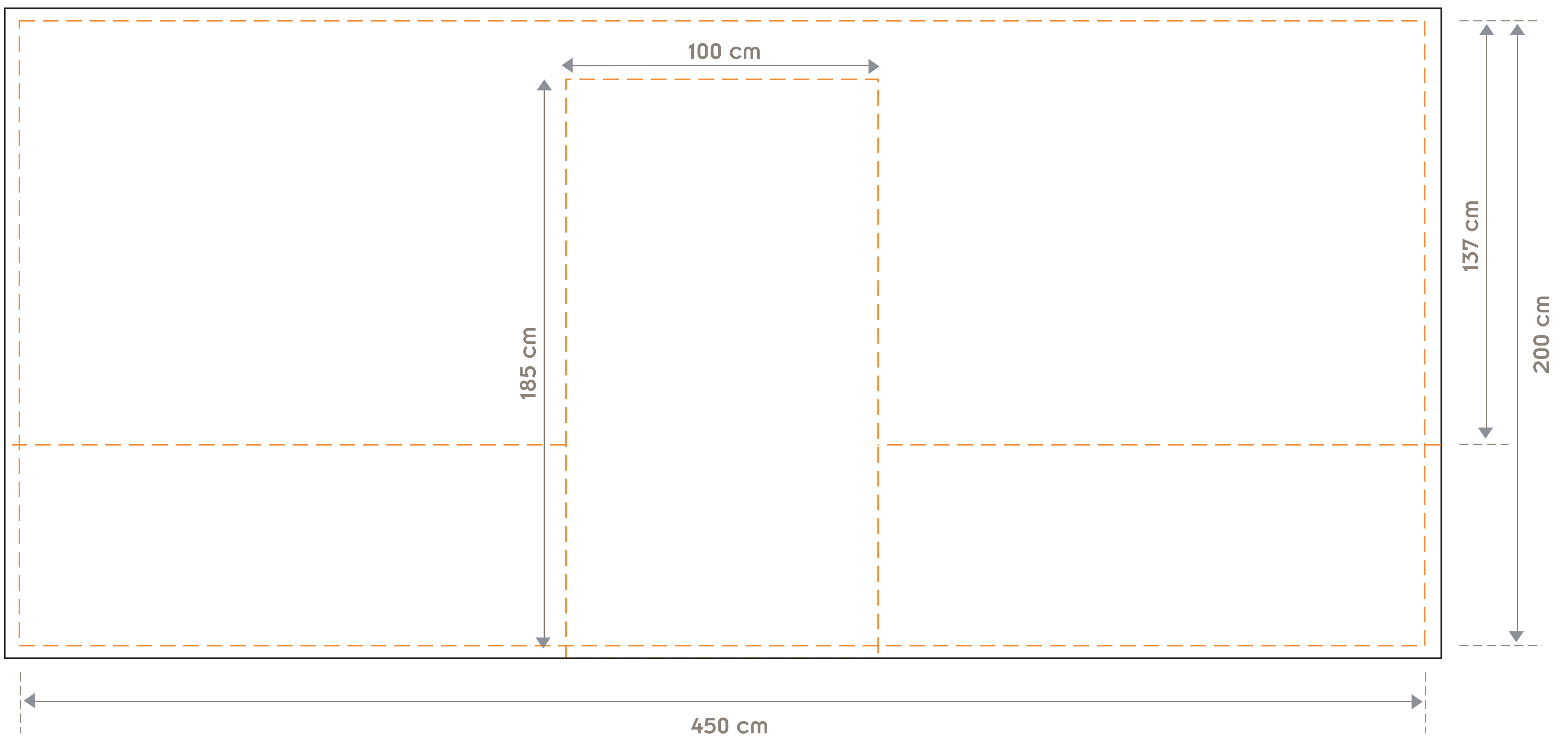
### graphic dimensions

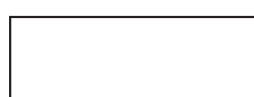

template 1:10

-  print area
-  stitching

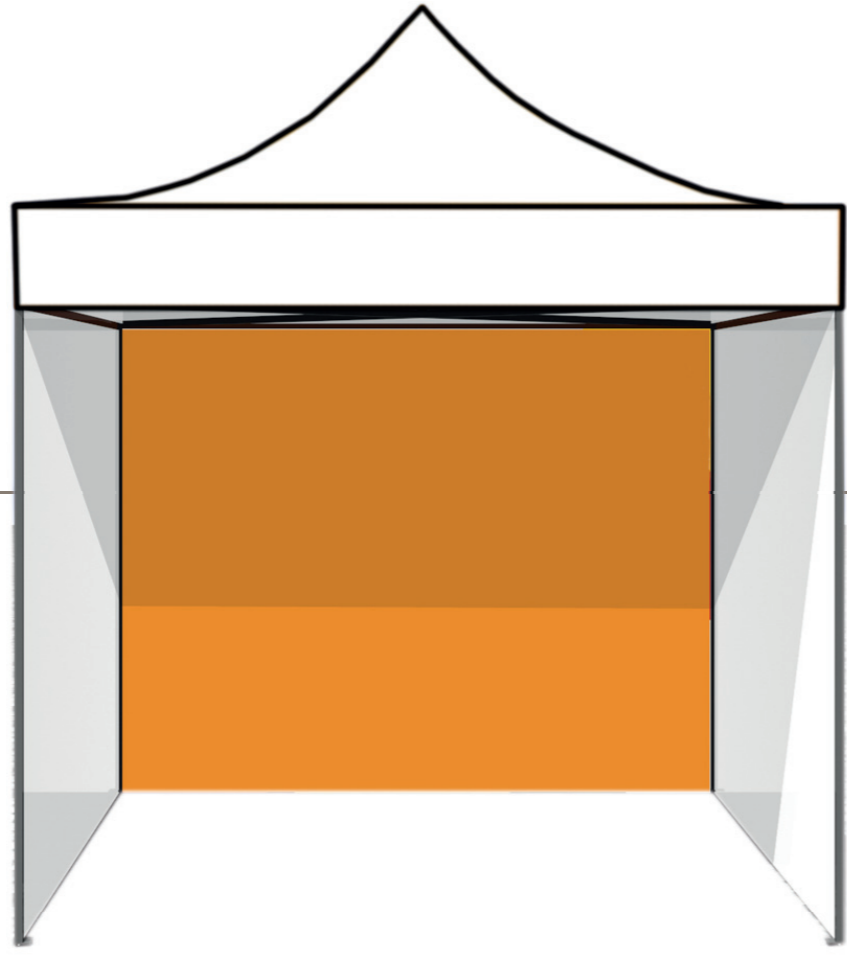



te4

side wall 3 m

### graphic dimensions

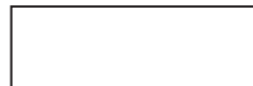

template 1:10

-  print area
-  stitching

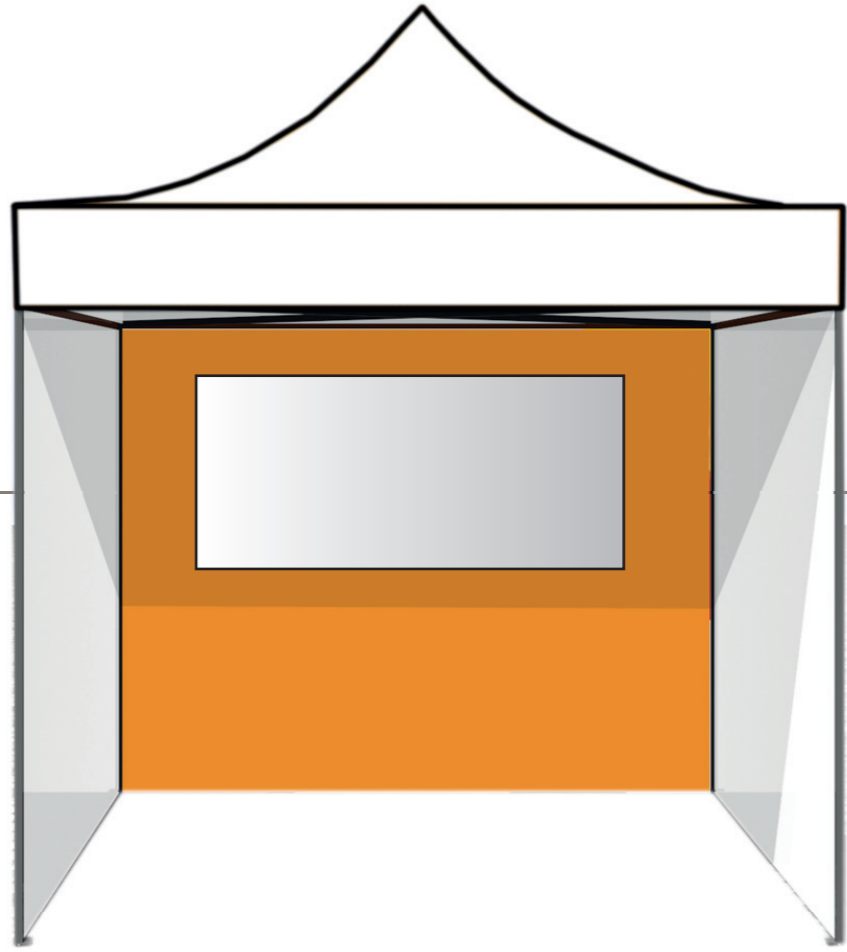



te4

window for side wall 3 m

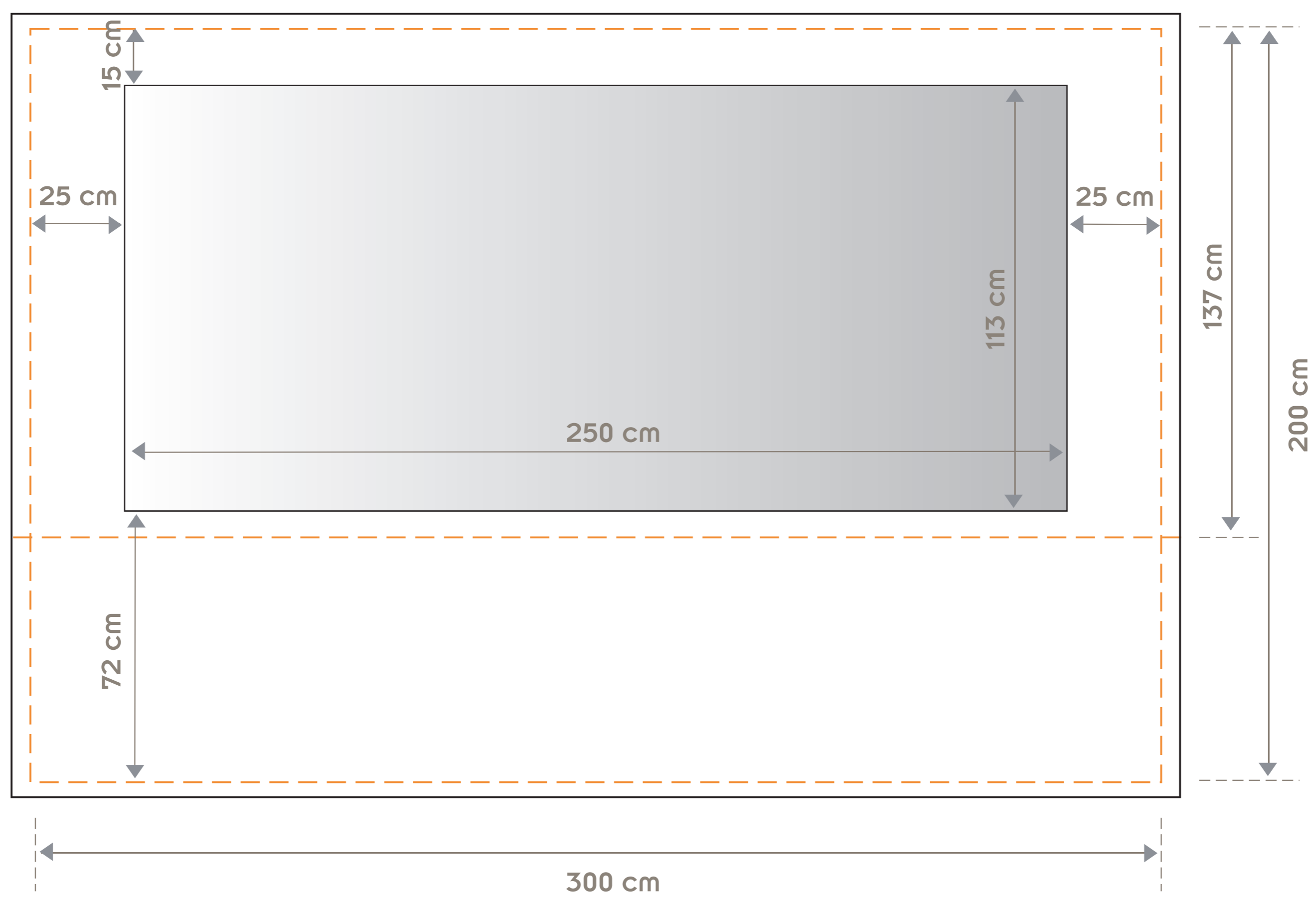
### graphic dimensions



template 1:10

-  print area
-  stitching

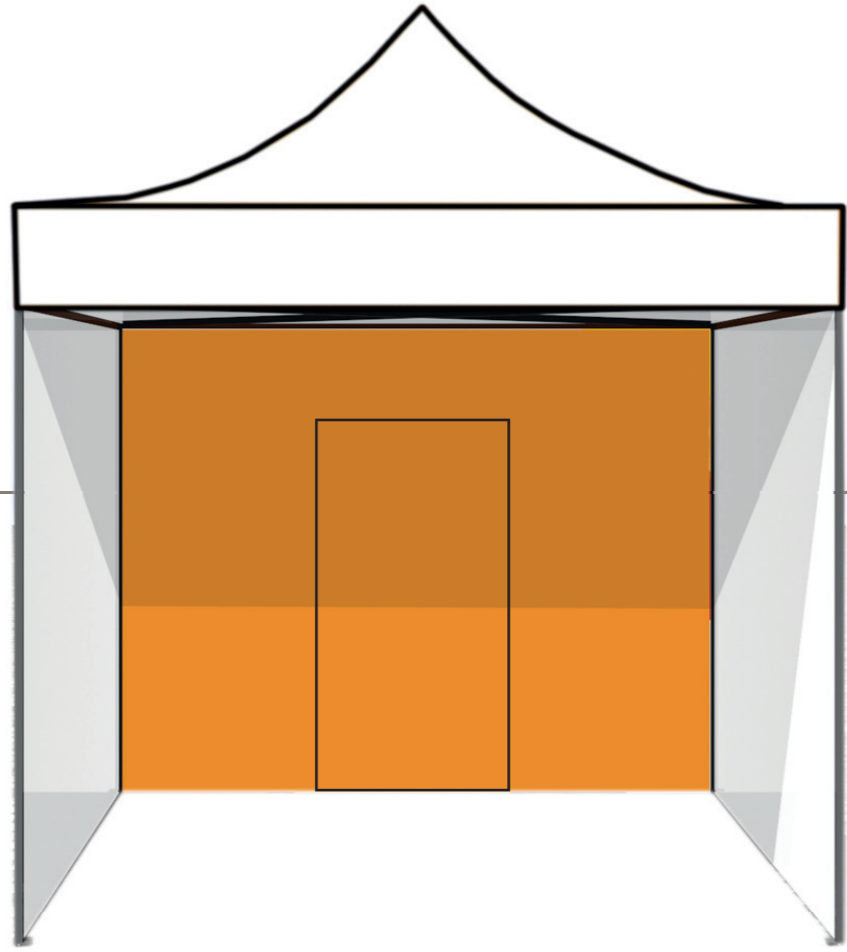



te4

door for side wall 3 m

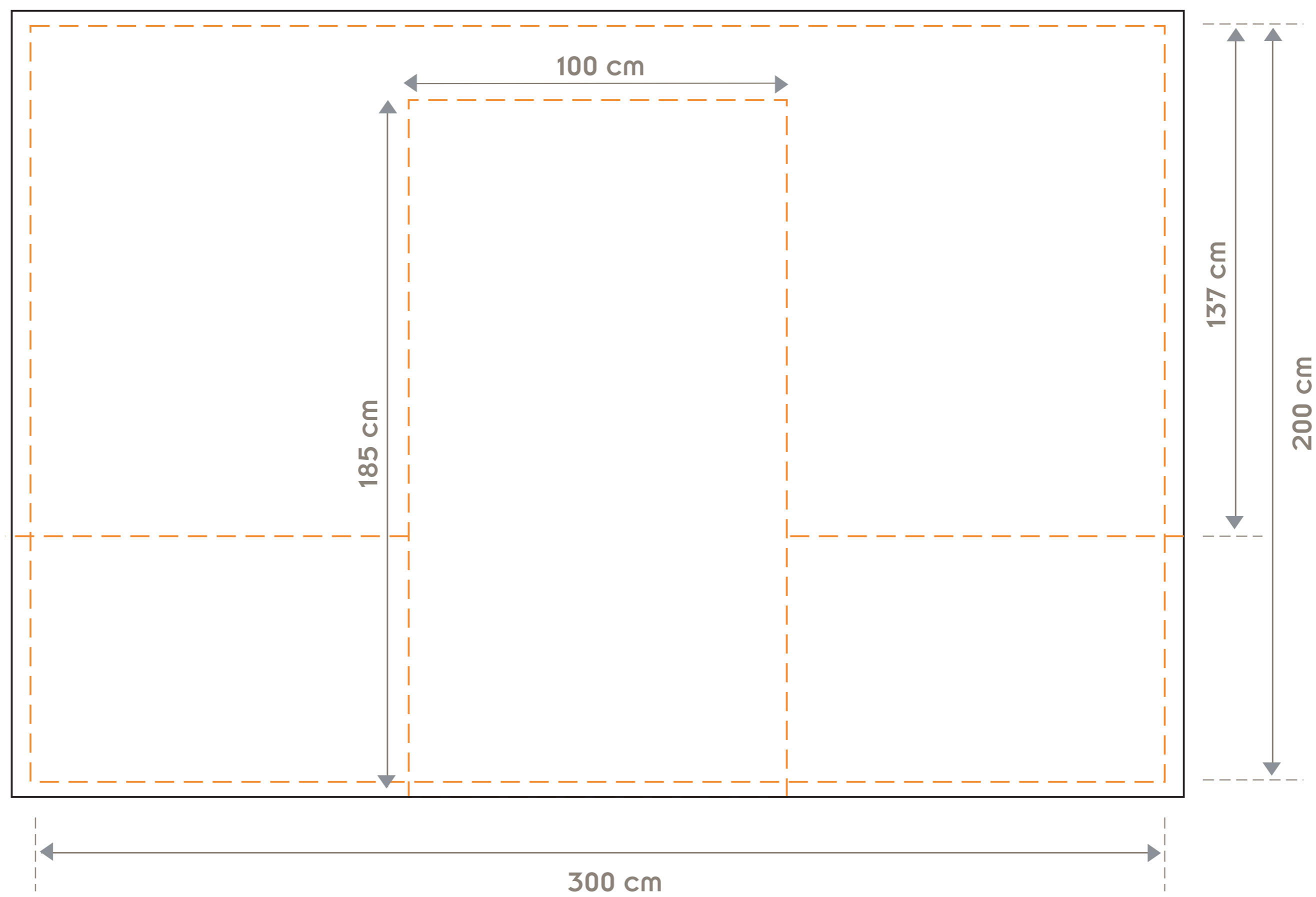
### graphic dimensions

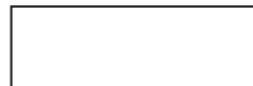

template 1:10

-  print area
-  stitching