



# All-In-One-Solution hd AudioBar 55

Audiophile collaboration solution in hd



## hd AudioBar 55

### Audiophile collaboration solution in hd

The hd AudioBar is an audiophile all-in-one sound system for conference rooms, training rooms, and multi-media applications with configurable audio matrix mixer with digital



mixing console features and presenter functionality. Thanks to the integrated LinearPhase-FIR filter technology, a linear transmission behavior with excellent speech intelligibility even in video conferences or presentations is enabled. FIR filter technology, previously used only in a few and the very best high-performance sound systems, enables frequency and phase-independent sound optimization and is extra ordinary to be integrated to a soundbar. Feedback and a falsified sound with missing consonants and clarity are a thing of the past. The stereo-arranged dual-centric mid / high loudspeaker achieves a broad horizontal radiation and allows breathtaking effect reproduction and depth gradation of the sound image. The integrated subwoofer array delivers a crisp, round bass without booming. The input stage consists of a stereo line-in with auto-detect function for TV or media sound and two microphone line-in for the connection of wireless microphones, headsets, clip-on microphones or any line signals. A volume control for both microphone channels is located on the rear panel, which is recessed. Four sound presets and four microphone presets, suitable for the most common microphone types and models, can be recalled by using the





# hd AudioBar 55 Datasheet



preset buttons on the recessed connection panel. A dynamic processor with expander, compressor and gate function for the microphone channels and a freely configurable EQ section for room and microphone equalization allows the best adjustment of the player device without additional hardware. BYOD prepared thanks to integrated Bluetooth 5.0. For the audio-technical equipment of HuddleRooms, media steles, conference rooms, museums, educational institutions or hotel suites, the state-of-the-art, reliable and easy-to-use all-in-one solution hd AudioBar can be used cost-effectively without compromising at any point and external DSPs and matrix systems become superfluous. With the help of mounting brackets, the hd AudioBar can be easily attached to VESA brackets on the screen. Alternatively, all common wall brackets can be attached to the continuous T-slot on the back. Thanks to flexible manufacturing processes, the hd AudioBar has been adaptable to the screen dimensions and environment for years – without a long delivery time.

A recessed connection panel with three 3.5 mm jack input sockets with auto-detect function, 4-pin Power-Din power socket for external 24V power supply, BT pairing button and two preset buttons are located on the back of the housing.



# hd AudioBar 55 Datasheet

## Features

- complete Plug & Play audio solution with digital mixer functions
- 2x microphone inputs + media sound
- 4 microphone presets + 4 sound presets
- BYOD compatible via Bluetooth 5.0

## DSP & electronics features

- 4-channel Class-D amplifier with 300 W RMS
- 4 + 2In / 4Out high-end hd ProDSP with > 50 MIPS
- LinearPhase FIR filter
- Wireless-Audio optional

## Acoustic & mechanical features

- L / R dual-concentric chassis
- integrated subwoofer array for extended frequency response from 45 Hz
- for 65 "screen, custom-made production screen dimensions without long delivery times
- elegant high quality aluminum housing with recessed connections

## Application

Media steles, educational institutions, huddle rooms, museums, conference rooms, training rooms, hotels

<b>Model</b>	<b>hd AudioBar 55</b>
<b>Order number</b>	402015-55
<b>Design</b>	active 2.1 Multi-Media-System
<b>Transducers</b>	L/R: 2x 3,5" + 1" DualConcentric Subwoofer: 3x 3,5" long-stroke-woofers + 2x 3,5" super-long-stroke passive radiators
<b>Coverage (hor x ver)</b>	80° x 80°
<b>Frequency range (-6 dB)</b>	45 Hz - 22 kHz
<b>SPLmax @ 10% THD</b>	111 dB
<b>Amplifier power</b>	300 W RMS
<b>Digital Signal Processor</b>	hd ProDSP 4+2In 4Out - FIR-/IIR-Filter, RoomEQ, MicEQ, Compressor, Gate, Expander, Matrix, 4 Sound-Presets, 4 Mic-Presets, Remote control
<b>Connections</b>	1x Stereo 3,5 mm jack line in, 2x Mono 3,5 mm jack Mic in, 1x mini USB, 1x 4-pin DIN power socket - 24V PSU, Wireless-Audio optional
<b>Enclosure</b>	powder-coated aluminum housing black, grille with acoustic foam, recessed connection panel, volume control, 2x preset button, pairing button
<b>Optional accessories</b>	RAL-Color (Art. 1070), various wall brackets, special length (Art. 40713)
<b>Weight</b>	7 kg
<b>Dimensions (W x H x D)</b>	108 x 1235 x 104 mm

# hd AudioBar 55 Datasheet

## Dimensions [mm]

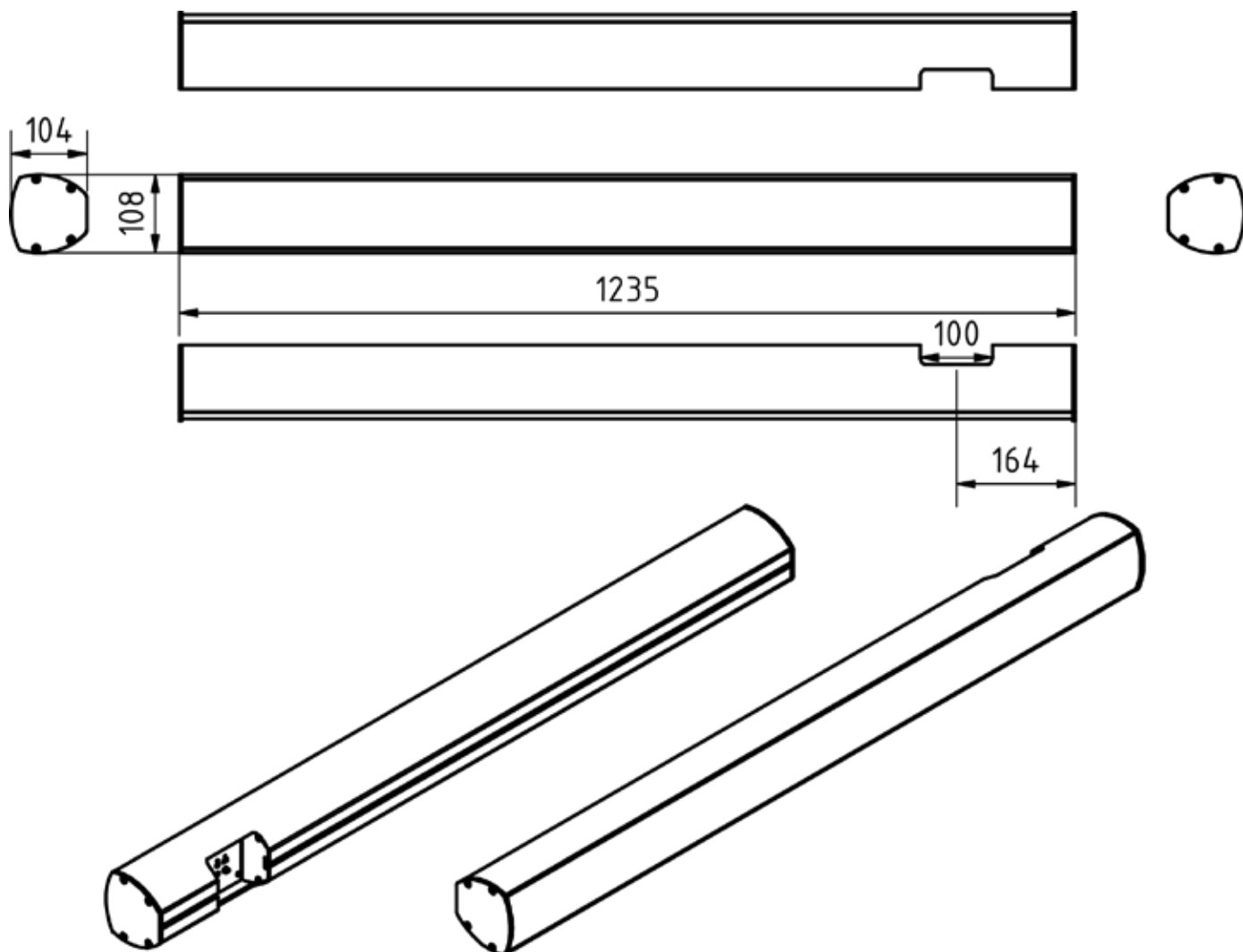

# hd AudioBar 55 Datasheet

## Frequency response with DSP Preset

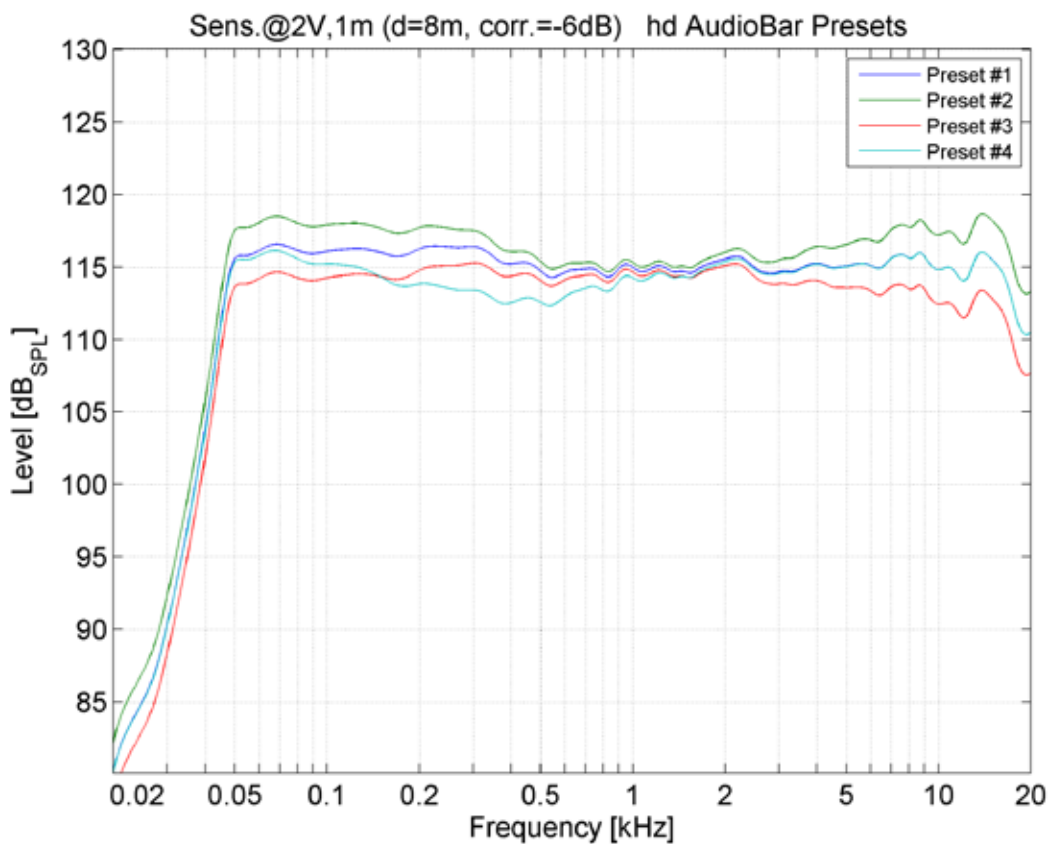

## Connection panel

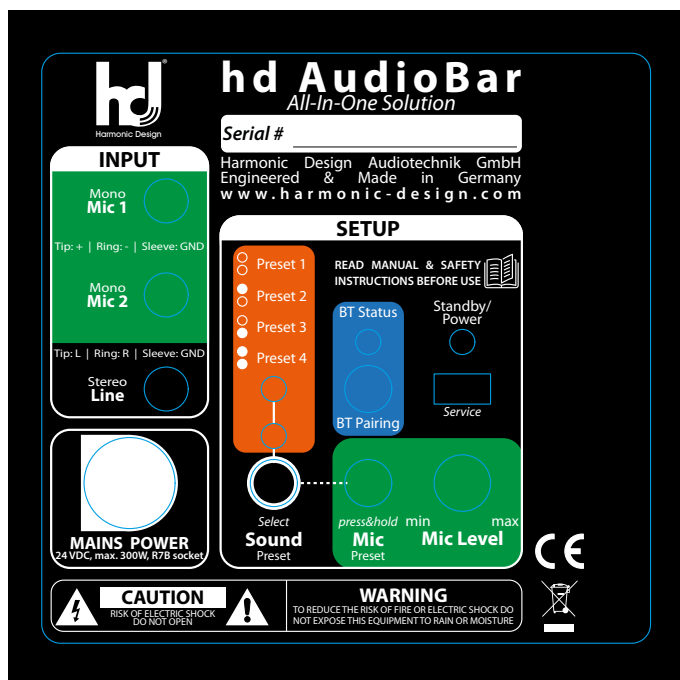

# hd AudioBar 55 Datasheet

## Accessories

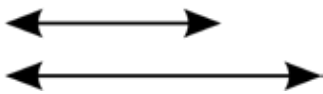

### Special length

Special length of the speaker according to customer requirements.

Order number: 40713 (up to 2000 mm total length)



### RAL-Color

Special color per article according to RAL-Color chart.

Order number: 1070

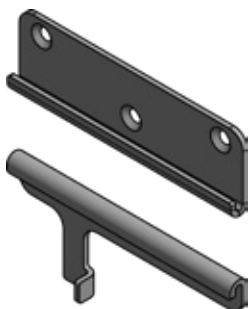

### InvisibleBracket

Wall bracket for invisible attachment to a flat wall with the smallest distance.

Load capacity: 10 kg

Dimensions (W x H x D): 20 x 60 x 80 mm

Order number: 900873



### UniBracket CCX

For table mounting a hd AudioBar in sideboards, TV furniture or other surfaces. Wall mounting also possible including wing screw to adjust the inclination.

Dimensions (W x H x D): 90 x 42 x 130 mm

Order number: 900870BLK (black RAL 9005)

900870W (white RAL 9010)

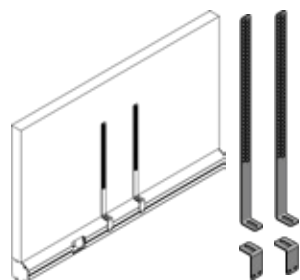

### TVBracket

For the precise installation of an hd AudioBar at the VESA mounting points on the screen. Distance adjustable in height and depth.

Load capacity: 10 kg

Dimensions (W x H x D): 90 x 160 x 110 mm

Order number: 900883

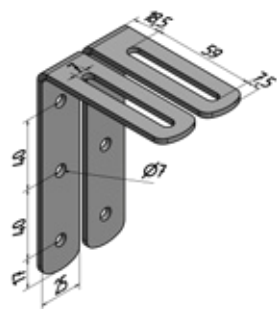

### L-bracket wall mount-set

Discreet L-bracket set for extremely close mounting of the speaker to the wall. Side swivel with inclination up to 5°. The speakers housing plates are equipped with M6 inlet threads. Incl. 2x M6x14 hexagon socket screws.

Load capacity: 30 kg

Dimensions (W x H x D): 20 x 60 x 80 mm

Order number: 900106 (in RAL-Color of speaker)

Engineered  
Made  
In Germany



Harmonic Design

*...simply harmonic sound*

**Harmonic Design  
Audiotechnik GmbH**

Rudolf-Diesel-Straße 11  
DE-74382 Neckarwestheim

+ 49 (0) 7133 / 900 8617  
info@harmonic-design.com  
www.harmonic-design.com