



Audiophile conferencing solutions in hd

Engineered
Made
In Germany

The new **hd AudioBar** and **hd VideoBar**





To be understood at last

No more bad sound quality!

An essential part of human interaction is the sharing of thoughts, visions and feelings through communication. In the professional environment, this is happening more and more with the help of virtual media, e.g. for video conferences and online meetings - without personal contact.

Important aspects such as the dynamics, voice color, articulation, expression and emotions of the counterpart go far beyond pure speech intelligibility. For the experience of an authentic meeting, the full information content of language must not remain on the transmission path. Otherwise the participants' ability to

concentrate and be productive suffers. Misunderstandings are inevitable. The uncompromising use of the latest pro audio technology meets the highest audiophile requirements and combines complex multimedia components in one device that anyone can operate.

With the **hd AudioBar** and **hd VideoBar** you can create a pleasant collaboration environment for a respectful and appreciative encounter between colleagues and business partners without any technical effort.

The All-in-One Solution

hd AudioBar and hd VideoBar



Model

hd AudioBar

hd VideoBar

Customization

✓

✓

Integrated subwoofer

✓

✓

Integrated DSP amplifier

✓

✓

Digital mixer functions

✓

✓

Camera integration possible

✗

✓

A real all-rounder

In all circumstances

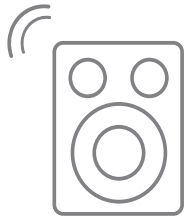

Real music enjoyment



Excellent intelligibility



Perfect picture



Top connectivity



Training



Lecture

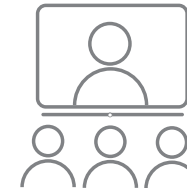

Video conference

NEVER AGAIN TANGLED CABLES

Everything combined in one device

Own ecosystem

The hd AudioBar and hd VideoBar combine loudspeakers, amplifiers, signal processors, mixer, microphone and wireless audio as well as camera technology in one device. Together with a screen and computer, they form a full-fledged collaboration system and make additional components and their complex cabling superfluous.



Plug & Play

Ready to go for every meeting

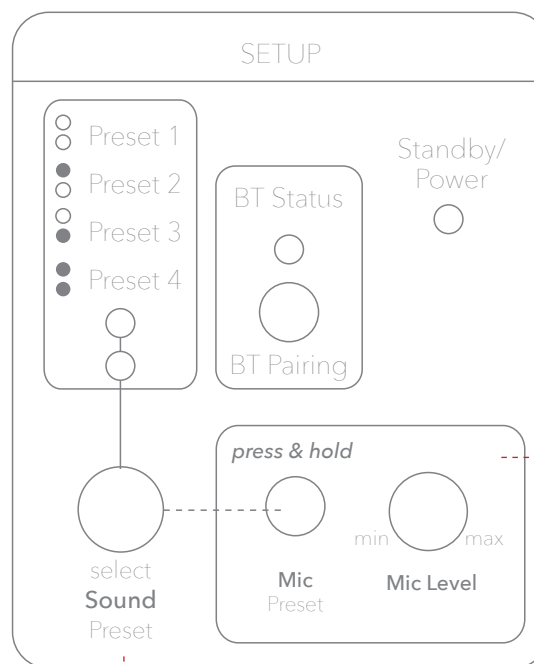
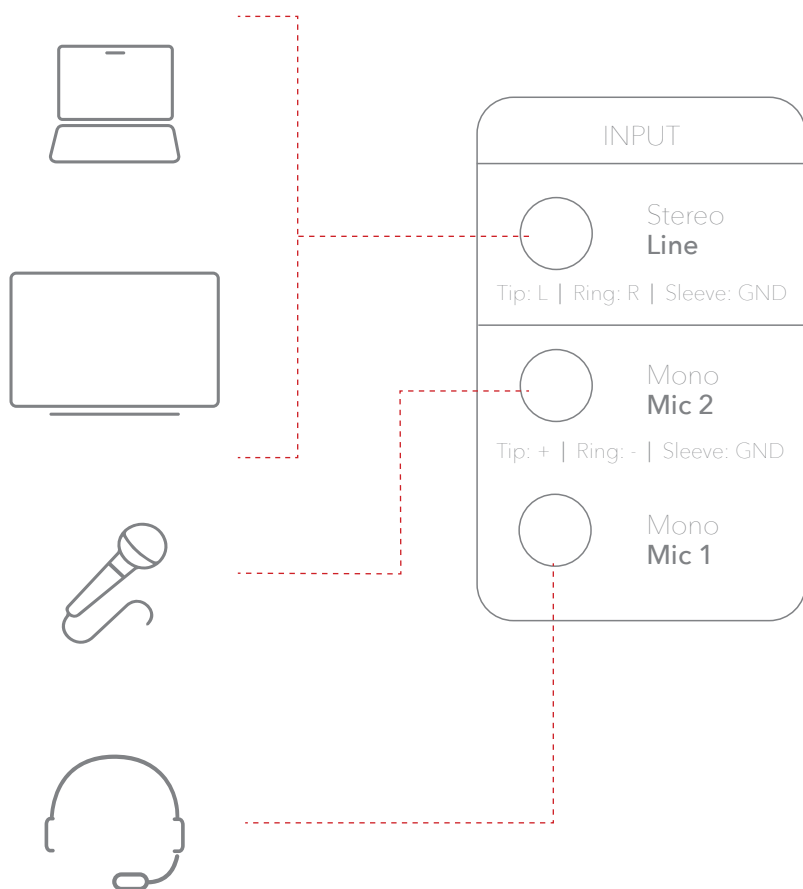

EasyMicSetup

Noise reduction, dynamics adjustment and sound optimization for handheld microphones, headsets, combinations thereof or other line-in with a separate volume control.

EasyTuning

Various sound presets for small rooms, large rooms, an optimization of the intelligibility of video conferences or rooms with high attenuation are available. A 5-band custom EQ is possible via the app control.

hd AudioBar and hd VideoBar

Perfection in the details

Pro-Audio-DNA

At Harmonic Design, no compromises are made when it comes to sound reproduction.

As an owner-managed Swabian company, we live our passion for high-quality loudspeaker and amplifier technology every day and work with great attention to detail on innovative solutions for sound reinforcement tasks, so that our pro audio DNA is contained in every product. We have been doing this for 40 years remained true.

Harmonic Design EAR
(ElectroAcousticResearch)
in-house anechoic half-space
chamber according to class 1
with 1000 m³ room volume.





Engineered
Made
In Germany

Quality promise

Every Harmonic Design product is handcrafted in Germany with the highest standards of precision and quality. We do not rely on distant suppliers, but work together with long-term, regional partners.

Our products are developed and optimized from the ground up in our in-house development department.

The acoustic components such as loudspeaker chassis, crossovers, wave guides or electronic components such as digital signal processors (DSP) and amplifiers through to proprietary software algorithms and user interfaces meet our quality standards.

Stereo loudspeaker

Special dual-concentric speakers ensure that you can enjoy the full sound spectrum in the entire room.

In contrast to normal speakers, our dual-concentric loudspeakers consists of two drivers that have been physically combined into one. The tweeter unit is on the same axis as the woofer unit. This is the only way that the sound energy is radiated evenly in the horizontal and vertical planes and offers exceptional sound quality outside the main direction of radiation.

The symmetrical radiation makes the positioning of the **hd AudioBar** and **hd VideoBar** easier and reaches more listeners. Whether above or below the presentation area: every single nuance is understood.

Conventional speakers

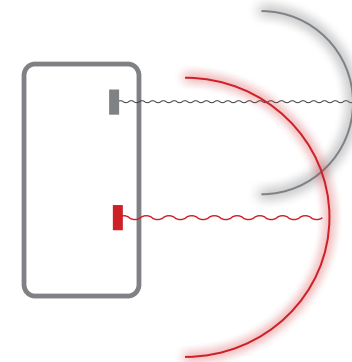
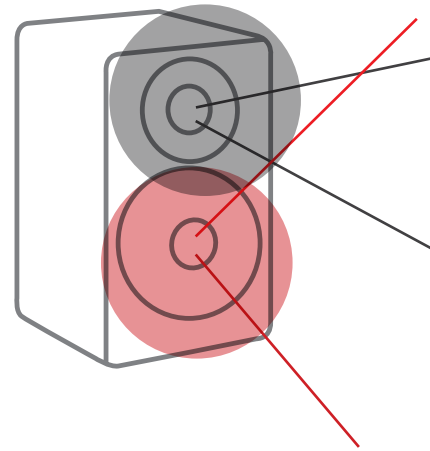

■ low frequency

■ high frequency

hd dual-concentric loudspeaker

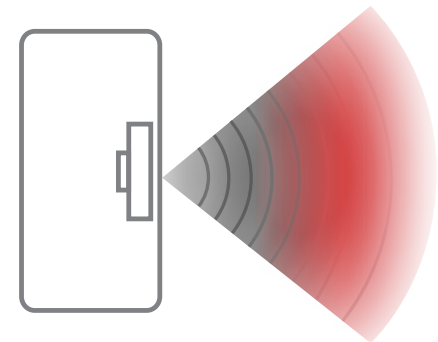
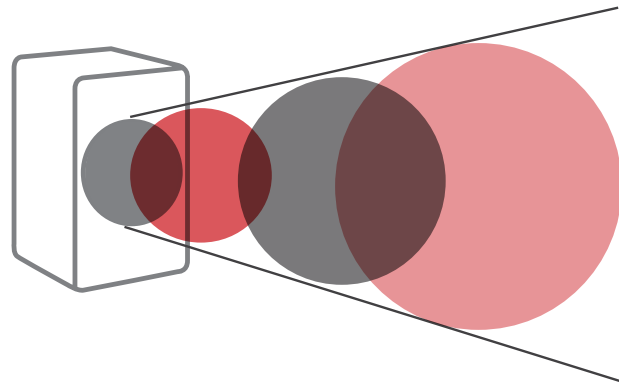



Subwoofer-Array

A soundbar not only has to convince with speech intelligibility, but also give your videos goose bumps in the lowest octave. In contrast to a single subwoofer, an entire subwoofer array ensures a more controlled, profound bass without booming when playing media sound. Pure concert feeling!

But don't worry: thanks to the different signal processing for media sound and speech, your video conferences and presentations remain crystal clear at all times.

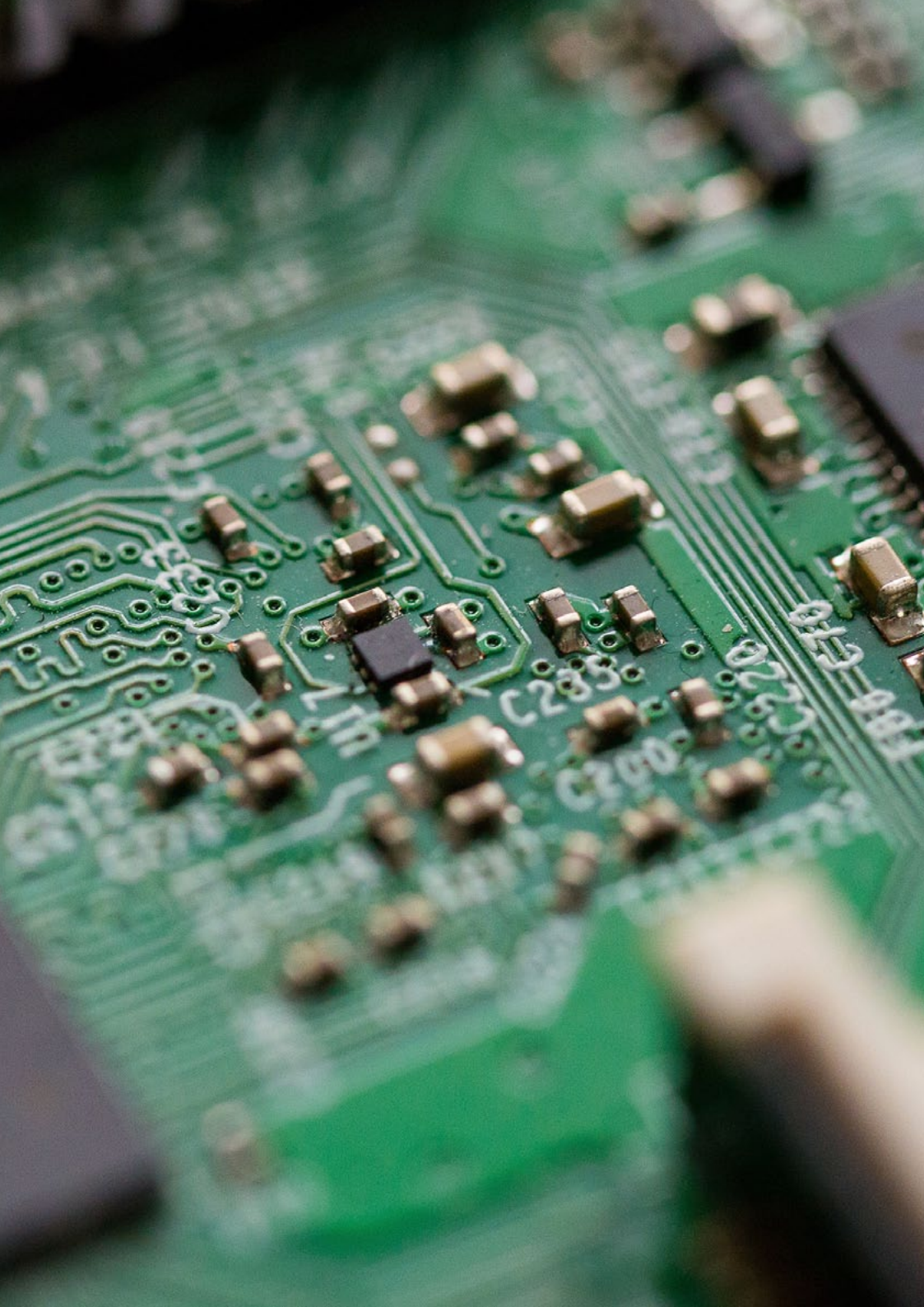

Intelligent control center - ready for the future

A multi-channel digital signal processor based on our hd ProDSP platform is the heart of the system. It manages all inputs and outputs, uses the latest algorithms for sound optimization and is also equipped with highly efficient power amplifiers. As soon as it has been processed and digitized, the audio signal is passed on to the amplifier section in the highest audiophile quality without loss.

BringYourOwnDevice-ready and wireless audio thanks to the integrated wireless interface. For maximum connectivity without cable clutter, the soundbar can play the sound of a TV or any wireless-enabled device with high-resolution audio formats.

As with all Harmonic Design speaker systems, we use FIR filter technology to achieve a perfect sound experience. And when it gets louder, intelligent protective circuits ensure maximum operational safety - 24/7!



Premium audio for speeches and lectures.

The hd AudioBar and hd VideoBar are designed for a wide range of requirements and room scenarios.

They offer a great deal of flexibility and simplicity. All models are equipped with two inputs for a wide variety of wireless microphone components and, thanks to the latest signal processing, are optimized for maximum speech intelligibility in speech applications. After all, you should be able to concentrate on the essentials: on what you have to say.



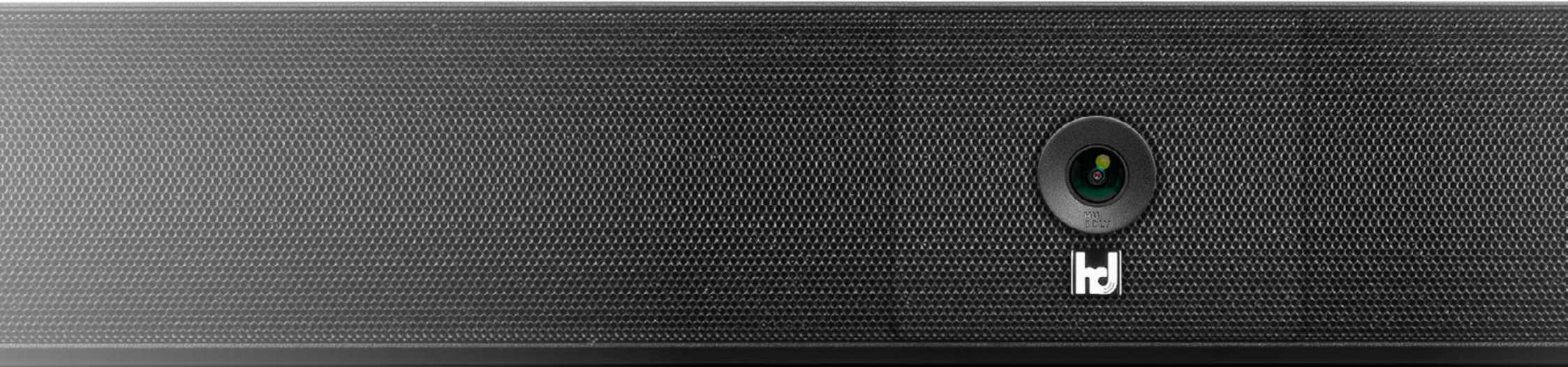

So that you are always at the center of the discussion.

The hd VideoBar enables easy integration of the award-winning Huddly IQ camera. It offers an incomparable video meeting experience with 150° wide-angle optics and groundbreaking AI functions for automated zoom.

Installation is done in next to no time: screw the camera onto the included mounting bracket, insert it into the hd VideoBar from behind, plug in the USB cable - done!



PERFECT INTEGRATION

... standard at **hd** for years

Thanks to flexible manufacturing processes, all column loudspeakers at Harmonic Design have been manufactured with customer-specific lengths, colors, fittings or brackets and thus ideally adapted to your application environment - without long delivery times and high additional costs. Short distances thanks to *Made in Germany*. Because we know that this is exactly what matters. Of course, we offer a whole range of intelligent accessories so that most applications can be covered. And if not? Then contact us!



Fantastic finish

Aluminum housing, cover and front grille with adapted acoustic foam available **in all RAL classic colors**. Other color catalogs and surfaces possible on request.



A perfect fit for every screen

Width of the loudspeaker according to customer requirements suitable **up to 3m - without long delivery times**

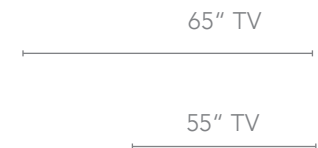

Accessories

Always suitable

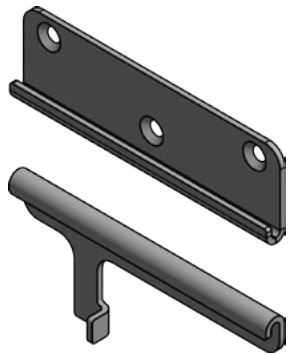

InvisibleBracket

Wall bracket for invisible attachment to a flat wall with the smallest possible distance.

UniBracket

Bracket for table mounting on sideboards, TV furniture or other surfaces. Wall mounting also possible including wing screw for setting the inclination.

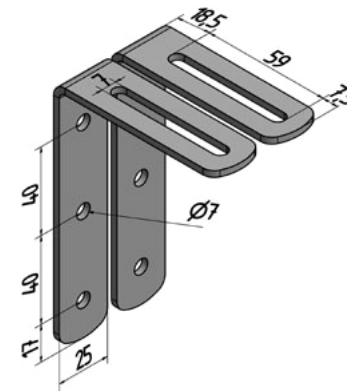

L-Bracket-Set

Discreet L-bracket set for mounting on the wall to be attached. Can be swiveled to the side with an incline of up to 5°. Housing covers are equipped with M6 threads. Incl. 2 x M6 x14 hexagon head screws

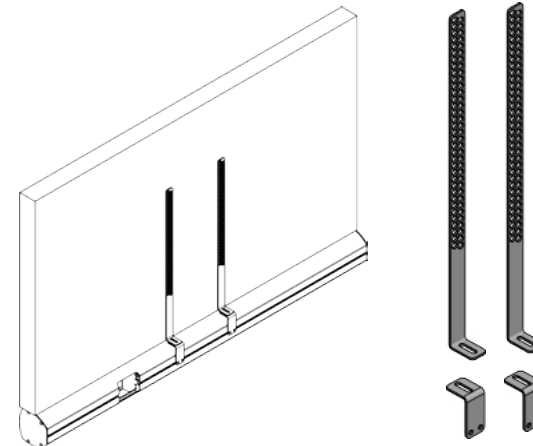

TVBracket

For precisely fitting an hd AudioBar and the VESA mounting conditions of the screen. Distance adjustable in height and depth.

Technical specifications

Model	hd AudioBar	hd VideoBar
Order number	55" Model: 402015-55 / 65" Model: 402015-65	55" Model: 402016-55 / 65" Model: 402016-65
Principle	active 2.1 all-in-one multi-media system with digital mixer functions	
Camera integration	no	optional Huddly IQ, other models on request
Transducers	L/R: 2x 3,5" + 1" Dual-Concentric mid-high unit / Subwoofer: 3x 3,5" high-excursion woofer + 2x 3,5" ultra-high excursion passive radiator	
Coverage (hor x ver)	80° x 80°	
Frequency Response (-6dB)	45 Hz - 22 kHz	
SPLmax @ 10% THD	111 dB	
Amplifier power	300 W RMS	
Audio DSP	hd ProDSP 4+2In 4Out with fully digital signal flow, FIR-/IIR-Filters, RoomEQ, MicEQ, Compressor, Gate, Expander, Matrix, 4 sound presets, 4 mic presets, remote	
Connections	1x stereo 3.5mm-jack line input / 2x mono 3.5mm-jack mic input / wireless audio / 1x Mini-USB / 1x 4-pin power socket for 24V power supply	
Enclosure	powder-coated aluminum profile black, continuous T-slot, grille with acoustic foam, recessed connection field, mic volume pot, 2x preset buttons, BT pairing button	powder-coated aluminum profile black, continuous T-slot, grille with acoustic foam, recessed connection field, mic volume pot, 2x preset buttons, BT pairing button, cable entry in the middle for camera
Options	RAL-color (no. 1070) / various brackets / special length (no. 40713)	
Weight	7 kg	
Dimensions (B x H x T)	55" Model: 108 x 1235 x 104 mm / 65" Model: 108 x 1435 x 104 mm	

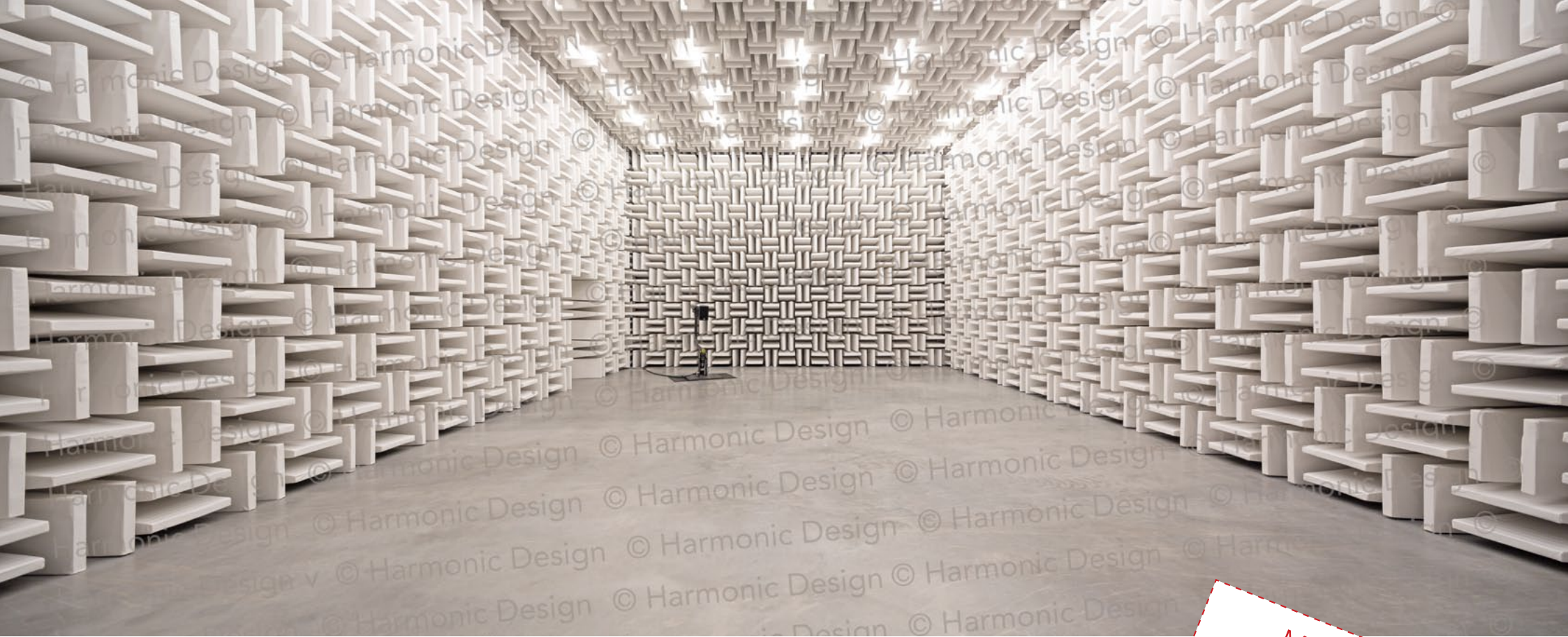

Harmonic Design EAR (ElectroAcousticResearch)
in-house anechoic half-space chamber according to
class 1 with 1000 m³ room volume.

Engineered
Made
In Germany



...simply harmonic sound

*Make an
appointment now!*

Harmonic Design
Audiotechnik GmbH
Rudolf-Diesel-Straße 11
DE-74382 Neckarwestheim

+49 (0) 7133 / 900 8617
info@harmonic-design.com
www.harmonic-design.com

© 01/2021 Harmonic
Design GmbH,
All Rights Reserved

Harmonic Design® is a
registered trademark.
Specifications subject to
change without prior notice