

Company	Date	Contact
---------	------	---------

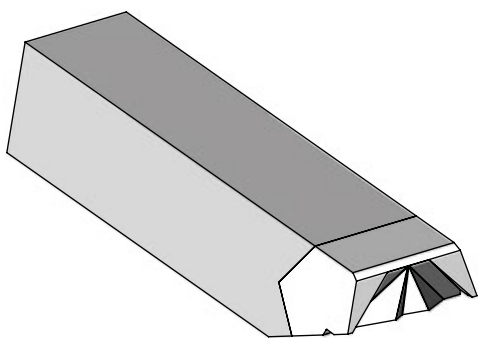

Type	
L	
A	
B	
C°	

Ballistic Point

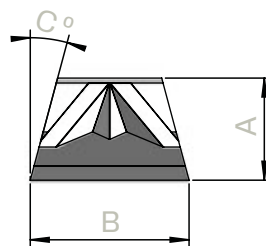
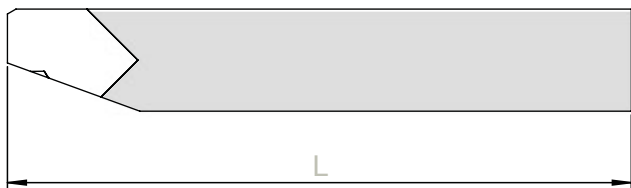
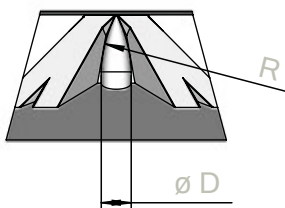

Diamond

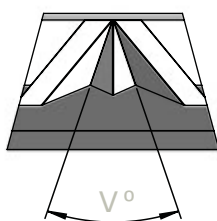

Round Point

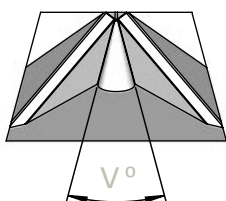

Star

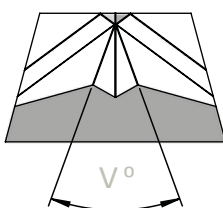

Type	
$\varnothing D$	
V°	
R	