

BAUER

Solartechnik GmbH

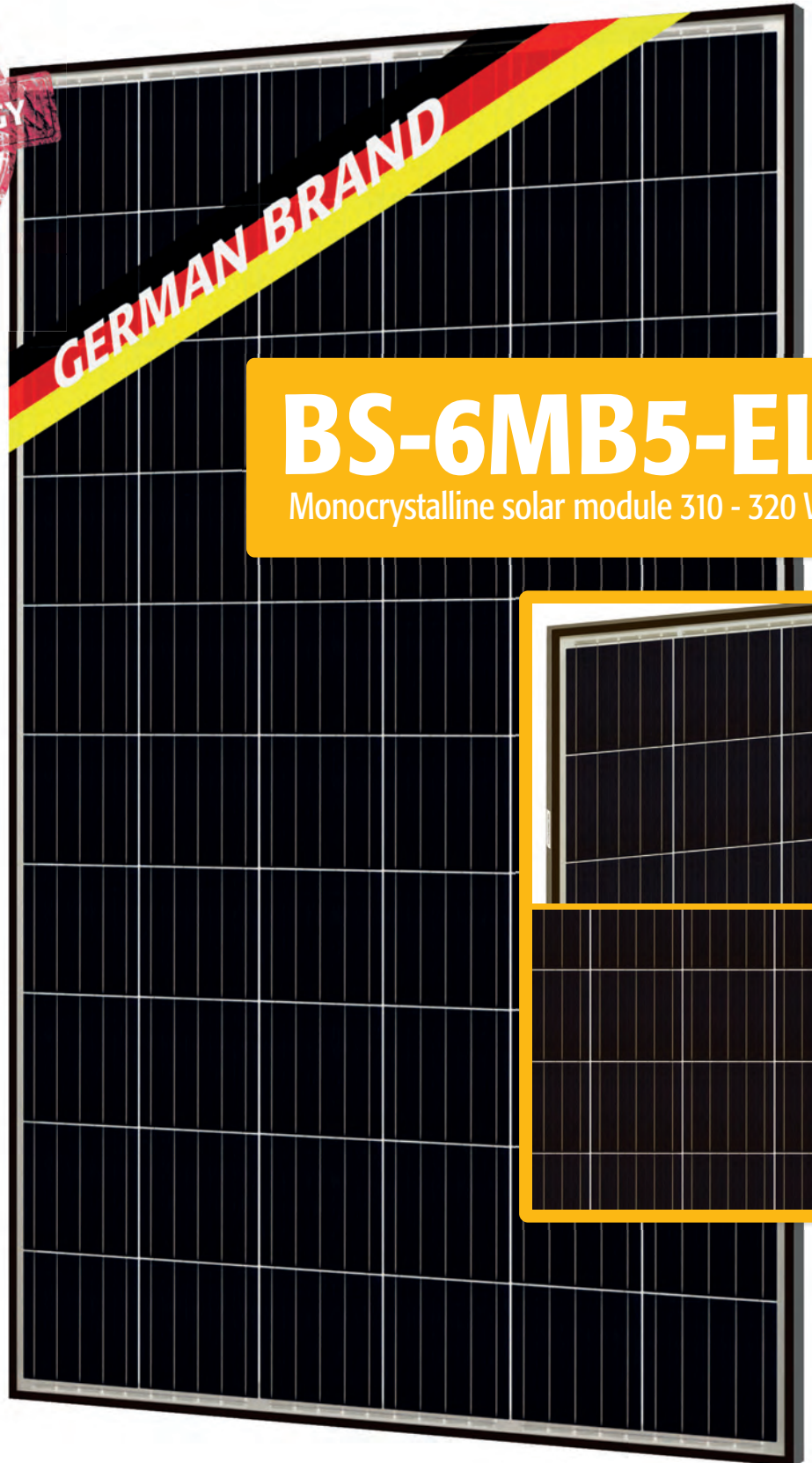

BS-6MB5-EL

Monocrystalline solar module 310 - 320 W

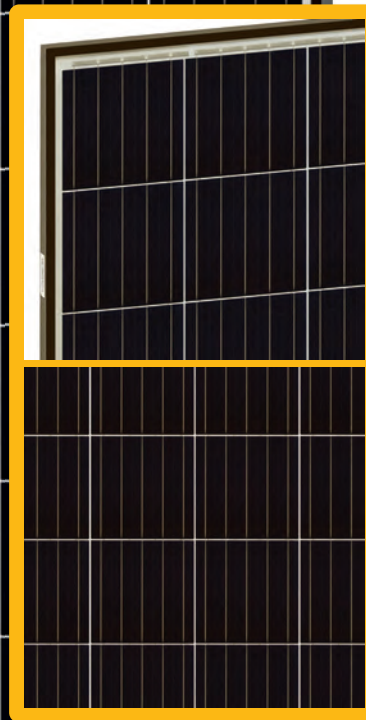

PERFORMANCE GUARANTEE

20 years product warranty and a linear performance guarantee over a period of 25 years



CERTIFICATION

Permanent in-house quality control, multiple certifications by accredited inspection bodies



EFFICIENCY

High efficiency for optimum yield - innovations directly influence the production process



POSITIVE POWER TOLERANCE

Exclusive delivery of solar modules with positive power tolerance only



WEATHER-RESISTANT

Standardized mechanical load test guards against damage from wind and weather



GERMAN GUARANTOR

In case of need it is ensured that a German company assumes the claim settlement



SAFETY

High-quality components ensure maximum protection in all weather conditions



PID TEST

The solar cells of our high performance modules are tested for PID



REINSURANCE COVERAGE

The cooperation with MunichRe is guaranteeing BAUER even higher levels of financial stability & reliability - BAUER is insured for 12 years of the product's warranty and 25 years of the product's performance guarantee



PROVEN & GUARANTEED BY
BAUER SOLARTECHNIK

HIGH QUALITY STANDARDS BY GERMAN ENGINEERS

Mechanical Data

Cell type	monocrystalline / PERC
Cell formation	6 x 10 (60)
Module dimensions	1640 x 990 x 35 mm
Weight	18,3 kg
Front cover	tempered glass, 3,2 mm
Frame material	anodized aluminium alloy
Module back	TPT foil
Embedding material	EVA
Connection	junction box \geq IP 67
Number of diodes	3 x 2 bypass diodes
Cabel / connector	4 mm ² , 900 mm, MC4-compatible

Temperature coefficients

Nom. operating cell temp. (NOCT)	45°C \pm 2
Temperature coefficient of I_{sc}	+0,050 %/K
Temperature coefficient of V_{oc}	-0,290 %/K
Temperature coefficient of P_{mpp}	-0,390 %/K

Operational conditions

Maximum system voltage	1000 V DC (TÜV)
Operating temperatur	-40 bis 85°C
Maximum series fuse rating	20 A
Static load (snow/wind)	5400 Pa
Hail	\varnothing 25 mm bei 23 m/s

Electrical data¹

	BS-310-6MB5-EL	BS-315-6MB5-EL	BS-320-6MB5-EL
Nominal maximum power P_{max} (W _p)	310 W	315 W	320 W
Power output tolerance P_{max} (%)	0 ~ +3	0 ~ +3	0 ~ +3
Optimum operating voltage V_{mpp} (V)	32,60	32,80	33,00
Optimum operating current I_{mpp} (A)	9,52	9,61	9,70
Short circuit current I_{sc} (A)	9,87	9,95	10,03
Open circuit voltage V_{oc} (V)	40,10	40,20	40,40
Module efficiency η_m (%)	19,09	19,40	19,71

Dimensions

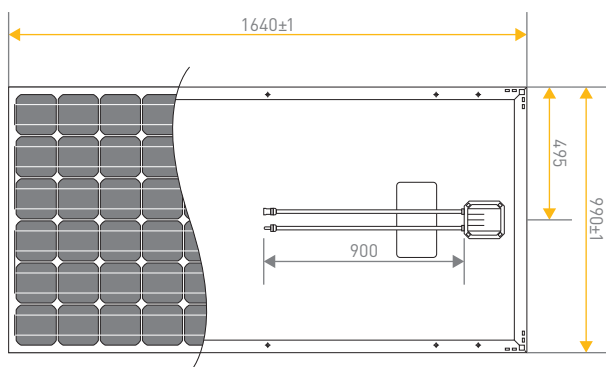

Warranty conditions²



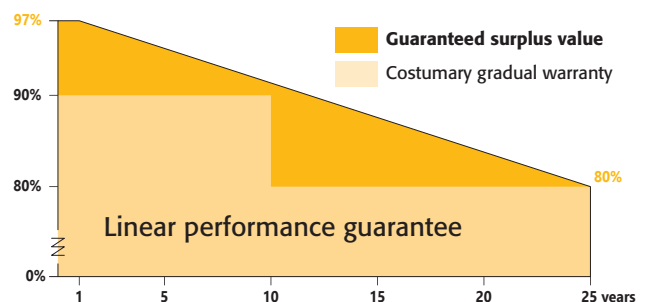

Product warranty	20 years
Performance guarantee	25 years (min. 80% after 25 years)



Packaging units

Modules per pallet	30 pcs
Modules per truck	840 pcs

Qualification & certification

IEC 61215-1/-2(ed.1), IEC 61215-1-1(ed.1)		
IEC 61730-1(ed.2), IEC 61730-2(ed.2)		

¹Values under Standard Test Conditions (STC): air mass 1,5 AM, irradiance 1000 W/m², cell temperature 25°C. STC measuring tolerance: \pm 3 % (P_{max}), \pm 10 % (V_{max} , I_{mpp} , V_{oc} , I_{sc}). ²Nominal value is specified in the written warranty conditions. A possible light-induced degradation in power is not taken into account. The beneficiary under the reinsurance policy of MunichRe is solely Bauer Energiekonzepte GmbH. Please contact us to get information on how this insurance coverage benefits you as a customer. Note: Please read safety instructions and installation manual before using this product. Subject to change. © 2019 Bauer Energiekonzepte GmbH. Effective 18th of november 2019.



Distribution:

BAUER 
ENERGIEKONZEPTE

Bauer Energiekonzepte GmbH
Hinter der Mühle 2 · D-55278 Selzen

Phone: +49 (0) 6737 - 8081 - 60
Fax: +49 (0) 6737 - 8081 - 66

info@bauer-energiekonzepte.de
www.bauer-energiekonzepte.de