

SIGNLUX™

Fixing brackets

multi bracket

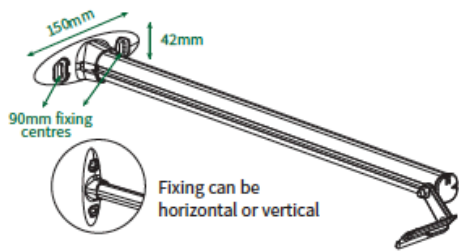

uni bracket

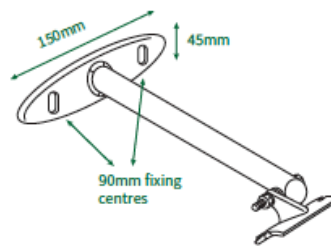

adjustable steel bracket

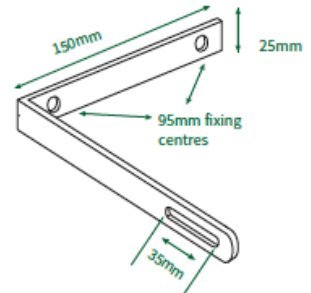

All can be supplied as 50mm, 100mm, 200mm, 300mm, 400mm and 500mm projections.

optional mounting bracket

Vertical twist bracket

Ideal for claddings

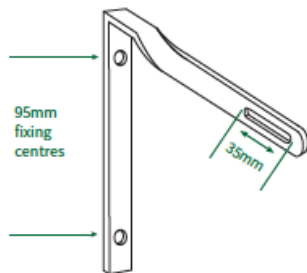

Flat twist bracket

Ideal for flat fixings

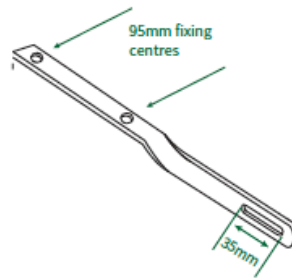

30 degree angle bracket

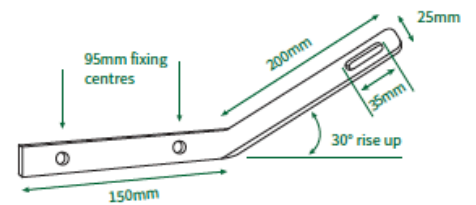

All can be supplied as 100mm, 300mm, 400mm and 500mm projection as extra.

others

Pictorial bracket set

Ideal for back to back signs

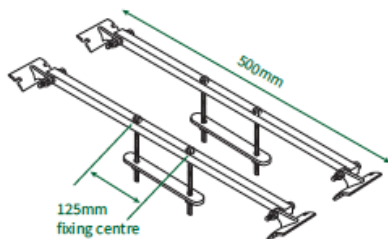

970mm land bracket

For free standing billboards & large format signs

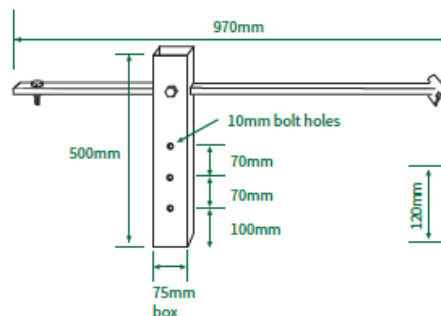

650mm gable bracket

For wall mounted billboards and large format signs

