



ELSEVIER

International Journal of Pharmaceutics 189 (1999) 57–65

international
journal of
pharmaceutics

www.elsevier.com/locate/ijpharm

Apparatus for studying in vitro drug release from medicated chewing gums

Catharina Kvist^a, Sven Börje Andersson^a, Susan Fors^a, Bo Wennergren^b,
Johan Berglund^{a,*}

^a Pharmacia and Upjohn, Consumer Healthcare, Research and Development, P.O. Box 941, SE-251 09, Helsingborg, Sweden

^b AB FIA Odarslövs mölla, Öresundsvägen 14, SE-227 64, Lund, Sweden

Received 4 June 1999; accepted 8 July 1999

Abstract

An apparatus for in vitro drug release testing of medicated chewing gums has been developed and is described in detail. The effects on the drug release when varying critical instrumental settings such as the chewing stroke frequency, the distance between the chewing surfaces, the twisting movements of these surfaces and the temperature of the test medium have been thoroughly investigated. It has been shown that the drug release can be tuned to obtain suitable drug release profiles for a number of products: Nicorette[®] and Nicotinell[®] (active substance nicotine), Travvell[®] (dimenhydrinate), V6[®] (xylitol) and an experimental formulation containing meclizine. The main usage of the present apparatus should be within quality control but the present study has also shown that it may be employed within development pharmaceutics since useful in vivo/in vitro relationships may be obtained due to the versatile settings of the critical instrumental parameters. © 1999 Elsevier Science B.V. All rights reserved.

Keywords: Medicated chewing gum; Release equipment; Nicotine; Meclizine; Xylitol; Dimenhydrinate

1. Introduction

Chewing gums are interesting as an alternative drug delivery system when considering oral or per oral administration of drug substances since they may offer a number of advantages over conventional tablet administration; convenient and individually controlled release of the active substance, effective buccal drug administration for treatment of local oral diseases or avoidance of first pass

metabolism, just to mention a few (Rassing, 1996). Medicated chewing gums have been formulated and commercialized for delivery of a number of various active substances, e.g. nicotine (used for nicotine replacement therapy), dimenhydrinate and meclizine (used for treating motion sickness), aspirin, and xylitol (sugar free chewing gum) etc.

In vitro dissolution and drug release testing of tablets and capsules are well established and apparatuses and standardized methods are described in the pharmacopoeias. However, these methods are not suitable for studying the release of active

* Corresponding author.

substances from chewing gums since here a continuous mastication is needed for release of the drug. The release of drug substances from chewing gums have sometimes been quantified by chew-out studies where volunteers chew a gum for a certain time period and the gum is then analyzed for the remaining amount of active substance (Woodford and Lesko, 1981; Nemeth-Coslett et al., 1988; Rider et al., 1992). This approach has some obvious disadvantages since it is difficult to standardize and more than one gum is needed to obtain a full release profile. Some *in vitro* dissolution chewing apparatuses have been described but no international standards have so far been set for controlled release tests of medicated chewing gums (Kleber et al., 1981; Christrup and Möller, 1986; Liljewall, 1989, 1992; Rider et al., 1992; Rassing, 1996). Pharmacopoeial guidelines state that in general, solid oral dosage forms in which absorption of the drug is essential for the therapeutic effect should be tested for *in vitro* drug release in order to guarantee the biopharmaceutical quality of the product (Gray and Grady, 1997; Siewert, 1995). The increasing interest in chewing gums as drug delivery vehicles therefore calls for development of robust *in vitro* drug release equipment and standardized test methods also for gums.

We here describe an apparatus developed for *in vitro* dissolution of drug substances from medicated chewing gums. Specifically, important characteristics governing the release of the active substance to the test medium are discussed. Release profiles of drug substances from some commercially available products are also presented.

2. Materials and methods

2.1. Technical description of the *in vitro* chewing release apparatus

A drawing of the chewing apparatus is shown in Fig. 1a. The apparatus has six chewing modules (Fig. 1b). Each module consists of a thermostatted test cell of glass in which two vertically oriented pistons holding an upper and a lower chewing surface, respectively, are mounted. The

cells are filled with an appropriate test medium, usually 25–50 ml of an aqueous medium, and the chewing gum is loaded onto the lower chewing surface. The chewing procedure consists of up and down strokes of the lower surface in combination with a twisting movement of the upper surface which provides a mastication of the chewing gum and at the same time, an adequate agitation of the test medium. The upper chewing surface is connected to a stand in a locked position but revolves on its axis when performing the twisting movement. The test cell is connected to the lower chewing surface which is fixed against revolving movements during the up and down strokes. The movements of the pistons are driven by compressed air. The distance settings of the chewing surfaces, the frequency of the strokes, as well as the angle of the twisting movement are adjustable. The chewing surfaces, manufactured from acid-resistant stainless steel, are circular with a blasted surface to counteract gliding of the chewing gum. The upper chewing surface is parallel to the central part of the lower one. The lower surface has a small brim, leaning upwards in a 45° angle thus forming a small bowl with a flat bottom preventing the gum from sliding. For some applications it has been found practical to use a pair of rigid nylon net discs sandwiching the chewing gum in order to position it on the lower chewing surface and prevent it from splitting into smaller pieces. The whole lower chewing surface and cell unit is connected to a lift which may be lowered during preparation, during sampling of the test medium and when emptying the cell after completion of the release test. Thermostating is achieved by use of a brass chamber in thermal contact with the lower surface. The upper chewing surface is not heated but attached to a torsion axis made of a heat insulating polymer. The thermostatted test cell is transparent which facilitates visual inspection during the run.

2.2. Adjustments and settings

Most of the parameters affecting the release from the gum are adjustable *i.e.*: the temperature of the test medium may be adjusted within the range 25–45°C, the chew frequency may be set to

12–120 strokes per min, the chewing time is freely adjustable, the distance between the chewing surfaces (in their innermost position) is adjustable between 0 and 10 mm and the torsion angle may be set within the range 5–180°. However, the settings of the stroke frequency and the torsion angle are interdependent and not all combinations are possible; i.e. choosing a high stroke frequency may limit the choice of twisting angle. If needed, the range of possible settings may be expanded by increasing the effect of the apparatus by increasing the airflow or pressure of the compressed air. The chewing surfaces have a specified roughness which is obtained by a blasting procedure. The apparatus is equipped with frequency monitors for each cell and pressure monitors displaying the chewing force may also be added as an optional device.

The test cell is filled with a minimum of 20 to a maximum of 70 ml of a test medium which prefer-

ably should be a neutral aqueous fluid. The release profile of the drug compound can be optimized by carefully choosing the composition of the test medium; different modifiers can be used for this purpose, e.g. buffering salts are frequently used to stabilize pH and surfactants may be added to lower the surface tension of the medium. Media containing stronger acid or bases may be needed in certain cases to achieve an adequate solubility. The volume of the test medium is large enough to permit repeated sampling and construction of multi-point release profiles. Also, the possibility to use volumes up to 70 ml minimizes the risk of approaching the saturation limit of the test substance.

The test cell is easily removable in order to simplify cleaning. Often the chewing surfaces will be contaminated with sticky remains of the gum and they are therefore difficult to clean. The construction of the apparatus makes removal of

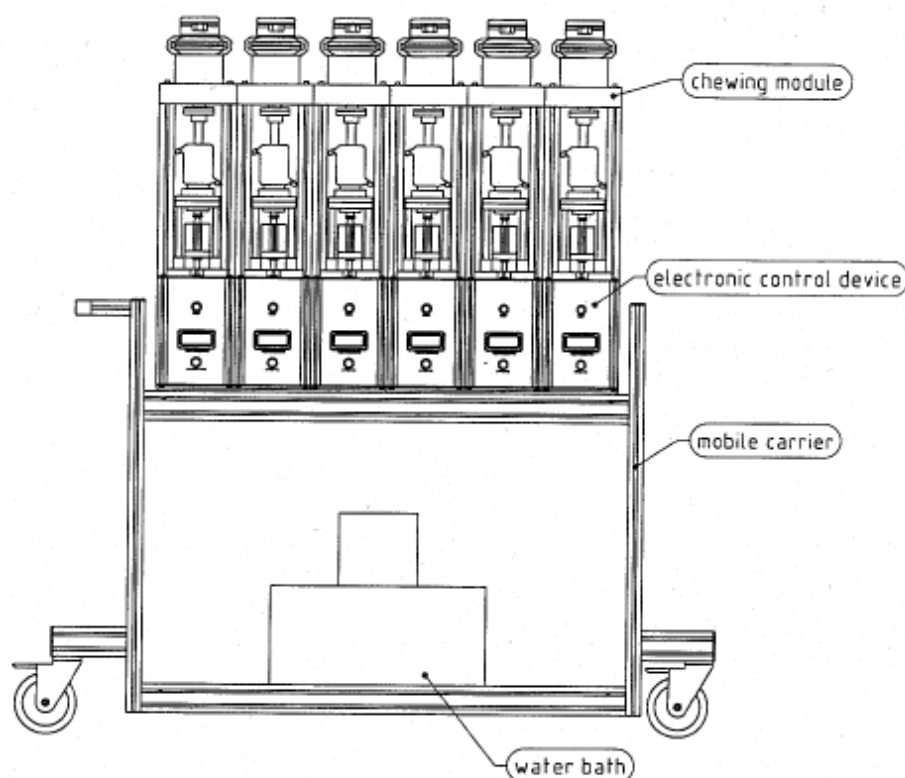

Fig. 1a. Technical drawing of the chewing apparatus. The entire setup showing the six chewing modules.

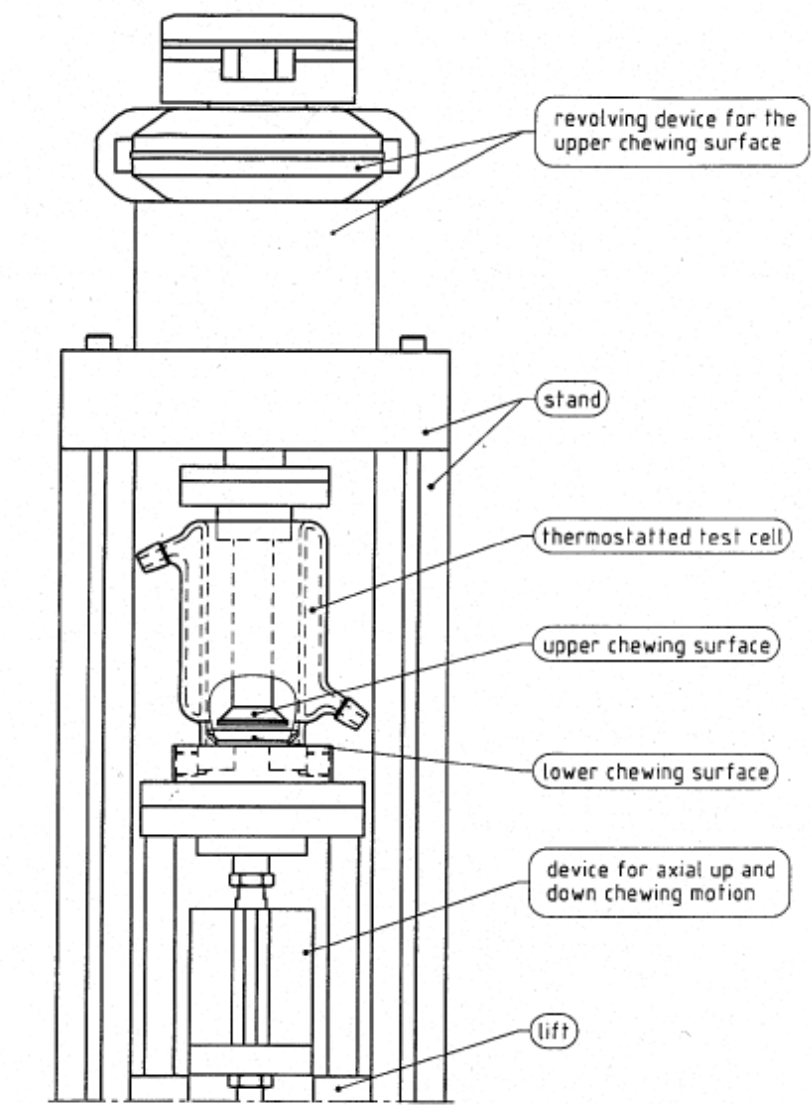

Fig. 1b. Detail of one chewing module.

the the chewing surfaces possible in just a few seconds for easy replacement with new ones. The whole process of cleaning the test cell, refilling the dissolution medium, preheating it and adding new gums takes typically about 30 min for all six cells.

2.3. Testing of pharmaceutical chewing gums

The following commercial chewing gum prod-

ucts were used in the present study: Nicorette® 2 mg Classic (Pharmacia and Upjohn) and Nicotinell® 2 mg (Novartis) both with nicotine as active substance, V6® containing 40 mg xylitol (Fertin), experimental chewing gum with 25 mg meclizine as the active substance and Travvell® (Asta Medica) with 20 mg dimenhydrinate as active substance.

2.4. Standardized conditions for the release tests

The following default settings were used during the release runs if not specified otherwise: chew frequency, 40 strokes/min; distance between the chewing surfaces, 1.6 mm; twisting angle, 20°; temperature, 37°C. For all samples, except for chewing gums containing meclizine and dimenhydrinate, the test medium contained 40 ml of an aqueous solution of 0.1% dodecyl sodium sulfate. For chewing gums containing meclizine, 0.05 M sulfuric acid was used as test medium and water was used for dimenhydrinate. A sample volume of 0.5 ml was withdrawn from each test cell at different times during a release run. The samples were centrifuged before high performance liquid chromatography (HPLC) analysis.

2.5. Chemical analysis

The release samples were all analyzed using HPLC applying different methods depending on the active substance. All chemicals and solvents were of pro analysi and HPLC grade quality, respectively. Nicotine was chromatographed using a 4 µm C18 Genesis (Sorbent) 100 × 4.6 mm column. The mobile phase consisted of 40% 0.08 M phosphate buffer pH 6.5 and 60% methanol. Fifty microliters of a sample was injected, the flow was 1.0 ml/min and the monitoring wavelength was 260 nm. Xylitol was determined by use of a differential refractometer detector and separation was obtained using a 10 µm carbohydrate column, µBondapak NH₂ (Waters) with dimensions 300 × 3.9 mm. The mobile phase was a mixture of acetonitrile and water (75:25). The flow rate was set to 1.0 ml/min and the injection volume to 10 µl. Meclizine was determined using a 5 µm Nucleosil C18 column (Hicrom) with dimensions 250 × 4.6 mm. The mobile phase was a mixture of 0.10 M phosphate buffer with pH 2.5 and acetonitrile (30:70). The flow rate was set to 1.3 ml/min and the monitoring wavelength was 230 nm. The injection volume was 20 µl. Dimenhydrinate was chromatographed on a 4 µm Nova-Pak C18 column (Waters) with dimensions 100 × 5 mm. The mobile phase was a mixture of 0.05 M phosphate buffer with pH 3.0 and acetonitrile

(80:20). The flow rate was set to 1.0 ml/min, the injection volume was 15 µl and the monitoring wavelength was 285 nm.

2.6. In vivo chew-out study

Nicorette® Classic chewing gums, 2 mg were chewed by a test panel consisting of eight trained members. Each person chewed a total of three gums. A used gum was replaced with a new one after 2, 10 and 45 min, respectively, the remaining amount of nicotine in each gum was analyzed and a release curve was constructed from the mean values.

3. Results and discussion

In order to release the active substance, medicated chewing gums have to be masticated since only insignificant amounts of the drug substance are expected to be released by simple diffusion to the surrounding medium. The non-soluble part of the gum matrix will continue to exist as a separate solid phase during the whole chew-out process. Obviously, for an in vitro release test of medicated chewing gums it is of fundamental importance that the test apparatus is able to knead the whole gum uniformly to obtain reproducible results. Chewing gums may glide upon mechanical treatment or stick to the kneading surfaces. Any part of the gum that escapes kneading will have a retarded release of the active substance. To minimize these effects, the lower chewing surface has been designed in the form of a shallow bowl. Furthermore, both chewing surfaces are blasted to achieve a rugged surface. As indicated above, it is sometimes recommendable to use rigid nylon nets to further reduce the risk of breaking the gum or create gliding of it during the chew cycle. In accordance with guidelines for dissolution apparatuses in general, the test cell of the chewing apparatus is fully transparent allowing for visual inspection of the chewing process (Cantor, 1981). As shown by data from release studies of a number of different medicated chewing gums (Figs. 6–8) the present chewing apparatus is suitable for release studies of these types of formulations.

The chewing intensity (determined by the settings of the chewing frequency, distance between

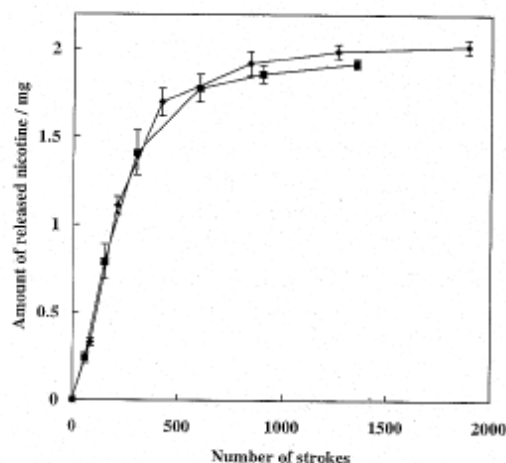

Fig. 2. Evaluation of the effect of stroke frequency on the release. Exemplified by nicotine release from Nicorette® 2 mg Classic (Pharmacia and Upjohn). Conditions: see Section 2.4. Each point represents the average of six gums and the error is given as 1 S.D. Key: 40 strokes/min (squares), 30 strokes/min (diamonds).

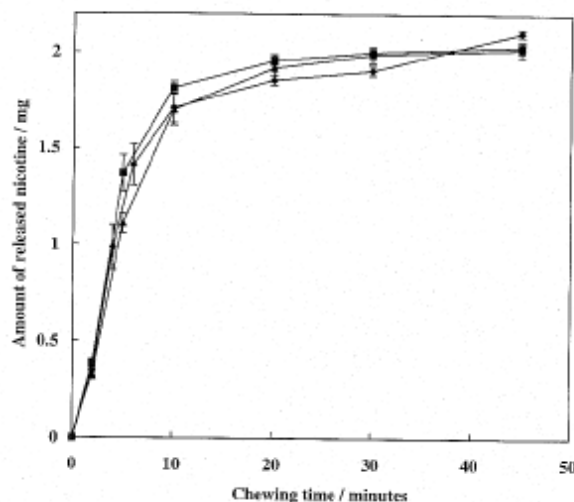

Fig. 3. Evaluation of the effect of changing the delay time before sampling. Exemplified by nicotine release from Nicorette® 2 mg Classic (Pharmacia and Upjohn). Conditions: see Section 2.4. Each point represents the average of six gums and the error is given as 1 S.D. Key: instant sampling (triangles), 15 min before sampling (diamonds), 30 min before sampling (squares).

the chewing surfaces and the torsion angle) and the temperature of the test medium are of fundamental importance for obtaining reproducible release using the present chewing apparatus. The stability of the settings for these parameters in all six modules has been studied during a 90 min dissolution test of Nicorette® nicotine chewing gum, 2 mg, using the standard settings for this product (see Section 2.4). It was found that the chewing frequency could be kept within the range 40 ± 2 strokes/min, the distance between the chewing surfaces and the torsion angle did not change at all and the temperature of the test medium was within the range $37.0 \pm 0.2^\circ\text{C}$ during the whole run. When increasing the stroke frequency, the release rate increases. However, as shown in Fig. 2, the release of nicotine per stroke is basically independent of the chewing frequency (30 or 40 strokes per min) which supports the important basis of the test method that it is the chewing that triggers the release of the drug substance and not passive diffusion to the surrounding medium. This view is further strengthened by the results presented in Fig. 3 where the delay time before sampling has been varied from 0 to 30 min; i.e. the chewing was stopped and a sample was withdrawn either directly, after 15 min or after 30 min before starting the chewing again. The results clearly show that the delay time within this range does not influence the appearance of the release profile for nicotine. As anticipated, decreasing the distance between the chewing surfaces from 1.8 to 1.6 mm leads to an increased rate of release (Fig. 4), since the force acting on the gum is larger with the 1.6 mm setting. At a constant stroke frequency, the twisting angle setting influences the release rate. Test runs using the Nicorette® reference product showed that at a stroke rate of 40 strokes/min, the release rate increased when increasing the twisting angle from 5 to 20° but a further increase to 40° , which under these conditions was the maximum possible torsion angle, did not have any additional effects on the release rate. For any equipment used for dissolution testing of chewing gums it is of the utmost importance that the temperature is thoroughly controlled, since the texture of the formulation changes rapidly with the temperature of the

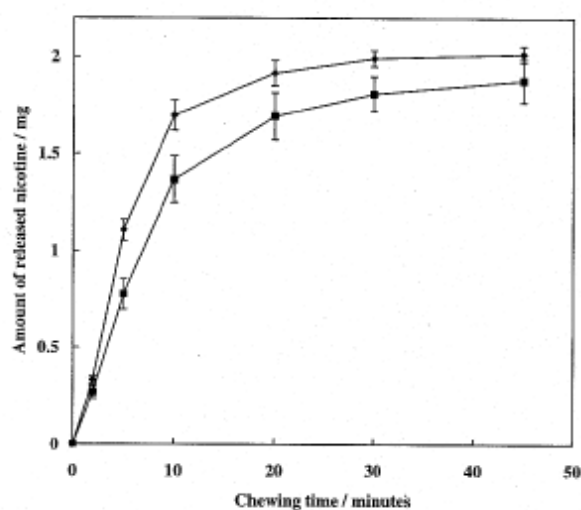

Fig. 4. The effect on the release when varying the distance between the upper and lower chewing surfaces, exemplified by nicotine release from Nicorette® 2 mg Classic (Pharmacia and Upjohn). Conditions: see Section 2.4. Each point represents the average of six gums and the error is given as 1 S.D. Key: distance between the chewing surfaces, 1.6 mm (diamonds); 1.8 mm (squares).

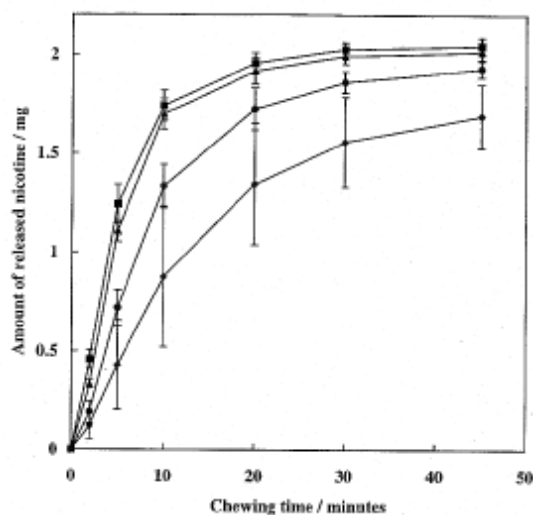

Fig. 5. Release as a function of test medium temperature. Exemplified by nicotine release from Nicorette® 2 mg Classic (Pharmacia and Upjohn). Conditions: see Section 2.4. Each point represents the average of six gums and the error is given as 1 S.D. Key: test medium temperature, 30°C (diamonds), 34°C (circles), 37°C (triangles), 40°C (squares).

test medium. Fig. 5 shows the effects of increasing the temperature from 30 to 40°C using the default setting for the Nicorette® gum described above. The release rate increases with increasing temperatures and the assay also becomes increasingly precise.

A major advantage with the present apparatus is its versatility in the settings of the important parameters described above. This provides a great opportunity to tune the release rate of the active substance from various chewing gums and obtain reproducible release profiles on a reasonable time scale. We emphasize that it is our belief that the main use of any chewing gum release equipment should be within quality control. Using default settings of the critical parameters, gums from regular production batches should be tested with respect to the release of the active substance in a similar fashion which today is general practise for release of tablet batches. In order to exemplify the use of the present apparatus for release studies of other products than the one we have chosen as a reference (Nicorette®) we have studied the release from some other commercially available products. Fig. 6 shows that the release of nicotine from Nicorette® and Nicotinell® chewing gums are very

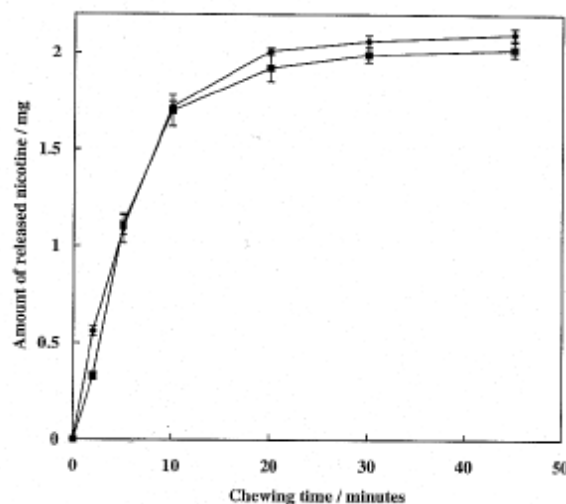

Fig. 6. Release of nicotine from two different chewing gum formulations, Nicorette® 2 mg Classic (Pharmacia and Upjohn) and Nicotinell® 2 mg (Novartis). Conditions: see Section 2.4. Each point represents the average of six gums and the error is given as 1 S.D. Key: Nicorette® (squares), Nicotinell® (diamonds).

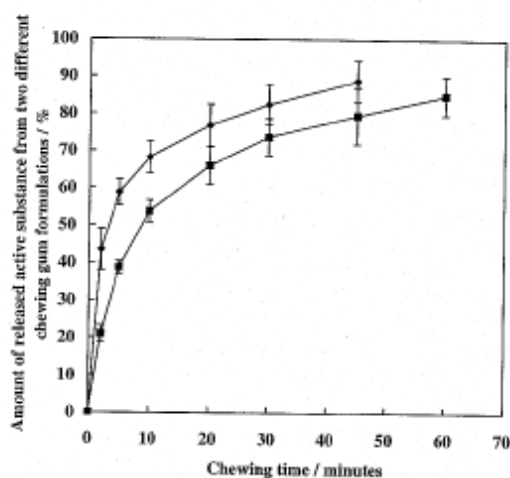

Fig. 7. Release from two different motion sickness products containing 25 mg meclizine (experimental chewing gum) and 20 mg dimenhydrinate (Travvell[®], Asta Medica), respectively, expressed as percentage of label claim. Conditions: see Section 2.4 (except the settings for the distance between chewing surfaces which was 1.8 mm for both formulations). Each point represents the average of six gums and the error is given as 1 S.D. Key: experimental chewing gum, 20 mg meclizine (diamonds), Travvell[®], 20 mg dimenhydrinate (squares).

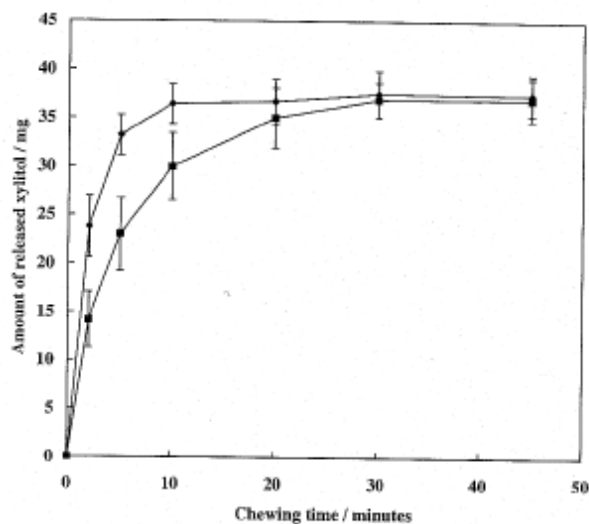

Fig. 8. Release of xylitol from a chewing gum containing 40 mg xylitol using two different settings of the distance between the chewing surfaces. Conditions: see Section 2.4. Each point represents the average of six gums and the error is given as 1 S.D. Key: distance between the chewing surfaces, 1.6 mm (diamonds) and 2.0 mm (squares).

similar using the default settings developed for Nicorette[®]. Fig. 7 shows the release of the active substances from two different formulations for motion sickness. In Fig. 8 the release of xylitol from a sugar free chewing gum is shown using two different settings of the distance between the chewing surfaces. Again, decreasing the distance increases the rate of xylitol release as seen above also for nicotine release from a Nicorette[®] chewing gum (Fig. 4).

Guidelines indicate that in vitro release equipment should mimic an in vivo release situation as closely as possible so that good in vitro/in vivo comparisons can be obtained. The possibility to influence the in vitro release by adjusting the different settings on the present chewing apparatus improve the odds of achieving such correlations. In Fig. 9, a chew-out study of the Nicorette[®] nicotine gum is overlaid on an in vitro release profile from the same type of gum where the settings have been tuned to mimic the results from the in vivo study. The two release curves are sufficiently similar to permit the use of the in vitro chewing as a model for the standardized in vivo

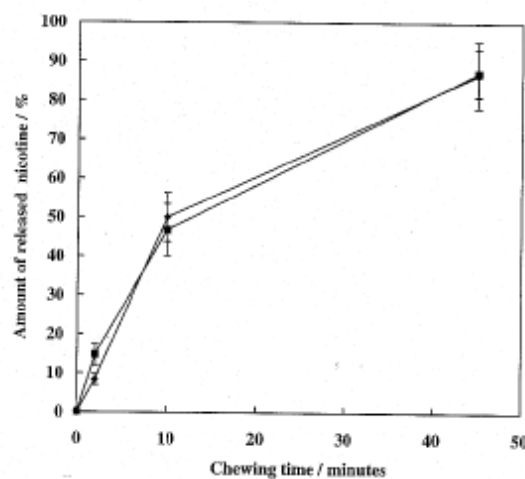

Fig. 9. Comparison of in vivo and in vitro release using Nicorette[®] 2 mg Classic (Pharmacia and Upjohn), expressed as percentage of label claim. Conditions: In vivo release, see Section 2.6. In vitro release, see Section 2.4 except for the following settings: stroke frequency, 30 stroke/min; distance between the chewing surfaces, 1.8 mm. Each point represents the average of six gums and the error is given as 1 S.D. Key: in vivo (squares), in vitro (diamonds).

situation. This could be useful during development of new products even if it should be kept in mind that major changes in the gum formulation can significantly jeopardize the original comparisons.

4. Conclusions

The present study has shown that the apparatus presented here, developed for in vitro release tests of medicated chewing gums, delivers satisfactory results for a number of varied gum formulations. The large freedom in the choice of instrumental settings provides a good basis for tuning the release profiles of individual formulations and for obtaining usable in vitro/in vivo correlations.

References

- Christrup, L.L., Möller, N., 1986. Chewing gum as a drug delivery system I. In vitro simulation of human mastication and influence of formulation upon the release rate of a water soluble drug. *Arch. Pharm. Chem. Sci. Ed.* 14, 30–36.
- Cantor, E.D., 1981. Guidelines for dissolution testing of solid oral products. *Pharm. Ind.* 43, 334–343.
- Gray, V.A., Grady, L.T., 1997. USP Dissolution standards — Revisions, initiatives and new policies since 1980. *Pharm. Forum* 23, 4183–4197.
- Kleber, C.J., Schimmele, R.G., Putt, M.S., Muhler, J.C., 1981. A mastication device designed for evaluation of chewing gums. *J. Dent. Res.* 60, 109.
- Liljewall, L.R., 1989. Methods and apparatus for mechanical processing of a sample and a member of such an apparatus. PCT Patent WO 89/05970.
- Liljewall, L.R., 1992. Methods and apparatus for mechanical processing of a sample and a member of such an apparatus. United States Patent 5 087 424.
- Nemeth-Coslett, R., Benowitz, N.L., Robinson, N., Henningfield, J.E., 1988. Nicotine gum: Chew rate, subjective effects and plasma nicotine. *Pharm. Biochem. Beh.* 29, 747–751.
- Rassing, M.R., 1996. Specialized oral mucosal drug delivery systems: Chewing gums. In: Rathbone, M.J. (Ed.), *Oral Mucosal Drug Delivery*. Marcel Dekker, New York, pp. 319–357.
- Rider, J.N., et al., 1992. Development and Evaluation of a novel dissolution apparatus for medicated chewing gum products. *Pharm. Res.* 9, 255–259.
- Siewert, E.D., 1995. FIP guidelines for dissolution testing of solid oral products. *Drugs Germany* 38, 50–61.
- Woodford, D.W., Lesko, L.J., 1981. Relative bioavailability of aspirin gum. *J. Pharm. Sci.* 70, 1341–1343.