



# Handbook for Energy Communities

This handbook has been prepared by a working group established under the Energy Forum South Harbour. Energy Forum South Harbour was funded by the Danish Energy Agency in the years 2017-2019, through a programme aimed at “Local partnerships furthering energy efficiency and flexible consumption”. The working group consisted of: Ulrik Jørgensen and Morten Elle, Department for Planning, Aalborg University; Diana Lauritsen and Øystein Leonardsen, Urban Renewal Office South Harbour; Ann Viksø, Kgs. Enghave Local Committee; Flemming Gerhardt Nielsen, Faculty of Law at the University of Copenhagen; and John Kepny-Rasmussen, Copenhagen Social Housing (KAB).

The work has been carried out with contributions from COWI A/S, who has drawn up the Technical Catalogue in Appendix A and EBO Consult A/S, who has been instrumental in analysing organization and enterprise models, as well as the model articles of association in Appendix B.

This handbook is aimed at professionals and stakeholders from housing societies, municipalities, shops and small businesses, who wish to explore their options of establishing energy communities. It further provides an overview of the new opportunities which authorities and utility companies have, as they implement the

new EU directives on Renewable Energy and the Electricity Market. In order to fully realize the positive contributions which energy communities can make to a sustainable transformation of the integrated Danish energy system, the design of this legislative and administrative framework is of great importance.

To support its mission of creating more energy-efficient local solutions, Energy Forum South Harbour has worked with civic co-creation and strengthening of existing communities, building on projects and learnings from the old borough of South Harbour. Energy Forum South Harbour is a partnership between the South Harbour Urban Renewal office, the Climate Secretariat in Copenhagen Municipality, Kgs. Enghave Local Committee and the Institute for Planning at the University of Aalborg.

The Handbook has drawn on Danish energy legislation and history which emphasize the characteristic that grids and several utilities are owned by municipalities, public companies or cooperatives.

For more information:

- Ulrik Jørgensen, email: [ulrik@uj-consult.dk](mailto:ulrik@uj-consult.dk)
- Øystein Leonardsen, email: [oysleo@kk.dk](mailto:oysleo@kk.dk)

**Introduction - purpose and structure of the handbook 6**

The handbook's purpose and target audience .....	7
Structure of the handbook .....	7

**What is an energy community? 8**

A new actor in the energy system .....	8
Focus on locally based energy communities .....	10
The eu definitions of energy communities.....	11

**Challenges to the transformation of the Danish energy systems 14**

The traditional, collective energy supply .....	14
From central cogeneration plants to a diverse energy production.....	16
The next, critical phase of the energy transition .....	18

**Components of the Energy Community and their respective contributions 20**

The partners' benefits from and contributions to the community.....	21
Establishing renewable energy installations.....	22
Electrification of heating supply and transportation.....	24
Excess heat utilisation.....	25
Contributions to the danish energy transition .....	25

**Interactions of energy communities with energy supply and infrastructure 26**

Partners and objectives .....	26
A new actor in the energy system .....	27
Principles for participation in an energy community .....	28
Tasks of the energy community.....	29
The different motivations of the partners .....	30
Energy communities in company law .....	31
Cooperative or association?.....	32

**Interactions of energy communities with energy supply and infrastructure 36**

Variable prices of electricity and heating.....	36
Use of the common grids .....	37
Other 'new' actors – in particular in the electricity market.....	39
Duties paid to the state and their purpose .....	42
Opportunities to carry out experiments .....	43

**Action plan to establish an energy community 44****Appendix A: Technology Catalogue 46**

1. Use of existing grids and meters in the energy community .....	47
2. Solar pv connected to local consumption.....	51
3. Local pv production and storage for flexibility.....	59
4. Heat pumps with local energy sources - general information .....	65
A. Source: geothermal.....	71
B. Source: lake/sea water.....	78
C. Source: air .....	84
D. Source: roof surfaces .....	88
5. Buffer heat tanks for smoothing peak loads .....	92
6. Combination of electricity based transport and use of batteries for flexibility .....	98
7. Combined shop cooling and heat recovery .....	105
8. Additional electricity heating of domestic hot water .....	110
9. Solar heat added to the heating system .....	114

**Appendix B: Proposals for standard statutes 119**

Statute for an association .....	120
Statute for a cooperative.....	128

## 6 Introduction

### - purpose and structure of the handbook

In the coming decades, Denmark faces a major task in transforming its energy system. A radical transformation is necessary, as the country transitions from covering 50% to 100% of its electricity consumption through renewable energy sources such as solar and wind. Simultaneously, district heating suppliers must cease their use of fossil fuels and substantially reduce the use of biomass, and the transport sector must be electrified and/or switch to bio-based fuels. This shift necessitates the integration of the energy system as a whole, and an end to the historical fragmentation of the electricity, heating and gas sectors. A closer integration of the electric and heating sections of the energy supply, with, for example, the conversion of electricity into heat through heat pumps, is thus a key element in the transition.

In the next few decades, the transition from fossil to renewable energy sources will radically change the Danish energy supply, where development so far has largely consisted of adding

new, smaller production units (in the form of wind turbines and small CHP plants) to the existing structure of large central cogeneration plants. The transition to renewables is crucial in allowing Denmark to meet the political objective of a 70% reduction in CO<sub>2</sub> emissions by 2030, and this in turn requires an acceleration of the energy system transformation.

Local energy solutions are well placed to ensure the integration of electricity and heating. Therefore, local energy solutions must contribute to, and complement, the transformations to be made in the production of electricity and heat at regional and national level.

In this context, the EU's new energy directives play a major role in defining the framework for local energy solutions in the form of energy communities, also known as renewable energy cooperatives. This framework must be implemented in Danish legislation in the course of 2020 and spring 2021, which will be crucial for the further energy transition in Denmark.

### THE HANDBOOK'S PURPOSE AND TARGET AUDIENCE

The purpose of this handbook is to:

- Provide guidance to local actors in housing societies, municipalities, smaller businesses and shops, allowing them to create and operate energy communities.
- Contribute to ensuring that the new regulation prepared by the Danish government, along with the network tariffs and charges system set up by the utilities companies, supports the creation of energy communities.

The handbook consists of number of chapters, which introduce the concept of energy communities, explain how they may be established technically, legally and financially, and finally

suggest an action plan for setting up an energy community. The manual also includes an Appendix A, which describes the energy technology elements that an energy community may choose to complement their energy system. Further, Appendix B presents two sets of model articles of association for the legal and financial organization of an energy community. [energifællesskab](#).

*“Denmark faces a major transition, where local energy solutions are central”*

### STRUCTURE OF THE HANDBOOK

Section 2 introduces the energy community as a concept and outlines the importance of the new EU energy directives for their creation. Section 3 reviews how the transition of the Danish energy system to sustainability has evolved historically, and the issues that need to be addressed in the coming years. Section 4 goes into greater detail with the benefits which an energy community with a diverse set of partners can bring to both the partners themselves, and to the overall energy system.

Section 5 describes which parties are formally able to participate in an energy community, and how the community can be organized to best fulfil its purpose, and as a legal entity. Section 6 describes the interaction of energy communities with the overall energy system, represented by utility companies and infrastructure. Lastly, section 7 concludes by outlining a how-to guide for the establishment of an energy community.





Local energy communities will be an important complement to regional and international energy supply networks in the coming decades. They are capable of delivering renewable energy to the community, and promote energy savings while smoothing energy consumption and providing flexibility for the overall energy system. This will be an important complement to the regional and international supply networks which relay power from large energy producing installations such as wind and photovoltaic parks, hydropower, geothermal plants, waste incineration and cogeneration heat and power plants.

### A NEW ACTOR IN THE ENERGY SYSTEM

The Energy Community differs significantly from the consumers who today make up the energy system's customer side. At present, heating is supplied to each apartment building, institution or business, and they in turn might have meters for distribution between e.g. apartments/households. The electricity supply, on the other hand, provides the household, institution or business with meters for each individual customer.

Energy communities can be constructed from, and thus represent, different forms of collaborations. They might for instance focus on setting up a renewable electricity or heat-based production, combined with bringing together a number of distributed activities such as electric car charging stations, which may then be included in the provision of flexibility. In this way, several known forms of cooperatives, which

Here, the local, interconnected and flexible energy systems which combine own production of renewable energy, the conversion of energy from electricity into heat, and time-of-day and day-of-the-week consumption displacement are essential for achieving local energy savings, as well as for the efficiency and sustainability of the overall energy system. The idea of these new, local systems is the basis of the new entity: "The Energy Community". The energy community acts as the organizational construct which brings together a potentially diverse set of parties in a legal and economic entity,

together own small wind farms, photovoltaic parks, etc. might also in future be organized with reference to provisions regarding energy communities.

According to EU directives, an energy community is not required to consist of immediately neighboring actors cooperatively organizing their energy activities. It may well be, for example, a group of distributed energy consumers who together own and operate an electricity production through a wind turbine or photovoltaic park located nearby. An example of this type of energy community could be municipal buildings in a city, which together make up an energy community that drives photovoltaic installations and heat pumps for these properties. It could also be an Association of car-sharing users, who jointly run a park of electric cars and electric charging points.

## FOCUS ON LOCALLY BASED ENERGY COMMUNITIES

This handbook focuses on the energy communities whose core activities are linked to a local, coherent area. This is because energy communities can contribute to the overall energy transition through the creation of a renewables-based production, storage and conversion system in their local energy system, because of their access to property and land for this purpose. At the same time, this type of energy community could minimize the need to add new network capacity and reduce network losses, which today represent a significant cost for both electricity and heat suppliers. We have thus chosen to focus on this kind of energy communities because they can, in a completely new way, contribute to the overall energy transition. They can make use of local opportunities to finance and build renewable energy-, storage- and conversion installations, which require local stakeholders' active participation and ownership in terms of both land, buildings and installations. This points to an opportunity for closely populated urban areas to contribute to the sustainable transformation by establishing energy communities. Further, this kind of energy community may also be taken up by an eco-village or by a rural village community.

*“Local energy communities are the focus of this report”*

The objectives of the locally coherent energy communities are to:

- ensure energy savings, which can be achieved through reduced consumption and increased energy efficiency in buildings and appliances;
- optimize heating as an interplay between the operation of boiler rooms and buildings by ensuring continuously optimized operations;

- provide for the establishment and operation of own production of electricity based on renewable energy sources and heat from heat pumps, leading to local production, only to pay network tariffs that correspond to the costs of the local network, as long as it is consumed within the community and providing lower requirements for the capacity of the network
- allow consumption management across the time of day and -week through storage, in order to avoid peak times, making it possible to provide “flexibility” to the grid and use periods of low prices for the purchase of electricity and heat.

The following figure illustrates the energy-technologies and local activities which can be part of an energy community, and how they are interconnected in an electricity- and a heating network, respectively. Energy production stems from solar panels and, potentially, wind turbines. The conversion takes place in heat pumps and in the form of surplus heating, while storage can take place in heat tanks, electric vehicles and potentially batteries.

Figure 1 shows the parties who can be part of an energy community, as well as their role as consumers and/or producers. It further shows the linkages that make the integration and smoothing of consumption possible, through the community's governance of the local energy system in relation to the larger supply grid. The energy networks shown are illustrated in the figure as ‘virtual networks’, as they can continue to be owned and maintained by utilities, or may be owned by the Energy Community, if necessary. Here, they would simultaneously contribute to both the community's internal exchanges of electricity and heating, and to the transport of energy between the community and the surrounding utility grids and -companies.

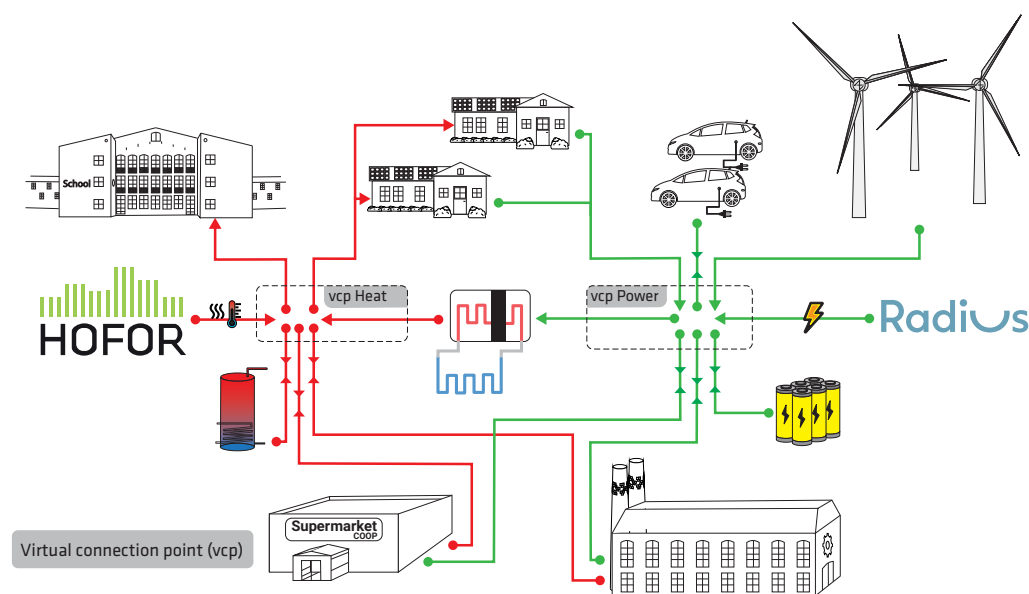

Figure 1: Illustration of a local energy community comprising of housing, institutions, companies and means of transportation, that produce energy themselves and at the same time are connected to the common grid through local (virtual) grids (in case illustrated by the Copenhagen supply companies HOFOR and Radius).

## THE EU DEFINITIONS OF ENERGY COMMUNITIES

Although the EU does not focus on heating supply, the new directives for electricity markets and for the promotion of renewable energy in Europe are crucial for the energy transition. The directives must be implemented into Danish law in the course of 2020 and the first half of 2021, and their implementation is vital not least to realize the opportunities for local contribution to the energy transition. In order to promote citizens' influence on the transition, and to ensure the expansion of renewable energy, the EU is actively engaging in future energy regulation with provisions that define the rights of consumers (customers) to produce, store, consume and sell energy themselves; both as relates to renewable energy specifically and electricity in general.

The energy policy objective of legislating on citizens' rights and in this context to establish new actors in the field of energy is to promote the sustainable and fossil-free transformation of energy systems, as demonstrated in the following: “Member States shall ensure that their competent authorities at national, regional and local level include provisions for the integration and deployment of renewable energy, including for renewables self-consumption and renewable energy communities, and the use of unavoidable waste heat and cold when planning, including early spatial planning, designing, building and renovating urban infrastructure, industrial, commercial or residential areas...” (Renewable Energy Directive 2018/2001, Art.15, 3)

This is further supported by the directives' criticism of obstacles to citizens' participation in the energy transition, as exemplified in the following statement: 'However, legal and commercial barriers exist, including, for example, disproportionate fees for internally consumed electricity, obligations to feed self-generated electricity to the energy system, and administrative burdens, such as the need for consumers who self-generate electricity and sell it to the system to comply with the requirements for suppliers, etc.' (Electricity Market Directive 2019/944, Preamble, 42).

This support for the involvement and empowerment of citizens in the development of renewable energy and in the energy-supply has taken place through the definition of these rights for individual consumers (using the terms 'renewables self-consumers' and 'active customers'). Further, in the form of a new legal and economic entity: energy communities (with the terms 'renewable energy communities' and 'citizen energy communities'), which are a legal and economic cooperation between consumers (including housing societies), municipalities and small businesses (including shops).

The option to set up these types of energy communities is the result of 3 years of work in the EU with the two new energy directives, a good deal of negotiation between the EU institutions, as well as consultations with many stakeholders. The result is that, for the first time in EU law, a regulation has been set up which provides citizens who organize in communities regulated access to the energy market for all EU countries, as both producers, distributors and consumers.

Energy communities are awarded a central role by the EU, as a way of involving consumers in the development of renewable energy and the transformation of the energy sector: 'Community energy offers an inclusive option for all consumers to have a direct stake in producing, con-

suming or sharing energy. Community energy initiatives focus primarily on providing affordable energy of a specific kind, such as renewable energy, for their members or shareholders rather than on prioritizing profit-making like a traditional electricity undertaking.' (Electricity Market Directive 2019/944, Preamble, 43).

Some differences remain in the function and role of 'citizens communities' (Electricity Market Directive 2019/944, Art.2 and Art.15) and the 'renewable energy communities' (Renewable Energy Directive 2018/2001, Art.2 and Art.16). This is because the Electricity Market Directive is based on the idea that competition based market solutions based will help to make energy systems more efficient within and across borders, while the Renewable Energy Directive builds on a desire to promote renewable energy and build on the experience of collective bargaining as instrumental in promoting the transformation of the collective energy supply. The differences may lead, in some situations, to different results, and thus an ambivalent regulation. They arose as the big electricity companies, in particular, played a major role in the final version of the Electricity Market Directive, while the organizations representing cooperative renewables-based installations in particular focused on the Renewable Energy Directive. The citizen energy community has activities in all sectors of the electricity market, while the renewables energy community has only renewable energy activities. In practice, energy communities will not realize their full potential as contributors to the sustainable transformation of energy systems, unless they are considered jointly, rather than as two separate types of communities.

The key aspects of the establishment of energy communities will be further elaborated and explained in the following sections of the Handbook.

# 14 Challenges to the transformation of the Danish energy systems

This section outlines the ongoing transformation of the Danish energy systems in order to provide the handbook's users with a better understanding of the transition process and the contribution that energy communities can make to the transformation.

## THE TRADITIONAL, COLLECTIVE ENERGY SUPPLY

The Danish energy supply has been dominated for half a century by the supply of large combined heat and power (CHP) plants, producing both electricity and heat. The subsequent distribution of heat and electricity is then carried out through separate collective grids to end users, which range from individual households to institutions and businesses. Following the oil crisis in the 1970s, this system was supplemented by new electricity production from wind turbines, and by a nationwide transmission and distribution network for natural gas, which at the time worked mainly as a replacement for the oil which still played a major role outside district heated areas.

This way to structure the supply of electricity and heating has clearly defined divisions of labour between CHP plants and wind farms on the one hand, responsible for the production of electricity and heating, and on the other hand an extensive network for distributing electricity, district heating and natural gas to end users. This energy system design, based on a central supply of electricity and heating, has become increasingly dominant. Smaller CHP plants are now replacing individual oil and gas boilers in the heating supply, as district heating is established in both smaller cities and suburbs to the larger cities.

The design is illustrated in Figure 2, with a detached house as consumer. This shows how energy production is coordinated, while distribution is divided, with the various forms of energy only meeting again at point of consumption.

The section will, amongst other things, explain why new actors are needed in the energy systems and why the integration of electricity and heating will be crucial in the coming years.

The single-family house in the illustration could be replaced by a apartment block, a public institution or a private manufacturing or trading company.

Denmark has been a pioneer in many ways when it comes to the involvement of citizens in setting up collective solutions for joint energy supply. It has provided citizens with the opportunity to engage with the energy system as both producers and distributors, either through municipalities or by direct ownership through cooperatives etc. This has been supported by a tradition of solving local tasks by allowing groups of citizens to share both costs and revenues of establishing local utilities, as well as government support for the legal access to do so. The expansion of wind turbine production in the 1970s and 1980s was to a large extent driven by citizen cooperatives investing in wind farms.

In the municipal sector, a number of supply tasks have been performed for decades in accordance with the 'municipal authority', unwritten rules on the remit of the municipalities. Here, municipalities have had the opportunity to carry out local supply activities, provided they comply with a principle of community equity, meaning amongst other things, that equal grid access must be guaranteed for all citizens. In this way, municipalities have been able to secure the supply of utilities through private legal entities, such as cooperatives, as long as these companies have followed the principle of equality vis-à-vis

stakeholders in their business. In concrete terms, this means equal grid access and pricing terms for all. Water and district heating companies have typically been organized under private law, where the municipalities have been able to actively promote citizens' desire to supply themselves. Since the late 1970s, the supply of electricity, heating and natural gas has been regulated by specific legislation built on these principles.

The long-standing local cooperation between public and private organizations has shaped the

development of the various public utility sectors, and provides the basis for much of the local utility structure we see today. Thus, it should be noted that the public sector has historically been actively involved in supporting the development of a local energy supply controlled by consumers/local citizens. This is unique when compared with other countries in Europe, which have a tradition of private ownership of energy production and distribution companies (Concito 2016; Annual Environmental Strategic Meeting 2017).

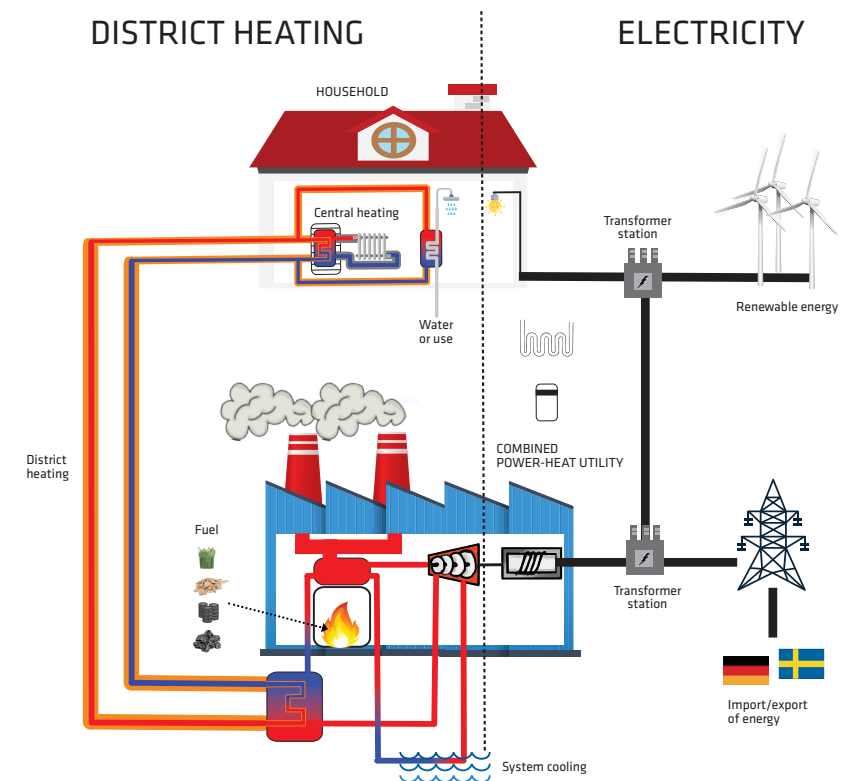

Figure 2: The Danish supply model based on cogeneration heat and power utilities, distribution companies and customers (in case shown as a single-family house, but could as well have been a tenant building or a larger company)



At the same time as the widespread support and involvement of citizens in collective supply solutions, they have followed the pattern of technology and governance (overall, the 'energy regime') described above with central supply

### FROM CENTRAL COGENERATION PLANTS TO A DIVERSE ENERGY PRODUCTION

The growing contribution of electricity generation from wind-turbines has led to a slow shift from larger power plants being in charge of electricity generation, to the fact that today is around 50 % of electricity consumption currently supplied to the electricity grid from wind turbines and wind farms. In 1980 it was politically agreed that

units, collective supply grids and customers who in most cases received the energy from suppliers, while self-production has been rare (when not taken into account the use of fossil fuels for heating by oil-, gas- or biomass burners).

all multiple heat plants should be converted into decentralized, cogeneration units on natural gas. Local, smaller heat and power plants have been set up to spread the benefits of multiple heat, together with electricity. From a centralized energy system based on large utilities, nowadays energy system based on large works is widely distributed, as shown in Figure 3.

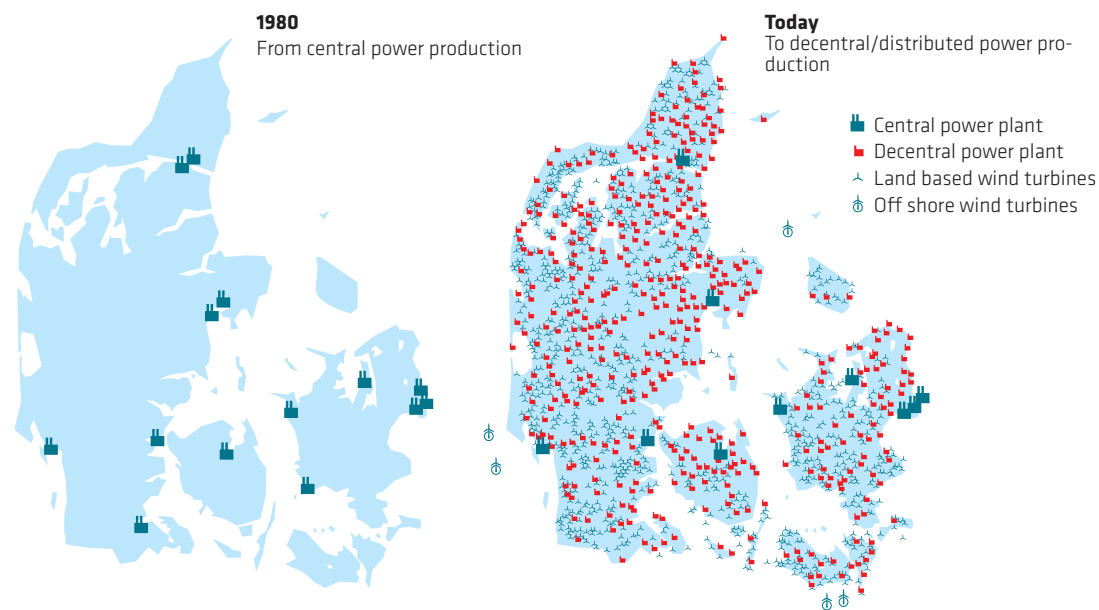

Figure 3: The development of generation of large CHP plants in 1980 into a much more complex system today, where windmills and local combined heat and power plants have radically changed production.

While electricity and heat supply undertakings were already based in their starting point on the desire of civil society to play an active role in the development of an efficient energy label, this model has been developed with the construction of wind and photovoltaic, often with a local starting point. Most of these civic organizations have idealistic and economic objectives that are reflected in the purpose of the ticks. The organization of this known form of local "energy communities" has been included as part of Danish legislation, as can be seen, for example, in the Danish Act on the Promotion of Renewable Energy §21, 2, where the following state guarantees for the costs of the initial benefits in value are of a renewable energy project:

*The granting of the guarantee shall be conditional upon the following fulfilment of the following conditions at the time of the entry of the claim and the lodging of the guarantee:*

- 1) *The wind turbine, the solar panels or the initiative group has at least ten participants.*
- 2) *The majority of the wind turbines and solar cell cooperatives or participants of initiative groups are residence registered in the CPR with an address in the municipality where the mill or photovoltaic installation is planned to be set up or outside the*

*municipality at a distance of no more than 4.5 km from the location where the mill or photovoltaic installation is planned to be installed. In the case of wind turbines established outside the scope of the invitation to tender, the place of residence according to point 1 must be in a municipality which has a coastline within 16 km of the location of the location. (Act No 356 of 4 April 2019, as amended).*

This provision reflects the Danish State's acceptance of, and support for, the conclusion that citizens can join together on the creation of energy supply activities, and that the State is encouraging that this is done in a way that is closer to specified conditions like the location or influence by local citizens. The interaction between civil society and civil society to promote energy supply is an important factor in the formation of local energy communities.

In addition, an extension of solar cells to the production of electricity and the conversion of electricity into heat of heat pumps is an increasingly important part of the household. It has added new local components to the energy system and has started a development where supply companies are no longer solely responsible for all electricity and heat distribution and production, which has been further decentralized.

*"Cooperatives have played an important role in the development of renewable energy"*

## THE NEXT, CRITICAL PHASE OF THE ENERGY TRANSITION

Overall, along with the new EU directives, this development leads to a radical disruption of the energy system in Denmark. It points towards an overall transformation of the dominant, traditional energy regime, which is reflected in the existing Danish legislation on energy and utilities. The current developments therefore require both structural and regulatory changes, which support increased integration of the overall energy system. In particular, by allowing for a number of new opportunities and tasks related to connecting the energy system at the local level, both through energy communities and through the new roles that individual consumers can take on, covered by the term 'prosumers' (which stands for: producing consumers).

A key challenge for the future collective energy system is to establish flexibility in the exploitation of the electricity produced. The increasing volume of electrical power consumption over the coming decades will significantly increase dependence on wind and solar. This will happen as, simultaneously, the large CHP plants

gradually decrease in performance efficiency and economic viability. Here, the switch to less CO2 emitting fuels such as wood pellets work only as a transitional solution, especially as the consumption of these fuels has grown rapidly and is unsustainable.

Establishing flexibility will require a combination of new solutions. In terms of heating, it will involve building renovations, better use of surplus heating, electrification of heating production through e.g. heat pumps, and the contribution from new types of heat generating geothermal plants.

Overall, this means that the existing energy systems structure, and the regulation underpinning it, must be redefined in terms of both their technical, legal and economic organization. In other words, the energy transition is not only a question of new technologies, but is greatly reliant on changing the roles of citizens, businesses, municipalities, utilities, and the state, as well as their ways of working together.

*"Integration of power and district heating systems are crucial in the future"*

*"To make the transition successful, we must invent new forms of cooperation"*

# 20 Components of the Energy Community and their respective contributions

The Energy Community, as introduced and described in the section “What is an energy community?”, ideally consists of four components. Together, these create value both in terms of local community building, for each of the involved partners and users of the energy, and by reducing adverse impacts on the climate. The four components are: (1) the organizational and activity framework that the Community and cooperation provides, (2) the participating parties and their contributions in terms of land and investment, as well as benefits in terms of energy supply and increased comfort; (3) the new renewable energy technical installations; and (4) cooperation with,

and services to, the collective energy grids and suppliers.

*“There may be an advantage to have many different types of partners in an energy com-*

The following sub-sections will go through the contributions of the different partners, the common renewable energy technical installations and the contributions to the overall energy system.

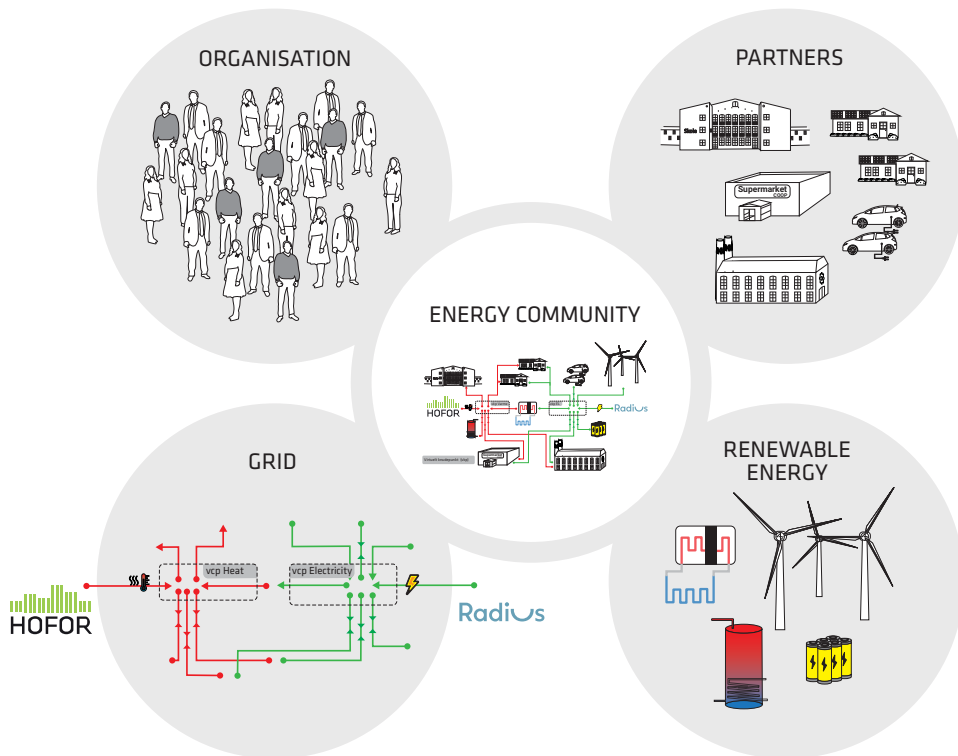

## THE PARTNERS' BENEFITS FROM AND CONTRIBUTIONS TO THE COMMUNITY

The community partners, and the users that they represent, mainly benefit from the community's work through increased comfort of their homes and institutions, as well as the reduction in overall energy costs. This reduction stems from multiple sources, where different partners contribute separately and collectively:

- the optimization of heating systems, electricity usage and building exteriors;
- the own production of energy through solar panels and its use in e.g. heat pumps;
- potential participation in larger scale renewable energy installations “nearby”
- the management of the joint facilities to avoid peak consumption;
- efficient use of the grid capacity;
- potential use of waste heat and -cooling from shops, institutions and small businesses;
- potential supply of electricity to electric vehicles and utilization of their battery storage
- lower network tariffs due to economies of scale and less transport of energy in and out of the community's grid area.

An energy community may include a number of different partners who wish to engage in this cooperation. The rules governing this will be detailed in the following section 5. They may include housing societies, public institutions, shops and small businesses. By seeking broad cooperation, better energy efficiency may be achieved by combining the different consumption patterns of the partners in the course of the day, the week and the year. Thus, composing energy communities of partners with different consumption profiles and capacity to contribute to load displacement, is an essential component in creating local energy systems which can contribute to the overall energy transition, but also to limiting the need for building new grid capacity. The differences in consumption consist, amongst other things, of variations in the peak consumption periods as can be seen for heating and electricity in figure 4.

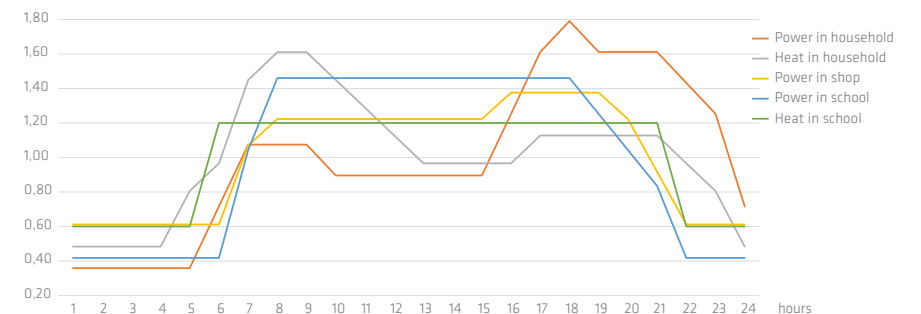

Figure 4: Day-based graphs (normalized) for typical household consumption of power and heat, as well as public institutions and shops consumption of power and heat showing peak load periods.

The delimitation of the Energy Community by the type of participating partners implies, in addition to the ideal objectives of developing a meaningful local community and contribution to

the fight against climate change, the following benefits and disadvantages for the functioning of the community:

PARTNERS	CONTRIBUTION TO THE COMMUNITY	OUTCOME OF THE COMMUNITY
Housing department and other housing units	Roof space for solar PVs and e.g. ground space for the installation of vertical sources for heat pumps Energy optimization of buildings and energy usage	Lower prices on power and heat Access to electric cars Basis for investments in renewable energy installations
School, kindergarden, library	Contribution to a different consumption profile E.g. contribution of surplus heat	Lower prices on power, heat and cooling Options for local electric cars for common use
Shopping center, small businesses	Contributing with alternative consumption profile Utilization of surplus heat and cooling	Lower prices on power and cooling Increased local attention
Charging of electric cars and bicycles	Contribution with load shifted consumption through storage	Cheaper power and improved management
Partnership in wind turbines	Extended self production	Basis for investments in renewable energy installations

There are therefore good reasons for seeking a wider composition of an energy community, as it increases its potential to function as an

effective part of the overall transformation of the total, collective energy system.

## ESTABLISHING RENEWABLE ENERGY INSTALLATIONS

In addition to energy savings and more efficient use of energy, the main contribution an energy community can make is invest in the expansion of renewable energy installations. For local energy communities in urban areas, this can typically consist of solar panels which utilize existing

rooftops. Beyond this, it may be through supporting or acquiring shares in e.g. wind turbines located within or in the vicinity of the community territory, which the energy community can draw on without taking up grid capacity across greater distances.

The capacity of solar cells to deliver energy is largely determined by the available rooftops amongst the energy community partners. Here, housing blocks and municipal institutions can often contribute with considerable capacity. It is even possible, through special arrangements, to gain access to rooftops of municipal institutions who are not themselves partners in the energy community (according to the Renewable Energy Directive). Photovoltaic technology is described in point 2 of the Technology Catalogue on "Solar cells coupled with local electricity consumption".

The dimensions of the photovoltaic installation is determined by the scale of investments which the Energy Community wishes to carry out, as well as how much electricity from solar cells it makes sense to supply for own consumption on a typical day. This need is determined by how much electricity Community partners are continuously consuming, how much electricity it is appropriate to convert to heating, and whether electricity is used to e.g. charge cars and bicycles. The excess electricity generated by the solar cells can be sold to the collective electricity grid.

There is also the possibility to store smaller quantities of electricity in batteries. This is most relevant to offset short term peaks in consumption and production, as batteries used only for the storage of electricity are a very costly way to store energy. This option is described in more detail in point 3 of the Technology Catalogue's point 3 on 'Local electricity production and storage for flexibility'. The storage of electricity in e.g. the batteries of electric cars is a possible alternative, if the charging of electric vehicles is part of the energy community's activities. It is described in more detail in the following section.

While solar cells have a substantial part of their production outside of the 3-4 winter months, the advantage of having access to electricity production from wind turbines is that they have a more even production throughout the year. If an energy community is allowed

to participate in wind power plants, the total capacity should be aligned with this. The choice of capacity should be guided by a concrete and comprehensive analysis of the total energy needs and investment abilities of the energy community, and is therefore specific to each energy community.

A very central component of the energy community is the data collection and management of electricity production, the conversion of electricity for heat, the possible utilization of waste heat, the storage and consumption of electricity and heat from own facilities, and from the collective supplies of electricity and heat which are available to the community. In

*"Data collection and smart governance are central to an energy community"*

this way, the Energy Community will be able to optimize the operation of its own facilities and the consumption of external supplies so that, as a whole, it uses energy when it is the cheapest and most efficient to produce. Thus, apart from being based on renewables as far as possible, the Energy Community's use of energy is also optimized in terms of energy efficiency.

In this context, it is also important that there are clear agreements on the use of the collective grid by the Energy Community, as referred to in the previous subsection on "Focus on locally based energy communities" and further explained in the later subsection on "Usage of the collective supply grids". It also requires access to smart meters that can provide data on the partners' electricity and heat consumption, so that data collection and management can be achieved. Parts of this is also referred to in point 1 of the Technology Catalogue in Appendix A on "Use of existing energy grids and meters in the Energy Community".

## ELECTRIFICATION OF HEATING SUPPLY AND TRANSPORTATION

Electrification of the heating supply mainly consists of using electricity generated by solar cells to run heat pumps. Normally, heat pumps require access to a sizeable, flat area to feed the pump. However, in urban areas, it is also possible to use vertical drillings as source. If the energy community is located near a harbor or a lake, it may be possible to use the temperature in the water as feeding source. Heat pumps and their feeding sources are described further in point 4 of the Technology Catalogue on “Heat pumps with local energy consumers” and the following four sub-points on: (a) geothermal heating;

(b) lake/sea water, (c) air and (d) rooftops, as feeding sources for heat pumps.

*“Energy communities can contribute to the electrification of heating and transportation”*

The advantage of using heat pumps is that they use the electricity generated much better than, for example, direct electric heating. This is because the heat pump produces heat energy in excess of the electricity it consumes. At the same time, heating is in itself much easier and cheaper to store than electricity. Firstly, buildings and the district heating grid alone are capable of shifting demand for heating for 2-5 hours. Secondly, heating can be stored in buffer tanks, as described further in point 5 of the Technology Catalogue on ‘Heating buffer tanks for peak shaving’.

Deciding the optimum capacity of heat pumps and heat buffer tanks for storage of heat must be based on a more detailed analysis, determined by the level of investment in heat pumps that the energy community wants to make, and how much power from solar cells it makes sense to convert into heating. The needed heat pump capacity is determined by the amount of heating that is continuously consumed by the energy community, how much of this production may be shifted in time according to when the heat pump is used, and the amount of heating it makes sense to store in buffer tanks. The surplus heating produced by heating pumps can be sold to the collective heating supply.

It may be beneficial for an energy community to also contribute to electrification of passenger and freight transport, by allowing electric vehicles to be charged inside the community area. These include cars, small goods vehicles for shops and small businesses, and cars related to municipal institutions. Firstly, the electrification of transportation is an important part of the total Danish energy transformation. Secondly, the management of when and how vehicles charge, as well as potential use of car batteries at peak load times, could contribute to overall energy efficiency and limit the need for capacity expansion in the electricity grid. Managing the charging of electric vehicles is described in detail in point 6 of the Technology Catalogue on “The combination of electric transportation and their batteries for flexibility”.

## EXCESS HEAT UTILISATION

Although access to integration of surplus heat and -cooling is not mentioned directly in the context of energy communities, collective heating and cooling operators are obliged to provide connections, just as they are for local renewable energy sources (Renewable Energy Directive (RED), Art.24). It is therefore sensible to consider surplus heat and cooling, as something that could integrate into the total community energy system. This energy can potentially replace other energy production, if it can be fed into the system with the right thermal quality.

Especially if there are shops and small businesses as partners in the Energy Community, it would be relevant to ensure the use of their surplus heating, e.g. from refrigeration equipment, in the community heating system. This option is described in point 7 of the Technology Catalogue on ‘Combined retail cooling and heating capture’. The heating contribution of this type of plant can be quite significant, and its use is relatively low cost once the energy community has established the necessary installations and energy management systems.

## CONTRIBUTIONS TO THE DANISH ENERGY TRANSITION

First and foremost, energy communities contribute by increasing the amount of renewable energy in the overall energy system. The Energy Community’s focus on energy as a shared resource supports continual efforts related to energy efficiency and energy savings.

A local energy community is able to deliver flexibility to the collective system, through timing and managing its production, conversion and partly also consumption of energy. This will constitute an important complement to the regional and international supply networks and the major energy producing entities. The flexibility is based on reducing demand for electricity and heating during peak load times and, as a

consequence, also reduce the need to add capacity to collective supply networks at both local and at regional level. The functional contribution of peak load shaving is that the energy community can avoid purchasing electricity and heating in periods with high energy prices. It is also possible that energy communities can contribute to the provision of flexibility at times when this service is demanded outside the community’s local area. Here, the local, interconnected and flexible energy systems which combine own production with conversion and load-shifting, are crucial for the efficiency and sustainability of the overall energy system.



An energy community is a legal entity which constitutes a cooperation between different partners, as described in the previous section. These will be partners who have actively chosen

### PARTNERS AND OBJECTIVES

Partners in the energy community can be individuals, homeowners, Cooperatives, public institutions, shops and small businesses. They are all characterized by being energy consumers who choose to partake in a community in order to achieve greater benefits through this. Which entities are allowed to be partners in a specific energy community is determined by its legal construction, and the rules on participation laid down in the statutes of the community. The energy community's partners can each contribute their energy installations, and they can invest in and operate energy installations under the umbrella of the joint venture.

The Electricity Market Directive opens the possibility for a subsidiary of e.g. network companies to be a partner in a civic energy community (Electricity Market Directive, preamble pt.44). For an energy community, it may be advantageous that a major energy company involves a subsidiary, because they have technical expertise and a thorough knowledge of energy sector regulation. In addition, energy companies may participate financially in concrete projects, either as a participant in an energy community, in compliance with the provisions of the directives, or as a cooperating party in the construction of major technical installations. Here, the Energy Company and the Energy Community each construct their share of the technical installations, which can then be operated jointly.

to collaborate around joint investments and the operation of energy installations, and who may produce energy to supplement self-consumption, as well as possibly sell to others.

The participation of an energy company is not a necessity, and there may be benefits to energy communities instead working as clearly defined and delineated actors, in relation to energy-producing companies or electricity dealers, and in relation to companies that operate the collective energy grids.

*"The benefits of being part of an energy community may be both environmental, economic and social"*

The objectives of energy communities, according to the EU Directives, are aimed at creating environmental, economic and/or social community advantages rather than purely economic gains. Thus, their basis and starting point differs from the purpose of commercial enterprises, whose objective is to generate profits for the owners (Renewable Energy Directive, Art.2 and Electricity Market Directive, Art.2). The special thing about energy communities is thus that their partners are all actively involved in and benefit from the community's activities. They have an intrinsic interest in these activities, as the energy community first and foremost produces energy for the partners themselves, rather than

working from a primary objective of producing something to be sold as a product to others. Interaction with the environment – the collective suppliers – happens primarily an exchange of services with them. These benefits for the community can be environmental, economic or social:

- The environmental impact stems from the climate impact of energy savings through improvements to energy installations, reduced energy waste, or conversion from fossil fuels to renewable energy, thus reducing CO<sub>2</sub> emissions.
- Economic benefits may be directly through energy cost savings due to joint activities and

### A NEW ACTOR IN THE ENERGY SYSTEM

The Energy Community differs significantly from the consumers who currently make up the energy system's customer side. At present, the individual housing property, institution or business is supplied with heating, and then has meters for distribution between, for example, apartments/households. The electricity supply, on the other hand, provides the household, institution or business with meters for each individual customer.

Energy communities can be constructed in various ways, and thus represent different forms of collaborations. They could for instance focus purely on establishing new production of renewable energy for electricity or heating, perhaps including distributed activities such as recharging points for electric cars which could be incorporated in the provision of flexibility. In this sense, a number of already known forms

lower energy prices for citizens, shops, public institutions and small businesses, and indirect by creating jobs for local craftsmen, or channeling profits towards establishing local businesses such as socio-economic enterprises.

- The social advantages of the community must be understood in a broad sense and cover, for example, local community building and empowerment through the participation of different citizens, and the creation of social relations.

of cooperative organizations which own small wind farms, photovoltaic installations, etc. could in future also be organized with reference to provisions on energy communities.

According to the EU directives, an energy community is not bound to be established within a coherent area with a local organization of energy activities, but may as well be e.g. a group of distributed energy consumers who together own and operate electricity production through a wind turbine or photovoltaic park located nearby. Examples of these energy communities could be all municipal properties, which together formed an energy community that operates photovoltaic installations and heat pumps for these properties. It could also be an association of car-sharing users, who jointly operate a fleet of electric cars and an electric charging point grid.

## PRINCIPLES FOR PARTICIPATION IN AN ENERGY COMMUNITY

The liberal market approach, which permeates the EU Directives, has led to the idea that participation in an energy community must be open and voluntary (Renewable Energy Directive, Art.2 and Electricity Market Directive, Art.2). It also supports the democratic dimension of energy communities. This means that the community statutes must include clear rules for the admission of new partners, as well as make it possible for a partner to withdraw from the community. In practice, this further necessitates that the energy community statutes include rules on how a new partner can contribute to the financing and further development of the common energy installations, as well as rules on the financial commitments and rights of a partner upon termination of community membership. These sides of the partnership mean that new partners must adhere to the existing objectives and activities of the energy community. It limits who can be and apply for admission as a partner in a specific energy community, as it is not simply a question of being a customer in a market-based relationship.

If the energy community is delineated as keeping its activities within a specific local area,

new partners must be associated with this neighbourhood, and be able to contribute to these particular types of activity. There is no requirement for physical proximity in the directives, with the exception of the indication that an energy community is able to own and operate a renewable energy installation in the vicinity of the community. Despite that, this handbook is particularly interested in the context of coherent and area-based energy communities, as they offer some special advantages both for the community and the surrounding collective energy system. Although the nearness-principle is not formally defined, it is already known in Danish law – and from a number of other Member States – where only persons and institutions living or located within a certain distance of the renewable energy project can participate in the project (Danish Act on the Promotion of Renewable Energy, § 15).

In the case of a more distributed community with a limited purpose, e.g. the organization of electrified transport, new partners must be able to meet the criteria for partnership/membership and adhere to the purpose of the activities organized around and by the Energy Community.

*"Energy communities with local proximity can own a renewable energy installation located not too far from the community"*

## TASKS OF THE ENERGY COMMUNITY

The decision-making competence in an energy community must lie with the partners, who must control all decisions taken in the joint community. This has been followed up so that e.g. subsidiaries of commercial companies are not permitted to have a decisive influence in an energy community.

The Renewable Energy Directive lays down requirements for the independence of energy communities. This implies that the Energy Community is not subject to external control and that the decision-makers formally involved should not be subject to instruction from persons other than those legally allowed to participate in the Energy Community. There is no equivalent in terms of clear rules in the Electricity Market Directive on citizen energy communities, apart from the restrictions above on the participation of subsidiaries and the general wording, that: "However, the decision-making powers within a citizen energy community should be limited to those members or shareholders that are not engaged in large-scale commercial activity and for which the energy sector does not constitute a primary area of economic activity." (Electricity Market Directive, Preamble, 44). An energy community must be able to organize, invest in, manage and exploit a local energy system, in cooperation with the surrounding regional and national supply networks. It thus requires a new and legally formalized form of organization, and represents a new form of content for the parties in the area of the neighbourhood, town, village or other type of community to organize around.

It is essential for the realization of common energy projects, that the energy community partners make agreements on how the projects' planning, pricing, role distribution, alternative options/plans, system design, expected production

of the system and management of operating experience with the system, servicing, and not least financing. Although not all of these elements must be included in the legal basis of the Energy Community organization, but can be included in agreements between the partners, the organizational framework of the Energy Community should strongly reflect the activities envisaged by the cooperation.

*"A local energy community requires a relationship built on trust between the parties"*

Thus, experience suggests that there is a big difference between establishing and operating a wind turbine as compared to, for example, the operation of a photovoltaic installation in combination with heat pumps. When the installation has the purpose of supplying a local area, where the different partners have different energy consumption profiles, this must be taken into account in shaping the organizational framework and describing the way the Energy Community intends to carry out its activities.

An energy community may choose to build their own expertise for the running of the day-to-day business. But just as it makes sense to pay for expert advice for projects outside the community, it also makes sense to consider paying for external services such as data management, ongoing optimization of the energy systems, and the operation of all the energy installations.

## THE DIFFERENT MOTIVATIONS OF THE PARTNERS

The partners of the Energy Community will have different motivations behind their participation in the establishment and operation of Community activities. Although they can all support both the idealistic and the practical objectives of the Energy Community, they will in their primary functions have completely different tasks and modes of management. They are so to speak a motley crew of partners working together to solve a common task with a common purpose. This should not be seen as a disadvantage, but rather an end in itself, which supports democratic processes and maintains local community engagements.

Establishing an energy community requires a relationship of trust between those who may be interested in founding the community in the local area. Lack of experience in working with local energy projects, and in particular how they are initiated, can be a barrier to the realization of an energy community. It requires insight, which can be drawn from this handbook and from similar projects in other urban areas. It may also be drawn from persons or organizations with specific knowledge of the specific project content.

Shops, small businesses, cooperative housing societies and private home owners typically have a close link between management, and decisions on investments and day-to-day operations. Or, in the case of a local branch, they are able to receive a decision-making mandate from top management. In e.g. social housing organizations and municipal institutions, decision making structures and engagement is distributed across several parallel forums and shared by representative, political and administrative leadership branches.

In the social housing sector, it is essential that coordinated support is established across the democratic bodies of the organization, and the administration established for the day-to-day management and operation of these housing units. Both sides of the organization must be

involved, and it may sometimes be necessary to overcome previous unfortunate experiences with other similar initiatives.

In addition, there may be regulatory barriers for local actors to participate in energy communities. In this context, one might refer e.g. to the Danish Act on social housing, which, in accordance with §6 of the Act, defines the purpose and the core areas of social housing societies. Participation in energy communities is not included in the definition of these core areas. However, paragraph 2 of the same provision creates an opening for participation in other activities, expressed as follows:

*In addition, the housing society may carry out activities which have a natural link to the homes and the administration thereof, or which are based on the knowledge acquired by the housing institution through its activities.*

On the basis of that provision, a Danish government order on Side Activities in social housing societies has been composed. This includes the participation of social housing organizations in energy supply services and the like. The guiding principle is that a social housing organization or division can own and operate heating-, water-, and cogeneration supply companies, electronic communications services and renewable electricity generation facilities. The prerequisite is that the number of customers external to the social housing organization is relatively limited. For electricity generating installations, it is further a requisite that the electricity must be delivered to the housing division or to the collective electricity grid, and a maximum limit for the supply of electricity has been set which corresponds to an installed power of 6 kWp (peak capacity) per residential and commercial unit. The housing organization or division may also contribute to and participate

in the management of the above-mentioned facilities, when they are external.

The 1998 Guidelines on Side Activities writes that there is no requirement as to the size of the deposit, or that the installation must be organized in a particular way. The management of the social housing society must however ensure, that the total involvement in the energy supply services is financially sound. In terms of the electricity generating module, it is worth noting that electricity can be supplied to the collective electricity grid from an installation established in a social housing division. There may be a need to clarify the side-activities of the housing organizations in some areas, adapting it to the energy targets for energy communities.

Municipalities will typically have a joint administration and operation of buildings and energy installations, cutting across individual types of

## ENERGY COMMUNITIES IN COMPANY LAW

In Denmark, many different types of legal structures are used for energy- and utility companies. This can be used as inspiration in choosing the company law form most suitable for the tasks and decisions to be handled by an energy community. A distinction is usually made between non-profit and for-profit organizations. The latter kind of company is intended to provide a financial gain for its participants, for example through lower energy prices or revenues from the sale of energy. The non-profit organization typically pursues more general objectives without financial profit for the participants.

In this context, the focus is on for-profit companies, where some companies are referred to as limited companies, i.e. shareholder companies and limited liability partnerships, while others are known as unlimited companies, where

administrative, social and educational institutions. This unit will carry out joint tasks and have established routines and policies for this operation, which local management and involved citizens have very little influence over. Here, it is necessary to establish an overall understanding inside the municipality's political and administrative organizations of what energy communities can contribute. This may then pave the way for the creation of open guidelines for a possible joint operation of buildings and energy installations, so that they can take part in the local community. This is specifically supported by EU directives, where municipalities are both listed as potential partners in an energy community and where, for example, municipalities and public authorities can make suitable roof surfaces available for photovoltaic cells, if the contribution of electricity is used in the local area.

at least one member has unlimited liability for the company's debts.

The unlimited partnership is an example of the latter kind of organization. In addition, there are other types of companies, such as cooperatives and partner companies.

There is thus much scope between the company types in relation to the legal position of the participants. In the typical limited companies, the legal status of the participants is regulated in several ways. This applies to a certain extent also to cooperatives, while there is typically contractual freedom in unlimited partnerships and associations with regard to the roles of participants (the Danish Commercial Companies Act).

In addition to the diversity of company law, there is also an economic regulation of some

companies. This is the case of electricity- and district heating companies, where a specific framework for company profits has been set. The profits of district heating companies are thus extensively regulated according to the so-called 'break-even' principle, in which income and expenditure must balance, which means that there is normally no return on capital in a district heating company (Danish Consolidation Act No 64, 2019, §202).

Around 340 of Denmark's roughly 400 district heating suppliers are organized as cooperatives, in which consumers are typically members. The co-op spirit of these district heating companies is visible in that members receive their heating at the lowest possible price, and thus the company acts in the financial interest of its members. In some electricity companies, which are organized as cooperatives, a part of annual profits is returned to its members in the same way as in the district heating company, while another part of the profits may be donated to non-profit purposes, e.g. financial support of activities for the benefit of the local community.

## COOPERATIVE OR ASSOCIATION?

The statutes of the cooperative or association must regulate all matters relating to decisions on investments, operation and settlement of the energy consumed (heat and electricity respectively) and, where applicable, the liquidation/withdrawal of a partner. This is because their purpose is non-commercial, and it must be decisive for the partners that their economic responsibility is limited (as opposed to e.g. the partnership) and their value is not, as e.g. in public limited companies being freely traded as shares.

Examples of standard statutes of these two forms of organizations and companies are outlined in Appendix B.

The choice of the legal form of the undertaking should in this context be determined by its ability to limit the liability of the participating parties, as well as ensure that the parties' participation in the energy community does not constitute an asset which may be valued and traded freely in a marketplace.

*"The cooperative and the association are the relevant forms of organization"*

With this in mind, an energy community may benefit from being established legally either as an association or a cooperative (with well-defined and limited liability), where the partners are either members or co-op shareholders – in both cases here denominated as partners.

The EU Directives do not demand certain types of company, but leave it to the Member States to decide which forms of company are to be accepted in the formation of an energy community. The Renewable Energy Directive states:

*Therefore, it should be possible for Member States to choose any form of entity for renewable energy communities, provided that such an entity may, acting in its own name, exercise rights and be subject to obligations. (RE Directive 2018/2001, Preamble, 71)*

while the Electricity Market Directive prescribes:

*It should therefore be possible for Member States to provide that citizen energy communities take any form of entity, for example that of an association, a cooperative, a partnership, a non-profit organization or a small or medium-sized enterprise, provided that the entity is entitled to exercise rights and be subject to obligations in its own name. (Electricity Market Directive 2019/944, Preamble, 44)*

Member States are required to actively promote the market maturity of renewable energy communities. In addition, both directives require that the Energy Community should not be prevented from acquiring registrations and/or licenses through undue, disproportionate or opaque procedures (RE Directive, Art.22, 4 and Electricity Market Directive, Art.16, 1)

One of the recommended legal forms, the cooperative, is well known from private cooperative housing and social housing, as well as from a number of co-op utility companies which have proved very successful over time. In its organizational structure, the cooperative includes all the principles required by the EU directives. With regard to the liability of the members of the cooperative, this should include working with limited liability.

Cooperatives are typically characterized by the equal position of the members (or partners) of the cooperative, allowing for optimal decision-making processes, where partners are heard consulted along the way and decisions are made on that basis. The cooperative can be structured in various ways, with its supreme authority as either a general assembly or a board of representatives. In the former case, all partners are able to participate in the general assembly, while the representative model assumes that various stakeholders appoint rep-

resentatives to the Board of Representatives, which then constitute the highest authority. Both models are known from energy utility companies.

The second recommended legal form, the association, is likewise a well-known way to be organized in Denmark. Also in this form, it is essential that the association is established with limited liability. As with the cooperative, the statutes of the association can contain the provisions which the EU Directives require for energy communities. associations have a less institutional character than a cooperative company and can therefore be regarded as a more "layman's" model of organization. The association is organized on the basis of the specific agreements between the members (the partners), and is thus more open and flexible to be specifically adapted to the tasks of the Energy Community than the cooperative form. But this also increases the need for precision in the clarification that must precede the concrete organizing of the association, and the writing of its statutes.

There will be some common characteristics of energy community cooperatives and associations, due to the fact that they under Danish private law will be regarded as a commercial actor. Both types of companies generally fulfil the requirements, although the statutes must reflect the purpose and needs of the partners in relation to the operation of the Energy Community. In addition, it is relevant that these commercial actors also have a limited liability, meaning that no partner is personally liable, without restriction and with joint and several liability. Both types of legal form is, therefore, in line with the EU Directives' regulation of openness and decision-making in the energy community.



The following table shows a comparison between the Cooperative and the Association, with particular focus given to pointing out

similarities and differences of the two forms of company proposed for the establishment of energy communities:

Function/task	Cooperative (limited liability)	Association (limited liability)
Involved partners	To be specified in statutes, but according to EU: citizens, housing societies, institutions, municipalities, small businesses	To be specified in statutes, but according to EU: citizens, housing societies, institutions, municipalities, small businesses
Partner ownership	Shares in the cooperative	Membership of the association
Partner equality	The statutes must ensure that share holders are at equal footing i relation to the purpose of the energy community	The statutes must ensure that members are at equal footing i relation to the purpose of the energy community
Functional area	Engages in economic activities on behalf of the share holders	Engages in economic activities on behalf of the members
Economic basis	The coop shares provides the cooperatives capital - which can be extended with an annual contribution and payments for specific energy services	Membership can be based on a contribution, that provides the associations capital - which can be extended with an annual fee and payments for specific energy services
Decisive power	The Members Council, which can delegate tasks and competences to a management board	The general assembly, which can delegate tasks and competences to a management board
Company law	Law on business companies put demands on the structure of a cooperative	Law on business companies specifies very few demands on the structure of an association
Company registration	The cooperative's statutes must be registered and accepted by the Danish Business Authority a.o. to safeguard the limitations on liability	The association's statutes must be registered and accepted by the Danish Business Authority a.o. to safeguard the limitations on liability
Basis for voting	At the outset it is the size of the share that detimines influence, but the statutes can regulate this with different weights in relation to types of decisions	At the outset members have equal influence, but the statutes can regulate this with different weights in relation to types of decisions

The association is in principle the most flexible company form of business law, since it allows for greater scope of variation in the design of the articles of association. It may therefore take into account specificities and tasks, such as having energy installations within the energy community

of which part are owned and administered by the parties jointly, and part individually. Cooperatives, on the other hand, are better known in connection with energy installations in the Danish context.





The EU Directives, as also set out in previous sections, emphasize that an energy community has the right to activities consisting of the production of electricity (and heating). This specifically includes production based on renewable energy sources, as well as distribution, supply, consumption, aggregation, energy storage, energy/electric vehicle charging services, and provision of other energy services to its partners.

## VARIABLE PRICES OF ELECTRICITY AND HEATING

A number of studies have been carried out on price signals as a way to regulate the behaviour of consumers and businesses, in particular within the electricity sector. They have led to the conclusion that consumers do not react specifically to price changes, and if they do, it is as step-wise changes in behavior. The simple reason is that the individual consumer or household is very bound by daily routines and practices, where a variation in electricity prices does not play the big role in the short term.

In the future, first electricity and then heating will be settled with time-varying prices across the day and night, possibly also over the year. Prices will depend on the production of electricity and heating in the national and regional networks. This because more professional organizations will be able to manage consumption times, and turn installations on and off making the integrated energy system more efficient, and adjusting consumption to the varying weather-dependent production pattern. This makes it possible to avoid unnecessary capacity extensions to provide for peak load periods.

While it is clear that, in general, sale of electricity (and heating) cannot in the future be on a fixed price independent of the time of

In consequence, the future Danish legislation may not create obstacles to the practical ability of the energy community to enforce this right. This requires a framework for interaction with existing collective energy supplies for electricity and heating as well as the collective infrastructure for the distribution of energy, which also defines constraints on how an energy community can operate and which financial benefits it can offer its partners and energy users.

consumption, there are two challenges in choosing a generally applicable pricing model for electricity and heating. Firstly, the liberalized trade in electricity will imply that electricity trading companies can choose to offer different “products” where some are based on fixed, known prices and others will involve different

*“Prices for power and heat will vary over time in the future to support load shifting”*

kinds of price variation. Secondly, it would be difficult also for an energy community to manage their own energy production only based on the fluctuating prices, which do not necessarily follow a recurring daily and weekly variation. This is as opposed to the energy community’s own production and consumption of energy, which more easily can respond to fixed prices within specified time intervals.

However, it is desirable to avoid grid peak load and rapid changes in demand resulting from customers’ responses to variable prices of electricity. Therefore, a distinction must be

made between the different “products” that the electricity trading company can offer, and their responsibility to the entire electricity system. Along with large corporate and other profession-

al customers they will be responsible for their consumption and to contribute to flexibility and the leveling of loads.

## USE OF THE COMMON GRIDS

For almost all energy communities, their relations to the supply infrastructure in both financial and technical terms will be crucial for both operations and investments. These are essential for an energy community to internally achieve financial and comfort benefits, while being able to reduce its electricity consumption, and provide flexibility to the regional energy system. Here, three things are of particular importance: The use of, or connection to, the collective grids; tariffs for the transport of electricity and heating within the community, as well as transport between the community and other producers and consumers; and costs of metering and data connections.

Few energy communities will benefit from building their own grids and operate as an autonomous energy “island”. For society as a whole, and most energy communities, it will be beneficial to use the existing and possibly new common grids. Both aspects are regulated by the EU Directives, which require grid operators to cooperate with energy communities and facilitate the transmission of energy through and within the community (Renewable Energy Directive 2018/2001, Art.16), while stating that they have the right to own, establish, buy or lease the acquisition network (Electricity Market Directive 2019/944, Art.15).

The model outlined in Figure 1 (in the section on ‘What is an energy community?’), on the use of a virtual grid, with tariffs based either on e.g. reserved capacity or with a rental/leasing

arrangement is a way of paying for the use of the collective grid. It would also discourage the creation of parallel supply networks. It ensures, through agreements, that the extension of network capacity can be limited.

Proprietary networks exist today around large companies acting as a single client, as well as e.g. some allotment associations having joint ownership of the land. Energy communities that produce their own energy reduce peak loads and will thus overall reduce the need to build new network capacity. They should therefore not be charged based on average costs, which do not apply in their case. Nor should they be placed at a disadvantage to large companies, as access to smart meters is already burdened with a subscription fee per customer/meter.

*“Energy communities can benefit from using the common grid if not hindered by tariffs and access rules”*

In the current electricity system, network tariffs which have typically been paid after consumption (per kWh) has meant that the actual electricity price is only a minor part of the total payment for electricity. Consequently, a variation in the electricity price has had little impact on the total electricity bill in smaller businesses, institutions and households. At the same time, the network tariffs illustrate that the costs of

distributing electricity are a significant part of the cost of this form of energy – in particular concerning the distribution of electricity over long distances, where grid losses are significant.

In addition to this, the Danish government has collected a duty on power consumption. By way of illustration, the total fees and duties (including the PSO charges) in 2018 were 1.16 DKK per kWh, while the net tariffs were 0.08 DKK to Energinet, between 0.11 and 0.22 DKK to the local network tariff and between 0.005 and 0.1 DKK in subscription per connected customer. This should be compared with 0.24 DKK per kWh as the average electricity price.

Currently, a distinction is made between three different customer segments for electricity, based on the level of consumption or voltage level with which they are connected to the grid. Households are typically connected locally to cable in the 0.4 kV grid close to the individual property and rent a local meter with the payment of a C tariff. Larger companies will be connected to a 10 kV network with a B tariff, while even larger production units will be connected to the 50 kV network with an A-tariff.

Large customers thus pay substantially less in the regional network tariff than households. This distribution is unlikely to be tenable after the implementation of the new directives. The EU Directives emphasize the requirement to operate with cost-based network tariffs. It is essential that this principle is outlined clearly in future Danish regulation, since it has been treated more as an overall non-profit principle in the previous network tariff definition. A non-profit principle in the sense of allocating the total costs (of operation, administration, maintenance, network losses, capacity upgrade, and provision of new networks) amongst the paying network customers through connection charges, meter rental, and tariffs

charged to different client groups. This means that e.g. investments in the reinforcement and replacement of a worn out grid are spread across all customers through a total balancing of costs. In future, this allocation must take into account how energy communities can reduce these costs.

*“In the future, prices of electricity and heating will vary over time”*

Implementation of the directives must necessarily take into account the elements of proximity mentioned in the directives (RE Directive 2018/2001, Art.2 and Art.21; Electricity Market Directive 2019/944, Art.16). The implementation will here benefit from distinguishing between the physically coherent local energy communities (with proximity as a criterion), and distributed energy communities (where no provision is made for distances). This is a distinction which is difficult to avoid, since the provisions of the Directives laying down network charges (tariffs) specifically introduce a differentiation of local tariffs, so that the current situation of two network tariffs cannot be continued, but requires the addition of a third level reflecting a boundary between activities within the Energy Community, and the surrounding networks and energy activities.

The following table shows how proximity and the requirements of the Directives on cost-oriented net fees (tariffs) interact with different forms of ‘ownership’ and access to the network (collective, private and virtual grids).

Type of energy community	Ownership/access to grid	Within the energy community	Outside the energy community
Distributed community	Common grid	Standard grid-tarifs	Standard grid-tarifs
Local energy community	Common grid	Standard local grid-tarif	Standard grid-tarif for exchanged power
	Virtual grid	Renting / leasing – access to capacity	Standard grid-tarif for exchanged power
	Private grid with one customer	No tariff due to private ownership	Standard grid-tarif for exchanged power
	Private grid / common among several customers	No tariff, free choice of power-trader with local tariff	Standard grid-tarif for exchanged power

Some of the same conditions apply in the case of district heating, but here the allocation between the price of producing the heating itself and the distribution of it has been hidden in one total price. This has not reflected, and therefore has not taken into account, losses, or variations

in costs of production across time of day, week and year. The payment for district heating in the future will therefore need to be reviewed, not least to support the establishment of energy communities.

## OTHER ‘NEW’ ACTORS – IN PARTICULAR IN THE ELECTRICITY MARKET

In order to more fully understand the intended regulation of the energy system, with energy community as one of the new actors, it is appropriate to also clarify the role that consumers can take under the EU directives, by being ‘prosumers’ (producing consumers), either as active customers (Electricity Market Directive 2019/944) or as renewables self-consumers (RE Directive 2018/2001). In addition, the new market actor, the ‘Aggregator’, which has already for some time been discussed and experimented with in connection with the energy transition, must be addressed briefly.

The role of ‘prosumers’ is already present today in the Danish energy system, as consumers investing in solar panels and/or heat pumps. Renewables self-consumers are attributed some rights, but their ability to act is, at the same time, limited to “buildings”, “housing societies” or “property boundaries”. These types of boundaries have, over the past decade, repeatedly proved to be almost arbitrary and have made exchanges of electricity between ‘neighbours’ a legally difficult and financially bad deal due to excessive tariffs.

These challenges are not solved by the Directives, despite their strong emphasis that unnecessary obstacles should not occur.

The trade between 'prosumers' is known as the 'peer-to-peer' business – that is, direct trade between users. This is opposed to ordinary trade, which is done anonymously and without individual customers knowing who produced the electricity. This latter type of trade will be subject to the standard network tariffs and charges, and will therefore not provide a specific incentive for 'prosumers' to trade e.g. electricity. There is no direct solution in the EU directives for the actors in the Danish energy sector, which have so far been limited by Danish electricity regulation. If you do not as a household, housing society or business consume your privately produced electricity from e.g. photovoltaic cells within your own property or land register, network tariffs and charges cannot be avoided.

The aggregator, as a new market actor, is established to manage the timing of electricity and heating consumption. It can thus contribute with 'flexibility' or 'capacity' to avoid peak loads in the overall energy system. These are services that will be in demand from the electricity market at least at some of the time, when for instance production cannot be made available or the electricity grid does not have the necessary capacity to transport the quantities demanded.

Essentially, there are four types of new actors, with their own sets of related rules for the organization of production and trade. The new 'energy communities', along with 'prosumers', have the right to produce, consume, store and sell electricity, including based on renewable energy. They further have the right to act in the energy market by taking on a role similar to the electricity trader. The third new concept is that of 'peer-to-peer trading', which can take

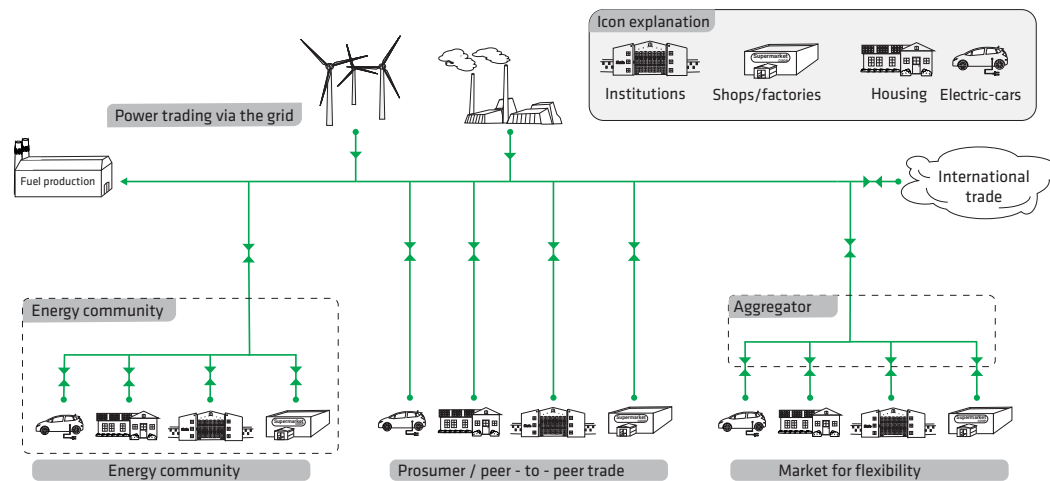

Figure 5: An illustration of the four new kinds of actors in the electricity market: energy community, prosumer, peer-to-peer trade and aggregator – connected to the overall electricity grid and market.

place outside the open market for electricity as trade directly between prosumers. The fourth new functionality is 'aggregation', which can be performed by an electricity trading company or other market actors, but which can also be functionally performed by an energy community.

These four are illustrated in relation to the overall electricity market in Figure 5, where the emphasis is on showing the new roles assigned to energy communities, 'prosumers', peer-to-peer trade and aggregators, respectively.

For those energy actors who have taken the step from being individual customers and consumers to 'prosumers', the issue is that the regulation envisaged by the directives do not directly solve previous controversies over e.g. the accounting for privately produced solar power, and the sharing of energy with neighbours. This could be solved by establishing a system through the Danish implementation, which assigns a special 'neighbouring tariff' and modified charge for trade between neighbours and within limited and local parts of the network. Another way to address this issue is to formalize local cooperation in an energy community. If no particular action is taken, either by incorporating a new tariff framework into the implementation of the directives, or by the network companies bringing these considerations into a future tariff structure, the end result will be active customers purchasing batteries to increase

the use of own electricity production, without this having a positive effect on the transformation of the overall energy system.

The particular advantage of energy communities is that they can contribute all of the four functions. They have all the same rights as 'prosumers', but in addition to this they can also secure a local balancing of consumption in relation to e.g. prices and tariffs, as well as enter into trade with grid "flexibility" and "capacity", thus taking on the role of aggregator.

There is a particular challenge linked to the energy community's option and right to operate as buyer and seller in the overall electricity market (regulated in Denmark by Energinet). The exercising of this right will result in the energy community also undertaking the general grid balancing obligation of market actors, and consequently an obligation to pay for imbalances caused by the activities of the community, and any deviation from contracts for the sale and purchase of electricity. However, this balancing obligation may be delegated to an electricity trader, leaving the energy community free to focus on the optimization of its own energy installations and delivery of related data, rather than build specific competencies related to acting on the electricity market. Similarly, an energy community may well functionally perform tasks of an aggregator, without assuming the market role of trader in flexibility and capacity.

*"In the future, we are dependent on using the right energy at the right time"*

## DUTIES PAID TO THE STATE AND THEIR PURPOSE

Since 1977, there has been a duty on the consumption of electricity in Denmark, weighted towards the housing sector due to a wish to reduce charges on business activities. The rationale behind these duties was, amongst other things, to incentivize energy savings. Reducing energy consumption remains important, but the main focus has today shifted to the phasing out of fossil fuels. The EU Directives do not address this type of duties to the State. Any wish to revise the charges are curbed by the fact that the electricity duty is a tax revenue, and thus falls under the jurisdiction of the Ministry of Finance rather than the energy authorities.

A CO<sub>2</sub> based duty, based on the emissions from electricity generation or on the actual consumption of fuels, will be much more in tune with today's climate political goals. A continuation of the general electricity duty in its current shape, on the other hand, will be almost counterproductive. While a future duty should continue to incentivize reductions in energy consumption, it must also contribute to the sustainable and fossil-free transition of the energy system, in a way which it currently does not.

Hence, in terms of climate policy considerations, it is central to structure the future duty system in order to promote, rather than hinder, the sustainable transformation of the energy

sector. Therefore, a substantial part of the future tax revenue must be derived either from a CO<sub>2</sub> based tax, or by the taxation of fossil fuels (including biomass) in a way which promotes the continued transformation.

A consolation in this context comes from the current Danish "Law on the taxation of electricity" from 2017. While establishing that in general duty is due on all electricity consumed in the country, both through delivery and own production, it excludes production facilities of less than 150 kW. It further excludes installations that produce electricity from wind, hydropower, biogas, biomass, solar, waves, tides, and geothermal heating, where the energy is directly consumed by the electricity producer or by a tenant of a property located in conjunction with and owned by the electricity producer. A minor adaptation of this Act will support the deployment of renewable energy, also through energy communities.

In order to avoid that duties dominate in the end-consumer price on electricity, thus reducing the impact of price variations as a steering instrument, it would be highly beneficial for the transformation of the energy system, if these duties were not only dependent on consumption (kWh), but, for example, dynamically followed energy prices.

*"Duties must be designed to support the climate transition rather than counteract it"*

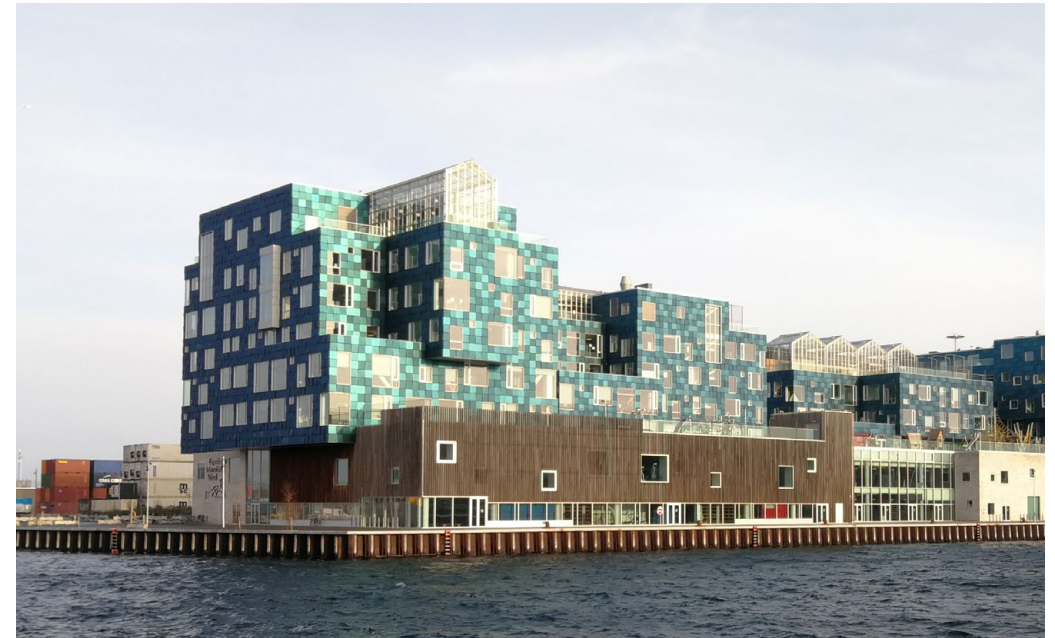

## OPPORTUNITIES TO CARRY OUT EXPERIMENTS

Under the previous government, an energy agreement was reached with all the parties in the Danish Parliament. Amongst other things, this agreement refers to the need for regulatory Free Zones, which can provide a framework for major experiments to further the energy transition, especially in areas with local initiatives around providing energy flexibility in combination with energy savings.

Energy communities cannot in general be considered as 'experiments', since the framework for energy communities and the related general principles for determining e.g. network tariffs are a requirement of the new EU directives, and must be implemented in Danish legislation in the course of the coming year.

However, there are aspects which the EU Directives do not take into account, such as the

need to redesign and change the regulation of the heating supply, as well as its partial electrification. It will make sense to support large-scale experiments as the basis for implementing a more consistent and stable integration of energy systems across electricity, heating, cooling and gas, so that they can effectively contribute to and be part of the overall energy transition. This will provide a stable framework that facilitates the energy transition and allows experimentation with the necessary long-term investments. It will also be able to contribute with experiences supporting the development of future district heating regulation, as well as provide lessons to help scale the creation and deployment of energy communities.

## 44 Action plan to establish an energy community

The starting point of any project aiming to set up an energy community must be to clarify the general ideas and principles of the community – defining its fundamental idea and objectives. It may be motivated by the desire to create greater local cohesion amongst citizens, institutions and businesses. It can also be justified in terms of taking concrete action to reduce a neighbourhood's climate impact, or to supply better and cheaper renewables-based electricity and heating to an area.

*“The first step is to get in touch with the other relevant stakeholders in the local area”*

After this comes a number of important steps, which all contribute towards the process of realizing the idea of an energy community:

1. Initiators must get in touch with the other local actors they want to involve, and seek their support for the idea through dialogue. In this way they can garner support for the central idea and objectives of the energy community, as well as show willingness to incorporate the wishes and ideas of potential new partners.
2. It is then important to clarify how many partners will contribute to founding the energy community. Each must decide how many resources they are able to dedicate to supporting the further process, in terms of both time and, potentially, access to finance. This must be considered by each individual partner, as well as collectively.
3. It is necessary to provide a solid baseline for the existing energy supply. This may include an analysis of heating and electricity consumption for a full year, as well as a number of selected weeks and days. In addition, the structure of the existing energy systems should be mapped, in terms of connection points and energy transport capacity. This could be complemented by an analysis of heating systems and buildings (Heat optimized buildings, 2019).
4. Next it may be useful to set out different scenarios for the extent of the energy community, in terms of which partners should be involved, and consequently which consumption levels and profiles are represented. It will for instance often be relevant to look at two or more delimitations of the energy community, where one involves e.g. households only, while another includes local institutions, shops, and possibly small businesses.
5. Establishing an analytical framework for the energy community's technical composition based on renewable energy technologies. Then, outlining combinations of appropriate configurations of renewable energy components, corresponding to the identified scenarios and what they require of buildings and land use.
6. Obtaining information on possible sources of funding for the investments needed to establish the Energy Community.
7. Outlining the organizational framework of the Energy Community, through a review of the possible legal forms and a detailed discussion of their respective advantages and disadvantages. This may then result in a set of statutes and the establishment of the energy community as a company.
8. Calculating an 'optimal' mix of renewable energy production and the need for storage technologies in the modelled scenarios, resulting from a technical-financial calculation of investment and operating costs. This aims to clarify the benefits provided by the energy community, in both increased comfort and financial terms. In this connection it will be necessary to gather information on tariffs and levies, which may

make it necessary to apply as an experimental project in order to maintain certain framework conditions.

9. Establishing an overall timeline and financing plan for the realization of the various sub-elements of the organizational and technical architecture of the Energy Community. This may involve choices between the identified scenarios, and the adaptation of technical ambitions to funding opportunities.
10. Implementation of the project with the involvement of relevant contractors and technical advisers, and divided into sub-phases if appropriate.

It is important during the whole process to base the work within an initiator group, which keeps in touch with both the partners and end-users who are to benefit from the energy community. During the process of realizing the energy community, this group will have to be transformed into a more formalized coordinating group, and eventually become a formal corporate organization, without losing this contact with the partners and the end-users involved.

### References

Renewable Energy Directive (2018). EU-directive 2018/2001 supporting the use of energy from renewable sources.

Electricity Market Directive (2019). EU-directive 2019/944 stating common rules for the inner market for electricity.

Ceva (2017). The comeback of municipalities as supply companies – insights from reforms of the supply sector in Europa. (In Danish: Kommunernes comeback som forsyningselskaber – Indsigter fra reformer af forsyningssektoren i Europa, udarbejdet for 3F).

Annual Environmental Strategic Meeting (2017) (In Danish: Miljøstrategisk Årsrapport). IDA og DIST-centret, Aalborg Universitet.

Energy communities in legal context (2019). (In Danish: Energifællesskaber i retlig belysning). Erik Christiansen, EBO Consult.

Lov om erhvervsdrivende virksomheder

Tariff model 2.0 (2018). (In Danish: Tarifmodel 2.0). Dansk Energi.

Act on social housing societies. (In Danish: Lov om almennyttige boligselskaber).

Heat optimized buildings (2019). (In Danish: Varmeoptimerede bygninger. Energiforum Sydhavn.

Miljøstrategisk Årsrapport (2017). IDA og DIST-centret ved Aalborg Universitet.

Energifællesskaber i retlig belysning (2019). Notat ved Erik Christiansen, EBO Consult.

Tarifmodel 2.0 (2018). Notat ved Dansk Energi.

Lov om erhvervsdrivende virksomheder.

Lov om almennyttige boligselskaber.

Varmeoptimerede bygninger (2019). Energiforum Sydhavn.



## Technology Catalogue

The Technology Catalogue includes the most relevant renewable energy technology components which can be used by an energy community. It describes their key capabilities and relative size, as well as requirements for access to space respectively to energy grids. For each component, information is provided in a tabular format containing comparable information and includes sketches and graphs illustrating the technology. In addition, examples of their operational characteristics in terms of time of production/use, and where appropriate, variations in efficiency. In the end, the potential for interconnectivity in local grids is derived from model-based considerations. The last two points are illustrated by graphs of potential benefits and diagrams showing how components are interconnected.

New legislation is in the making and thus also new calculations concerning tariffs and prices for electricity and heat. This as a result of the

Danish implementation of the new EU Directives on RE and the organization of the electricity market, see the section on “Energy Community Energy and Infrastructure interactions with this Manual”. These new conditions will also affect the boundaries of local – possibly virtual – use of the common grid that an energy community will have access to, as well as prices, tariffs and charges from grid companies and utilities. The impact of these factors will have a significant impact on the way the different technologies can be configured, see the section on “Energy Community components” of the Handbook.

All price assessments are based on Danish prices from 2020. As prices and VAT may differ from country to country the prices are kept in Danish Kroner (DKK) throughout the Technology Catalogue. The typical exchange rate is 7,45 Danish Kroner for one Euro.

### CONTENTS

1. Use of existing grids and meters in the energy community .....	47
2. Solar pv connected to local consumption .....	51
3. Local pv production and storage for flexibility .....	59
4. Heat pumps with local energy sources - general information .....	65
A. Source: geothermal .....	71
B. Source: lake/sea water .....	78
C. Source: air .....	84
D. Source: roof surfaces .....	88
5. Buffer heat tanks for smoothing peak loads .....	92
6. Combination of electricity based transport and use of batteries for flexibility .....	98
7. Combined shop cooling and heat recovery .....	105
8. Additional electricity heating of domestic hot water .....	110
9. Solar heat added to the heating system .....	114

## 1 USE OF EXISTING GRIDS AND METERS IN THE ENERGY COMMUNITY

Energy communities will have an important role to play in the emerging local energy systems and can also contribute to the sustainable transition. New network tariffs are emerging as a result of the implementation of the new EU Energy Directives. The new rules will deal with the exchange of electricity locally and how to make it easier for electricity customers to take part in the market through flexible consumption, or by themselves producing electricity, as well as being partners in local energy communities.

The organization of the grid of the energy communities will play an important role for the introduction of local renewable production in the existing collective supplies while at the same

time reducing energy consumption. It is important to develop the Energy Community based on local production of heat and electricity based on renewable sources and through a combined management of consumption and possible storage of energy. In this way, the price of electricity and heat can become lower.

At the same time, it is necessary to clarify how local distribution networks and meters are part of the energy communities.

- Existing grids
- Existing meters
- Energy community

### Technical description

Under the contemporary regulation, the grid companies have a monopoly on installing grids, even locally, ending at the main meter of each energy customer. In practice, this means that the vast majority of household are supplied individually, while typically larger companies may own their own internal grid. The new rules resulting from the implementation of the EU Directives will change these conditions.

If an energy community is established with own meters, it can take over the management of the local payment for consumption. But solutions could also be envisaged where the Energy Community rents the meters from the grid company opening in the future for new forms of cooperation between energy communities and grid companies.

- In an existing electricity grid, supply companies hold both billing meters and supply cables to consumers, as shown in Figure 1. The supplier company provides power to consumers who pay for the power and connection to the grid. Meters are typically placed at each apartment to account for the energy consumption of each consumer.
- Figure 2 shows the conceptual outline of an energy community taking an active role in the grid, as it can generate power based on integrating renewable energy sources, e.g. from a photovoltaic installation. The power can be used either in the energy community or supplied to the electricity grid. Batteries can also be installed to smooth consumption and store power surplus e.g. from day to night or over a weekend.

- An energy community can establish its own electricity grid and connect to the collective power grids via a main meter. It may install local meters in apartments rented from the utility company or set up new sub-meters as well as new cables. A main meter must be installed to account for the overall power consumption of the energy community (Figure 2).
- The most relevant model for an energy community's interaction with the collective supply grid is to rent/lease or otherwise pay for the use of part of the capacity on the local grid and thus effectively operate with a 'virtual' network to grid the installation of parallel grid.

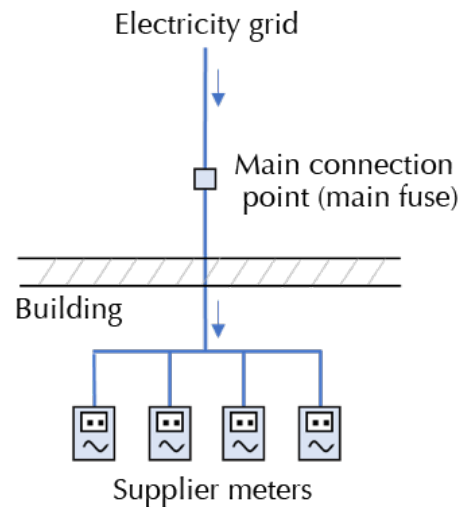

Figure 1 - Principle of an existing electricity grid

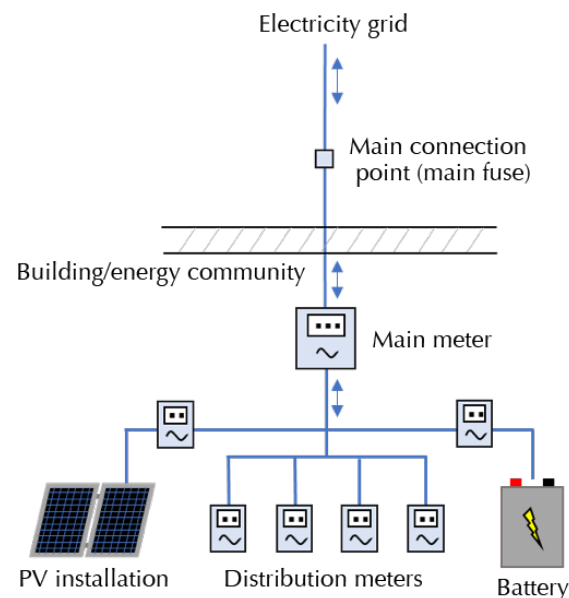

Figure 2 - Principle of the power grid in an energy community

## Properties

- The Energy Community is responsible for settling the energy consumption of the different consumers.
- In a general network see Figure 1, electricity meters and cables are owned by the utility. It typically costs 600-800 DKK/year on subscription. When establishing an energy community, it can either create a comprehensive rental scheme for the meters or buy existing meters from the utility, so that consumers are set up or do not have to pay for the subscription.
- Existing settlement measures may be taken by the Energy Community in order to settle the energy consumption through the transfer of data from the network company. In new buildings, an energy pool may choose to install own new meters.
- As shown in Figure 3, an energy community will be established across several (multiple) buildings and even more local actors (home companies, shops, municipal institutions and small businesses). The energy community can choose to exchange electricity through an own grid, but it will have the effect of establishing parallel electricity grids. More relevant will it be that low agreement with the local network company to lease/lease or otherwise make use of the collective network, through the availability of a virtual part of the network. This will allow existing smart meters to work together as the data basis for the Energy Community. Thus, a combination of key meters can be worked out for some of the partners and for others.

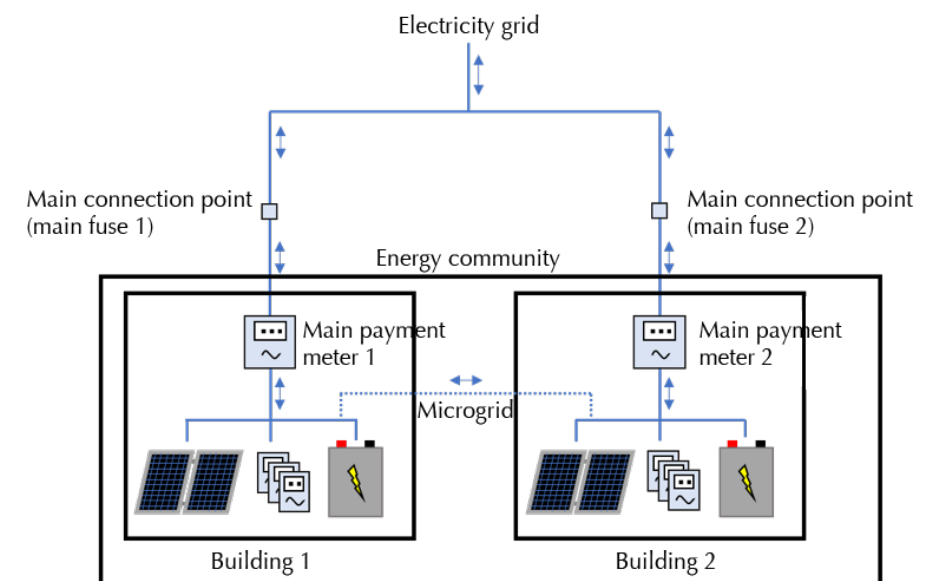

Figure 3 - Outline of the electricity grid with multiple buildings in the Energy Community

ADVANTAGES	DISADVANTAGES
+ Renewable energy can be integrated and distributed locally	- Costs of renting or buying meters
+ This opens for improved flexibility of the energy grid	- Costs and management of services that eventually can be purchased from outside
+ Save grid-tariffs within the energy communities, while only paying for the actual exchange with the surrounding supply grid	- Demands a clear deal with the local energy grid company about the payments for using the common grid to avoid building parallel microgrids
+ Improved utilization of the renewable electricity, as losses in the grid are saved	
+ Own energy data can be used to smoothen loads, to identify energy savings and to visualise consumption	
+ Establishing an energy community extends the opportunities to exploit renewable energy sources in the power grid and to reduce environmental loads	

**INSTALLATION REQUIREMENTS**

- The possible establishment of some key meters for some partners in the Energy Community
- The establishment of a common data management based either on own meters or with the data from intelligent meters leased from the supplier company.
- The possible installation of local parallel networks if use cannot be made of the use and fair settlement for the end users of the collectives,
- Cost allocators for common consumption (e.g., lift, laundry, outdoor lighting, and combination)

**ECONOMY**

Typical yield	Equipment costs (excl. VAT)	Installation costs (excl. VAT)	Cost of operation and service (excl. VAT)
n.a.	Difficult to estimate	n.a.	n.a.

**Examples**

- Kamstrup (meters)

**2 SOLAR PV CONNECTED TO LOCAL CONSUMPTION**

A photovoltaic installation can be installed on the roof of building blocks to produce power from solar energy. Power can be used in the building/energy community or supplied to the electricity grid. The area covered by solar panels is typically 40 to 50 % of the roof area.

- Solar PV panels
- Local energy consumption
- Solar energy

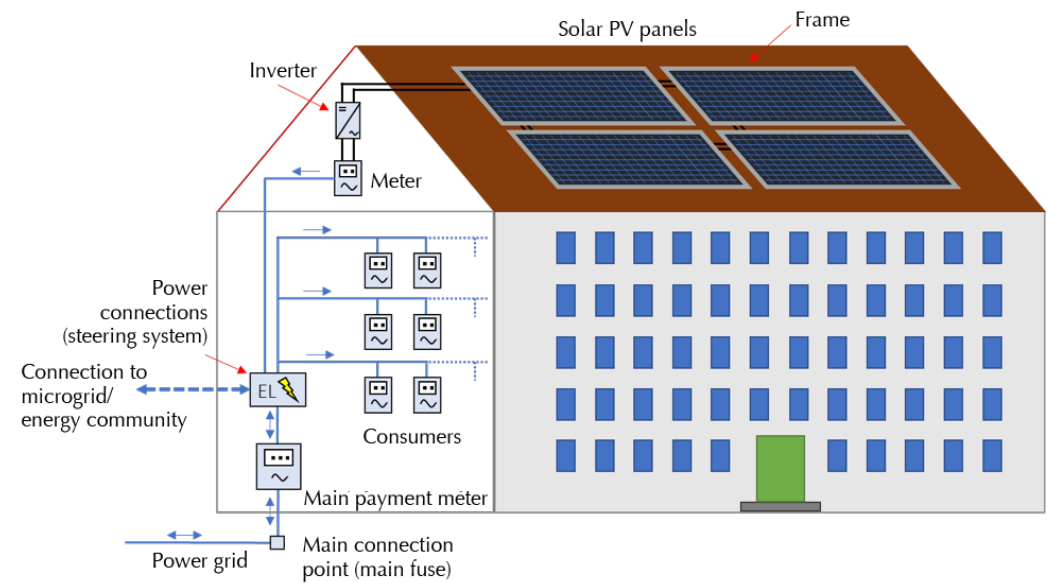

Figure 4 - Conceptual design of a PV installation in a energy community

## Technical description

- It is necessary to clarify whether there are specific local teams. The municipality may set boundaries to install a photovoltaic installation [1].
- Collect tag data to assess whether the roof is to be renovated before installation [2].
- To study the energy needs of the building or energy in order to assess the size of the plant [2].
- Clarification of the electrical installations on the land register as well as any special arrangements from local electricity grid business [1]. When a photovoltaic installation is made, a method of charging can be chosen in relation to power generation. The Energy Agency's definition of guidelines by way of a method of settlement [6]. An energy community can establish its own virtual network and admin the local payment for consumption.
- The solar panel modules should be securely attached to the supporting structure in a way that does not contain any leaks in the roof or wall of the wall.
- Solar panels have a typical effect between 200 and 350 Wp [3].
- A typical size of a commercial solar installation is between 50 and 500 kW and can be installed in residential buildings, offices or public buildings. In general, an installation has a size factor of 1,1-1,2 in relation to the power requirements of the building, in order to take account of the structural dimension of the building.
- A battery pack can also be used to store power from electric grids during low-peak power periods. This solution reduces the power needed to power the electricity grid over peak load periods.
- Transmission losses in the electricity grid are lower as the current is locally used.
- Lifetime of a photovoltaic installation is expected between 25 and 30 years.
- Lifetime of a battery pack is expected to depend on battery technology between 10 and 25 years.
- For a complete system, a system of management must be installed as well as an inverter.
- The effect of inverters is important to define the maximum power limit that can be delivered from the installation to consumers. Inverters may be controlled by the operator of the power network for balance and stabilisation purposes.



Figure 5 - Example of solar PV installation on a flat roof (orientation towards east/west)

## MOUNTING

Solar panels work best when facing south. A typical slope is between 15 and 45 degrees. As both direct and diffuse light is used to generate power, the information of the PPE modules is not particularly important. It is also possible to consider the installation of solar panels to the north if the project's economic performance we see good. There is a variety of ways to establish photovoltaic installations and solutions should

be calculated to safeguard the economy of the project. On flat roofs, a frame must be installed to support the required slope. Figure 6 shows the relationship between the generation of electricity from the panels and their orientation.

The facility as shown in Figure 7 can optimize power generation, but with risk of shadows from panels in the first rows.

Tilt angle	Orientation of solar panels													
	West		South-West				South		South-East				East	
	90°	75°	60°	45°	30°	15°	0°	15°	30°	45°	60°	75°	90°	
0°	1,00	1,00	1,00	1,00	1,00	1,00	1,00	1,00	1,00	1,00	1,00	1,00	1,00	
5°	1,00	1,01	1,02	1,03	1,03	1,04	1,04	1,04	1,03	1,03	1,02	1,01	1,00	
10°	0,99	1,01	1,03	1,05	1,05	1,07	1,07	1,07	1,06	1,05	1,03	1,01	0,99	
15°	0,98	1,01	1,04	1,07	1,08	1,09	1,10	1,10	1,08	1,06	1,04	1,01	0,98	
20°	0,97	1,01	1,05	1,08	1,10	1,12	1,12	1,12	1,10	1,08	1,05	1,01	0,97	
25°	0,96	1,01	1,06	1,09	1,12	1,13	1,14	1,13	1,12	1,09	1,05	1,01	0,96	
30°	0,95	1,01	1,06	1,10	1,12	1,14	1,15	1,14	1,13	1,09	1,05	1,01	0,95	
35°	0,94	1,00	1,05	1,10	1,13	1,15	1,15	1,15	1,13	1,09	1,05	1,00	0,94	
40°	0,92	0,99	1,04	1,09	1,12	1,14	1,15	1,14	1,13	1,09	1,04	0,99	0,92	
45°	0,91	0,98	1,03	1,08	1,12	1,14	1,14	1,14	1,12	1,08	1,03	0,97	0,90	
50°	0,89	0,96	1,02	1,07	1,10	1,12	1,13	1,12	1,10	1,07	1,02	0,95	0,88	
55°	0,87	0,94	1,00	1,05	1,09	1,10	1,11	1,10	1,08	1,05	1,00	0,93	0,86	
60°	0,84	0,92	0,98	1,03	1,06	1,08	1,09	1,08	1,06	1,02	0,97	0,91	0,84	
65°	0,82	0,89	0,95	1,00	1,03	1,05	1,06	1,05	1,03	1,00	0,95	0,88	0,81	
70°	0,79	0,86	0,92	0,97	1,00	1,02	1,02	1,01	1,00	0,96	0,92	0,86	0,79	
75°	0,76	0,83	0,89	0,93	0,96	0,97	0,98	0,97	0,96	0,93	0,88	0,83	0,76	
80°	0,73	0,79	0,85	0,89	0,92	0,93	0,93	0,93	0,91	0,89	0,85	0,79	0,73	
85°	0,70	0,76	0,81	0,85	0,87	0,88	0,88	0,88	0,87	0,84	0,81	0,75	0,69	
90°	0,66	0,72	0,77	0,80	0,82	0,83	0,83	0,83	0,82	0,80	0,77	0,72	0,66	

Figure 6 - Diagram showing solar panels orientation for optimized production in Copenhagen [3]

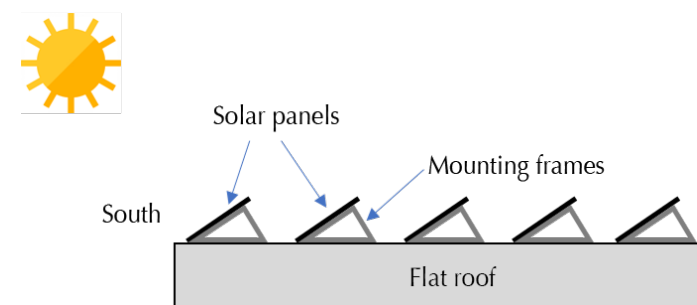

Figure 7 - Solar PV installation on flat roof tag turning south

Figure 8 shows another option where solar cells are oriented towards east and west. The orientation is not optimal, but several panels can be installed and the risk of shadowing is lower.

On a gable roof one can directly install panels on the surface, when orientation and slope are good. In particular, solar panels may become part of the roof construction where they are

used instead of roof tiles. As they are integrated in the roof structure, there is a lower risk of aesthetics complaints.

Some types of photovoltaics are to be installed on a framework also on a straddle roof, as they have one diode box on the reverse side. This box requires ventilation to cool the components when operating.

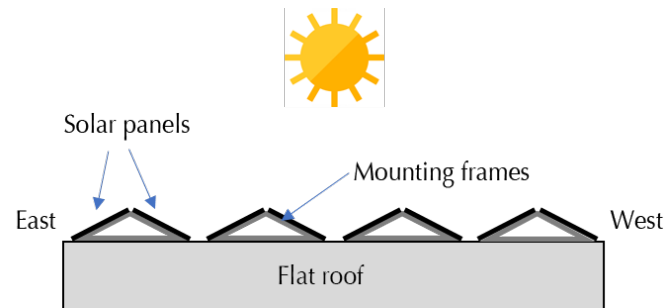

Figure 8 - Solar PV installations on a flat roof turning east-west, with double orientation

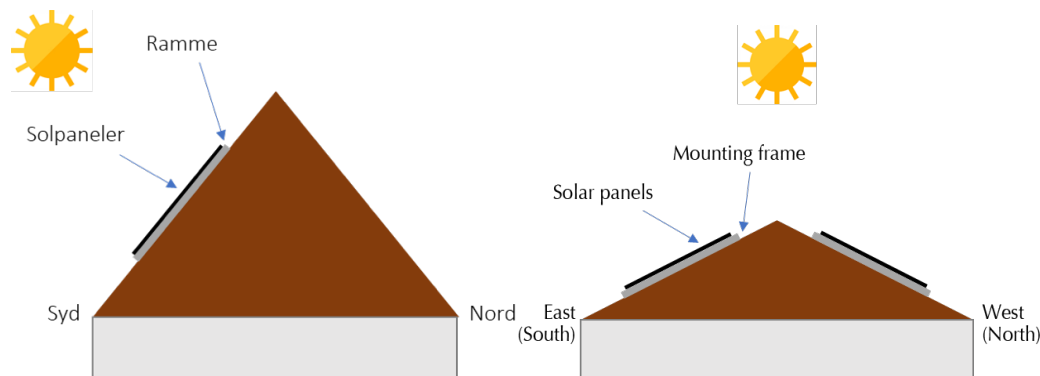

Figure 9 - To the left: Solar PV installation on slopy roof turning south (to the left)  
To the right: Solar PV installation on slopy roof turning both east and west

## Properties

A photovoltaic installation equipped with batteries can be used to achieve energy flexibility for the grid. The battery pack can be used to store electricity when renewable energy sources produce surplus electricity. The batteries can save energy both from the photovoltaic and the electricity grid, for example when there is a surplus from the turbines.

The average annual solar means offset on a horizontal surface in Denmark is  $1046 \pm 33$  kWh/m<sup>2</sup> years. Figure 10 shows the monthly sum of global exposure on a horizontal surface in Denmark. The figure shows both direct and diffuse components.

A battery pack has to be considered when a solar installation is installed. Batteries can store current when the panels produce surplus electricity.

Thanks to electricity storage, a solar cell can cover around 70 % of the electricity needs in a building. A battery pack is used to impure energy between hours up to a day. When the photovoltaic installation produces, batteries can store surplus production and afterwards they can supply electricity in peak periods when the electricity price is higher.

Figure 12 shows the battery capacity with a reasonable increase in the level of self-consumption, and where the increase in capacity yields only minor improvements. Applicable to installations where the consumption is the same all days [7].

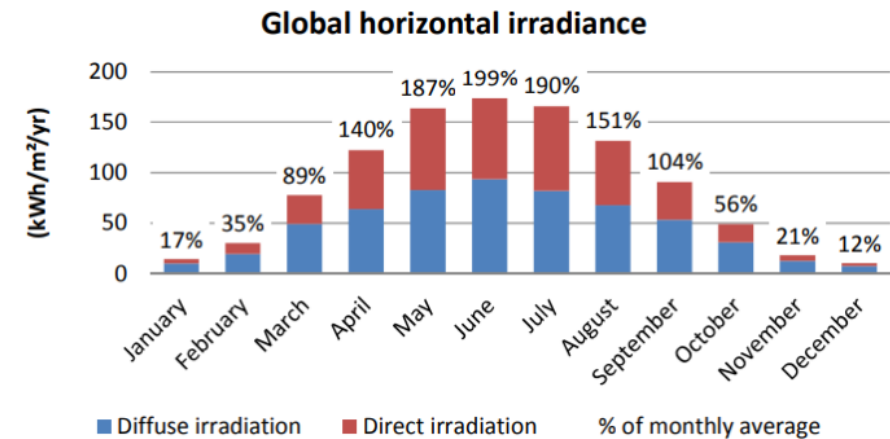

Figure 10 - Monthly sum of global solar radiation on a horizontal space in Copenhagen [3]



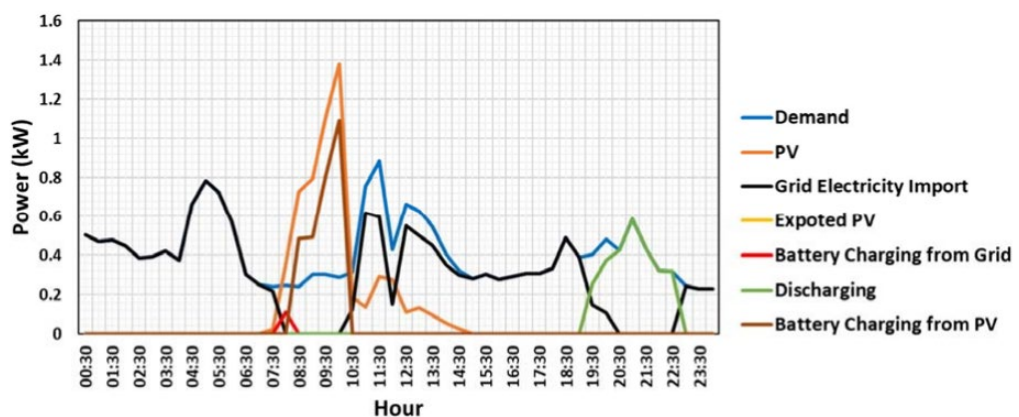

Figure 11 - The graph shows an example of power production from a solar PV installation integrated with a battery pack and the energy consumption in the winter term (simulated) [5]

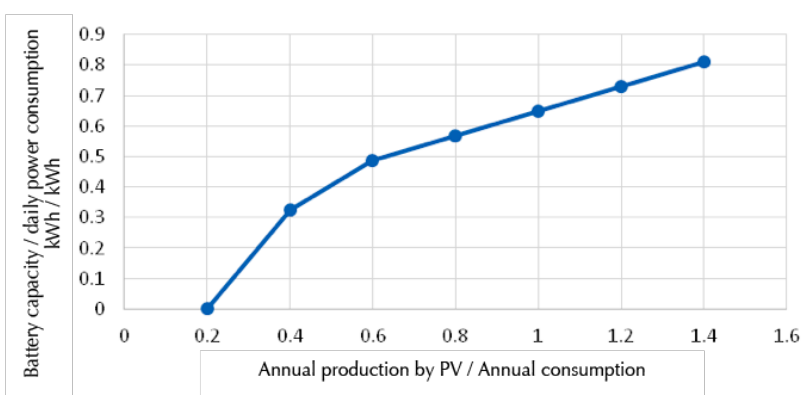

Figure 12 - Technical "reasonable" battery capacity for hybrid installations [7]

ADVANTAGES	DISADVANTAGES
+ Renewable energy	- Demands permission from the municipality concerning visual impact (colour and reflections) and the roof constructions strenght
+ No noise and pollution in use	- High installation cost
+ Power production during day time when consumption is highest	- A protection of a building or a declaration of a building worthy of preservation can block the installation of solar panels
+ Solar PV panels can be reused	- Solar PV production: some thin film technologies contain small amounts of cadmium and arsen
+ Low operations and service costs	- Risk of complaints about aesthetics, especially in cities
+ Batteries can be installed to store energy	
+ Power grid balance and stabilisation	
+ Smart-grid options	
+ Solcellerne er leveres som moduler og de er nemme at installere	

### INSTALLATION REQUIREMENTS

- Solar photovoltaic panels – mounting frame
- Inverter
- Electricity meter
- Connection to the electricity system
- Any batteries

### ECONOMY

Typical yield	Equipment costs (excl. VAT)	Installation costs (excl. VAT)	Cost of operation and service (excl. VAT)
Solar PVs 110 kWp	Approx. 3.800 DKK/kWp	Approx. 30-40% (proportion to equipment)	Approx. 77 DKK/kWp/year
Battery pack >50 kWh	Approx. 4.000-8.000 DKK/kWh	Approx. 20-30% (proportion to equipment)	Approx. 1-2% (of total costs)

Danish prices in 2020

## Examples

### PROVIDERS

- Racell power systems
- Lithium Balance A/S

### INSTALLATIONS

- Building blocks in the social housing sector

## References

[1] Danish Standard. 2013 Instructions on photovoltaic installations - composition, installation, connection and advice. Available online: <https://www.hfb.dk/fileadmin/templates/hfb/visitkort/pdf/artikler/Vejledning-om-solcelleanlaeg.pdf>

[2] Danish Energy Agency. Application process. Available online: <https://ens.dk/ansvarsomraader/stoette-til-vedvarende-energi/solceller/ansoegningsproces>

[3] Danish Energy Agency. Technology catalogue for the production of electricity and multiple heat. Available online: <https://ens.dk/service/fremskrivninger-analyser-modeller/teknologikataloger/teknologikatalog-produktion-af-el>

[4] DTU Energy, Department of Energy Conversion and Storage (2019). Whitebook - Energy storage technologies in a Danish and international perspective. Available online: <https://www.danskindustri.dk/globalassets/dokumenter-analyser-publikationer-mv/brancher-og-foreninger/di-branche-falleskaber/di-energi/ovrige-dokumenter/wec-whitebook-final-version.pdf>

[5] Sani Hassan, L. Cipcigan, and N. Jenkins (2017). Optimal tray operation for the PV system with tariff implication. *Appl. Energy*, Vol. 203, pp.422-441. <https://www.sciencedirect.com/science/article/pii/S030626191730778X>

[6] Danish Energy Agency (2019). Group change. Available online: <https://ens.dk/ansvarsomraader/stoette-til-vedvarende-energi/solceller/gruppeskifte>

[7] Steen Harlitigation, Peder Backer and Svend Erik Mikkelsen (2018). Elforsk project: BIPVT-E: Development of the governance strategy for flexible power generating modules with solar cells, solar thermal, heat pump, energy absorber, and battery storage. Available online: <https://elforsk.dk/sites/elforsk.dk/files/media/>

## 3 LOCAL PV PRODUCTION AND STORAGE FOR FLEXIBILITY

Power can be generated and stored locally to achieve energy flexibility in the grid. A battery pack is often established with a storage capacity in kWh corresponding to the installed capacity of PV installed in kWp. The simulation of the battery and photovoltaic installations can be carried out with a simulation program, e.g. "PV-Bat". A battery pack can be found in different sizes as prefabricated units (20-300 kW). The size of the battery pack depends on the econo-

my and building needs. It can be used to cover building needs during peak load periods when the electricity price is higher.

- Local production
- Photovoltaic
- Energy storage
- Flexibility
- Battery pack
- Electricity generation

## Technical description

- Power generation can be carried out locally by installing a photovoltaic installation on a roof on housing, public buildings or offices.
- The most used batteries are lead batteries, nickel metal hydride and lithium ion batteries. Lithium ion batteries guarantees the highest efficiency in the charging and discharging process.
- The lifetime of a photovoltaic installation is expected between 25 and 30 years, while the life span of a battery pack is expected between 10 and 20 years (depending on battery technology).
- Electricity generation from a solar installation shall only be used to cover local energy needs and if the installation produces surplus electricity, a battery pack can be used to store it. In this case the power has been used to reduce peak electricity demand during high peak periods. Thanks to electricity storage, a photovoltaic installation may cover about 70 % of the power supply in a building.

- A study showed that a battery pack can be installed in an apartment block and by considering a capacity of 0,8-1.3 kW per apartment it is possible to reduce peak load to 40 % [2].
- The study was carried out in blocks of flats with 18, 27 and 36 apartments. With collective meters, the payback period of the battery is 5-7 years [2].
- It is recommended not to locate battery installations in living spaces (e.g. indoor, kitchen, rooms). If the position is indoors, it may be, for example, the storage room, a technicians room or the like, which are normally shielded from other spaces. Placing in garages, shacks or similar is preferable with regard to safety [3].

- Temperature and humidity shall be considered in relation to the location of battery installations, as battery life deteriorates by very high and low temperatures. Batteries are best placed at about 20 °C and already at 30 °C can be seen a reduced lifetime. Batteries are also poorly functioning at low temperatures (typically < 5 °C). Installations should not be made in places with high relative humidity due to risks of condensation and corrosion [3].
- Battery installations are typically very heavy and their assembly has to be considered in this and as well as curtains. In particular, it is important to consider whether the floor can be used to limit the weight to which it is exposed. Remember also to respect the manufacturer's recommendations for distance (air) around the unit and ventilation apertures, as well as access to servicing the plant [3].
- It is recommended that battery enclosures are not placed in smaller spaces where its operation can lead to significant temperature increases with reduced efficiency and durability [3].
- Natural fans are recommended for the battery installation. This can be directly from the battery-box to freely placed and free of charge. Ventilation should be carried out to remove any gases if a fault situation is to occur [3].
- Indoors, it is not recommended to place installations larger than 30 kWh. In garages, shelters, carports and the like, facilities can be located 100 kWh or more with the permission of the local fire authority. Free standing outdoors may be placed in a substantially larger battery plant [3].
- The battery of a battery connected to the electricity grid shall comply with the requirements of Technical Regulation 3.3.1 for battery installations. All the plants on the positive list of batteries (administered by Dansk Energi) comply with TF 3.3.1 (for installations up to 50 kW) [3]. You can find the list at: <https://www.danskeenergi.dk/vejledning/nettilslutning/positivlister>
- DC cables between batteries and inverters should be kept as short as possible and should be kept very closely (preferably lightly twisted) in order to minimize fat losses and electromagnetic noise. Therefore, it is famed that batteries are placed in the immediate vicinity of inverters and that cables are not drawn across space and, moreover, be placed in a position of short circuit continuity [3].

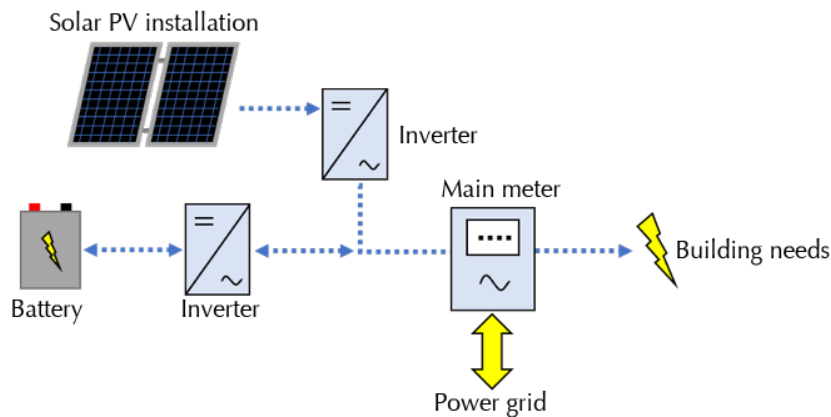

Figure 13 - Outline of an installation providing the local generation of electricity and energy storage.

## Properties

Figure 14 shows a simplified consumption profile where a photovoltaic installation, in conjunction with a battery pack, can help to reduce peak load in a building. As shown, the battery pack can be used to store energy during the night

when energy needs are low as well as the price of electricity. During the day, solar cell facilities can cover power needs and the surplus can be stored in the battery pack. At night, the battery may deliver the peak current in the peak load

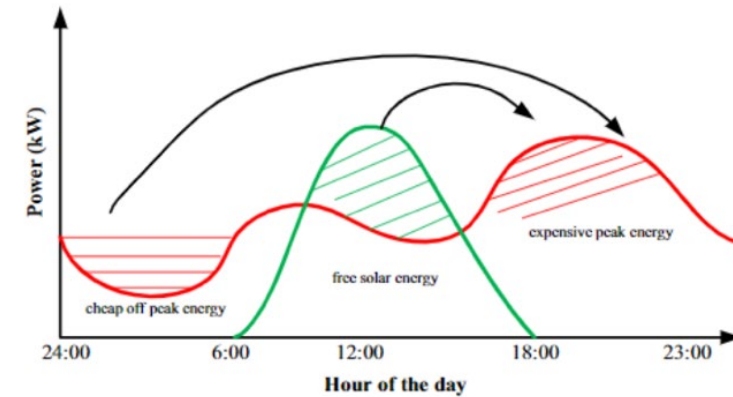

Figure 14 - Graph showing the interconnection between a solar PV installation and a battery pack [4]

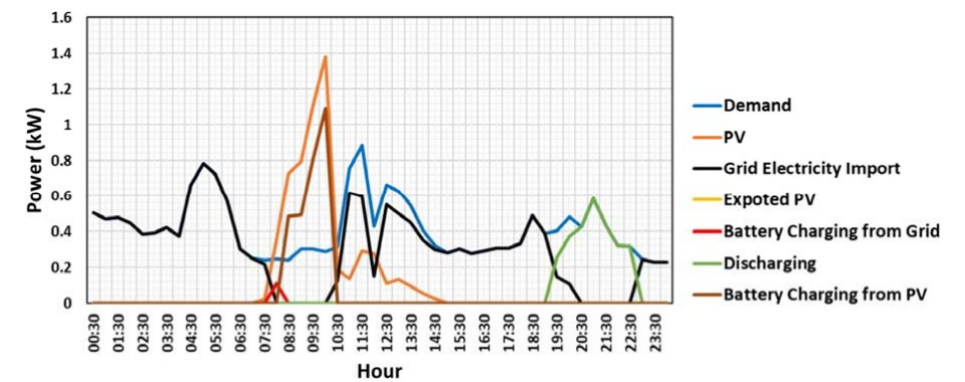

Figure 15 - Graph showing the ratio of power output from a photovoltaic installation integrated with a battery pack and energy use during winter (simulated) [4]

period. In this way capacity can be reduced from the grid and achieve a higher energy flexibility from the integration of the photovoltaic installations. Figure 15 and Figure 16 show an example of the consumption profile simulated to show power consumption displacement with a photovoltaic and a battery pack. Batteries are mainly being placed in storage and displacement within the 24/7 service, due to the relatively high price and shorter lifespan.

Moreover, batteries are best used in connection with photovoltaic installations which only produce today and research into energy.

Figure 17 shows the battery capacity with a reasonable increase in the level of self-consumption, and where the increase in capacity yields only minor improvements. Applicable to installations where the consumption is the same all days [5].

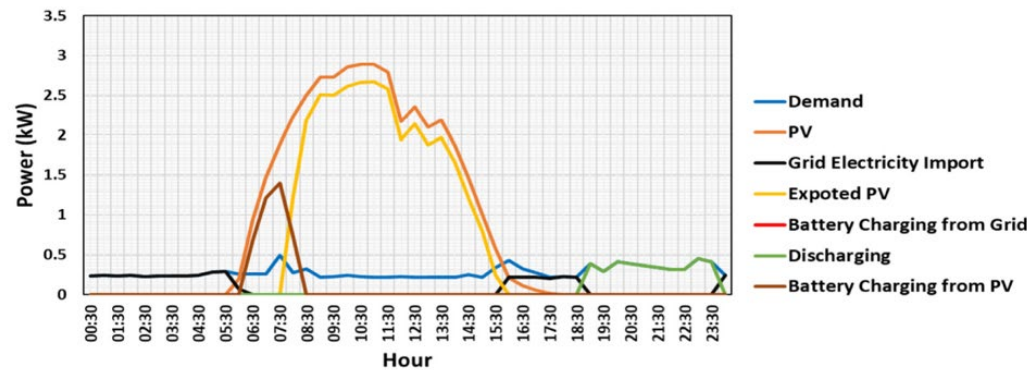

Figure 16 - Graph showing the ratio of power output from a photovoltaic installation integrated with a battery pack and energy use during summer (simulated) [4]

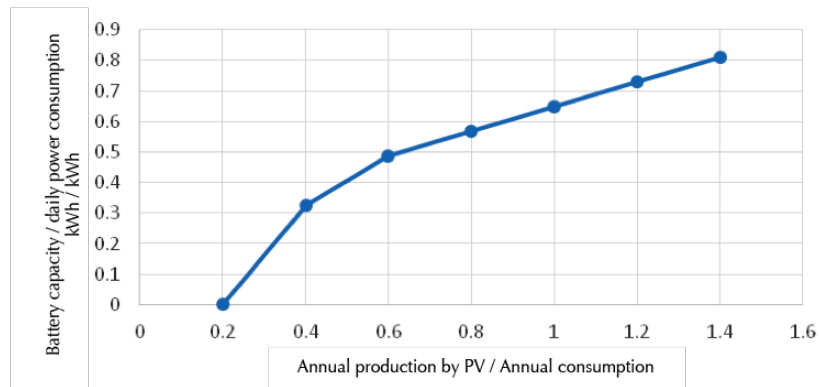

Figure 17 - Technical "sensible" battery capacity for a hybrid installation [5]

ADVANTAGES	DISADVANTAGES
+ Integration of renewable energy	- High costs of installation
+ Smart-grid options	- Battery production uses materials that are dangerous for people and pollutes the environment. In addition these materials originate from countries with a high geopolitical risk potential
+ Load shifting of power consumption	- Battery production uses materials that are have limited availability
+ Solar PV panels can be reused	- Reuse processes of materials from batteries pollute the environment
+ Low costs of operation and service	- Solar PV production: some thin film technologies contain small amounts of cadmium and arsen
+ Solar PV panels are provided in modules easy to install	
+ Batteripakken kan benyttes til elnets balance og stabilisering	

### INSTALLATION REQUIREMENTS

- Photovoltaic
- Battery pack
- Meters
- Inverter

### ECONOMY

Typical yield	Equipment costs (excl. VAT)	Installation costs (excl. VAT)	Lifetime
Indoor battery pack 400 V 69-342 kWh 30-240 kW	366.000-1.294.000 DKK*	20-30% (proportion of equipments costs)	10-20 years
Outdoor battery pack 400 V 69-342 kWh 30-240 kW	590.000-1.707.000 DKK*	20-30% (proportion of equipments costs)	10-20 years

Danish prices in 2020

\*The price depends on the size of the battery

## Examples

- Lithium Balance A/S (provider)
- Smart Building Energy Hub

## References

[1] DTU Energy Department of Energy Conversion and Storage (2019). Whitebook – Energy storage technologies in a Danish and international perspective. Available online: <https://www.danskindustri.dk/globalassets/dokumenter-analyser-publikationer-mv/brancher-og-foreninger/di-branchefallesskaber/di-energi/ovrige-dokumenter/wec-whitebook-final-version.pdf>

[2] Power Circle, MalarEnergi, Krafttring and InnoEnergy. The potential for local energy generation in distribution network. Available online: [Http://www.innoenergy.COM/wp-content/uploads/2017/03/1702-Potential\\_for\\_loc\\_energy\\_storage\\_Final.pdf](http://www.innoenergy.COM/wp-content/uploads/2017/03/1702-Potential_for_loc_energy_storage_Final.pdf)

[3] Technological Institute, Kenergy, Lithium Balance, and Teniq. Recommendations for installation of the base ripens. Available online: <https://www.teknologisk.dk/ydelsler/anbefalinger-til-husstandsbaatterier/40140>

[4] A. Sani Hassan, L. Cipcigan, and N. Jenkins, 'Optimal tray operation for PV systems with tariff implication,' *Apl. Energy*, Vol. 203, pp.422-441, 2017. <https://www.sciencedirect.com/science/article/pii/S030626191730778X>

[5] Steen Harlitigation, Peder Backer and Svend Erik Mikkelsen (2018). Elforsk project: BIPVT-E: Development of the governance strategy for flexible power generating modules with solar cells, solar thermal, heat pump, energy absorber, and battery storage. Available online: <https://elforsk.dk/sites/elforsk.dk/files/media/dokumenter/2019-02/349-054%20Final%20report.pdf>

## 4 HEAT PUMPS WITH LOCAL ENERGY SOURCES - GENERAL INFORMATION

A heat pump exploits heat from different sources to provide heat to space heating and domestic hot water production. It consists of a heat sink system, a heat pump and a heating system.

Heat can be taken from the soil, the air, the roof or water. This requires the installation of a specific heat provider system to use the heat from the different sources.

- Soil heat installations
- Air based installation
- Roof installations
- Sea- and lake installations
- Heat pump
- Heating of space
- Domestic hot water

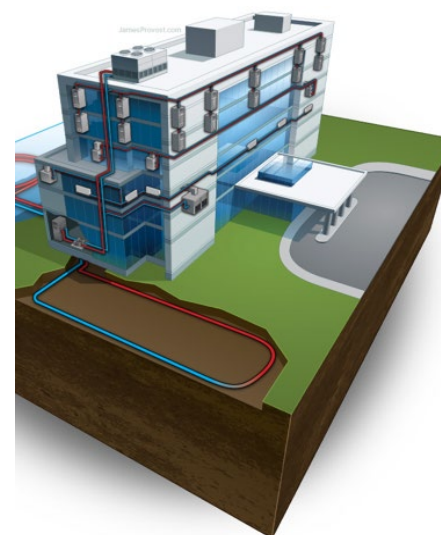

**Ground installation - horizontal.** Source: <https://jamesprovost.com/portfolio/geothermal-heat-pump>

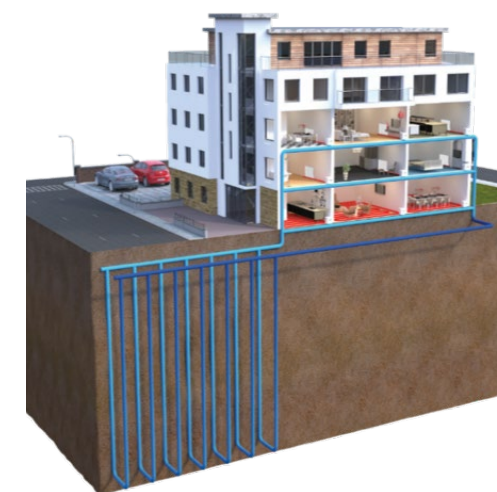

**Ground installation - vertical.** Source: <https://phpdonline.co.uk/features/ground-source-heat-pump-flats/>



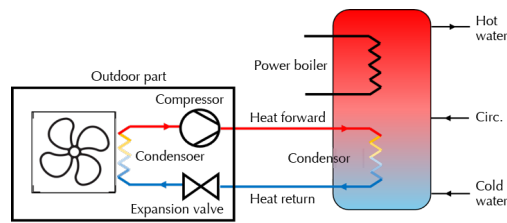

Air based installation

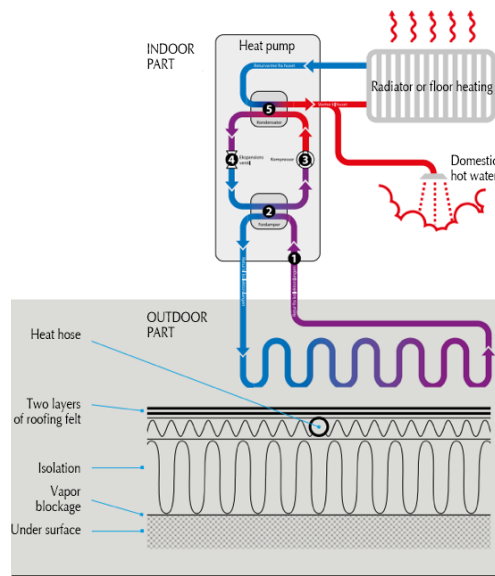

Roof installation

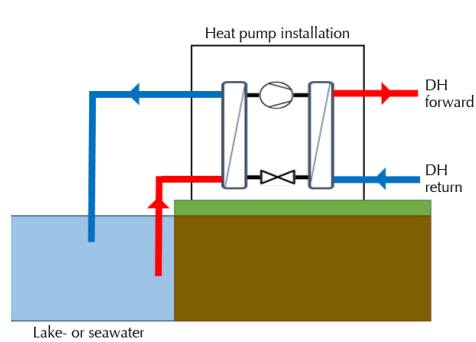

Lake- or seawater installation, water intake

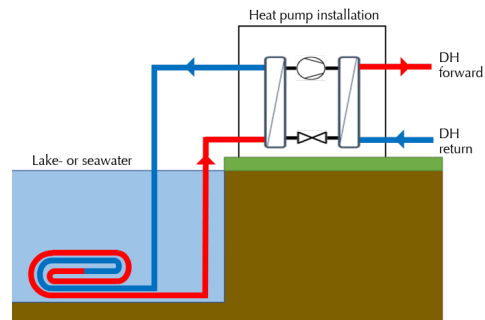

Lake- or seawater installation, closed water hose

### Technical description

Figure 18 shows a schematic drawing of a heating capacity. Circuit (1) is the heat sink system which records heat from the source. The circuit normally consists of hoses where brine is circulating, i.e. water to which anti-freezing agent is added. In an air system, it is not used for the hose, but the air is directly circulating through the evaporator.

Circuit (2) is the heat pump itself, where a refrigerant is circulated.

Circuit (3) is the heating system of the house where water is circulating. The heat pump equipment is supplied with heating to produce hot water and space heating.

The efficiency of the heat pump is defined by the COP value, which indicates the ratio between the heat produced and the amount of

electricity used to produce the heat. Figure 19 shows COP values for an air-based heating pump and a ground heat pump relative to the temperatures in a normal year at an output temperature of 55 °C.

A heat pump can be used in interaction with district heating. The next two figures show the expected heat pump COP in relation to the temperature of the heat source and the district heating temperature. In a low temperature network, a heat pump can reach a higher COP.

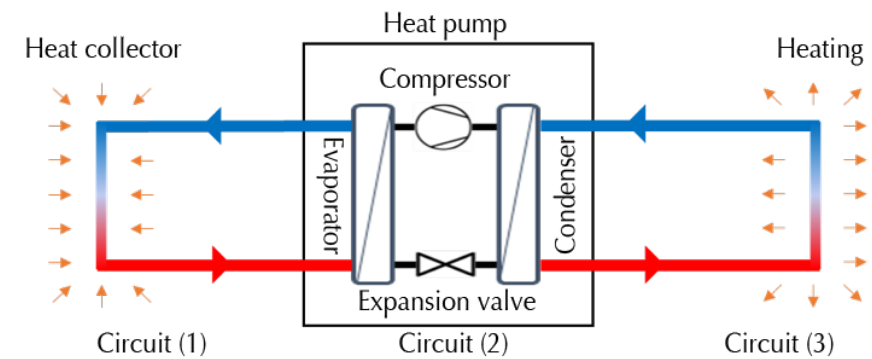

Figure 18 - Outline of a heat pump system

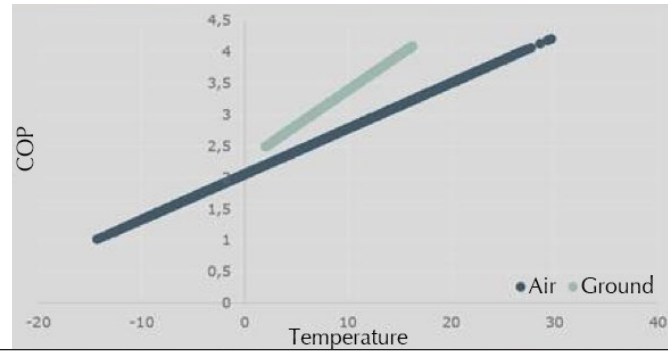

Figure 19 - Calculated COP per hour in relation to temperatures in a normal year at an output temperature of 55°C [Source: Danish Energy Agency]

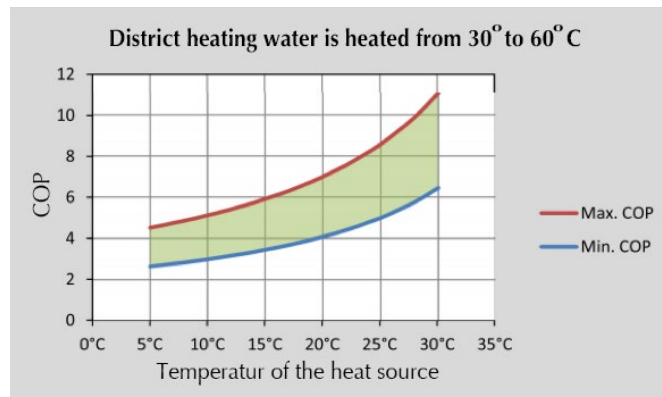

Figure 20 - Expected COP as a function of the heat source temperature [1]

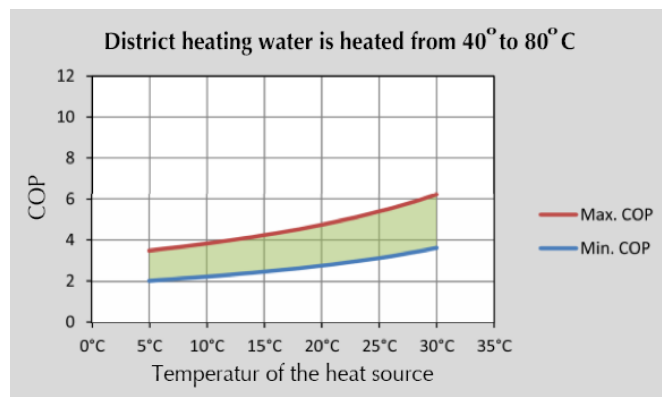

Figure 21 - Expected COP as a function of the heat source temperature [1]

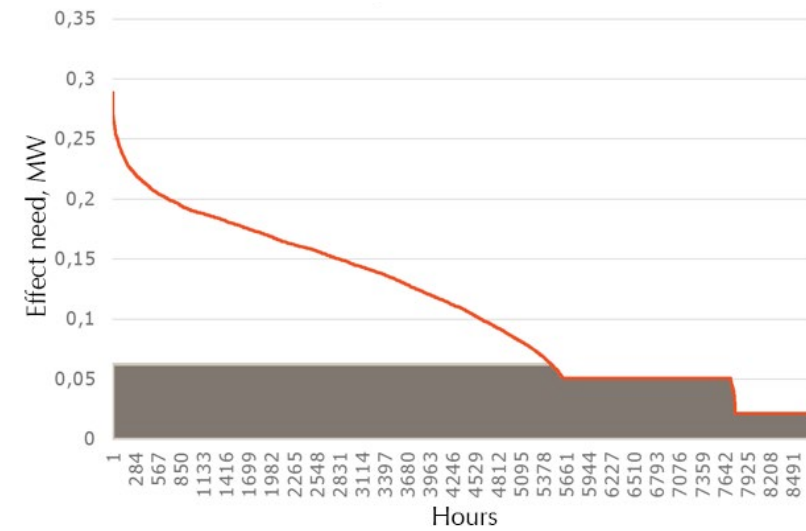

Figure 22 - Duration curve for a settlement with a heat pump (grey area)

Figure 22 shows a typical variation curve for a building where a heat pump is used to provide heat in interaction with multiple heat. As a general rule, the power needs of the heat pump are approximately 25 %.

The installation of a heat pump is to the extent that the electricity costs are low in relation to multiple heat prices. Ideally, the heating cushion can be used for a full year, covering between 50 % and 70 % of the heat demand, as shown in Figure 22.

However, the price of electricity is high and one must consider installing a photovoltaic in-

stallation to drive the heat pump. If the installation is equipped with a battery pack, a period of around 5500 hours per year (since the solar cells installation do not generate electricity in winter) may be run for a period of around hours per year. The rest of the hours are cheaper to use multiple heat in order to supply the heat needed.

If a battery pack is not installed, it can be expected that the heat pump is powered by the solar cell at about 2250 hours, as the facility cannot generate current at night.

## Properties

### Radiators/floor heating

A water-based space heater system must be connected to a heat pump, i.e. either radiators or floor heating radiators. Due to the lower inlet temperature of heat pumps, the radiators should often be larger than originally for the optimal functioning of the heat pump, otherwise lower temperature heating radiators may be installed as they optimize the heat transfer. Floor heating is also ideal for heat pumps, but more expensive [2].

### Domestic hot water

A heat pump may provide heat to hot water. A buffer tank may be installed for domestic hot water. This could reduce the need for additional electricity heaters, tapping into the hot water

storage tank and making the operation of the heat pump more energy efficient [2].

### Electric boiler

The heat pump system often has an embedded electric boiler, which can reduce the efficiency of the heat pump. In those situations, the heat pump will have a higher electricity consumption than usual. It will typically be in the coldest days or when more domestic hot water is used than normal [2].

Installation needs, economy and costs and disadvantages of individual heat pump technology are being developed in the next chapters where each technology is treated.

## References

[1] The Danish Energy Agency and Green Energy. 2017 Playbook for large heat pump projects in the multi-heat system- met. Available online: [https://ens.dk/sites/ens.dk/files/Varme/drejbog\\_for\\_store\\_varmepumper.pdf](https://ens.dk/sites/ens.dk/files/Varme/drejbog_for_store_varmepumper.pdf)

[2] Danish Energy Agency. Facts about heat pumps. Available online: <https://sparenergi.dk/forbruger/varme/varmepumpe/fakta-om-varmepumpe/>

## 4A HEAT PUMPS WITH LOCAL ENERGY SOURCES

### - SOURCE: GEOTHERMAL

A geothermal heating system uses heat from the ground to provide heat for space heating and hot water production. It consists of a heat sink system in the soil, a heat pump and a heating system. Heat hoses of the system can be positioned horizontally or vertically in the ground when a froze fluid is used to absorb heat from the ground [1]. In an urban context with access to open land, an installation with vertical energy concerns is of particular interest. A typical plant size is 50-250 kW.

- Geothermal
- Heat pumps
- Space heating
- Domestic hot water;
- Boreholes

As shown in Figure 23 and Figure 24, which are two types of geothermal systems. Heat recording system for the addition of horizontal or vertical tubes. The main characteristics are shown in the following sections.

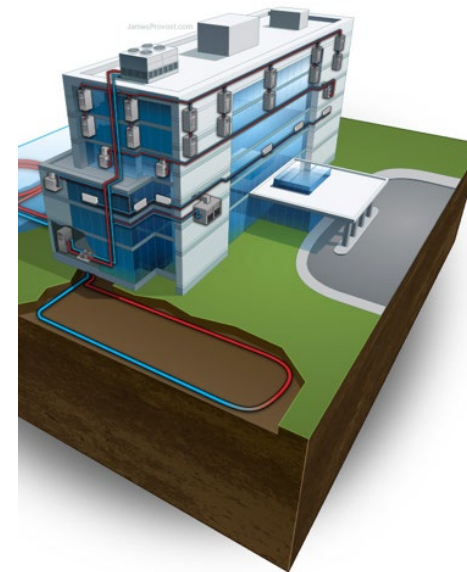

Figure 23 - Ground heating system with horizontal heating hoses. Source: <https://jamesprovost.com/portfolio/geothermal-heat.pump>

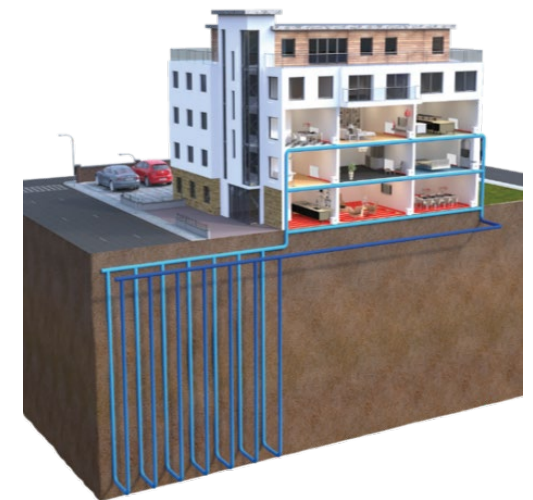

Figure 24 - Installation of the heating of the drilling Source: <https://phpdonline.co.uk/features/ground-source-heat-pump-flats/>

## Technical description

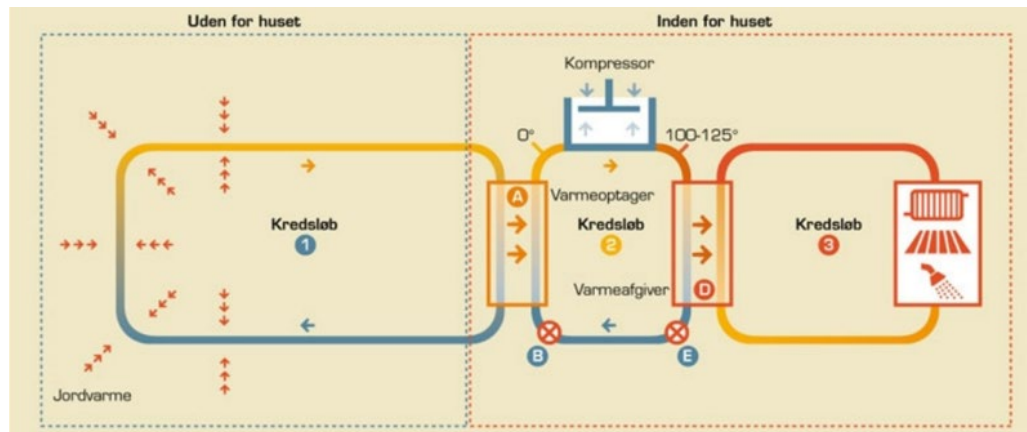

Figure 25 - Outline of a geothermal heating system (figure from IVT Natural heat) [1]

• Circuit (1) is the soil applications which capture heat from the environment. In this circuit there is a brine, which is water which has been added an anti-freezing agent. As shown in Figure 23 and Figure 24, the soil hoses may

preferably be placed vertically or horizontally.  
 • Circuit (2) is the heat pump itself, where a refrigerant is circulated.  
 • Circuit (3) is the heating system of the house where water is circulating [1].

### HORIZONTAL FACILITIES

- Typically, pipes can be positioned between 0,9-1,2 meter into the ground (but with a minimum of 0.6 m of soil cover).
- The distance requirements from others' water supplies and their own drilling or well must be 50 meter (and at least 5 m from another heat pump) [1] [3].
- Stopping distance shall be at least 0.9 m.
- Distance from neighbors: min 0.60 m
- The distance from other water or sewage pipes shall be at least 1 m, otherwise the soil hose must be isolated.
- The distance to the building shall be at least 1.5 m otherwise the soil hose must be isolated.
- Bending radius shall be 20 x exterior diameter.

- The pressure in the brine circuit is normally between 150 and 350 kPa (absolute pressure).
- Freezing agent: usually, propylene glycol and IPA sprit are used (technical sprit).
- It is usually placed one pipe at a time by a chain-excavator.
- It requires between 2-3.5 m<sup>2</sup> ground area for each m<sup>2</sup> housing.
- Heat absorption is typically 20-25 W/m in average (in wet soil f. e.g. sand and lower in clay).
- The heat uptake (and performance) is distributed over the seasons and if it is used over 2500-3000 hours, it should be possible to regenerate the soil by adding heat during the summer.

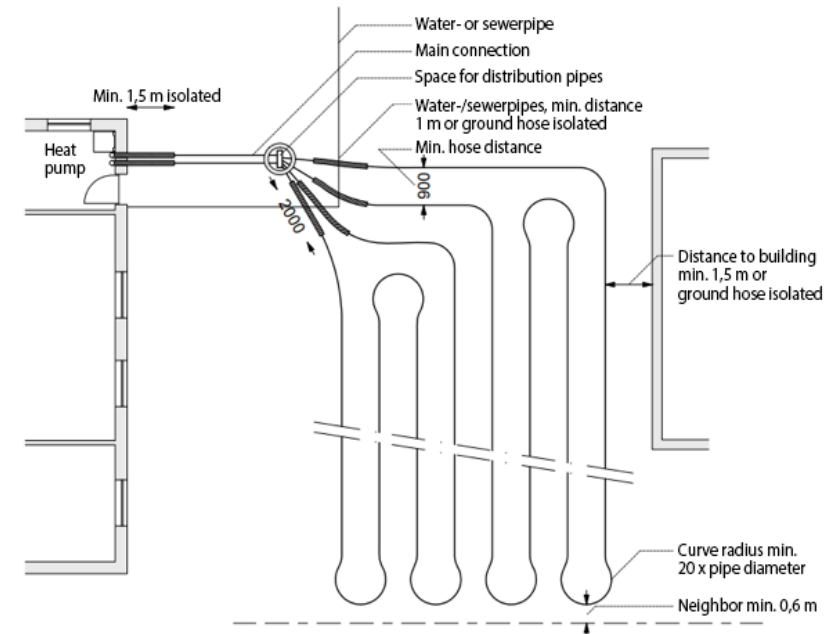

Figure 26 - Plan for locating ground hoses for horizontal installations [5]

### VERTICAL PLANTS (EARTH HEAT DRILLINGS)

- Deep geothermal plant with one or more drillings carried out with drilling equipment, and buried installations in which the deepest part of the installation goes deeper than 5 m in underground [3].
- The distance requirements to others' water supply and their own drilling or well: 300 m (and at least 50 m from other heat pump facilities) [1] [3].
- Energy collector can be performed as single U-tubes, a double U-tubes or concentric pipes (double U-tube has the highest yield).
- Heat absorption is typically 30-45 W/m (depending on soil types). If the installation is also used to provide (direct/indirect) cooling in the summer, heat uptake can be increased up to 60-70 W/m in winter.
- Distance between drillings: min. 5 m for short drillings or typically 6-7 m for long drillings.
- Drillings are usually set at between 40 m and 200 m depths. Drillings more than 250 meters deep may require permission under the Underground Resources Exploitation Act, which can be clarified in the individual case by contacting the Danish Energy Agency [1].

- In loose deposits, it is necessary to use the drill or belt assembly in order to keep the borehole open during the drilling work [1]. In the first part of drilling, a liner is put in place.
- Sealing surface drilling is most conveniently made by casting from the bottom with an appropriate bentonite/cement suspension. The heat transmission of bentonite is generally low and the sealing of the heat hoses may therefore act as an insulator impairing the heat collection. Quartz sand may be added to improve the heat transmission. The method requires the pressure strength of the ground heat pipes, which must not collapse due to the pressure during filling [1].
- To avoid the collapse of the soil heating pipes, they must be filled with liquid (water) before lowered into the well. If there is water in the hole, the pressure will increase 1 bar every 10 m. Consequently, the external pressure may be up to 20 bar in a 200 m hole.
- In order to avoid problems with soil contamination, the soil must be tested to check whether it is dense. They must be tested with water first, and if they are dense and pressure tested, you can start filling with anti-freezing agents.

## TENANT BUILDINGS

### - INSTALLATION SIZE

- Heat pump power: normal > 15 kW
- Buffer tanks/hot water tanks are often carried out as modules of 800-1000 liter
- Requirements for the temperature in the container for sanitary water 55 °C.
- Hot water temperatures must be raised to 60 °C in order to limit the risk of legionella contamination in the container.

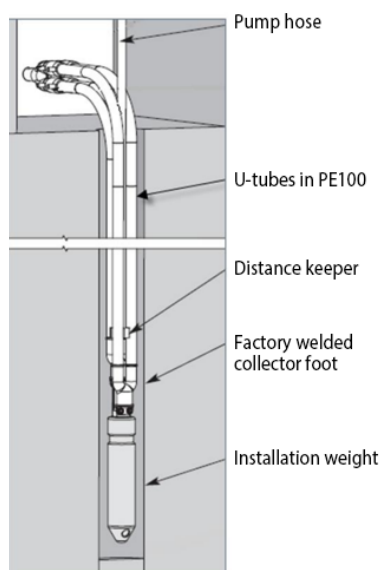

Figure 27 - Principle drawing of heat-drilling (from Rotek A/S) [1]. Energy collectors are made as double U-tubes.

All heat pumps with more than 1 kg refrigerant must be inspected at least once a year. In the case of refrigeration equipment and heat pumps, inspection and maintenance shall be carried out by a person who has been given the necessary instructions and exercises on inspection and maintenance, etc. of the type of installation concerned. In the case of facilities with more than 2.5 kg of refrigerant, the annual inspection shall be carried out by a certified technician from a registered refrigerating firm [2].

## Properties

### INSTALLATION REQUIREMENTS

- A permission is needed from the municipality using a standard form
- Check to distance to other fixtures and fittings in the soil

The soil-based heating installation must be tight and provided with [3]:

- A pressure monitoring system.
- An alarm and a safety device which in the event of a leak in the heating system stops the installation and a protocol of the supply of glycol must be made.

#### Outdoor part:

- Hoses shall be connected to the indoor part

#### Indoor part:

- The heat pump must be connected to the electrical system
- The heat pump must be connected to the heat hoses
- The heat pump must be connected to heating system

#### Drilled holes:

- Drilled holes must be regenerated. They can be used for direct cooling and for storing waste heat.

ADVANTAGES	DISADVANTAGES
+ Renewable energy	- Demands permission from the municipality
+ Can provide energy for heating as well as for domestic hot water	- Soil contamination (in case of leakage)
+ Higher efficiency than air to water heatpump installations	
HORIZONTAL INSTALLATIONS	HORIZONTAL INSTALLATION
+ Cheaper than vertical installations	- Horizontal installations demands a large area which is difficult to find in a dense city
VERTICAL INSTALLATION	VERTICAL INSTALLATION
+ Demands less area	- Deep installations are more expensive than horizontal installations
+ High temperature [6]	- Risk of ground water contamination (is not allowed to shortcut primary or secondary reservoirs)
	- Risiko af med jordvarmeslangers kollaps på grund af trykket ved opfyldning eller kollaps som følge af sten i hullet



## ECONOMY

Typical yield	Equipment costs (excl. VAT)	Installation costs (excl. VAT)	Cost of operation and service (excl. VAT)
<b>Horisontal installations</b>			
400 kW*	1.111.600 DKK*	741.000 DKK*	Fixed: 12.300 DKK/år* Variable: 3,5 DKK/MWh*
160 kW**	331.100 DKK**	331.100 DKK**	Fixed: 12.300 DKK/year** Variable: 3,5 DKK/MWh**
<b>Vertical installations</b>			
400 kW*	Approx. 2.220.000 DKK*	Approx. 1.400.000 DKK*	Fixed: 12.300 DKK/year* Variable: 3,5 DKK/MWh*
160 kW**	Approx. 660.000 DKK**	Approx. 660.000 DKK**	Fixed: 12.300 DKK/year** Variable: 3,5 DKK/MWh**

**Danish prices in 2020**

*In the Technology Catalogue concerning individual heating the following directional data is included. The figures refer to a building with about 110 smaller apartments. The price level per installed kW can also be used for a larger installation serving buildings of 450 flats.*

*\* data for an existing building: Area: 8.000 m. 2, heat consumption: 960 MWh/year, peak load (heat): 400 kW*

*\*\* data for a new building: Area: 8.000 m. 2, heat consumption: 320 MWh/year, peak load (heat): 160 kW*

## Suppliers

- DVI
- Thermia
- Thermonova
- Viessmann

## References

[1] B., Villumsen (COWI A/S) 2008. Soil-based heating installations. Technologies and risks to soil and groundwater contamination. Available online: <https://www2.mst.dk/Udgiv/publikationer/2008/978-87-7052-780-4/pdf/978-87-7052-781-1.pdf>

[2] The Ministry of Employment. 2007 Order on the use of pressure equipment. Available online: <https://www.retsinformation.dk/Forms/R0710.aspx?id=31045>

[3] Danish Environmental Protection Agency. Ministry of Environment and Food. 2017 Order on heating systems. Available online: <https://www.retsinformation.dk/Forms/R0710.aspx?id=186984>

[4] Danish heat pump Industry A/S. Guide to burial of soil landings. Available online: [https://dewa-vvs.dk/CustomerData/Files/Folders/4-pdf/157\\_vejledning-nedgravning-af-jordslanger.pdf](https://dewa-vvs.dk/CustomerData/Files/Folders/4-pdf/157_vejledning-nedgravning-af-jordslanger.pdf)

[5] The Danish Energy Agency and Energinet. 2016 Technology catalogue for individual heating systems. Available online: <https://ens.dk/service/fremskrivninger-analyser-modeller/teknologikataloger/teknologikatalog-individuelle>

[6] The Danish Energy Agency and Green Energy 2017. Drejebog til store varmepumpeprojekter i fjernvarmesystemet. Available online: [https://ens.dk/sites/ens.dk/files/Varme/drejebog\\_for\\_store\\_varmepumper.pdf](https://ens.dk/sites/ens.dk/files/Varme/drejebog_for_store_varmepumper.pdf)

## 4B HEAT PUMPS WITH LOCAL ENERGY SOURCES

### - SOURCE: LAKE/SEA WATER

A heat pump facility may use sea or lake water as a source to provide heat to space heating or domestic hot water production. The system works, like a geothermal heating system, but the hose is located on the sea or sea bed. Alternatively, it is possible to pump the sea water easily through an alternate in order to gain heat.

A typical size from 50 kW (hoses) to 2 MW (with sea water intake).

- Lake/sea water heating
- Heat pumps
- Space heating
- Domestic hot water;

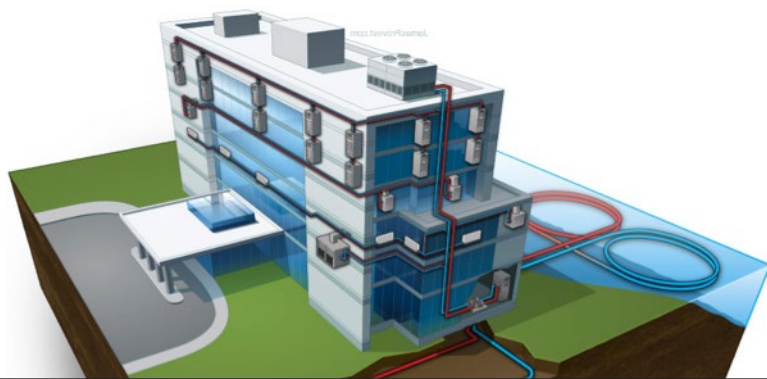

Figure 28 - Lake or sea water installations with hoses placed at the bottom.  
Source: <https://jamesprovost.com/portfolio/geothermal-heat-pump>

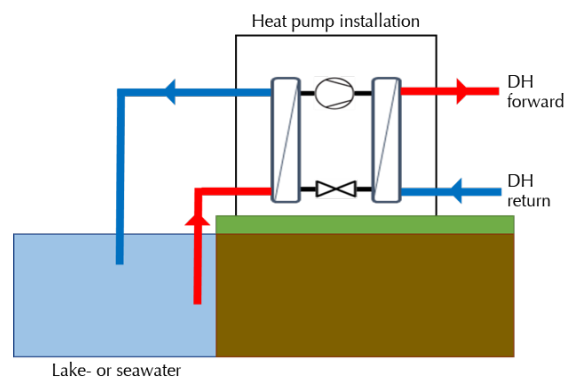

Figure 29 - Outline of a lake- or seawater installation with intake of water

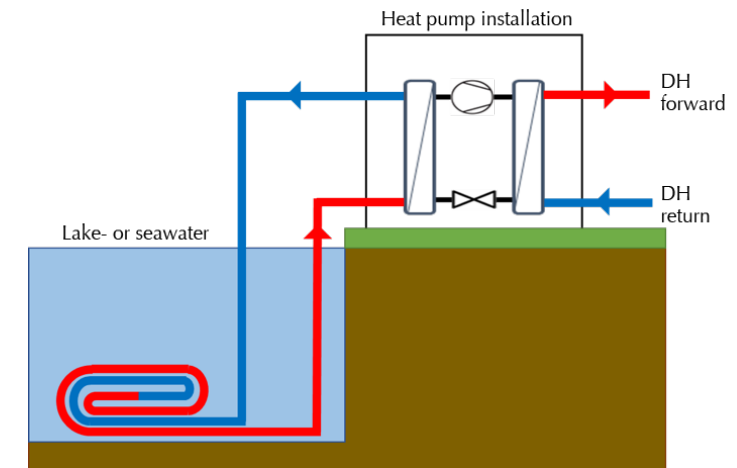

Figure 30 - Outline of a lake- or seawater installation with intake through hoses on the lake/sea bed

## Technical description

- All heat pumps with more than 1 kg refrigerant must be inspected at least once a year. Maintenance and servicing of the cooling equipment and heat pumps shall be carried out by a person in possession of the necessary instructions, servicing and maintenance exercises. In the case of plants with a more than 2.5 kg of refrigerant, the annual inspection shall be carried out by a certified technician from a registered refrigeration firm [5].
- The hoses placed on the lake/sea bed must be resistant to rust and tear (plastic or stainless steel) and must be robust.
- The hoses must be attached (fixed) to the lake or seabed.

## SEA WATER FACILITIES

- Due to low seawater temperatures in winter (especially in the Baltic Sea), a traditional plate heat exchanger can quickly freeze. Several installations with drizzling evaporators can be installed which allow a certain freezing of ice [1].
- If there is a possibility of low water intakes from more than one depth, this can be exploited. The heat pump can use hot surface water in the summer time, and to switch to water from greater depth in winter when there is a risk of icing [1].
- The seawater must be analyzed to allow for the selection of the right grain resistant materials [1].
- It is important to identify flow conditions, temperatures, flora and fauna so that the most appropriate location for water intake can be found [1].
- Biofouling mainly consists of mussels, acorns/ sea-tulips and algae, and it should be ensured that it is not possible to establish a grip as this will both result in lower efficiency and increase in the grain. Biofouling may be prevented or varied by means of filtration, regular treatment, use of chemistry, high flow rates or any periodic warming of the surfaces to high temperatures [1].
- The installation may be equipped with two alternative heat exchangers, so that one can be cleaned. Due to animals, seaweed, garbage and other things in water the efficiency of the heat exchanger quickly. If the installation has only one heat exchanger, cleaning operations will pause the operations.

## LAKE WATER FACILITIES

- Usually fresh water is allowed to cool to 2° C before it is passed back to the water system [1].
- A static lake holds the temperature throughout the year. From the early spring, it will be possible to develop monolayer sharing where the top water is heated by the sun and the air temperature, while the lower water of the lake only in a very limited extent alters temperature. Water item temperature could change from 17-18° C in early autumn to 4° C in early spring [1]
- It is important to have specific measurements of temperature variations in the lake over the wine year to assess the temperature of the lake in relation to the heat pump operating period from November to April [1].
- Another important element is to highlight the impact of cold water on the lake's flora and fauna in the calculations of water volumes and temperature differences [1].

## TENANT BUILDINGS

### - INSTALLATION SIZE:

- Heat pump power: normal > 15 kW
- Buffer tanks/hot water tanks are often carried out as modules of 800-1 000 l.
- Requirements for the temperature in the container for sanitary water 55 °C.
- The water temperature must be raised to 60 °C to limit the risk of Legionella in the container.

## Properties

- The plants using seawater as heat source are usually installed in large buildings where they are used for heat production in decentral district heating plants.
- The installation can be turned and also be used for cooling in summer (including free cooling in spring and autumn).

## INSTALLATION REQUIREMENTS

- Heat hoses/pump connections
- Heat pump connection
- Connection to multiple heat networks or buildings (space heating and sanitary);
- Pipe connection to seawater with filter facilities

ADVANTAGES	DISADVANTAGES
+ Renewable energy	- Demands permission from the municipality concerning environmental aspects (temperature, nature conservation and eventual pollution)
+ Accessible to a great extent in larger Danish cities often located close to water	- Permission from harbour or water authorities
+ A sea based installation is cheap and easy to build	- The water intake must be placed at a certain depth to avoid problems with icing in the coldest periods
+ Large facilities (sea water)	- Bio growth in heat exchangers and other components demand frequent cleaning
+ The case handling by authorities is much easier than in cases involving sweat water	- Pollution in case of leakage
+ Utilties have experience with sea water exchange from steam condensators	- Moving pollution from one locality to another
	- When using sea water the area must be big enough to limit the influence on teperatures

## ENVIRONMENTAL ASPECTS

### The EIA Order

The project must be screened for the EIA obligations, as a heat pump would be covered by paragraph 3 of Annex 2 to the decision, energy industry (a) Industrial installations for the production of electricity, steam and hot water. Possibly also of Annex 2, 10 concerning Infrastructure projects (a) Construction works in industrial areas for industrial purposes, (f) Construction of waterways not covered by Annex 1, channel construction and management of water courses or (j) Construction of long-distance water lines.

### Environmental Protection Act

If the project is covered by Annex 2 of the order on approval (from 2017), list point G 201 on power generating plants, heat generators, gas turbine installations and engines with a total thermal input between 5 and 50 MW, the project may need to have an environmental permit in accordance with Chapter 5 of the Environmental Protection Act. If the installation is environmentally approved, discharge of water to the recipient is controlled as part of the environmental permit. If the installation is not subject to environmental approval, a discharge for discharge shall be made in accordance with Section 28 of Chapter 4 of the Environmental Protection Act, as return water will normally be treated as waste water. In addition, other elements such as noise, extraction requirements from ammonia, etc. will be included in the environmental permit.

### Water shed management plans

It must be ensured that any industrial heat exploitation does not conflict with the target sets for groundwater and surface water systems.

### The Nature Conservation Act

If a lake over 100 m<sup>2</sup> or a water course is used as a heat source, or if areas protected by Section 3 are otherwise affected, the project must have a derogation under Section 3 of the Nature Conservation Act (NCA) (Nature Conservation Act, 2017). In addition, there may be legislation and regulations linked to areas that need to be taken into account by concrete plans for the establishment of an installation.

### The Habitats Order

If the project is likely to affect a Natura 2000 area, an initial essential assessment or an impact assessment must be made according to the rules laid down in the Habitats Order (the Habitats Order, 2016).

## ECONOMY

Typical yield	Equipment costs (excl. VAT)	Installation costs (excl. VAT)	Cost of operation and service (excl. VAT)
- kW*	- DKK*	- DKK*	Fixed: - DKK/year* Variable: - DKK/MWh*

\* Individual specifics: the installation costs are dependent of a number of factors and specific demands.

## Examples

### SUPPLIERS

- Johnson Controls (supplier)
- Aarhus Ø (installations)
- AVC South port (installations)
- Home shop (installations)

## References

[1] The Danish Energy Agency and Green Energy 2017. Drejebog til store varmepumpeprojekter i fjernvarmesystemet. Available online: [https://ens.dk/sites/ens.dk/files/Varme/drejebog\\_for\\_](https://ens.dk/sites/ens.dk/files/Varme/drejebog_for_)

## 4C HEAT PUMPS WITH LOCAL ENERGY SOURCES - SOURCE: AIR

An air-to-water heat pump installation collects energy from the outdoor air and delivers it to a water-based heating system. It can be used for both space heating and the production of domestic hot water. Often it will be complemented with a electric boiler to supply heat in peak load periods. The heat pump will be build in modules of 10 to 250 kW.

- Air-to-water heating installations
- Heat pump
- Space heating
- Domestic hot water



Figure 31 - the outdoor part of an air-to-water heat pump. The unit can be build as cascades to ensure larger effect. Source: <https://dansk-energi-center.dk/varmepumper/store-varmepumper>

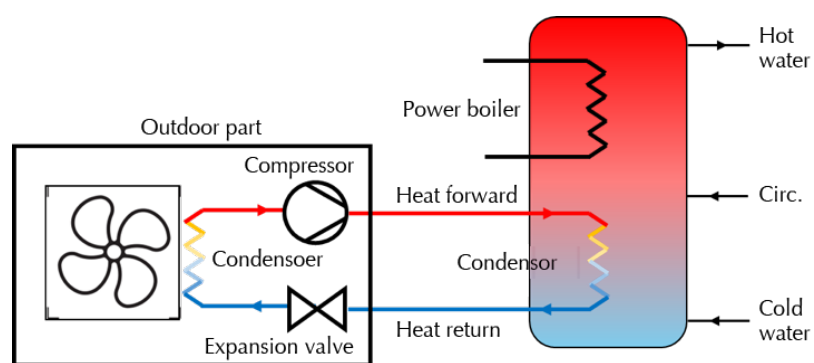

Figure 32 - Outline of an air-to-water heat pump

## Technical description

### AIR-WATER HEAT PUMP

- All heat pumps with more than 1 kg of refrigerant must be inspected at least once a year. The inspection and maintenance, etc. of the refrigeration equipment and heat pumps must be carried out by a person who has been given the necessary instructions, inspection and servicing exercises. In the case of plants with more than 2.5 kg of refrigerant, the annual inspection shall be carried out by a certified technician from a registered refrigeration firm [3].
- Avoid to enclose the heat pump: The heat pump produces heat by 'taking' it from the outside air. Therefore, it is essential for the performance of the heat pump that it is not enclosed. First, it must be able to absorb air without hindrance - it does so on the reverse side. Secondly, it must be capable of returning the air - it does so on the front side. If the heat pump is too enclosed the flow of air will be prevented and the pump will provide less [1].
- Outdoor air/water installation should only be erected where noise does not give rise to problems [4]. Proposal: 5-10 m proximity from neighbors, otherwise noise protection shields must be installed.
- The outdoor part may be installed on a flat roof in order to avoid noise problems.

### TENANT BUILDINGS - INSTALLATION SIZE

- Heat pump power: normal > 15 kW
- Buffer tanks/hot water tanks are often carried out as modules of 800-1000 liter.
- Requirements for the temperature in the water heater shall keep 55° C (up to 60-65° C (to avoid Legionella formation).

### SPACE FOR AIR INTAKE

- An air heat pump requires an air surface area of approximately 0.2 m<sup>2</sup>/kW.
- The outdoor part can be placed on the roof when there is space for the installation and the roof can carry the weight.
- In the case of large-scale installations, there is also the possibility of installations at ground level where a platform is built for the outdoor part. The installation should consider a system for the removal of water/ice from the exchanger and ends on the ground.
- Hot water temperature shall be raised to 60° C to limit the risk of Legionella contamination of the container.

## Properties

### ENERGY FLEXIBILITY

The COP of heat pumps decreases in cold periods and decreases in energy flexibility. In the others periods may use the heating capacity of

the building to store heat. This means that the heat pump can be switched off for a few hours.



ADVANTAGES	DISADVANTAGES
+ Renewable energy	- Effectiveness varies in relation to the outdoor temperature
+ Does not demand a permission from the municipality but must comply with the construction codes	- Lower effectiveness than a soil based heat pump
+ Can provide heat for space heating and for domestic hot water	- Risk of complaints due to the noise level
+ Cheaper than a soil based heat pump	- May require an upgrade of the power grid

### INSTALLATION REQUIREMENTS

- Eventual installation requirements may be set by the municipality (distance from neighbors due to noise)

### ECONOMY

Typical yield	Equipment costs (excl. VAT)	Installation costs (excl. VAT)	Cost of operation and service (excl. VAT)
400 kW*	734.300 DKK*	314.700 DKK*	Fixed: 12.300 DKK/year* Variable: 3,5 DKK/MWh*
160 kW**	317.000 DKK**	211.300 DKK**	Fixed: 12.300 DKK/year** Variable: 3,5 DKK/MWh**

#### Danish prices in 2020

In the Technology Catalogue concerning individual heating installations the following directional data are provided. The number concerns a building with approx. 110 smaller apartments. The price level per installed kW may also be used for larger installations, than comprise of 450 apartments.

\* Data for an existing building: Space: 8.000 m<sup>2</sup>, Heat consumption: 960 MWh/year, Peak load (heat): 400 kW

\*\* Data for a new building: Space: 8.000 m<sup>2</sup>, Heat consumption: 320 MWh/year, Peak load (heat): 160 kW

## Examples

### SUPPLIERS

- DVI
- Thermia
- Thermonova
- Viessmann
- Vølund
- Nibe

### INSTALLATIONS

Often found on smaller buildings in the country side.

## References

[1] Energistyrelsen og Grøn Energi. 2017. Drejebog til store varmepumpeprojekter i fjernvarmesystemet. Tilgængelig online: [https://ens.dk/sites/ens.dk/files/Varme/drejebog\\_for\\_store\\_varmepumper.pdf](https://ens.dk/sites/ens.dk/files/Varme/drejebog_for_store_varmepumper.pdf)

## 4D HEAT PUMPS WITH LOCAL ENERGY SOURCES - SOURCE: ROOF SURFACES

A roof panel makes use of heat from the surface of the tags. The heat hose shall be placed on the surface of the tags and take energy from the environment. The hoses are connected to a heat pump providing heating for space heating and domestic hot water. Typical size is 15-40 kW (roof area 400-1000 m<sup>2</sup>).

- Roof construction
- Heat pumps
- Space heating
- Domestic hot water;
- Solar collector



Figure 33 - The hoses for heat pumps in the roof construction [1]

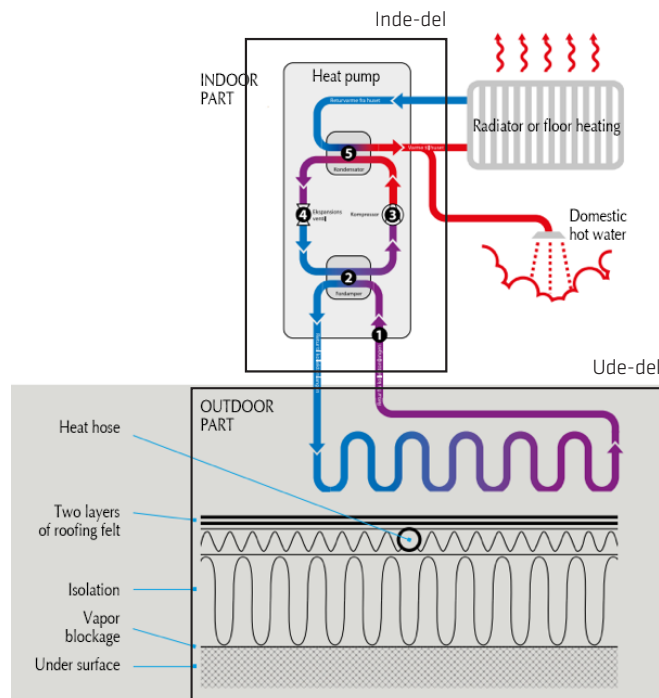

Figur 34 - Roof construction for installation. Sections of the roof and outline of the heat pump installation plan [2].

## Technical description

### ROOF INSTALLATIONS

- All heat pumps with a refrigerant load greater than 1 kg must be inspected at least once a year. Maintenance and servicing of the cooling equipment and heat pumps shall be carried out by a person in possession of the necessary instructions, servicing and maintenance exercises. In the case of plants with a load greater than 2.5 kg of refrigerant, the annual inspection shall be carried out by a certified person from a recognized refrigeration firm [5].
- The site is most suitable for flat roofs, as it is easier to install.
- In the case of a straddle roof, it shall not be required to take any roof on the south. The hose transfers most heat when it rains and is windy because the air/rainwater is continuously replaced and the heat energy is constantly transferred to the roof [1]. The installation also takes up energy from the sun, and some heat lost from the roof of the building.
- The plant imposes significant requirements on insulation of the building and a vapor blockage which implies the involvement of professionals [1]. As heat receivers are placed on top of an insulation layer the heat capacity is low. The objective of the installation is to take heat from the environment.
- In multi storage building, the area of the roof may not be sufficient to deliver the entire energy consumption of the building. In this case another source must be added to the heating system.
- On average, there will be 170 hours per year, where it is too cold for the installation to heat the building up. there is a need to have another heating option. For example, a small geothermal or an electric thermal boiler [1].

- To be renovated when installing the attachment and strengthening it in order to carry the mass of the equipment.
- Heat absorption is typically 25-33 W/m<sup>2</sup> [2].
- The annual efficiency of the COP is approximately 3.9 [2].
- Uncertainty about performance due to outdoor temperatures, solar radiation and wind.

### TENANT BUILDINGS - INSTALLATION SIZE

- Heat pump power: normal > 15 kW
- Buffer tanks/hot water tanks are often carried out as modules of 800-1000 liter.
- Requirements for the temperature in the water heater shall keep 55° C (up to 60-65° C for Legionella disinfection).

## Properties

### Electric boiler

The heat pump system often has an embedded electricity boiler than is turned on when the heat pump cannot provide enough heat. In those situations, the heat pump will have a higher electricity consumption than usual. It will typically be in the coldest days or when more domestic hot water is used than normal [6].

### Alternative solution

As an alternative solution, an installation using thermal energy catching panels can be mounted on the roof. This solution does not integrate the hoses in the roof structure [4].

ADVANTAGES	DISADVANTAGES
+ Renewable energy	- May demand an upgrade of the power grid
+ Can provide heat for space heating and for domestic hot water	- The roof must be renovated
+ Higher efficiency than air-to-water heat pumps	- Installations on the roof can reduce heat absorption potential
+ Does not demand permission from the municipality	- Solar PV or solar heat can not be installed

## INSTALLATION REQUIREMENTS

### Outdoor part

- Heat hoses must be connected to the indoor part

### Indoor part

- The heat pump must be connected to the electricity system and the heat hoses
- The heat pump must be connected to the heating system

## ECONOMY

Typical yield	Equipment costs (excl. VAT)	Installation costs (excl. VAT)	Cost of operation and service (excl. VAT)
160 kW*	Heat pump: Approx. 750,000 DKK* Energy collector roof (approx. 4000 m <sup>2</sup> ): Approx. 1,000,000 DKK*	Approx. 350.000 DKK*	Approx. 1%*

### Danish prices in 2020

The following directional data are provided in the Technology Catalogue for individual heating systems. The figures refer to a property with about 110 smaller apartments. The price level per installed kW can also be used for a larger installation serving buildings with 450 flats.

\* data for a new building: Area: 8.000 m. 2, heat consumption: 320 MWh/year, peak load (heat): 160 kW

## Examples

### SUPPLIERS

- Icopal Danmark A/S

### INSTALLATIONS

- Assens Kommune energitag

## References

[1] Roof-design heat pump description. Available online: <https://www.idenyt.dk/huset/tag/taget-kan-varme-hele-huset-op-via-varmepumpen/>

[2] ICOPAL energy tag 2012. Energy economic heating from the roof. Available online: <http://www.icopal.dk/~media/UploadFolder/Products/DK/IcopalDK/ProductLibrary/Bitumen%20Membranes/Energitag/4065Energitag0312.pdf>

[3] The Danish Energy Agency and Green Energy. 2017 Playbook for large heat pump projects in the multi-heat system- met. Available online: [https://ens.dk/sites/ens.dk/files/Varme/drejbog\\_for\\_store-varmepumper.pdf](https://ens.dk/sites/ens.dk/files/Varme/drejbog_for_store-varmepumper.pdf)

[4] Solar Venti. Thermal energy for geothermal energy. Available online: <https://www.solarventi.dk/hvorfor-luftsolfangere/energifangere-til-jordvarme/>

## 5 BUFFER HEAT TANKS FOR SMOOTHING PEAK LOADS

Heat can be stored during periods of low energy needs and then used during peak load periods. The walls of the buildings and the heating system can in themselves store heat for up to several hours, a characteristic which can be taken into account in heat system.

In addition, heat may be stored in a container in the form of hot water or in the buildings and their facilities for space heating, where the heat capacity is expected to be between a few hours to a day. The hot water storage tank is typically 800 to 2500 liters, and can be combined with heavy containers. Buffer tanks shall typically be operated from more than one container of modules of 100 to 1000 liter per module.

In order to obtain longer storage periods, a pond heat storage can be built or alternatively a large accumulation tank can be established. A common size of a pond heat storage is between 50 m<sup>3</sup> and 100.000 m<sup>3</sup>. Large pond storages facilities have been built (approximately 200.000 m<sup>3</sup>) in Denmark and explorations have made for larger pond storages (up to 600.000 m<sup>3</sup>). A large storage tank may be 500-5.000 m<sup>3</sup> (up to 10.000 m<sup>3</sup>).

- Buffer tanks
- Peak load levelling
- Heat displacement
- Pond heat storage
- Accumulation tank

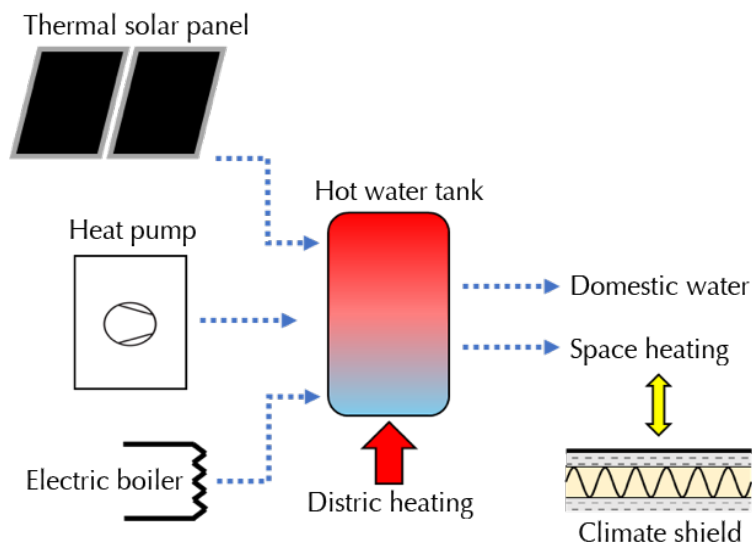

Figure 35 - Outline of a storage system for electricity and heat

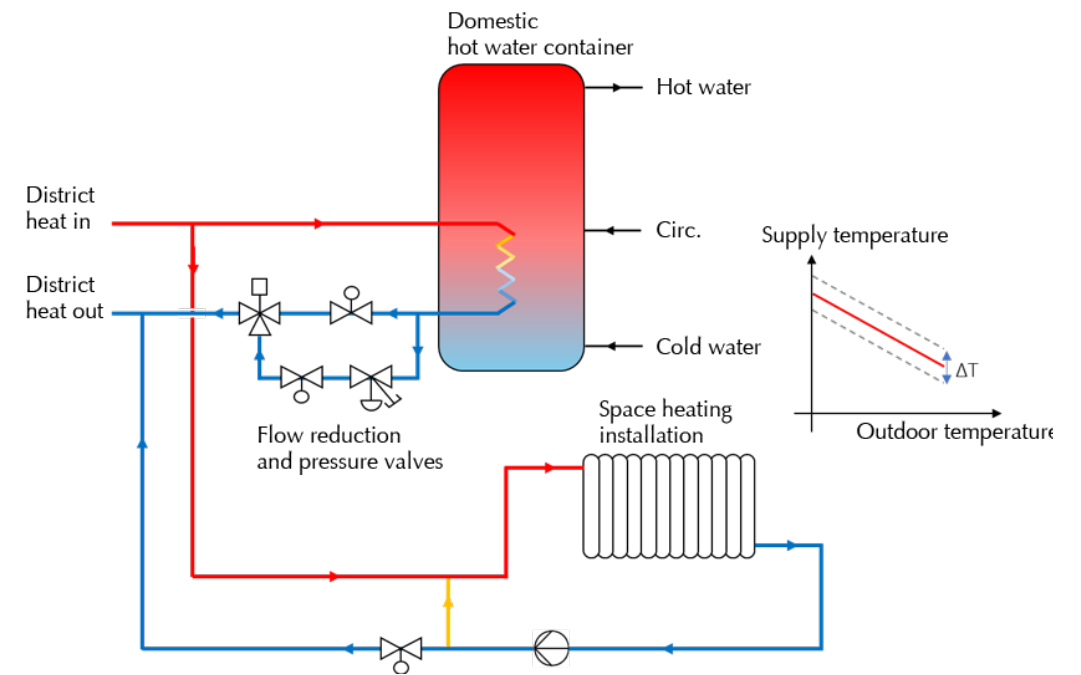

Figure 36 - Outline of space heating and hot water storage

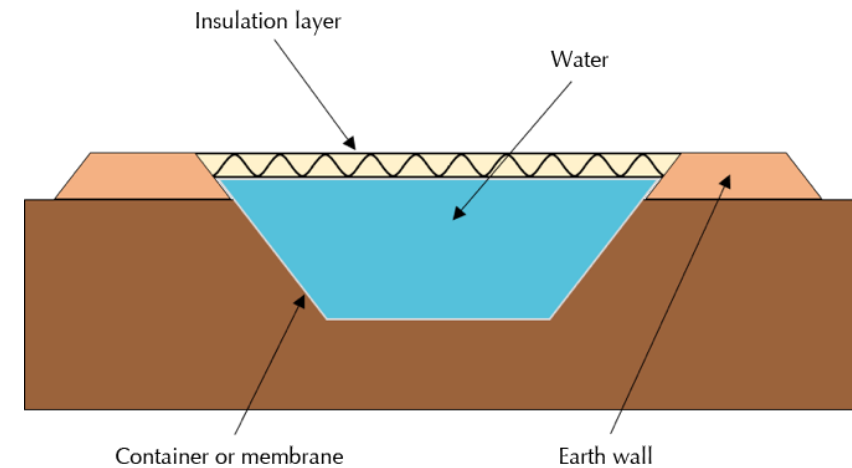

Figure 37 - Outline of a heat storage pond

## Technical description

### DOMESTIC HOT WATER

- Figure 35 shows how heat storage can be performed in a hot water heater. The container is used to store hot water when the needs of the building are low and supply hot water during peak load periods. In this way, the district heating supply can provide a lower effect in the peak load period and needs less grid capacity. A bypass can be used to install a flow limitation valve in the system which controls the supply from the district heating and hereby optimize the heat supply to the container. When energy needs in the building are particularly high, the bypass can be closed and so the flow from the district heating is not limited.
- The water temperature in the container shall be high enough to provide hot water at 55° C.
- Hot water temperatures shall be raised to 60° C to limit the risk of Legionella in the container.
- The water temperature in the circulation tube shall be at least 50° C.
- The tank may also be connected to other heat sources such as a heat pump, an electricity cartridge or the solar collector. Thanks to storage energy storage, domestic hot water can be produced using alternative sources when it is cheaper than using multiple heat

### SPACE HEATING

- Figure 36 also shows the space heating system. It can use the mass of the building to store energy.
- Room temperature can be raised and lowered within a limit (e.g.  $\pm 1^\circ \text{C}$ ) over 4-6 hours.
- The system can prioritize production of hot water during peak load periods. The outlet temperature can be controlled centrally to raise or lower the temperature of the space heating system.
- A floor heating system can contribute with a higher storage potential than a radiator facility, as the floor heat has a higher thermal mass.

### DOMESTIC HOT WATER

- Figure 37 shows the outline of a heat storage pond where hot water can be stored for several days.
- The bottom and sides of the pond are covered with a membrane, while at the peak a layer of insulation is used to reduce heat losses. A vapor blockage is used to protect the insulation from humidity.
- Warm water is stored at about 90° C [4].
- The sort of storage system has been carried out to increase energy flexibility in a district heating grid.
- The economy of a heat storage pond is of relevance when the system is used as a day and week storage and only to a very limited extent for storage over several months [5].
- Heat loss may be lower than 10 % after a year in service.

### LARGE ACCUMULATIVE TANK

- Large accumulation tanks are usually constructed in stainless steel.
- Hot water is stored at about 90° C. by connecting accumulation tanks with heat pumps or solar thermal heaters, hot water is reduced by 70-80° C [4].
- A normal storage period is between a few hours up to a few weeks, but in smaller district heating grids large accumulation tank can be used as a seasonal storage facility [4].

## Properties

Figure 38 shows a consumption profile of hot use water from measurement data from 7 different houses and is compared to Danish and European standards. Two peak periods can be considered in

working days, the first morning between 6 and 8, and the second one in the evening between 17 and 19, when the residents are expected to take a bath.

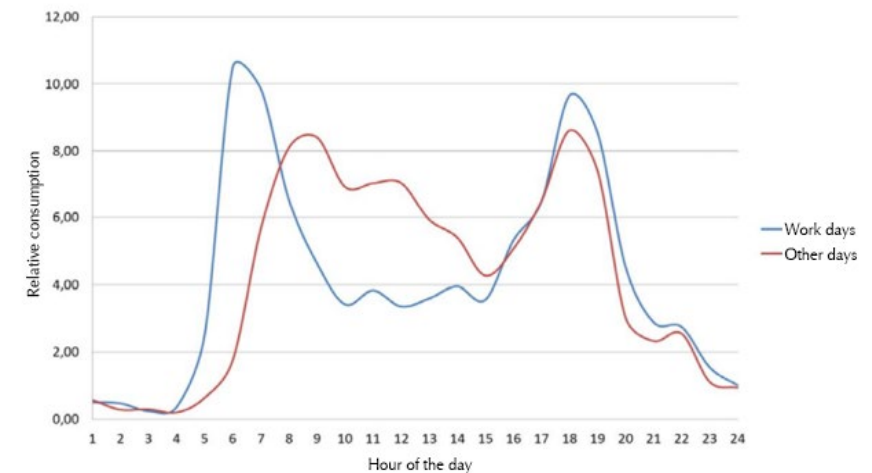

Figure 38 - Typical consumption profile of cold and hot water in a multi-family house on a day [2]



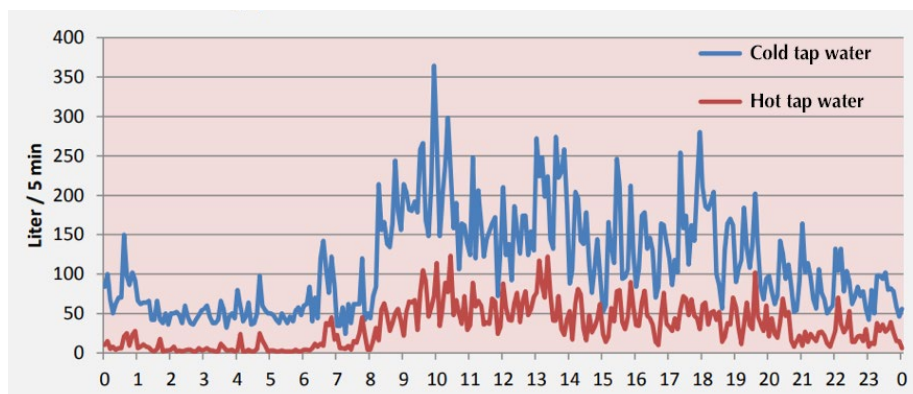

Figure 39 - Typical consumption profile of cold and hot water in a multi-family house on a day [2]

Similarly, graph 39 shows the consumption profile of a multi-dwelling house (100 apartments). The profile is more flat, with many peaks during the day when residents are in a bath.

The integration of a hot water storage tank may be used to smoothen peak loads. When heat demand is low, it is possible to save energy used afterwards during peak load periods.

If a hot water storage tank is installed in domestic hot water, the multiple heat network may deliver a more constant load on a day without high peak load. Peak smoothing can help

to lower temperature and delta temperature in multi-thermal supply, with fewer problems with capacity in the wiring.

Large accumulation tanks and steam storage may be used in periods of high consumption in the course of the winter when the outdoor temperature is lower. An accumulation tank may be charged when outdoor temperature is higher and heat consumption is lower. Afterwards, hot water may be used for a different time in order to obtain weather-related conditions.

ADVANTAGES	DISADVANTAGES
+ Smart-grid options	- Demands a fine tuning after installation
+ Lower impact of the district heating system	- A dam water storage demands a large area
+ A larger proportion of the heat can be covered with focus on base and midd loads	- A dam water storage includes a huge investment
+ Higher energiflexibility in borth shorter and longer periods.	- Risk concerning the building of the system due to leakages in the membrane
+ A dam water installation is a cost effective solution concerning larger heat storage facilities	- High loss of heat from a accumulation tank (heat losses are higher than in a accumulation tank than in a dam storage compared to volume)
+ A large accumulation tank involves lower investments than a dam water storage	

## ECONOMY

Typical yield	Equipment costs (excl. VAT)	Installation costs (excl. VAT)	Cost of operation and service (excl. VAT)
Buffer tank 0.5-2 m <sup>3</sup>	Approx. 12.000-15.000 DKK/m <sup>3</sup>	Approx. 20-30% DKK (proportion to total costs)	Approx. 1-2 DKK/year (proportion to total costs)
Large accumulation tanks [4] (50-10.000 m <sup>3</sup> )	Approx. 2.800-550 DKK/m <sup>3</sup> *	Approx. 1.200-200 DKK/m <sup>3</sup> *	Approx. 3,5 DKK/m <sup>3</sup> /year
Dam heat storage [4] (50.000-500.000 m <sup>3</sup> )	Approx. 270-150 DKK/m <sup>3</sup> *	Approx. 90-50 DKK/m <sup>3</sup> *	Approx. 1,5 DKK/m <sup>3</sup> /year

### Danish prices in 2020

\* The system's size affects the costs

## INSTALLATION REQUIREMENTS

- Hot water storage tank
- Flow limitation valve
- Control and valves

## Examples

### SUPPLIERS

- Frese ventiler

### INSTALLATIONS

- Trigeparken i Aarhus [3]

## References

- [1] Jensen, R.L., Nørgaard, J., Daniels, O., & June, R.O. (2011). Person og forbrugsprofiler: bygningsintegreret energiforsyning. Aalborg: Aalborg Universitet. Institut for Byggeri og Anlæg. (DCE Technical Reports; Nr. 69).
- [2] NYKVIST, A. (2012). Värmeåtervinning ur spillvatten i befintliga flerbostadshus.
- [3] Ready project website. Available online: <http://www.smartcity-ready.eu/>
- [4] The Danish Energy Agency and Energinet 2018. Technology catalogue for energy storage. Available online: <https://ens.dk/service/fremskrivninger-analyser-modeller/teknologikataloger/teknologikatalog-energilagring>
- [5] Vestegnens Kraftvarmeselskab I/S (VEKS) og Høje Taastrup Fjernvarme a.m.b.a. 2017. Varmelager i Høje Taastrup. Available online: <https://www.htk.dk/~media/ESDH/committees/22/2488/30909.ashx>

## 6 COMBINATION OF ELECTRICITY BASED TRANSPORT AND USE OF BATTERIES FOR FLEXIBILITY

It is expected that, due to the green transition, more electric cars will connect to the electricity grid in the early days. The higher number of electric vehicles will increase electricity consumption and therefore smart charging is to be carried out in order to reduce the risk of possible options with the electricity supply compared to a higher point of the load. In addition, batteries can be used to balance the grid and supply power during peak periods. The battery of an electric car is typically 20 to 60 kWh (of which 50 % can be made available to the Energy Community).

The broader discussion in the media is very focused on grid reinforcement. At least electric vehicles can exploit locally integrated solutions for electricity generation and consumption, and in this area the capacity issue could be reduced.

- Electric means of transport
- Electric cars
- Batteries
- Local governance
- V2G

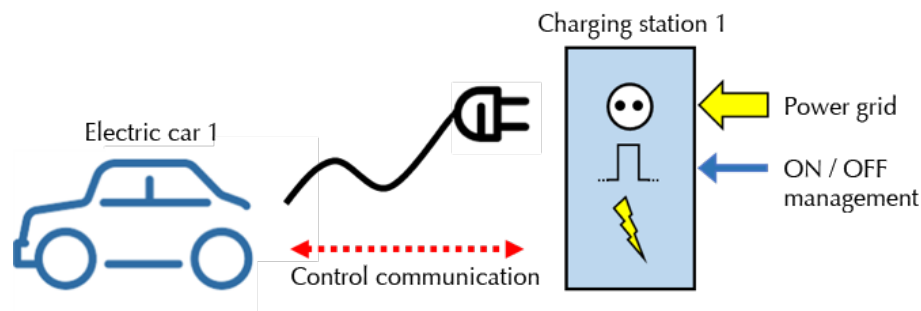

Figure 40 - Outline of a charging station for electric cars with ON/OFF-control

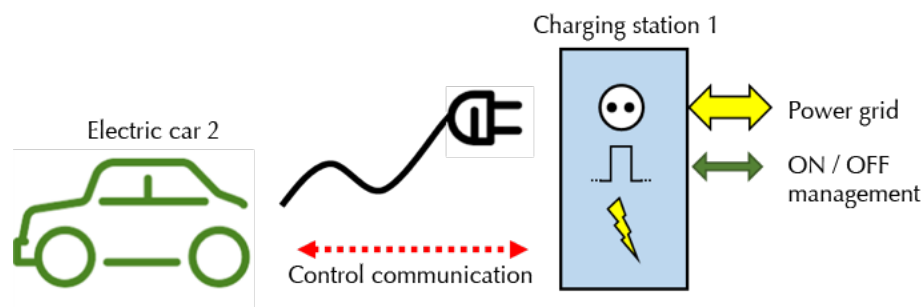

Figure 41 - Outline of a charging station for electric cars with smart control (V2G – vehicle-to-grid technology), the car can charge as well as deliver electricity back to the grid.

### Technical description

Local electric car charging is usually carried out in private areas, while in public recharging points there is usually no single site management system.

- Figure 40 shows an opportunity to guide electric car batteries locally with a recharging point. Allow the pump to be equipped with an ON/OFF governance system to check when the electric vehicle can be charged. Communication between the charger and the electric car is to be carried out on both roads. On the contrary, the charger may only charge the electric vehicle while the electric vehicle cannot supply power to power grids. The consumer may choose a charging meeting that can optimize power consumption, for example at night when the price of electricity is lower. If you choose to charge the electric car during a peak load period, you will pay higher fees.

#### FOR PRIVATE INSTALLATIONS

- Normal recharging point: A recharging point capable of carrying forward a power of not more than 22 kW, excluding devices with an output of less than or equal to 3.7 kW, which are installed in private homes or whose primary purpose is not to charge electric vehicles and which are not accessible to the public. A normal recharging point shall at least be equipped with socket outlets or Type-2 connectors for vehicles as described in standard EN 62196-2: 2017 [2] [3].
- Primary power recharging point: A recharging point that allows for the transmission of power exceeding 22 kW, excluding devices installed in private homes or whose primary purpose is

#### FOR PUBLIC INSTALLATION

- Charging points for motor vehicles: normal AC power recharging points for electric vehicles must for interoperability purposes at least be fitted with socket outlets or vehicle connectors

- As shown in Figure 41, recharging points can be carried out with a smart management system. The charger and the car will communicate both ways to manage the charging process, but in this case the electric vehicle can provide power to the electricity grid. Technocratic logic is called V2G (vehicle-to-grid). The batteries of electric vehicles can be used to provide power, for example during peak load periods, and they can be charged when the electricity demand and the electricity price are low. The system requires specific installations, both in recharging and electric cars (today, only Nissan Leaf ready for V2G control [1]).

The installation of a charging system shall comply with the requirements defined by [3] [4].

not to recharge electric cars and which is not accessible to the public. The minimum power converter recharging points shall at least be equipped with socket-outlet or Type 2 connector for vehicles as described in standard EN 62196-2: 2017 If direct current is used, high power DC power recharging points shall be equipped with connectors of the combined charging system “Combo 2” as described in standard EN 62196-3 [2] [3] at least be fitted with socket outlets or vehicle connectors of Type 2 as described in standard EN 62196-2: 2017. These socket outlets can be fitted with features such as mechanical closure mechanism, while maintaining the Type 2 compatibility [2] [3].

of Type 2 as described in standard EN 62196-2: 2017. These sockets can be complemented with functions like mechanical closing mechanisms at the same time as Type-2 compatibility is maintained [2] [3].

- High power recharging points for motor vehicles: Power converter recharging points for electric vehicles must for interoperability purposes at least be equipped with Type 2 connectors as described in standard EN 62196-2: 2017. Direct Current (DC) high power recharging points for electric vehicles must for interoperability purposes at least be equipped with the combined charging system “Combo 2” as described in standard EN 62196-3 [2] [3].
- Normal power charging point have the effect of 3.7 kW – 11 kW – 22 kW, even though 22 kW is normally not yet installed in households.
- Batteries for electric car scan be used to optimize power production from a solar PV installation and to store surplus production.

- Different connectors exist between electric cars and charging station as shown in Figure 42. Besides the different connector types also different modes of charging must be considered [7].



Figure 42 - Different technical forms of electric car charging contacts. Source: <https://fdel.dk/guides/charge>

## Properties

Figure 43 shows a simple representation of the development of power consumption when many electric cars are connected to the electricity grid. If many electric vehicles are charged at the same time, the power demand may increase and it may cause problems with the supply of electricity. Smart control of electric cars can decide when they are charged, and the batteries can also be used to feed power back to the grid and reduce peak loads.

It may be of interest to the electricity grid company to have the possibility to draw on the capacity of the battery to balance the load of the battery and it has a value that can be translated into money.

Figure 44 shows an example of the charging profile by inflexible charging, where the charging profile of electric vehicles is independent of time-differential neither price signals from both the electricity market and the electricity grid or

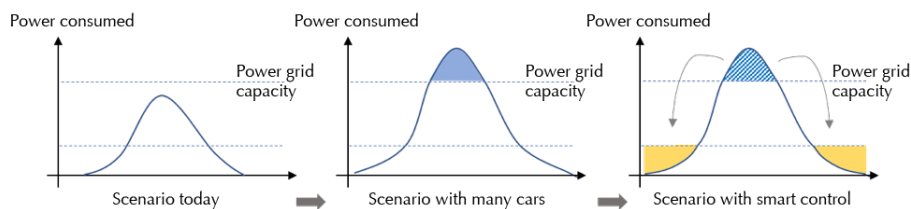

Figure 43 - Expected power consumption with many electric cars connected to the electricity grid

in other way are influenced by capacity restrictions of the electricity grid, e.g. limiting charging power in peak load situations [9].

In the case of inflexible charging, it is possible that all electric cars can recharge at the same time and at times of the day when the need for the perfect is most needed. In order to avoid break downs it is therefore necessary to scale the electricity grid with a certain margin of security, which should take into account a number of extreme cases [9].

Figure 45 shows an example of the charging profile in the case of flexible charging, where the charging of electric cars takes into account both the electricity grid and the electricity price. Charging of electric vehicles is flexible and can

be moved for other periods of the day. For the flexible charging, the following advances have been used:

- The car owners are willing to switch the charging of the electric vehicle to times when the general electricity consumption is low or to limit the rate of charge during periods of time during which the capacity of the network is challenged.
- Charging shall be managed in such a way that the increase in peak power from each household is limited.
- The peak effect of each household rises twice as fast as the energy demand (equivalent to around 15 % of electric cars being heated during the boiling peak) [9].

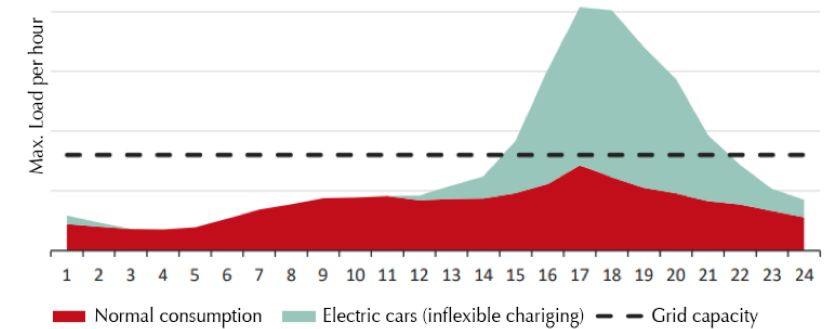

Figure 44 - Charging with inflexible charging (in single family housing area) [9]

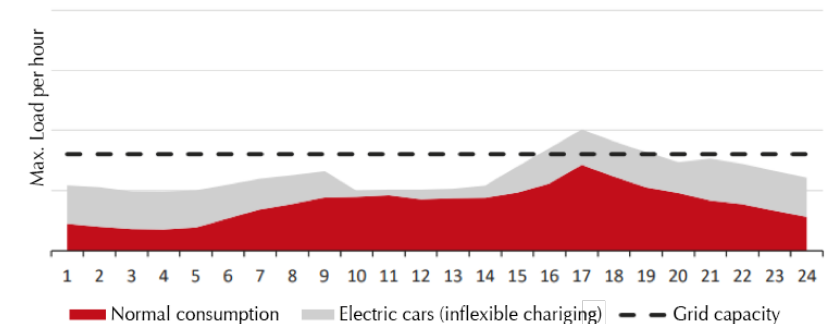

Figure 45 - Charging with flexible charging (in a single family housing area with 48 villas without electric heating, 3.7 kW charging effect per car) [9]

In the flexible scenario, it is assumed that the peak in urban areas is primarily a matter of fast and quick charging. It is assumed that the charging is inflexible as the charging requirements are not acute. The charging profile of fast charging stations is assumed to follow the use patterns seen for standard urban petrol stations. The general pattern of consumption of service stations shows that they are mainly used in the day and evenings, often with peak periods when many are on their way to work or returning home. Figure 46 shows the average

consumption pattern for 10 randomly selected petrol stations in urban areas [9].

The consumption profile of an energy community can be moved by means of a smart control, so that it is done at times when there is not a high load on the grid. In addition, an energy community can choose both to control the charging of electric vehicles in relation to local energy production and, where appropriate, to use electricity from the vehicle's batteries in periods to compensate for high electricity prices.

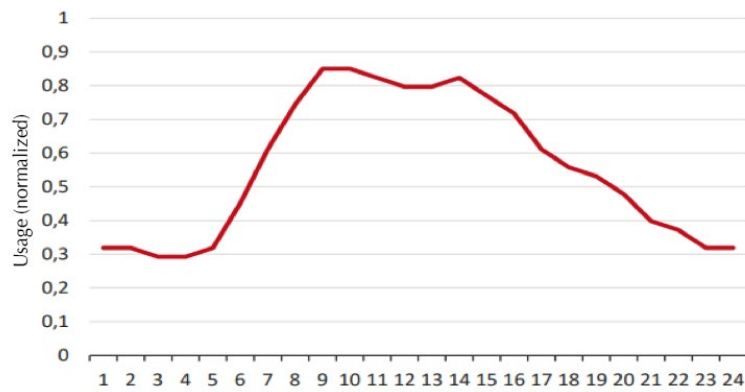

Figure 46 - Use pattern in city areas [9]

ADVANTAGES	DISADVANTAGES
+ Balancing the power grid	- Without management electric cars increase the consumption of power
+ Reduces peak load needs	- Eventual need for grid-strengthening
+ Moving consumption and reach improved energy efficiency of the power grid	
+ Better utilisation of the solar PV facilities production	
+ From fossil fuel to CO2 -neutral driving	
+ Reduce pollution from transportation	
+ Optimize/balance power production from renewable sources	

### ECONOMY

Typical yield	Equipment costs (excl. VAT)	Installation costs (excl. VAT)	Cost of operation and service (excl. VAT)
3,7 - 22 kW	From approx. 3.500 DKK (charging station) + approx. 1.500 DKK (type 2 cables)	Installation costs are dependent of the existing cabling	Approx. 600 DKK/month based on subscription

Danish prices in 2020

### INSTALLATION REQUIREMENTS

- A recharging point must be installed;
- The security system
- Any upgrading of the electricity system.
- Cabling of new connections to the charging point

### Examples

#### SUPPLIERS

- Nuvve
- E-on
- Clever
- Tesla
- Ionity

#### INSTALLATIONS

- Parker project [5]
- Frederiksberg Forsyning [6]

## References

- [1] CleanTechnica 2018. Where are the Vehicle-to-Grid cars? Available online: <https://cleantechnica.com/2018/03/23/vehicle-grid-cars/>
- [2] Sikkerhedsstyrelsen. Opladning af el-biler. Available online: <https://www.sik.dk/erhverv/elinstallationer-og-elanlaeg/vejledninger/elinstallationer/offentlige-omrader/opladning-el-biler>
- [3] Sikkerhedsstyrelsen. 2017. Bekendtgørelse om krav til tekniske specifikationer m.v. for offentligt tilgængelig infrastruktur for alternative drivmidler og motorkøretøjsmanualer. Available online: <https://www.retsinformation.dk/Forms/R0710.aspx?id=198289>
- [4] Sikkerhedsstyrelsen. 2015. Bekendtgørelse om sikkerhed for udførelse og drift af elektriske installationer. Available online: <https://www.retsinformation.dk/Forms/R0710.aspx?id=183511>
- [5] Park project homepage. Available online: <http://parker-project.com/#about>
- [6] Frederiksberg Forsynings hjemmeside. Available online: <https://www.frb-forsyning.dk/om-os/miljoe-i-tal/elbiler-leverer-stroem>
- [7] FDEL - Elbilforeningen. 2015. Hvad sker der i en biloplader? Available online: <https://fdel.dk/guides/cargo/guide-to-charge/>
- [8] FDEL - Elbilforeningen. 2018. Hvordan oplader man en elbil – og hvad koster det? Available online: <https://fdel.dk/hvordan-oplader-man-en-elbil-og-hvad-koster-det/>
- [9] Dansk Energi. 2019. Er elnettet klar til elbilerne? Analyse af effekt- og investeringsbehov i eldistributionsnettet. Available online: [https://www.danskeenergi.dk/sites/danskeenergi.dk/files/media/dokumenter/2019-05/Er\\_elnettet\\_klar\\_til\\_elbilerne\\_Analyse\\_af\\_effekt-og\\_investeringsbehov\\_i\\_eldistributionsnettet.pdf](https://www.danskeenergi.dk/sites/danskeenergi.dk/files/media/dokumenter/2019-05/Er_elnettet_klar_til_elbilerne_Analyse_af_effekt-og_investeringsbehov_i_eldistributionsnettet.pdf)

## 7 COMBINED SHOP COOLING AND HEAT RECOVERY

A cooling machine in combination with a heat recovery unit can be used by shop for cooling. The heat surplus in the process can be used for hot water production, as well as for space heating in a building, or it can be turned to a multiple network. Typically, size is 15-70 kW but the plant can be larger in larger stores.

- Heat recovery
- Shop cooling
- Heat pump
- District heating grid
- Surplus heat

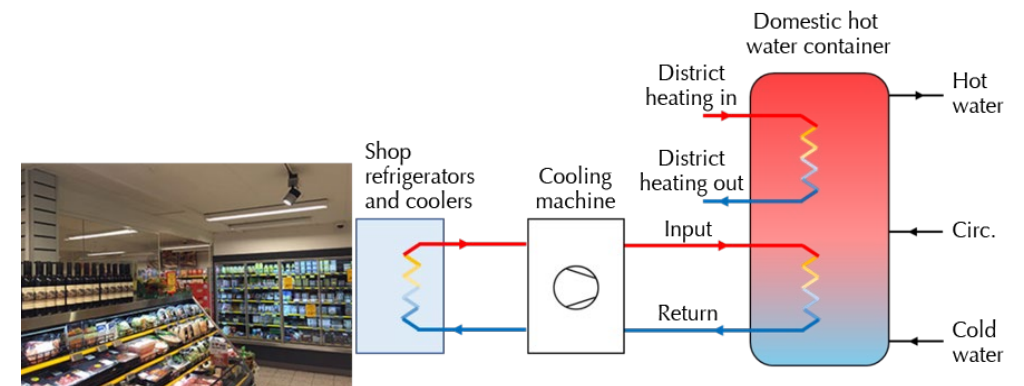

Figure 47 - Outline of a heat recovery installation with a cooling machine and a hot water container

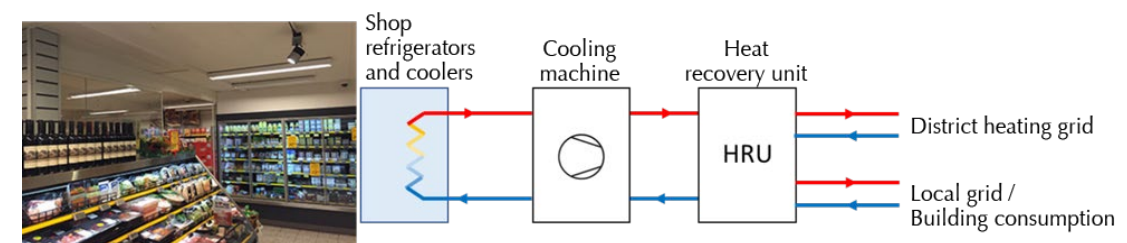

Figure 48 - Outline of a heat recovery installation with a cooling machine and a heat recovery unit





Figure 49 - Example of CO<sub>2</sub> cooling installation. Indoor unit (left) and outdoor unit (air cooled condenser) (right). Source: JF køleteknik A/S



Figure 50 - Danfoss heat recovery unit (HRU) for heat recovery from a cooling system (Source: [https://www.energy-supply.dk/announcement/view/103768/overskudsvarme\\_fra\\_koleanlaeg\\_bruges\\_som\\_fjernvarme](https://www.energy-supply.dk/announcement/view/103768/overskudsvarme_fra_koleanlaeg_bruges_som_fjernvarme))

## Technical description

- A cooling system works with the same principle as a heat pump, as it can pump heat from a cold reservoir to a heat reservoir.
- Cooling equipment can be used as decentralized heat sources by a district heating grid.
- The heat from a shop cooling installation is available for the whole year, but it is not controlled by the heat demand of the buildings or of the district heating system. For this reason, the system requires the integration of a heat storage device. It can be carried out as a hot water storage tank (Figure 47) or a heat recovery unit (Figure 48) [1].
- The heat recovery unit shown in Figure 50 must be used in combination with a cooling machine. The new EU regulation on F-gases in refrigeration systems sets limits on which coolants are to be used in relation to their 'Global Warming Potential (GWP)' effect. CO<sub>2</sub> has therefore become a common refrigerant in the refrigeration system, since GWP is lower than other refrigerants.
- All heat pumps with more than 1 kg of refrigerants must be inspected at least once a year. The inspection and maintenance, etc. of the refrigeration equipment and heat pumps shall be carried out by a person who has been given the necessary instructions, inspection and service training. In the case of plants with more than 2.5 kg of refrigerant, the annual inspection shall be carried out by a certified technician from a registered refrigeration firm [3].

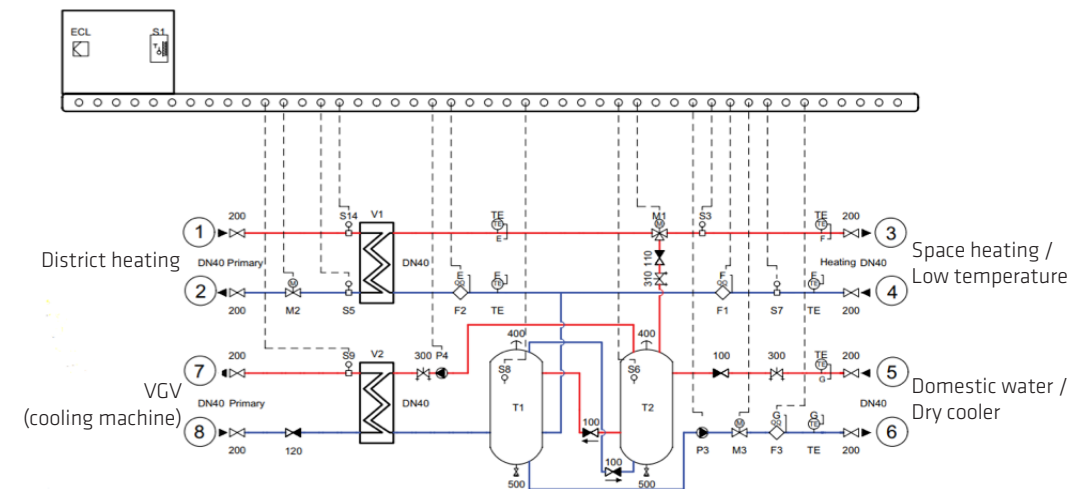

Figure 51 - Principle of a Danfoss heat recovery unit (HRU) with indirect connection to the district heating [2]

## Properties

- the heat storage unit allows heating to be used with a time lag in relation to the start/stop of the refrigeration equipment.
- By shunting using district heating independence of the condenser temperature of the refrigeration equipment.

ADVANTAGES	DISADVANTAGES
+ Utilises the excess heat/renewable energy	- Noise problems related to the outside part (can be reduced using heat recovery unit)
+ Heat recovery from cooling installation	
+ Excess heat can be used to complement the need for heating in a building	
+ The installation can operate as a decentral heat source for the district heating grid	
+ Heat recovery from shop cooling installation can reduce the need for heating and reduce the the environmental load	

## INSTALLATION REQUIREMENTS

### Refrigerator (indoor)

- Connection to electricity grid
- Connection to the heat recovery unit
- Connection to the freezer or refrigerator
- Connection with the outdoor part

### Refrigeration machine (outdoor)

- Connection to the indoor part

### Heat recovery unit

- Heat pump connection
- If necessary, connection to the district heating grid

## ECONOMY

Typical yield	Equipment costs (excl. VAT)	Installation costs (excl. VAT)	Cost of operation and service (excl. VAT)
Heat recovery unit 22-540 kW	49.000-108.000 DKK*	Approx. 50-100%* (relation to unit price)	Approx. 1-2%* (relation to unit price)

Danish prices in 2020

## Examples

### SUPPLIERS

- Danfoss
- Alfa Laval/Cetetherm

### PLANT

- ABC Lavpris' shop in Randers

## References

[1] Lund, H et al. 4th Generation District Heating (4GDH). Integrating smart thermal grids into future sustainable energy systems. Energy. <http://dx.doi.org/10.1016/j.energy.2014.02.089>. <http://dx.doi.org/10.1016/j.energy.2014.02.089> Available online: [https://www.sdu.dk/-/media/files/om\\_sdu/institutter/iti/forskning/nato+arw/literature/4th+generation+district+heating+4gdh.pdf](https://www.sdu.dk/-/media/files/om_sdu/institutter/iti/forskning/nato+arw/literature/4th+generation+district+heating+4gdh.pdf)

[2] Danfoss datablad. HRU – Varmegenvindingsunit. [http://hiti.danfoss.com/PCMPDF/VDMGD101\\_HRU-heat-recovery-unit\\_1711.pdf](http://hiti.danfoss.com/PCMPDF/VDMGD101_HRU-heat-recovery-unit_1711.pdf)

[3] Beskæftigelsesministeriet 2007. Bekendtgørelse om anvendelse af trykbærende udstyr. Available online: <https://www.retsinformation.dk/Forms/>

## 8 ADDITIONAL ELECTRICITY HEATING OF DOMESTIC HOT WATER

Additional electric heating of hot water can be installed as a combination of district heating and another heat source using electricity to produce heat. The system may be equipped with an electrical boiler or a heat pump and, if necessary, a photovoltaic installation may be installed in order to reduce operating costs. Typically, power heat/heat pump 10-50 kW per apartment block and photovoltaic installations, if any, are typically 100-300 m<sup>2</sup> per apartment block.

- Electric heating
- Domestic hot water;
- Electric boiler
- Heat pump
- Solar PV

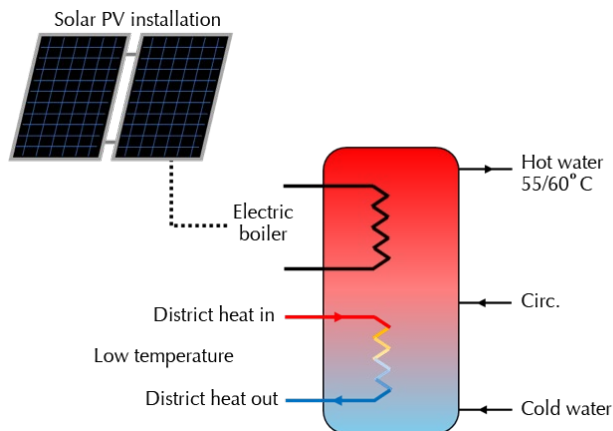

Figure 52 - Outline of an electric heating system (electric boiler) for domestic hot water in interaction with district heating. The picture on the right shows a 54 kW electrical heating system using 9x6 kW power units in a 2500 liter hot water storage tank

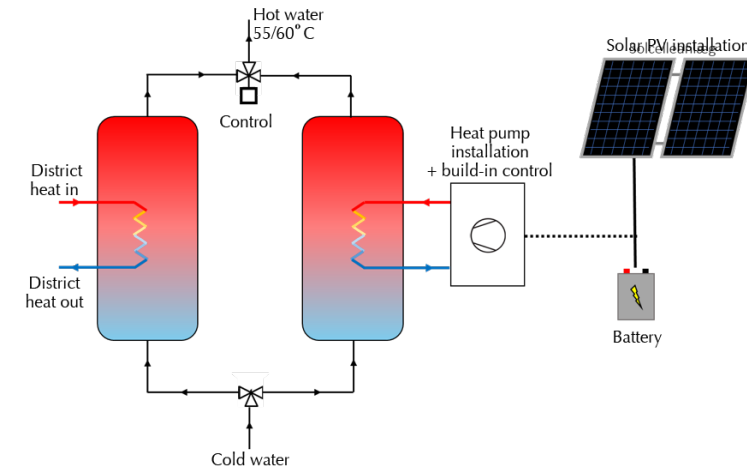

Figure 53 - Outline of an electric heating pump (heat pump + el-cartridge) for domestic hot water in interaction with district heating and, where appropriate, photovoltaic installations.

### Technical description

- As shown in Figure 52, additional electrical heating of hot water is provided in a tank where an electrical boiler is installed to increase the temperature of water in interaction with the primary heat source (e.g. district heating). The hot water container is used for peak loads. Hot water may be stored when the consumption is low and it can be supplied during high peak periods.
- The hot water storage tank reduces the needed capacity of district heating pipes, but increased heat loss has to be considered within the buildings.
- In a low temperature network, the district heating can be used to heat hot water, while the power boiler acts as a 'supplementary after-heater' to satisfy the temperature requirement.
- In a general network, the power cartridge can be used to provide (additional) heat when the electricity price is low, e.g. when solar PV power is in surplus.
- Usually electricity boilers have a high effect, therefore the power supply company may require an upgrade (main fuse).
- As shown in Figure 53, electric heaters can be combined with a photovoltaic installation. The installation can reduce operating costs, as it produces cheaper electricity for electric heating. It is expected that a battery pack is also installed to save the current surplus. In this way the electricity heating system can use the flow of the photovoltaic installation during periods when the installation is not produced (e.g. at night).
- A heat pump system can also be equipped with a photovoltaic installation to generate cheap power.
- Hot water storage tanks are usually built in enameled steel and protected by an anode, as it is cheaper than using stainless steel. Hot water tanks are often carried out as modules of 800-1000 liter for multi storage housing blocks.

## Properties

- Additional electricity heating for hot use water is an interesting solution in an energy that generates electricity from renewable energy sources (e.g. wind turbines). When the electricity price is low, they can produce hot water and save energy in hot water storage tanks and implement a displacement of consumption.
- A heat pump can also be used as an alternative heat source. As shown in Figure 53, domestic hot water is produced in two different containers. The first is connected to

the district heating grid, while the other is connected to the heat pump. When it is cheaper to use power from the grid, the heat pump can be used to produce hot water and save energy in the container. On the other hand, district heating can be used when it is cheaper than using electric power. The heat pump is also equipped with an electric boiler which can be used in periods when the heat demand cannot be satisfied by the heat pump.

ADVANTAGES	DISADVANTAGES
+ An installation with only one electric boiler has low investment and installation costs	- High energy price without solar PV panels
+ An installation with electric boiler can secure a guarantee a higher flexibility than a heat pump installation, as it is not dependent of a heat source	- Risk of blackout or other problems related to the power supply due to peak load needs
+ Can increase the energy flexibility of the energy system	- The power system may need an upgrade
+ A heat pump installation can reduce operational costs, in case of high COP	
+ Næsten alle materialer kan genbruges	

## INSTALLATION REQUIREMENTS

An electric heating system normally comprises of a hot water tank placed in a technics room. The tank is connected to heat sources and domestic hot water supplies.

- Space to install the hot water tank
- In multistore buildings more tanks might be needed
- Connection to the electricity system when an electric boiler is installed, which might need high effect from the power system and a protection system
- Connection to the photovoltaic installations;
- Connection to district heating grid or a heat pump facility including a pressure control system
- Connection to the cold-water supply;

## ECONOMY

Typical yield	Equipment costs (excl. VAT)	Installation costs (excl. VAT)	Cost of operation and service (excl. VAT)
160 kW* (Expecte additional power based heating of approx. 30%)	Approx. 45.000 DKK*	Approx. 11.000 DKK*	Fixed: 80 DKK/kW/år* Variable: 7 DKK/MWh*

### Danish prices in 2020

*In the Technology Catalogue for individual heating systems the following directional data are provided. The figures refer to a property with about 110 smaller apartments. The price level per installed kW can also be used for a larger installation serving buildings 450 flats.*

*\* data for a new building [2]: Area: 8.000 m. 2, heat consumption: 320 MWh/year; peak load (heat): 160 kW, 100 % of hot water demand, 100 % of space heating needs*

## Examples

### SUPPLIERS

- Racell – Sapphire Group
- Värmebaronen AB
- Metro Therm

### INSTALLATIONS

- Trigeiparken i Aarhus [3]

## References

[1] Energistyrelsen 2018. Technology Data for Energy storage. Available online: [https://ens.dk/sites/ens.dk/files/Analyser/technology\\_data\\_catalogue\\_for\\_energy\\_storage.pdf](https://ens.dk/sites/ens.dk/files/Analyser/technology_data_catalogue_for_energy_storage.pdf)

[2] Energistyrelsen and Energinet 2017. Teknologikatalog for produktion af el og fjernvarme. Available online: <https://ens.dk/service/fremskrivninger-analyser-odeller/teknologikataloger/teknologikatalog-individuelle>

[3] Ready project website. Available online: <http://www.smartcity-ready.eu/>

## 9 SOLAR HEAT ADDED TO THE HEATING SYSTEM

An energy community can produce part of its heat demand, for example, using solar heating plants which use solar power to produce heat for space heating and domestic hot water. The installation can be integrated in the building or district level together with an additional heat source (e.g. district heating) to ensure that the heat demand is always covered. Typical instal-

lation size is 40-200 m<sup>2</sup> thermal solar panels placed on the roof of the apartment blocks, preferably on roof surfaces turning south.

- Solar thermal
- District heating
- Space heating
- Domestic hot water

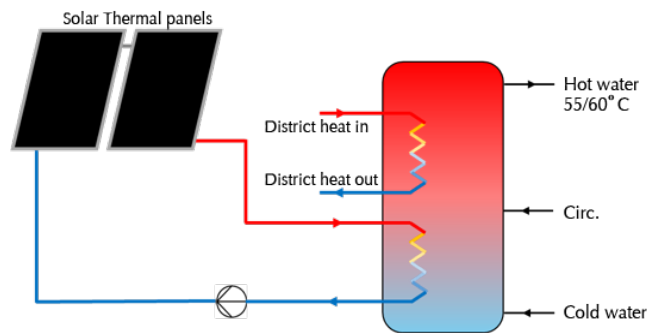

Figure 54 - Outline of a solar thermal installation in combination with district heating to deliver domestic hot water. The hot water is heated by two sources.

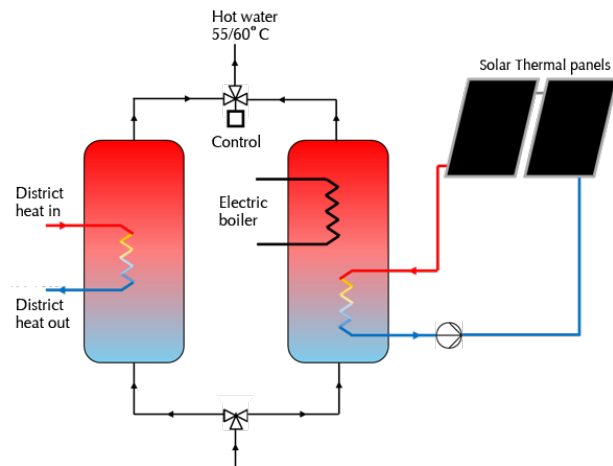

Figure 55 - Outline of a solar thermal installation in combination with district heating. The solar collector heats water in the container equipped also with an electric boiler.

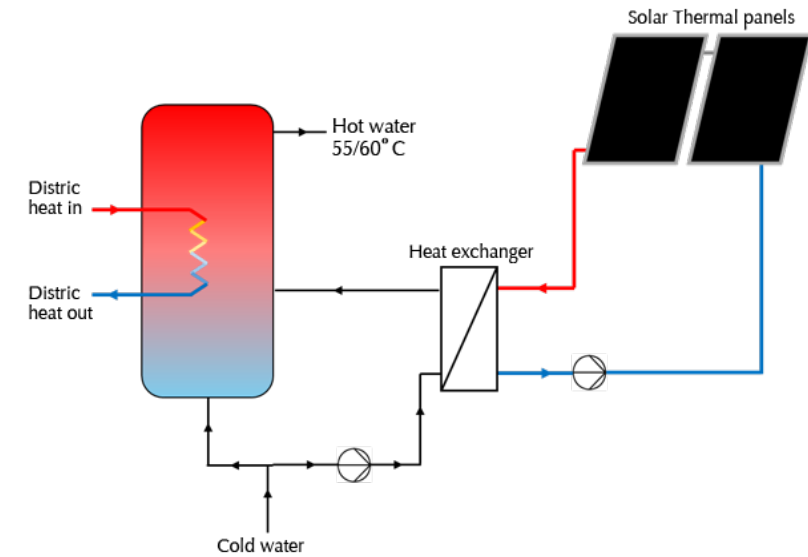

Figure 56 - Principle of a solar thermal installation in combination with district heating. Hot water is pre-heated by solar panels through a heat exchanger

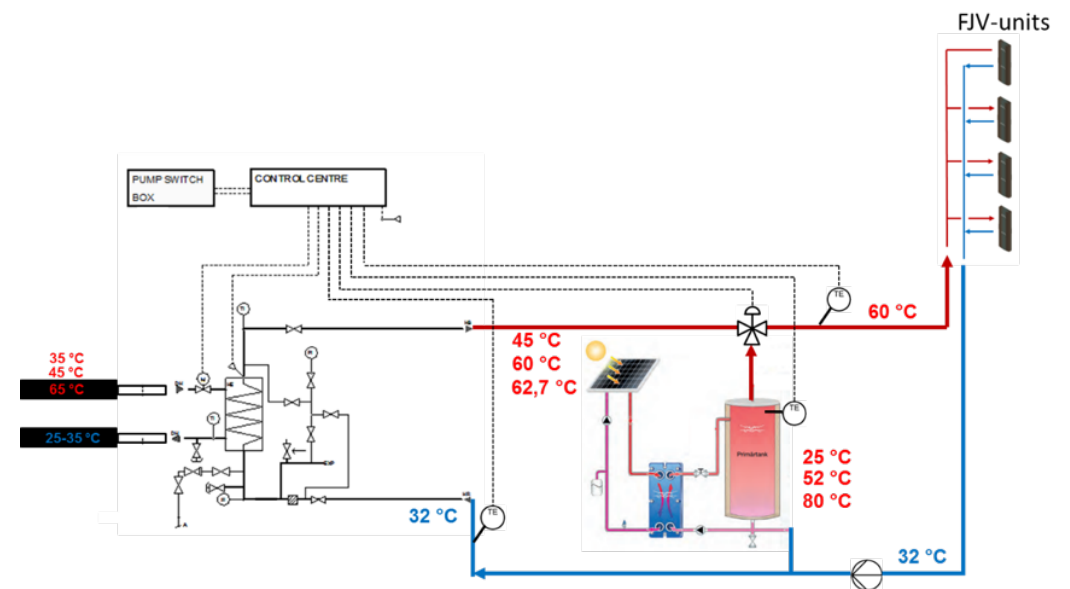

Figure 57 - Principle of a solar thermal installation in combination with district heating and installation of district heating units (Source: Alfa Laval)



## Technical description

### SOLAR THERMAL FACILITY

- A solar thermal facility is usually installed to contribute to domestic hot water production. But some installations can also be considered for space heating.
  - The solar panels are operating the best when turned to the south, south-west or south-east, with a slope of approx. 45 degrees. On flat roofs, a support structure must be built to provide solar panels with the required gradient. Solar panels must be placed avoiding shadows.
  - If the roof is not suitable for the panels, a renovation of the roof is needed. In addition, consideration should be given to the fact that the panels can result in collection of snow during snowfall in the winter.
  - The roof area must be large enough. A small installation may not be able to pay off.
  - The municipality can set rules for solar panels, for example in relation to their reflectance. Before installing solar panels, it is necessary to contact the municipality and to check whether there are special requirements in local plans, heritage protection and servitudes (solar panels is available with anti-reflex treated glass).
  - The building regulation puts demands on the distance from neighbors (in particular for single family houses).
  - A high service pressure reduces the risk of boiling of the pipe water.
  - The installation as shown in Figure 57 requires the installation of district heating units in each apartment and a main heat exchanger. Solar heaters can contribute to both space heating and domestic hot water production.
  - Solar panels can also provide heat directly to a district heating grid, but it can best pay off if the district heating company owns the solar thermal panels.
  - In relation to the size of the solar panel, an apartment block requires around 0.5-1 m<sup>2</sup> (solar panels) per occupant. The price per m<sup>2</sup> of the solar plant is lower in larger plants (> 40 m<sup>2</sup>).
- The buildings installation size:**
- Buffer tanks/hot water tanks are often produced built as modules of 800-1000 liter. This guarantees energy flexibility and peak smoothening.

## Properties

- Expected payback time in Denmark, 10-13 years.
- The performance of solar panels depends on the weather, time of the year and orientation of the solar collector.

### INSTALLATION REQUIREMENTS

#### Solar thermal panel

- Connection to the heat container
- Circulation pump for solar thermal panel (frost-free fluid)
- Solar panels should be securely attached to the integral design in a way that does not cause leakage in a roof or wall design

#### Container

- Connection to multiple heat
- Access to sanitary water
- Connection to solar collector

ADVANTAGES	DISADVANTAGES
+ Renewable energy	- Only focus on providing domestic hot water
+ Solar thermal panels can be integrated into the city environment and can be used as part of the buildings climate shield	- Most efficient in the summer period
+ In the summer can solar thermal provide the complete energy needs	
+ A large installation has lower costs than a smaller one (per square meter)	
+ Reduces operational costs	

## ECONOMY

Typical yield	Equipment costs (excl. VAT)	Installation costs (excl. VAT)	Cost of operation and service (excl. VAT)
140 kW*	392.000 DKK*	211.000 DKK*	Fixed: 2.900 DKK/år* Variable: - DKK/MWh*
140 kW**	358.000 DKK**	193.000 DKK**	Fixed: 2.900 DKK/år** Variable: - DKK/MWh**

## Danish prices in 2020

In the Technology Catalogue for individual heating systems the following directional data are provided. The figures refer to a property with about 110 smaller apartments. The price level per installed kW can also be used for larger installations serving built areas of 450 flats.

\* data for an existing building [2]: Area: 8.000 m<sup>2</sup> (approx. 110 smaller flats). Heat consumption: 960 MWh/year, peak load (heat): 400 kW, Solar thermal panel area: 200 m<sup>2</sup>, typical solar panel output: 425 kWh/m<sup>2</sup>, 65 % of hot water demand

\*\* data for a new building [2]: Area: 8.000 m<sup>2</sup> (approx. 110 smaller apartments), heat consumption: 320 MWh/year; peak load (heat): 160 kW, solar thermal panel area: 200 m<sup>2</sup>, typical solar panel output: 450 kWh/m<sup>2</sup>, 65 % of hot water needs

## ENVIRONMENTAL ASPECTS

- Almost all materials can be re-used
- The liquid used in the plant is normally to be treated as low toxic chemical waste;
- Requirements for the temperature in the domestic hot water container 55° C (occasionally up to 60-65 °C concerning Legionella)

## Examples

## SUPPLIERS

- Batec-solvarme
- Arcon-Sunmark A/S

## EXISTING INSTALATIONS

- Building blocks in the social housing sector

## References

[1] Energistyrelsen. Solvarme. Tilgængeligt online: <https://spareenergi.dk/forbruger/varme/solvarme#Husets%20egnethed>

[2] Energistyrelsen and Energinet. 2016. Teknologikatalog for individuelle opvarmningsanlæg. Tilgængeligt online: <https://ens.dk/service/fremskrivninger-analyser-modeller/teknologikataloger/teknologikatalog-individuelle>

## Proposals for standard statutes

A standard statute for an energy community must include provisions on the participating partners and their shared responsibility and duties of the Community. On the basis of the conclusions of the section on the 'Energy communities in company law' (p. 31), two types of companies that are particularly relevant for energy communities

- Cooperative
- Association

In the first – the Cooperative – there are a number of provisions which provide the involved partners with equal rights. Consequently, there will be a need to regulate, for example, cost-allocation as well as regulations of influence and decision making etc. The second – the Association – provides more flexibility for how to regulate with influence, decisions, etc.

A statute must contain provisions on decision-making powers, directors' liability and rules for entering and leaving the community, as well as ownership of joint facilities.

In addition, provisions must be made to ensure the recognition of the energy community in negotiations with authorities and common suppliers on permits for installations and on agreements concerning the use of common transmission grids and on tariffs for the use of these.

The two examples of statutes drawn up on the following pages are not comprehensive in their detail, but indicate the structure of the statutes and the parts and articles. Their content will have to be detailed in accordance with the specific energy community to which they must apply.

## CONTENTS

Statute for an association.....	120
Statute for a cooperative.....	128

## **STANDARD STATUTES FOR AN ENERGY COMMUNITY ORGANISED AS AN ECONOMIC ASSOCIATION (WITH LIMITED LIABILITY) INCLUDING A GENERAL ASSEMBLY**

### **§ 1. NAME AND REGISTERED OFFICE OF THE Association**

1.1 The Association name is a xx [1] limited responsibility that is reduced as follows: xx (limited liability)

1.2 The registered office of the Association is established in the municipality of xx.

*[1] (name as decided at the general assembly)*

### **§ 2. PURPOSE**

2.1 The general objective of the Association is to provide the members with the best possible [2]

2.2 As part of these objectives, the Association may contribute to marketing, product development and market development of xx [3]

2.3 The Association shall be independent of other organizations, companies and public institutions and shall not be subject to instructions from such if they are members of the Association. Instructions can be given only to the member of the Association, who represents the organization, the company and/or the public institution.

*[2] e.g. production, including based on renewable energy sources, distribution, supply, consumption, aggregation, energy storage, energy efficiency services or electric vehicle charging services, or other energy services – examples: (1) settle the production of electricity produced from the photovoltaic installation at (address) or wind turbines at (address), (2) the purchase of renewable energy from within the local area (organization, address), (3) promoting the development and the extent of local RES production and the storage of RE – restricted as an activity from within the local area.*

### **§ 3. MEMBERSHIP**

#### **ENROLMENT**

3.1 As members may be enrolled persons, Associations, housing societies, organizations, public institutions and companies that are interested in and willing to work for the purpose of the Association. No applicants representing professional actors with extensive commercial activities in the energy sector may be admitted, including investments in the energy sector.

3.2 The enrolment shall be made on the Association's notification form. Membership is not valid until the applicant's membership is approved by the Management Board, [4]

*[4] and once the member has paid subscription (if such is collected).*

3.3 The Management Board of the Association decides without appeal on whether an applicant satisfies the conditions for enrolment.

3.4 Where a member sells, transfers or surrenders his asset that forms part of the Association's activities, [5] to another, the new owner or user, with the consent of the Management Board, may be subrogated to rights and obligations towards the Association. When the transfer is properly documented and consent is taken by the Management Board, the seller/transferor or lessor shall be exempted from her obligations.

3.5 If an asset is operated jointly by 2 or more legal persons, either directly or in the form of a company, membership can only be achieved jointly and severally (as one member). Owners or users shall then appoint an authorized to exercise the voice and voting rights in the Association.

*[5] (e.g. PV or battery)*

#### **RESIGNATION AND EXCLUSION**

3.6 Membership may cease at the end of an accounting year in such a way that a member notifies, in writing and at least 6 months' notice, that it would withdraw from the Association.

3.7 The Management Board may, on appeal to the general assembly with 2/3 majority, decide to exclude a member who does not fulfil the obligations imposed by the membership obligations or who is acting to the detriment of the Association.

3.8 Members who no longer fulfil the conditions for membership can be excluded by the Management Board's decision.

3.9 If an excluded member wishes to bring the exclusion to the next general assembly this must be done by written notice to the Management Board submitted within a period of 1 months after the exclusion is notified in writing to the member concerned. In the period of the member's exclusion and until the general assembly, a member may not make use of the membership.

3.10 In the event of resignation or exclusion, the member shall have no claims in the assets of the Association.

3.11 The member is obliged to comply with the statutes of the Association and comply with its purpose.

## § 4. REVENUE

(AND TURNOVER – see § 4, 3)

4.1 The income of the Association consists of [6]

4.2 The Management Board may propose to an ordinary as well as to an extraordinary general assembly that a temporary increase in (subscription/quota) based on extraordinary activities.

4.3 – to be inserted if the distribution is requested.[7]

## § 5. MANAGEMENT BOARD

### TASK AND ELECTION

5.1 The day-to-day management of the Association is maintained by the Management Board consisting of x persons. The Management Board is responsible for the activities of the Association in relation to the existing legislation, the present statutes and the decisions made by the general assembly.

5.2 Members of the Management Board are elected for 2 years at any one time, x in one year and x in the following year. As far as possible, it must be ensured that the different categories of members are represented on the Management Board.

5.3 X alternate members shall be elected to enter the board in the event of continued absence until the next general assembly.

5.4 Only members may be elected to the Management Board.

5.5 At the first meeting following the general assembly, the Management Board shall constitute the board with a chair, a vice-chair, a treasurer and a secretary. The vice-chair shall act as chair in case of the absence of the chair.

## § 6. TASKS OF THE BOARD

6.1 The board shall adopt its rules of procedure.

6.2 Board meetings shall be held when the chair considers it necessary or when x members of the board require.

6.3 The invitation shall include an agenda in writing.

6.4 The minutes of the board meeting is a summary of the decisions and must be signed by the members of the Management Board.

*[6] Examples: (1) members shall pay a subscription fee fixed by the general assembly. The quota is collected before each financial year; (2) members pay a rate per kWh generated/purchased/stored. The annual rate of the ordinary general assembly; (3) return on cash and cash equivalents; (4) an Association contribution may also be agreed upon, which must be decided upon in a provision of the Associations' regulations.*

*[7] In the event of a distribution of any profits made by the Association, while it is in operation, it must do so (1) with equal shares in each of the participants, (2) in proportion to the turnover achieved by each of them with the fund. (The latter may be used, for example, in the production of electricity)*

6.5 The Management Board takes a decision by simple ballot, but shall have a quorum only when more than half of the members of the Management Board are present. In the event of a tie, the chair or the acting chair shall have the casting vote. Vote may (not) be given by power of attorney.

6.6 The Management Board may, from among its members, set up a business committee to act on behalf of the Management Board in minor cases that cannot be postponed. It may also set up committees and working groups for defined tasks.

6.7 The business committees' arrangements must be presented at the next meeting of the Management Board for approval.

6.8 The Management Board may, where necessary, employ paid labor.

6.9 The Management Board appoints/proposes candidates for representation of the Association's interests in companies and Associations.

## § 7. GENERAL ASSEMBLY

7.1 The ultimate authority of the Association is the general assembly.

### CONVOCATION

7.2 Ordinary general assemblies shall be held once a year in xx month.[8]

7.3 Extraordinary general meetings may be summoned by the Management Board of its own motion or at the request of at least 1/5 of its members who shall submit a written claim stating the motivated item for the agenda to be handled.

7.4 In the latter case, the Management Board shall convene the general assembly within a maximum of 1 month and based on at least 14 days' notice within 14 days from the receipt of the written request by the members.

7.5 The call to an ordinary general and an extraordinary assembly shall be distributed with at least 14 days' and a maximum of 1 months' notice.

7.6 The call shall contain the agenda, where the following points are mandatory at ordinary general assemblies:

1. Nomination of the chairman and rapporteur.

2. Report of the Management Board on the previous year, subject to approval by the general assembly.

*[8] (typically not later than 5 months after the end of the financial year)*

3. Presentation of a financial report including the decisions to be made concerning balance/deficit, including a decision on any distribution to members.[9]

4. Setting xx [10] with effect from the start of the next calendar year.

5. The presentation of the budget to be approved by the general assembly.

6. Proposals received.

7. Election of the Management Board and election of alternate members.

8. Election of financial auditor.

9. Any other business

7.7 Proposals for consideration at the general assembly shall be forwarded to the chair of the Management Board before 30 days prior to the assembly. The board shall forward them to the members at least 14 days before the general assembly.

7.8 The members of the Association entitled to attend the general assembly are all members having a valid member certificate documenting their access.

#### VOTING RIGHTS

7.9 Voters are members of the Association only and each member has 1 vote.

#### IMPLEMENTATION

7.10 Decisions at the general assembly are taken by a majority among the votes of the members attending the assembly and entitled to vote, unless otherwise provided by these statutes. Each member may only hold a single proxy.

7.11 Votes shall be held in writing if only one of the members present so wishes.

#### COMMUNICATION

7.12 The Management Board and, if applicable, the employees of the Association are entitled to provide all communications, calls, collection, etc., in accordance with these articles of Association, by digital mail, and documents may be forwarded digitally, provided via the Association's website or by other means of file sharing on the internet.

7.13 The member must, if possible, provide the Management Board and, where applicable, with an e-mail address or corresponding digital contact address. The member shall be responsible for informing the Management Board and

*[9] In the case of a differentiated distribution, for example calculated on the exchange in relation to the Association, a specific provision should be inserted – see suggestion in § 4, 3.*

*[10] examples: subscription/kWh-quota*

any staff member of any changes to this information.

7.14 Notifications and documents sent to the e-mail address or the corresponding digital contact address as communicated by the member, are considered delivered by the Management Board to the member. Documents provided on the Association's website or via other file sharing on the internet are to be considered correctly presented. In the latter case, however, a digital message has to be sent to the members with reference to documents presented at home page/Internet.

7.15 Members without email addresses or without access to the Internet will receive calls and materials per common mail or registered mail.

7.16 The Management Board and eventual staff are, without prejudice to the provisions of 7.12-15, entitled to provide communications, etc. with regular or registered mail.

## § 8. ACCOUNTS AND ASSETS

8.1 The assets of the Association consist of the assets of the Association, deducted any liabilities.

8.2 For the use of existing and future balance resulting from the Association's activity can during xx years in accordance with the purpose of this Association be donated to Associations, stakeholder organizations and corporations to general environmental, social and/or other economic activities within the Association's field or remain in standing in the Association, as long as this exists. Unused funds may be carried over to the following financial year.

8.3 The financial year of the Association shall be the calendar year.

8.4 The Association's accounts shall be audited by a registered or chartered accountant elected by the general assembly if the assembly decides to appoint a financial auditor.

## § 9. POWER TO BIND AND LIABILITY

9.1 The power to bind the Association rests [11]

9.2 The Management Board may grant procuration.

9.3 The Association is liable with all its assets with respect to third parties and to its members.

9.4 There is no joint liability of the members of the Association for the Association's obligations.

*[11] examples: 1) of the entire Management Board, 2) the chair and vice-chair together with another member of the Management Board).*

## § 10. CHANGES TO THE STATUTES AND SUBSTANTIAL TRANSACTIONS

10.1 Amendments to these Statutes, including mergers with other Associations, require the adoption of a general assembly with 2/3 of the votes cast.

10.2 The admission of loans, the purchase, sale and rehypothecation of assets, as well as any other material business and transaction relating to the Association, must be approved by the general assembly by at least 2/3 of the votes cast at a meeting of the assembly.

## § 11. DISSOLUTION

11.1 The dissolution of the Association shall be subject to decision by a general assembly with 2/3 majority among all members. If this majority is not achieved, the Management Board is entitled to convene a new general assembly, at which the dissolution can be adopted by 2/3 majority among the members present.

11.2 At the dissolution of the Association, the assets of the Association shall be distributed by decision of the general assembly which definitively decides upon the dissolution of the Association as follows:

- a) The net assets – after all debts have been paid and other commitments imposed by the Association – are allocated to Associations, stakeholder organizations, corporations or other legal entities for use in accordance with the objectives as stated for this Association.
- b) The net asset is donated to a charitable purpose (environmental, social and/or economic).
- c) The net assets shall be distributed equally among the members registered at the date of the general assembly that finally decides on the dissolution of the Association.

11.3 The general assembly shall be free to decide on a full or partial combination of the conditions of use referred to above under points a, b and c above.

11.4 The general assembly shall elect 2 liquidators in charge of dissolution of the Association.

## § 12. ARBITRATION

12.1 Any matter relating to the understanding of these statutes, including the question whether or not there is a breach of this statute, shall be subject to final arbitration in accordance with the arbitration law at any time.

12.2 The arbitration tribunal shall operate according to the following guidelines:

- a) The party seeking arbitration shall notify the other party in writing, by means of a simple letter, of the intention to arbitration, the question to be referred to the arbitration tribunal, the pleas in law on which it is based and the person whom it has chosen as an arbitrator. Within 14 days of its receipt, the other party shall notify its appointed arbitrator and give their allegations and objections. If the time limit is exceeded the arbitrator is appointed by the at any time being [12]
- b) The arbitrators shall elect an independent arbitrator who shall be a lawyer and president of the arbitral tribunal and lay down the rules for the examination of the case. However, each party must have the opportunity to put forward 2 written positions to the arbitral tribunal.
- c) If the arbitrators cannot agree on the election of a middle man within 14 days, this will be appointed by it at any time being [13]
- d) The order of the arbitral tribunal shall be final and binding on the pairs and the arbitral tribunal shall determine the costs of the proceedings and their distribution between the parties, taking into account the outcome of the proceedings.
- e) The proceedings before the arbitral tribunal and the arbitration shall not be publicly available and the forum referred to in that law shall be the registered office of the company.

These statutes are adopted at the inaugural general assembly of the Association on xx  
[signed by the chair of the meeting]

*[12] President of the Court of Appeal of Eastern/Western Denmark or the District Court of xx*

*[13] President of the Court of Appeal of Eastern/Western Denmark or the District Court of xx*



**STANDARD STATUTES FOR AN ENERGY COMMUNITY  
ORGANISED AS COOPERATIVE (A.M.B.A.)  
INCLUDING A Members Council**

**§ 1. NAME AND REGISTERED OFFICE**

- 1.1 Its name is xx A.M.B, A (“Cooperative”).  
1.2 The Cooperative is a limited liability Cooperative society.  
1.3 The registered office of the Cooperative is established in the municipality of xx.

**§ 2. PURPOSE**

- 2.1 [1]  
2.2 The Cooperative may also pursue the above objective, directly or indirectly, in relation to and with natural or legal persons who are not members of the Cooperative.

**§ 3. MEMBERS**

- 3.1 A member of the Cooperative is any natural or legal person [2]. The composition of members of the Cooperative is defined by principles laid down by the Management Board.  
3.2 In their capacity as legal entities, companies, capital companies, Associations and other similar forms of companies and Associations, as well as housing societies and the autonomous departments of these organizations, each and their own authorities and their own administrative units, shall be regarded as separate legal persons.  
3.3 If a member no longer satisfies the conditions for being a member of the Cooperative, it must be excluded from the date on which the conditions are no longer fulfilled.  
3.4 A member cannot claim any part of the assets of the company, including in case of withdrawal, irrespective of reason. [3]

**§ 4. LIABILITY OF MEMBERS**

- 4.1 Only the Cooperative’s obligations are liable to the Cooperatives’ assets. No member shall be liable for the obligations of the Cooperative.

*[1] (for example, production, including based on renewable energy sources, distribution, supply, consumption, aggregation, energy storage, energy efficiency services or electric vehicle charging services, or provide other energy services – examples: (1) settle produced electricity produced from the photovoltaic installation at (address) or wind turbines at (address), (2) the purchase of renewable energy from within the local area (organization, address), (3) promoting the development and the extent of local RES production and the storage of RE – restricted as an activity from within the local area.*

*[2] examples: (1) a photovoltaic supply (PV) has been installed, (2) there is an electricity installation (meter) available (3) connected to the common electricity grid, (4) a battery for storing electricity has been installed, (5) the supply electricity has been contracted.*

*[3] (however, see suggestion in § 9.3)*

**§ 5. CAPITAL MANAGEMENT**

- 5.1 The Management Board shall ensure that the Cooperative’s capital response is solid at all times.  
5.2 The capital needed to finance the business of the Cooperative which the Cooperative does not itself possess can be made accessible by taking loans.  
5.3 As security for the financing of the Cooperative’s business and security in accordance with § 5.2, the Cooperative may utilize the assets of the Cooperative.

**§ 6. MEMBERS COUNCIL**

- 6.1 The Members Council is the highest authority of the Cooperative and shall be composed of up to xx representatives and up to xx alternate members for each electoral area. The Cooperative’s supply area is divided in xx electoral areas, aiming to ensure that each electoral area elects at least xx and no more than xx members to the council. The details of the electoral areas shall be in accordance with the provisions of § 6.10. Representatives and alternate members shall be elected by and among the Cooperative’s members.  
6.2 The right to vote shall lie with any member of the Cooperative. Each member may give one vote [4].  
6.3 Electable to the Members Council is any member of the Cooperative. The right of the member of the Cooperative to be elected may be transferred to a member of his or her household or co-owner. If the member is a legal person, any person who is a member of its senior management is electable. A person may have only one candidature. A person must be of adult age to be electable.  
6.4 Employees of the Cooperative or of the Cooperative’s external suppliers cannot be elected to the Members Council.  
6.5 The Cooperative operates independently of organizations, companies and public institutions and must not be subject to general instructions from these in case they are members of the Cooperatives. Instructions may be given only to the member of the Cooperative representing the organization, the company and/or the public institution.  
6.6 Representatives shall be elected for x years at a time and must take up duties at the ordinary Members Council Meeting held after the elections to the Members Council.  
6.7 The elections shall be held at the same time in all elec-

*[4] examples of an increased proportion of votes are as follows: (1) where the member has several meters; (2) if the member has several photovoltaic installations; (3) if the member has several storage facilities, but there should be a maximum number of votes for such members, stated by the following addition: however, maximum xx votes.*

toral areas and shall be implemented at latest at the xx of the election year.

6.8 If a representative does not (longer) satisfy the conditions for being a representative, cf. §s 6.3-6.5 of the Statutes, the representative must step back from the date on which the conditions are not (longer) met and replaced by an alternate member. The same applies if the representative withdraws for other reasons.

6.9 In the event of a serious breach by a representative of his/her representative obligations, the Management Board may decide to exclude him/her from the Members Council. The excluded representative can request that the Management Board's decision is presented at meeting of the Members Council, in accordance with Paragraph 7.10.

6.10 The detailed electoral procedures and the definitive breakdown of the electoral areas shall be determined in accordance with the provisions of the "Cooperatives Election Provisions" to be attached as Annex 1 to these Statutes. Changes in these provisions can only be made in accordance with the rules in § 7.11 and 7.12.

## § 7. MEMBERS COUNCIL MEETING

7.1 The ordinary Members Council Meeting shall be held annually no later than the end of May in the year in question.

7.2 Extraordinary Members Council meetings shall be held when at least xx Management Board members find it necessary or when at least xx representatives in the Members Council send a written requests about this. Extraordinary Members Council Meetings to address a particular topic shall be convened by the Management Board at the latest within xx weeks of receipt of the request.

7.3 All Mmbers Council Meetings must be convened by letter, e-mail or any other electronic medium following the decision of the Management Board. The call shall be sent to each representative, with at least xx weeks and up to a maximum of xx weeks' notice attached to the full agenda and supporting documents, to be examined and, where appropriate, to be approved at the meeting, as well as the complete proposals (when relevant). However, the annual accounts and the budget may be sent at the latest by the xx days before the representative meeting. Extraordinary meetings may be convened at shorter notice, which though at least must be xx.

7.4 The agenda of the ordinary members meeting shall

include:

1. Election of a chair and rapporteur
2. Report by the Management Board on the Cooperative's activities in the past year
3. Submission of the audited annual report for approval
4. Decision on how outcomes are to be used (profit/loss)
5. Presentation of the next year's budget for approval
6. Consideration of proposals received from the representatives
7. Election of Management Board members and alternate members
8. Choice of auditor/chartered accountant
9. Any other business

Any proposal to be examined at the Members Council Meeting shall be submitted in writing to the Management Board in due time to allow the inclusion on the agenda of the Members Council Meeting. In this respect, proposals received by the Management Board before the end of (x month) shall always be considered in time.

7.5 At a Members Council meeting, decisions can only be taken on the proposals that have been on the agenda and amendments to these, unless all the representatives are personally (without a power of attorney) present and consent.

7.6 Minutes of the Members Council meeting have to be taken to written protocol. The minutes must be signed by the chair of the meeting. A representative who does not agree with the decision made at the Members Council Meeting is entitled to have additional remarks included in the protocol. The minutes shall be circulated in copy to all the representatives as soon as possible after the meeting. The Members Council decides whether to publish the minutes in whole or in part.

7.7 The negotiations at the Members Council are chaired by a chair, who must be elected by the Members Council. The chair decides on all questions relating to the treatment, vote and results of the present cases.

7.8 Each representative shall have one vote.

7.9 A representative may appear and vote through a single proxy who is appointed representative. A representative may only be mandated by one other representative. The power of attorney, which may only be given to one specific Members Council meeting, shall be written, dated, signed by the principal and clear.

7.10 The matters handled at the Members Council are

decided upon by a simple majority among the present representatives (by appearance or represented by a power of attorney), unless these statutes specify special votes. In the event of a tie, the proposal shall be terminated, however the selection of the auditor can be handled by lot.

7.11 For the purposes of the adoption of a proposal to change these statutes, voting provisions or the dissolution of the Cooperative, at least two thirds of the representatives are present (by appearance or by power of attorney) at the Members Council meeting and that two thirds of the representatives present at the meeting are voting in favor of the proposal.

7.12 If, in connection with a proposal covered by § 7.11, the Members Council meeting does not represent at least two thirds of the representatives but two thirds of the representatives actually represented votes in favor of the proposal, the meeting shall be convened at the earliest xx days and no later than xx weeks thereafter, in which case the proposal may be adopted by two-thirds of the votes cast, irrespective of the number of present representatives.

## § 8. MANAGEMENT BOARD

8.1 The Cooperative is managed by a board which, under the responsibility to the Members Council, is heading the business and strategic management of the Cooperative and ensures a sound organization of the Cooperative's business.

8.2 The Management Board comprise of xx members and up to xx alternate members, elected by and among the representatives of the Members Council at the ordinary Members Council meeting referred in § 7.4 for a period of xx years at a time. Members of the Management Board shall be elected for x years at any one time, x in one year and x in the following year.

8.3 The Management Board constitutes itself at the first board meeting following the election by appointing a chair and a vice-chair.

8.4 The Management Board adopts by itself its rules of procedure, which shall include the detailed provisions convening meetings, the agenda and process of the meetings as well as the activities of the Management Board. The Management Board shall meet as often as necessary and, moreover, when the chairman or the vice-chair considers it necessary, or when xx members of the Management Board so requires.

8.5 Quorum of the Management Board demands that more than half of the members of the board are present. Its decisions are taken by a simple majority of votes. In the event of a tie, the chair has the casting vote.

8.6 A protocol of the Management Board meetings must be recorded. The minutes must be signed by all members present. Members who are not present or present will have to sign the protocol subsequently. A member of the Management Board who does not agree with the decision made by the boards has the right to have his/her opinion entered into the protocol.

8.7 The protocol must be available at any meeting of the Management Board and any protocol input has to be signed by all members of the board.

8.8 The Management Board may employ necessary assistance.

## § 9. SPECIAL DECISIONS

9.1 Decisions to merge, divide or dissolve the Cooperative demands qualified majority in the Members Council as mentioned in the articles of § 7.11 and 7.12.

9.2 Other significant exceptional actions, including investments, divestments or liquidation of activities or assets, require the adoption of the Members Council by a simple majority of their representatives at the meeting, in accordance with § 7.10.

9.3 [5] (to be inserted by a provision with any deletions)

## § 10. POWER TO BIND

10.1 The power to bind the Cooperative rests by the chair and another board member in concert or by the entire Management Board.

10.2 The Management Board may grant procuration.

## § 11. ACCOUNTING AND FINANCIAL AUDIT

11.1 The Cooperative's financial year is the calendar year.

11.2 The annual report shall be audited by one of the Members Council for one year at a time elected auditor or chartered accountant.

## § 12. DISPOSITION OF PROFIT

*[5] At the discretion of the Management Board, the settlement amount to members shall be retained until 5 % of the amount to an operation fund.*

*The amount withheld can be remunerated with an interest rate set by the board. The Management Board shall, when approving the annual report, decide on a yearly basis on whether to make payments from the operation fund and on what amounts, while, in the event of a resignation, the operating fund for a member shall be paid out over a maximum period of x years (the amount of the specific annual payments shall also be determined in the situation of the Management Board each year as described above). The decision of the Management Board shall be approved by the Members Council in the course of its approval of the annual report, cf. § 7.4. In the case of a member's commitment to the Cooperative, it may be offset against the members credit balance on the operating funds' accounts. Assets and future profits arising from the future operation of the Cooperative may be given/donated over xx years to Associations, stakeholder organizations, corporations or other legal entities for the performance of a task/activity that is in line with the purpose of the Cooperative for general environmental, social and/or economic activities within the Cooperative field or to leave it in the Cooperative as long as this exists. Unused funds may be carried over to the following financial year.*

12.1 Any profit in the Cooperative cannot be distributed among the members but are to be used for the purpose of the Cooperative.

Options 1 to 12.1: The Members Council decides based on a recommendation from the Management Board, disposition of profits or losses. The Members Council decides, following the recommendation of the Management Board, the distribution to the members of the Cooperative. The distribution to the members has to be in proportion to each member's turnover in relation to the Cooperative.

Options 2 til 12.1: The Members Council, acting on a recommendation from the Management Board, decides on the disposition of profits or losses. The Members Council decides, following the recommendation of the Management Board, the distribution to members or the provision for consolidation in accordance with § 9.3. Distribution to the members has to be in proportion to the turnover of each member in relation to the Cooperative.

## § 13. LIQUIDATION

13.1 In case the conditions demand the Cooperative to be dissolved, the Management Board must present a proposal to that effect at a Members Council meeting.

13.2 A decision on dissolving the Cooperative by liquidation must be taken by the Members Council in accordance with the same rules as amendments to the statutes referred to in § 7. 11 and 7.12.

13.3 The Members Council appoints one or more liquidators to handle the dissolution of the Cooperative, to settle the liability of the Cooperative and to the realization of its assets.

13.4 If, after the Cooperative's liabilities have been met, assets remain, the Members Council decides on the use of these assets within the scope of the Cooperative's purpose, without the option for the Members Council to distribute the assets to members.

Alternative to 13.4: If, following the liquidation of the Cooperative's liabilities, a profit remains, at first the members of the Cooperative and eventual earlier members are paid for the shares of the operating fund, cf. § 9.3 and 12.1 (alternatives). In addition, any surplus beyond this must be distributed among the members in proportion to their turnover in relation to the Cooperative which reflects the shares of the operating fund, cf. § 9.3 and 12.1.



Climate-KIC

Climate-KIC is supported by the EIT, a body of the European Union

