

## MA450 - SERIES

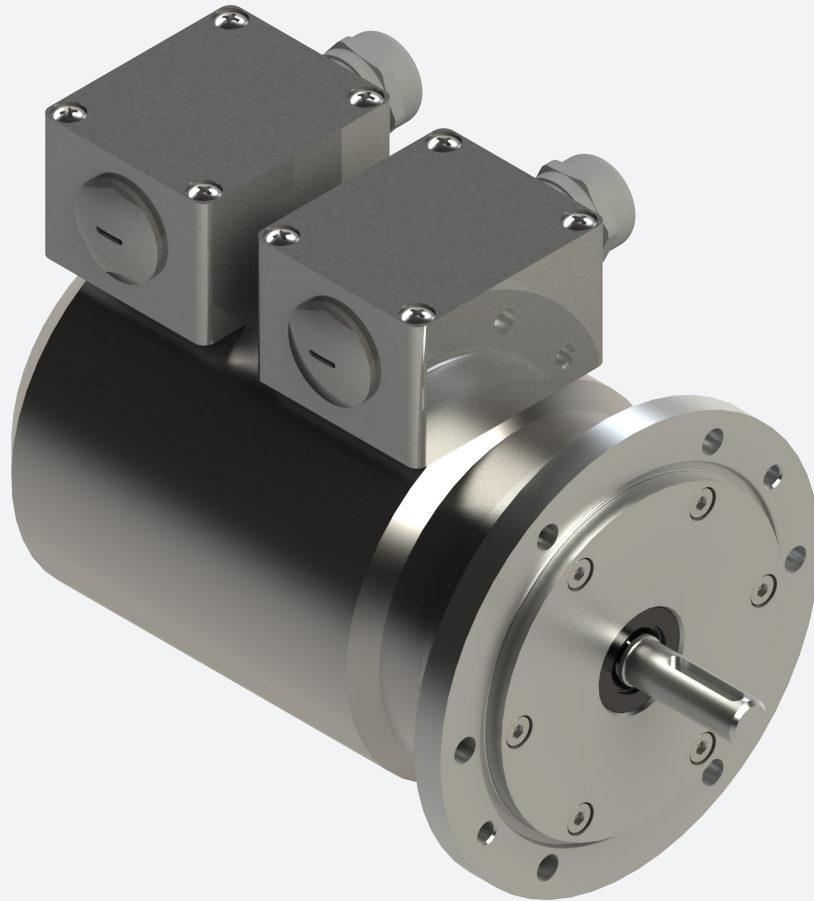

### HEAVY DUTY ENCODER WITH OVERSPEED Ø 115 MM

*Encoder with EURO-flange B10 in stainless steel AISI 316*

- Offshore and salt water firm
- Fixed switching speed based on a centrifugal principle
- Switch with insulated make and break contact
- Enlarged sturdy bearings
- Combination of incremental encoder + overspeed switch
- Short circuit and reversed polarity proof
- Dust and splash proof IP67
- Optional anodized aluminium enclosure

The logo for emeta encoders, featuring a stylized blue wave icon to the left of the text 'emeta' in a bold, black, sans-serif font, with 'encoders' in a smaller, blue, sans-serif font below it.

*Flexible and durable  
encoder for demanding  
applications*

 File E342441



Conforms to european EMC directive  
89/336/EEC standards:  
EN61000-6-4 emission in industrial environments  
EN61000-6-2 immunity in industrial environments

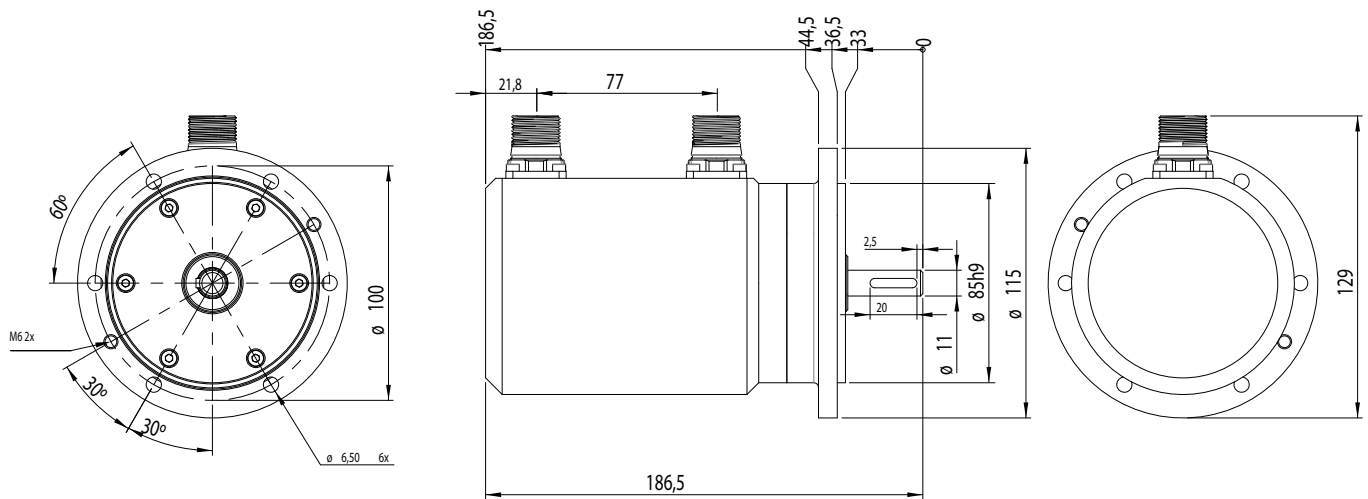

### ELECTRICAL SPECIFICATIONS, INCREMENTAL ENCODER

Electronic option	T (TTL)	H (HTL)
Supply voltage	5 Vdc	5–30 Vdc (SELV)
Current consumption	Max 40 mA without load	
Output circuit	Linedriver RS422A compatible	
Low level output volt.	Max <0,5 V at 20 mA load and 20°C	
High level output volt.	Min >Vcc-1V at 20mA load and 20°C	
Short circuit protected	Yes	
Polarity protected	Yes	
Transient protected	Yes	
Max load	70 mA	

### OUTPUT SIGNALS, STANDARD

CCW rotation viewed from shaft end

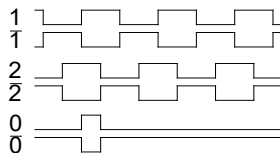

### SIGNAL ACCURACY

Dividing error max	±50 el°
Channel separation	90 ± 20 el°
Max frequency	300 kHz
Operating temperature	-40° .. + 80°C

### MECHANICAL SPECIFICATION

Housing	Stainless Steel AISI 316
Shaft	Stainless Steel 1.4057
Sealing	IP67 dust and splash proof
Bearings	Permanently greased
Bearing load at	1 000 rpm
Radial	<350 N
Axial	<250 N
Max rpm	12000
Weight	5,5 kg (AISI316), 2,2 kg (Aluminium)

### CONNECTION

A	M23 Male Connector, CCW, Radial 12-pin
C	Terminal box for ø6 mm - ø12 mm cable

### FUNCTION

Signal	A (M23)	C (Terminal)
<b>1</b>	5	4
<b>2</b>	8	6
<b>0</b>	3	8
<b>1 inverted</b>	6	5
<b>2 inverted</b>	1	7
<b>0 inverted</b>	4	9
<b>+E V</b>	12	1
<b>0 V</b>	10	2
<b>+E V sense</b>	2	-
<b>0 V sense</b>	11	-
<b>Gnd</b>	Chassis	Chassis

### MATING CONNECTOR

12-pin M23 Female Connector, CW

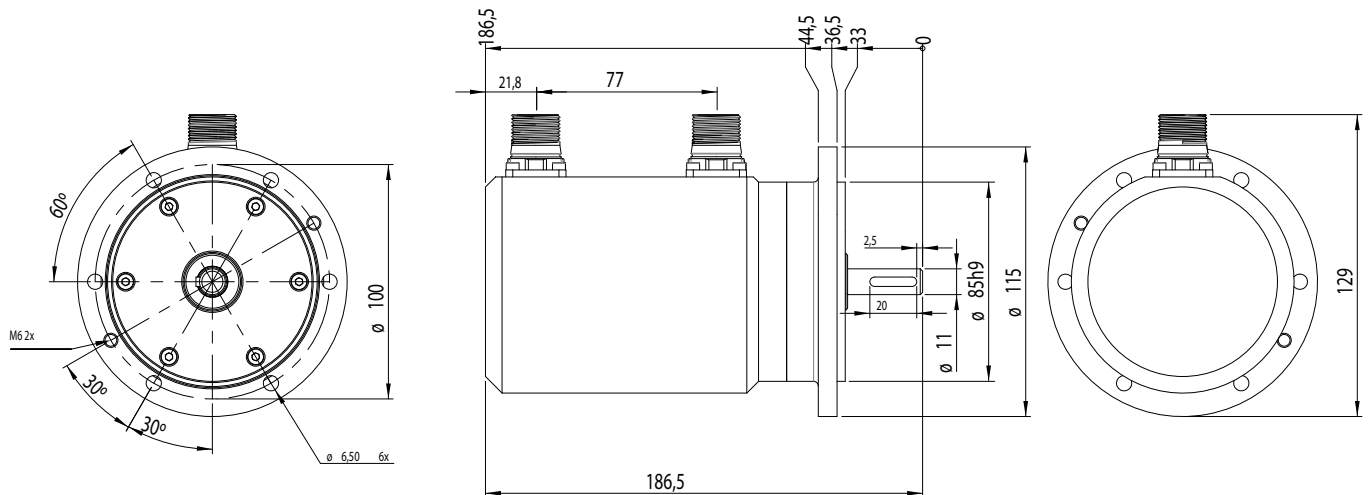

## ELECTRICAL SPECIFICATIONS

Switching speed (n)	800 ... 4000 rpm	(pre-defined value)
Overspeed principle	Mechanical centrifugal type	
Switching accuracy	$n \pm 75$ rpm	(standard)
Switching hysteresis	Approx. 40 - 65 % of switching speed	
Switching deviation	< 3 %	(cw - ccw rotation)
Mechanical lifetime	500.000 cycles	
Max. rpm	5000 rpm	
Contact type	Open / Close	
Output switching capacity	22 A / 230 Vac	(short time)
	3 A / 230 Vac	(continuous)

## CONNECTION TYPE

A	M23 Male, CW, 6 pin
C	Terminal box for $\phi 6\text{mm}-\phi 12\text{mm}$ cable

## FUNCTION

Signal	A (M23)	C (Terminal box)
A	1	1
B	2	2
C	3	3
D	4	4
Gnd	Chassis	Chassis

## OVERSPEED OUTPUT DESCRIPTION

When  $\text{rpm} < n_{\text{limit}}$

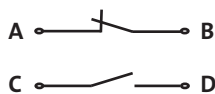

When  $\text{rpm} > n_{\text{limit}}$

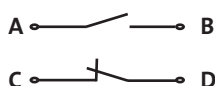

## ORDERING KEY

Model - Material - Connection - Encoder - Overspeed

Model	MA450	
Material	A	Aluminium enclosure
	S	Stainless steel enclosure
Connection	A	M23 Connector
	C	Terminal box ( $\phi 6\text{mm}-\phi 12\text{mm}$ cable)
Encoder	xxxxx	Type definition, as described below
Overspeed	nnnn	Type definition, as described below

## TYPE DEFINITION ENCODER

Electronics	T	TTL
	H	HTL
Resolution	1 .. 2500	

## TYPE DEFINITION OVERSPEED

Interface	R	Overspeed
Limit value	nnnn	rpm

## Sample ordering key

MA450-SA-T1024-R1000 (1 x incremental, 1000 rpm)  
 MA450-SC-H2048-R2500 (1 x incremental, 2500 rpm)