



NOVAWINCH.COM

ZHEJIANG NOWVOW MECHANICAL & ELECTRICAL CORP.,LTD

1689 Xianyuan Road, Jinhua Zhejiang China

0086-579-82262697

E-mail : info@nowvow.net



Find Us Here [NOVAWINCH](#)



DISTRIBUTED BY:

© NOVAWINCH™ is registered trademark of NOWVOW Mechanical& Electrical Corp.,ltd. Specifications subjects to change at anytime.

 **NOVAWINCH**<sup>®</sup>  
EXPERIENCE AMAZING



2022-2023  
**PRODUCT GUIDE**



# ENTERPRISE PROFILE

Since 1997, the world has sought NOVAWINCH products because of our dedication to quality and customer service. Manufacturing hundreds of thousands of winches each year, our team of professionals continue to break new barriers and build the most amazing winches year after year.



TOP LEVEL WINCH TESTING LAB IN CHINA



FIRST ELECTRIC WINCH MANUFACTURER IN CHINA



100+ COMPREHENSIVE APPLICATION COVERAGE



PARTNERS IN MORE THAN 30 COUNTRIES



NOVAWINCH's production facilities meet or exceed global certification standards. We hold ourselves and our products to a higher standard.



# CONTENTS

## ELECTRIC WINCHES

PRO MAX SERIES (14500lb-18500lb) .....	01-04
PRO SERIES (9500lb-12500lb) .....	05-06
T SERIES LARGE FRAME (12500lb-18500lb) .....	07-09
T SERIES MIDDLE FRAME (8000lb-12500lb) .....	10-12
FENIX SERIES (2500lb-4500lb).....	13-16
T SERIES SMALL FRAME (2500lb-4500lb) .....	17-20
COMPACT HOIST (500lb-1000lb) .....	21-23

## HYDRAULIC WINCHES

TORO SERIES (22000lb) .....	25-26
HEN SERIES (8000lb-18000lb) .....	27-31
HEN MAX SERIES (22000lb-45000lb) .....	32-37

## DISTINCTIVE PRODUCTS

PORTABLE TOOL .....	38
MINI MOVER .....	39

## ACCESSORIES

# THE PERFECT COMPANION FOR YOUR JOB AND ADVENTURE



If your job demands performance and reliability, the Novawinch PRO Series is for you. This innovative series is the market leader for jobs that demand the toughest of performance winches to run at top speed job after job.

## PRO MAX SERIES

### 14500-18500lb

The NOVAWINCH PRO Series is built to be the very best winch using the very best in performance parts. From exclusive designs like our industry-first brake that doesn't heat the rope drum to excitingly fast line speed and so much more.

#### ADVANCED ELECTRONICS

Waterproof and tough 500A contactor

**8X** longer runtime  
Advanced electronics increase winch capabilities

#### DURABLE

Large drum diameter reduces rope wear

#### PERMANENT

Anti-rust black zinc-plated hardware

#### SUPER-STOPPER

Best-in-class brake system



#### RELIABLE

Industrial grade rubber switch

#### POWERFUL

High torque, durable and sealed electric motor

#### NOVAWINCH

#### IP68 RATED

Waterproof seal protection



Synthetic rope optional



2-in-1 remote optional



Double-lock brake system



Safe but fast line speeds



Anti-rust black zinc-plated hardware



IP68 Rated water protection



Large diameter drum prolongs rope life



Industrial-Grade controls



SUS304 stainless steel roller fairlead

# PRO MAX SERIES

# PRO MAX SERIES

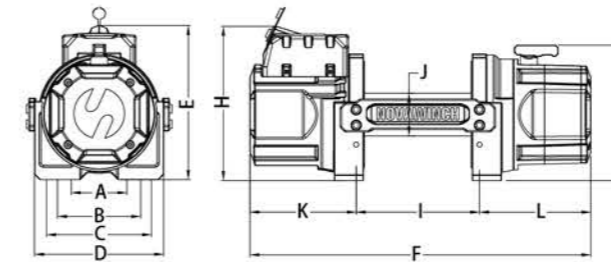
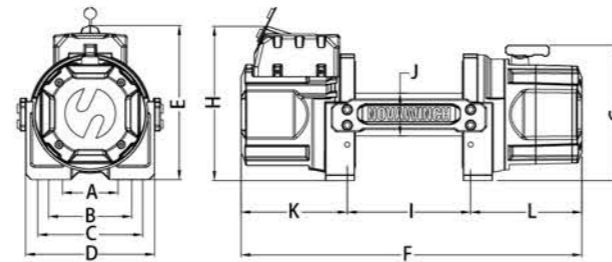
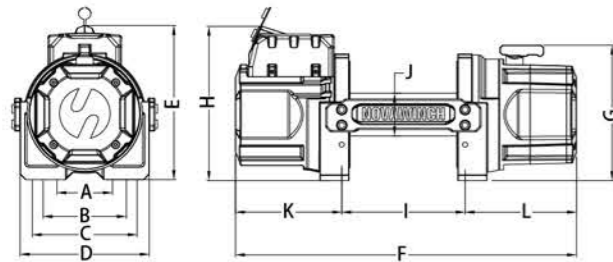

A=4.50"(114mm)	F=27.76"(705mm)	G=10.98"(279mm)
B=6.50"(165mm)	H=12.52"(318mm)	I=10"(254mm)
C=8.50"(216mm)	J=Φ3.46"(88mm)	K=8.66"(220mm)
D=10.47"(266mm)	L=9.09"(231mm)	
E=12.52"(318mm)		

A=4.50"(114mm)	F=27.76"(705mm)	G=10.98"(279mm)
B=6.50"(165mm)	H=12.52"(318mm)	I=10"(254mm)
C=8.50"(216mm)	J=Φ3.46"(88mm)	K=8.66"(220mm)
D=10.47"(266mm)	L=9.09"(231mm)	
E=12.52"(318mm)		

A=4.50"(114mm)	F=27.76"(705mm)	G=10.98"(279mm)
B=6.50"(165mm)	H=12.52"(318mm)	I=10"(254mm)
C=8.50"(216mm)	J=Φ3.46"(88mm)	K=8.66"(220mm)
D=10.47"(266mm)	L=9.09"(231mm)	
E=12.52"(318mm)		



## PRO14500

### SPECIFICATIONS:

- Rated line pull:** 14500lb(6577kg) single line
- Motor(Series wound):**  
DC 12V: 4.2hp/3.2kW DC 24V: 5.0hp/3.8kW
- Gear train:** 2 stage Spur, 2 stage Planetary. 505:1 Ratio
- Clutch:** Rotating ring gear, 90° turn lever
- Braking action:** Automatic in gearbox
- Drum size:** 3.46"×8.66"(88mm×220mm)
- Handheld Control:**  
Waterproof rubber remote with metal plug, 12.7' (3.9m) cord
- Rope size:** 29/64"×92"(11.5mm×28m)
- Winch Dimension:**  
27.76" L. ×10.47" W. ×12.52" H. (705mm L. ×266mm W. ×318mm H.)
- Mounting Bolt pattern:**  
10"×4.5"(254mm×114mm) 10"×6.5"(254mm×165mm)  
10"×8.5"(254mm×216mm)
- Winch weight:** 170lb(77kg)

### 12V DC Line speed and motor current (first layer)

Line pull		Line speed		Motor current
lb	kg	FPM	MPM	Amps
0	0	18	5.5	40
14500	6577	3.9	1.2	270

### 24V DC Line speed and motor current (first layer)

Line pull		Line speed		Motor current
lb	kg	FPM	MPM	Amps
0	0	20	6.1	40
14500	6577	3.9	1.2	160

## PRO16500

### SPECIFICATIONS:

- Rated line pull:** 16500lb(7484kg) single line
- Motor(Series wound):**  
DC 12V: 5.6hp/4.2kW DC 24V: 5.2hp/3.9kW
- Gear train:** 2 stage Spur, 2 stage Planetary. 505:1 Ratio
- Clutch:** Rotating ring gear, 90° turn lever
- Braking action:** Automatic in gearbox
- Drum size:** 3.46"×8.66"(88mm×220mm)
- Handheld Control:**  
Waterproof rubber remote with metal plug, 12.7' (3.9m) cord
- Rope size:** 15/32"×92"(12mm×28m)
- Winch Dimension:**  
27.76" L. ×10.47" W. ×12.52" H. (705mm L. ×266mm W. ×318mm H.)
- Mounting Bolt pattern:**  
10"×4.5"(254mm×114mm) 10"×6.5"(254mm×165mm)  
10"×8.5"(254mm×216mm)
- Winch weight:** 176lb(80kg)

### 12V DC Line speed and motor current (first layer)

Line pull		Line speed		Motor current
lb	kg	FPM	MPM	Amps
0	0	18	5.5	40
16500	7484	3.6	1.1	330

### 24V DC Line speed and motor current (first layer)

Line pull		Line speed		Motor current
lb	kg	FPM	MPM	Amps
0	0	20.3	6.2	50
16500	7484	3.6	1.1	180

## PRO18500

### SPECIFICATIONS:

- Rated line pull:** 18500lb(8391kg) single line
- Motor(Series wound):**  
DC 12V: 4.9hp/3.7kW DC 24V: 5.9hp/4.5kW
- Gear train:** 2 stage Spur, 2 stage Planetary. 505:1 Ratio
- Clutch:** Rotating ring gear, 90° turn lever
- Braking action:** Automatic in gearbox
- Drum size:** 3.46"×8.66"(88mm×220mm)
- Handheld Control:**  
Waterproof rubber remote with metal plug, 12.7' (3.9m) cord
- Rope size:** 1/2"×82"(13mm×25m)
- Winch Dimension:**  
27.76" L. ×10.47" W. ×12.52" H. (705mm L. ×266mm W. ×318mm H.)
- Mounting Bolt pattern:**  
10"×4.5"(254mm×114mm) 10"×6.5"(254mm×165mm)  
10"×8.5"(254mm×216mm)
- Winch weight:** 181lb(82kg)

### 12V DC Line speed and motor current (first layer)

Line pull		Line speed		Motor current
lb	kg	FPM	MPM	Amps
0	0	18.7	5.7	50
18500	8391	3.2	1.0	310

### 24V DC Line speed and motor current (first layer)

Line pull		Line speed		Motor current
lb	kg	FPM	MPM	Amps
0	0	19.6	6.0	50
18500	8391	3.9	1.2	190

## 9500-12500lb

The NOVAWINCH PRO Series is built to be the very best winch using the very best in performance parts. From exclusive designs like our industry-first brake that doesn't heat the rope drum to excitingly fast line speed and so much more.

### SUPER

Fast line speeds, 16MPM with 50 Amps current when no load

### HIGH QUALITY

Laser-etched aluminum tie bars, stainless steel parts

### SUPER-STOPPER

Exclusive "double-lock" isolates heat in gearbox

### RELIABLE

Industrial grade rubber switch

### SUPER STRONG

Welded drum is superior to flimsy cast aluminum



Synthetic rope optional



2-in-1 remote optional



Double-lock brake system



Convertible control box

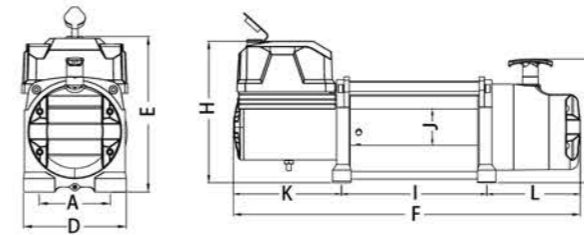

A=4.50"(114mm)	F=23.86"(606mm)	G=8.54"(217mm)
D=6.77"(172mm)	H=9.84"(250mm)	I=10"(254mm)
E=9.84"(250mm)	J=Φ2.48"(63mm)	K=7.44"(189mm)
	L=6.42"(163mm)	

## PRO9500

### SPECIFICATIONS:

**Rated line pull:** 9500lb(4309kg) single line  
**Motor(Series wound):** DC 12V: 6.0hp/4.4kW DC 24V: 6.4hp/4.8kW  
**Gear train:** 2 Stage Spur, 2 Stage Planetary. 171:1 Ratio  
**Clutch:** Pull and turn  
**Braking action:** Automatic in gearbox  
**Drum size:** 2.48"×8.74"(63mm×222mm)  
**Handheld Control:** Waterproof rubber remote, 12.7' (3.9m) cord  
**Rope size:** 3/8"×85.3'(9.2mm×26m)  
**Winch Dimension:** 23.86" L. ×6.77" W. ×9.84" H. (606mm L. ×172mm W. ×250mm H.)  
**Mounting Bolt pattern:** 10"×4.5"(254mm×114mm)  
**Net Weight:** 93.6lb(42.5kg)

### 12V DC Line speed and motor current (first layer)

Line pull		Line speed		Motor current
lb	kg	FPM	MPM	Amps
0	0	52.5	16	50
9500	4309	4.3	1.3	360

### 24V DC Line speed and motor current (first layer)

Line pull		Line speed		Motor current
lb	kg	FPM	MPM	Amps
0	0	52.5	16	30
9500	4309	4.9	1.7	200

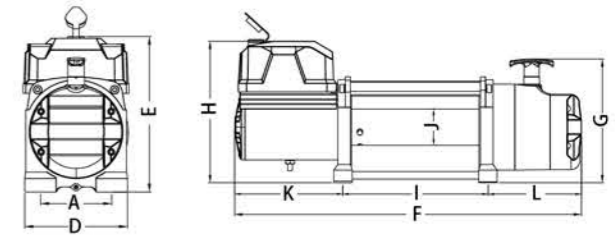

A=4.50"(114mm)	F=23.86"(606mm)	G=8.54"(217mm)
D=6.77"(172mm)	H=9.84"(250mm)	I=10"(254mm)
E=9.84"(250mm)	J=Φ2.48"(63mm)	K=7.44"(189mm)
	L=6.42"(163mm)	

## PRO12500

### SPECIFICATIONS:

**Rated line pull:** 12500lb(5670kg) single line  
**Motor(Series wound):** DC 12V: 6.4hp/4.7kW DC 24V: 7.5hp/5.7kW  
**Gear train:** 2 Stage Spur, 2 Stage Planetary. 171:1 Ratio  
**Clutch:** Pull and turn  
**Braking action:** Automatic in gearbox  
**Drum size:** 2.48"×8.74"(63mm×222mm)  
**Handheld Control:** Waterproof rubber remote, 12.7' (3.9m) cord  
**Rope size:** 3/8"×85.3'(9.2mm×26m)  
**Winch Dimension:** 23.86" L. ×6.77" W. ×9.84" H. (606mm L. ×172mm W. ×250mm H.)  
**Mounting Bolt pattern:** 10"×4.5"(254mm×114mm)  
**Net Weight:** 96lb(43.5kg)

### 12V DC Line speed and motor current (first layer)

Line pull		Line speed		Motor current
lb	kg	FPM	MPM	Amps
0	0	49.2	15	50
12500	5670	3.3	1	390

### 24V DC Line speed and motor current (first layer)

Line pull		Line speed		Motor current
lb	kg	FPM	MPM	Amps
0	0	49.2	15	30
12500	5670	3.3	1.3	260

# PERFORMANCE COMES STANDARD

Legendary performance meets genuine durability. For over 12 years, the Novawinch T Series has been tested all over the globe - from challenging mountains, gritty deserts, mucky mud and everything in between. When it comes down to a serious winch, choose Novawinch.

## T LARGE FRAME

### 12500-18000lb

Novawinch T-Series is our workhorse series featuring proven parts and great performance. Novawinch's experience in building world class winches brings innovative concepts to this high-performance and affordable range without sacrificing reliability.

#### SMART

Waterproof and tough 500A contactor

#### TRUSTED

Engineered to be dependable and affordable

#### CLEVER

4 stage planetary gear

#### SUPER-STOPPER

100% load holding brake

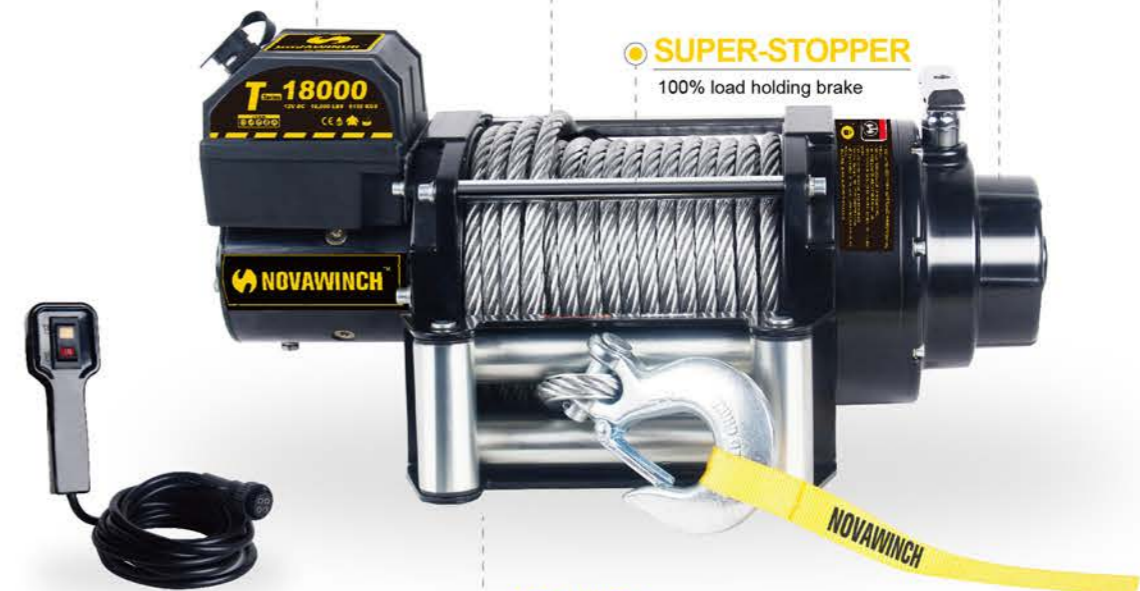

#### QUALITY

4-way roller fairlead



Synthetic rope optional



2-in-1 remote optional



Sealed to keep out water and dirt. Ultra-heavy-duty silver contacts keep the Novawinch contactor running at lower temperatures



Chrome plated pull and turn freespool control is ergonomic and looks great



Relocatable control box makes installation easily



2 optional location for the control box to fit different space

# T LARGE FRAME

# T MIDDLE FRAME

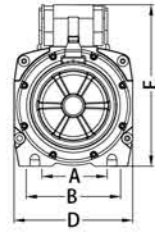

A=4.50"(114mm) B=6.50"(165mm)  
D=8.46"(215mm) E=11.34"(288mm)

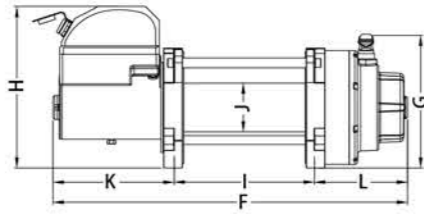

F=25.28"(642mm) G=9.92"(252mm)  
H=11.34"(288mm) I=10"(254mm)  
J=Φ3.46"(88mm) K=8.62"(219mm)  
L=6.65"(169mm)

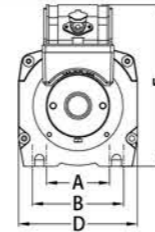

A=4.50"(114mm) B=6.50"(165mm)  
D=8.46"(215mm) E=11.34"(288mm)

## NVT12500

### SPECIFICATIONS:

**Rated line pull:** 12500lb(5670kg) single line  
**Motor(Series wound):**  
DC 12V: 5.0hp/3.8kW DC 24V: 7.0hp/5.3kW  
**Gear train:** 4 stage planetary gear. 516:1 Ratio  
**Clutch:** Pull and turn  
**Braking action:**  
Mechanical, Automatic load holding  
**Drum size:** 3.46"×8.66"(88mm×220mm)  
**Handheld Control:**  
Waterproof handheld remote, 12.7' (3.9m) cord  
**Rope size:** 13/32"×95"(10.3mm×29m)  
**Winch Dimension:**  
25.28" L. ×8.46" W. ×11.34" H.  
(642mm L. ×215mm W. ×288mm H.)  
**Mounting Bolt pattern:**  
10"×4.5"(254mm×114mm)  
10"×6.5"(254mm×165mm)  
**Net Weight:** 145.5lb(66kg)

### 12V DC Line speed and motor current (first layer)

Line pull		Line speed		Motor current
lb	kg	FPM	MPM	Amps
0	0	11.5	3.5	90
12500	5670	3.9	1.2	320

### 24V DC Line speed and motor current (first layer)

Line pull		Line speed		Motor current
lb	kg	FPM	MPM	Amps
0	0	11.8	3.6	70
12500	5670	4.3	1.3	220

## NVT15000

### SPECIFICATIONS:

**Rated line pull:** 15000lb(6804kg) single line  
**Motor(Series wound):**  
DC 12V: 6.0hp/4.5kW DC 24V: 7.3hp/5.5kW  
**Gear train:** 4 stage planetary gear. 516:1 Ratio  
**Clutch:** Pull and turn  
**Braking action:**  
Mechanical, Automatic load holding  
**Drum size:** 3.46"×8.66"(88mm×220mm)  
**Handheld Control:**  
Waterproof handheld remote, 12.7' (3.9m) cord  
**Rope size:** 29/64"×92"(11.5mm×28m)  
**Winch Dimension:**  
25.28" L. ×8.46" W. ×11.34" H.  
(642mm L. ×215mm W. ×288mm H.)  
**Mounting Bolt pattern:**  
10"×4.5"(254mm×114mm)  
10"×6.5"(254mm×165mm)  
**Net Weight:** 150lb(68kg)

### 12V DC Line speed and motor current (first layer)

Line pull		Line speed		Motor current
lb	kg	FPM	MPM	Amps
0	0	12.4	3.8	95
15000	6804	3.3	1.0	380

### 24V DC Line speed and motor current (first layer)

Line pull		Line speed		Motor current
lb	kg	FPM	MPM	Amps
0	0	12.7	3.9	80
15000	6804	3.9	1.2	230

## NVT18000

### SPECIFICATIONS:

**Rated line pull:** 18000lb(8165kg) single line  
**Motor(Series wound):**  
DC 12V: 6.6hp/5.0kW DC 24V: 8.2hp/6.2kW  
**Gear train:** 4 stage planetary gear. 516:1 Ratio  
**Clutch:** Pull and turn  
**Braking action:**  
Mechanical, Automatic load holding  
**Drum size:** 3.46"×8.66"(88mm×220mm)  
**Handheld Control:**  
Waterproof handheld remote, 12.7' (3.9m) cord  
**Rope size:** 1/2"×82"(13mm×25m)  
**Winch Dimension:**  
25.28" L. ×8.46" W. ×11.34" H.  
(642mm L. ×215mm W. ×288mm H.)  
**Mounting Bolt pattern:**  
10"×4.5"(254mm×114mm)  
10"×6.5"(254mm×165mm)  
**Net Weight:** 154lb(70kg)

### 12V DC Line speed and motor current (first layer)

Line pull		Line speed		Motor current
lb	kg	FPM	MPM	Amps
0	0	13.1	4.0	95
18000	8165	2.6	0.8	420

### 24V DC Line speed and motor current (first layer)

Line pull		Line speed		Motor current
lb	kg	FPM	MPM	Amps
0	0	13.7	4.2	80
18000	8165	3.3	1.0	260

## 8000-12000lb

Novawinch T-Series is our workhorse series featuring proven parts and great performance. Novawinch's experience in building world class winches brings innovative concepts to this high-performance and affordable range without sacrificing reliability.

### SMART

500A sealed contactor

### TRUSTED

Engineered to be dependable and affordable

### SUPER-STOPPER

100% load holding brake

### POWERFUL

3 stage planetary gear



### QUALITY

4-way roller fairlead



Synthetic rope optional



2-in-1 remote optional



Bridge control box optional



Sealed to keep out water and dirt. Ultra-heavy-duty silver contacts keep the Novawinch contactor running at lower temperatures



Chrome plated pull and turn freespool control is ergonomic and looks great



Relocatable control box makes installation easy



2 optional location for the control box to fit different space



# T MIDDLE FRAME

# T MIDDLE FRAME

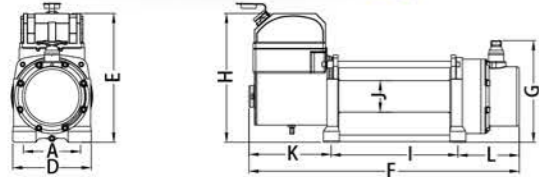

A=4.50"(114mm) F=22.36"(568mm) G=7.99"(203mm)  
 D=6.22"(158mm) H=10.24"(260mm) I=10"(254mm)  
 E=10.24"(260mm) J=Φ2.48"(63mm) K=7.56"(192mm)  
 L=4.8"(122mm)

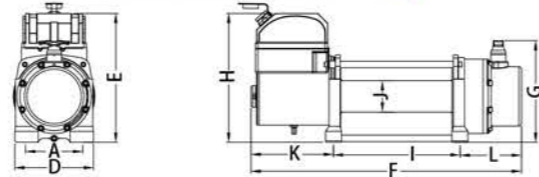

A=4.50"(114mm) F=22.36"(568mm) G=7.99"(203mm)  
 D=6.22"(158mm) H=10.24"(260mm) I=10"(254mm)  
 E=10.24"(260mm) J=Φ2.48"(63mm) K=7.56"(192mm)  
 L=4.8"(122mm)

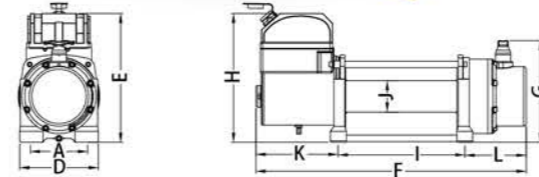

A=4.50"(114mm) F=22.36"(568mm) G=7.99"(203mm)  
 D=6.22"(158mm) H=10.24"(260mm) I=10"(254mm)  
 E=10.24"(260mm) J=Φ2.48"(63mm) K=7.56"(192mm)  
 L=4.8"(122mm)

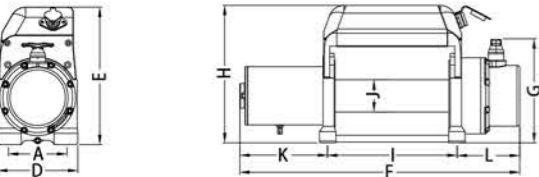

A=4.50"(114mm) F=22.36"(568mm) G=7.99"(203mm)  
 D=6.22"(158mm) H=10.63"(270mm) I=10"(254mm)  
 E=10.63"(270mm) J=Φ2.48"(63mm) K=7.56"(192mm)  
 L=4.8"(122mm)

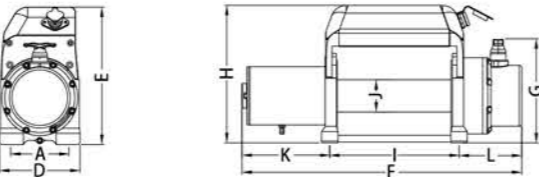

A=4.50"(114mm) F=22.36"(568mm) G=7.99"(203mm)  
 D=6.22"(158mm) H=10.63"(270mm) I=10"(254mm)  
 E=10.63"(270mm) J=Φ2.48"(63mm) K=7.56"(192mm)  
 L=4.8"(122mm)

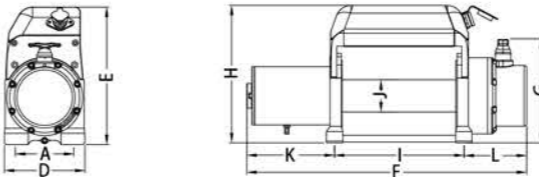

A=4.50"(114mm) F=22.36"(568mm) G=7.99"(203mm)  
 D=6.22"(158mm) H=10.63"(270mm) I=10"(254mm)  
 E=10.63"(270mm) J=Φ2.48"(63mm) K=7.56"(192mm)  
 L=4.8"(122mm)

## NVT8000/NVT8000S

### SPECIFICATIONS:

**Rated line pull:** 8000lb(3629kg) single line  
**Motor(Series wound):**  
 DC 12V: 5.6hp/4.2kW DC 24V: 5.8hp/4.3kW  
**Gear train:** 3 stage planetary gear. 196:1 Ratio  
**Clutch:** Pull and turn  
**Braking action:** Mechanical, Automatic load holding  
**Drum size:** 2.48"×8.8"(63mm×224mm)  
**Handheld Control:** Waterproof handheld remote, 12.7' (3.9m) cord  
**Rope size:** 5/16"×95' (8.1mm×29m)  
**Winch Dimension:**  
 22.36" L. ×6.22" W. ×10.24" H. (568mm L. ×158mm W. ×260mm H.)  
 22.36" L. ×6.22" W. ×10.63" H. (568mm L. ×158mm W. ×270mm H.)  
**Mounting Bolt pattern:** 10"×4.5"(254mm×114mm)  
**Net Weight:** 88lb(40kg) 92.6lb(42kg)

### 12V DC Line speed and motor current (first layer)

Line pull		Line speed		Motor current
lb	kg	FPM	MPM	Amps
0	0	20.3	6.2	80
8000	3629	5.6	1.7	360

### 24V DC Line speed and motor current (first layer)

Line pull		Line speed		Motor current
lb	kg	FPM	MPM	Amps
0	0	17.7	5.4	60
8000	3629	6.6	2.0	175

## NVT10000/NVT10000S

### SPECIFICATIONS:

**Rated line pull:** 10000lb(4536kg) single line  
**Motor(Series wound):**  
 DC 12V: 6.3hp/4.5kW DC 24V: 6.9hp/5.2kW  
**Gear train:** 3 stage planetary gear. 196:1 Ratio  
**Clutch:** Pull and turn  
**Braking action:** Mechanical, Automatic load holding  
**Drum size:** 2.48"×8.8"(63mm×224mm)  
**Handheld Control:** Waterproof handheld remote, 12.7' (3.9m) cord  
**Rope size:** 3/8"×85.3'(9.2mm×26m)  
**Winch Dimension:**  
 22.36" L. ×6.22" W. ×10.24" H. (568mm L. ×158mm W. ×260mm H.)  
 22.36" L. ×6.22" W. ×10.63" H. (568mm L. ×158mm W. ×270mm H.)  
**Mounting Bolt pattern:** 10"×4.5"(254mm×114mm)  
**Net Weight:** 89.3lb(40.5kg) 93.7lb(42.5kg)

### 12V DC Line speed and motor current (first layer)

Line pull		Line speed		Motor current
lb	kg	FPM	MPM	Amps
0	0	20.6	6.3	80
10000	4536	5.2	1.6	380

### 24V DC Line speed and motor current (first layer)

Line pull		Line speed		Motor current
lb	kg	FPM	MPM	Amps
0	0	17.7	5.4	70
10000	4536	5.6	1.7	220

## NVT12000/NVT12000S

### SPECIFICATIONS:

**Rated line pull:** 12000lb(5443kg) single line  
**Motor(Series wound):**  
 DC 12V: 7.3hp/5.5kW DC 24V: 8.2hp/6.2kW  
**Gear train:** 3 stage planetary gear. 196:1 Ratio  
**Clutch:** Pull and turn  
**Braking action:** Mechanical, Automatic load holding  
**Drum size:** 2.48"×8.8"(63mm×224mm)  
**Handheld Control:** Waterproof handheld remote, 12.7' (3.9m) cord  
**Rope size:** 3/8"×85.3'(9.2mm×26m)  
**Winch Dimension:**  
 22.36" L. ×6.22" W. ×10.24" H. (568mm L. ×158mm W. ×260mm H.)  
 22.36" L. ×6.22" W. ×10.63" H. (568mm L. ×158mm W. ×270mm H.)  
**Mounting Bolt pattern:** 10"×4.5"(254mm×114mm)  
**Net Weight:** 90.4lb(41kg) 94.8lb(43kg)

### 12V DC Line speed and motor current (first layer)

Line pull		Line speed		Motor current
lb	kg	FPM	MPM	Amps
0	0	20.6	6.3	80
12000	5443	3.6	1.1	460

### 24V DC Line speed and motor current (first layer)

Line pull		Line speed		Motor current
lb	kg	FPM	MPM	Amps
0	0	15.1	4.6	70
12000	5443	3.6	1.1	260

## NOVAWINCH T-SERIES WINCH COMPARE WITH COMPETITORS

### STRONGER MOTORS



Competitors



NOVAWINCH

Larger, stronger Novawinch motor armature will run cooler and is more efficient.

### BETTER DRUMS



Competitors



NOVAWINCH

Upgraded Novawinch extruded spline is stronger and enlarged for more efficient power transfer.

### UPGRADED COPPER CABLES



Competitors



NOVAWINCH

Upgraded Novawinch battery cables provide more efficient power.

### STRONGER, WIDER GEARSET



Competitors



NOVAWINCH

Novawinch gearset is larger, features more teeth for better engagement and longer service life.



# READY FOR ACTION



NOVAWINCH FENIX Series is built to be the no-holds-barred best winch in powersports and for utility needs. Using the very best parts that are in a league in of their own, we built a winch that wins again and again.

## FENIX SERIES

### 2500-4500lb

We built the FENIX line to be the best winch at any price. From visibly better high-torque motors to quality large-diameter power transfer splines to cut metal gears (vs their powdered metal), at every turn the FENIX Series is designed to perform better and longer than any other winch, period.

#### POWERFUL

High torque and fast cooling electric motor

#### STRONG

Steel reinforced drums on both wire and synthetic rope versions

#### SMART

Ergonomic cam action freespool clutch knob ensures easy operation



#### OPTIONAL

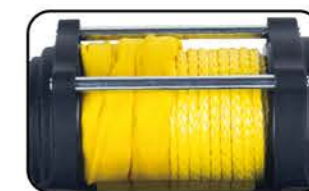

Dyneema synthetic rope

#### QUALITY

304 stainless steel hardware for longer service life

#### HIGH EFFICIENCY

Low amp draw, sealed permanent magnet motor featuring mechanical load holding and dynamic brake.

#### INTENSITY

All steel planetary gear is twice as wide compared to the competition and is enhanced with machined-in oil pocket bronze bearings.

#### WATER RESISTANCE

Extreme IP68 water protection for motor, gearbox and drum.

#### SECURITY

Water sealed contactor with circuit breaker protection.



# FENIX SERIES

# FENIX SERIES



## Standard Accessories:



Wired control and Rocker switch



Contactor



Socket



Cable assy kit



Circuit breaker



Mounting plate

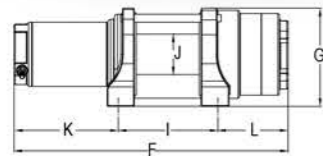

F=13.31"(338mm) G=4.84"(123mm) I=4.9"(124mm)  
J=Φ2.0"(50mm) K=4.96"(126mm) L=3.46"(88mm)

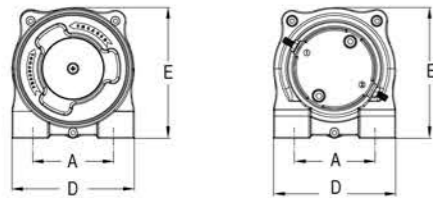

A=3.0"(76mm) A=3.0"(76mm)  
D=4.53"(115mm) D=4.53"(115mm)  
E=4.84"(123mm) E=4.84"(123mm)

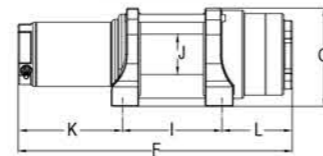

F=13.50"(343mm) G=4.84"(123mm) I=4.9"(124mm)  
J=Φ2.0"(50mm) K=5.16"(131mm) L=3.46"(88mm)

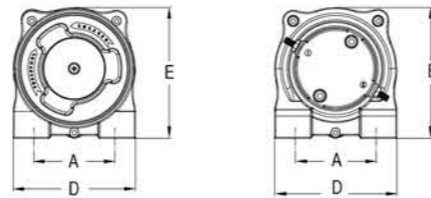

A=3.0"(76mm) A=3.0"(76mm)  
D=4.53"(115mm) D=4.53"(115mm)  
E=4.84"(123mm) E=4.84"(123mm)

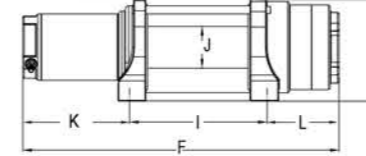

F=15.24"(387mm) G=4.84"(123mm) I=6.6"(168mm)  
J=Φ2.0"(50mm) K=5.16"(131mm) L=3.46"(88mm)

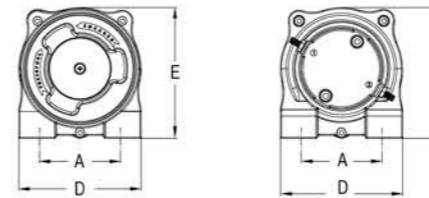

A=3.0"(76mm) A=3.0"(76mm)  
D=4.53"(115mm) D=4.53"(115mm)  
E=4.84"(123mm) E=4.84"(123mm)

## FENIX2500

### SPECIFICATIONS:

**Rated line pull:** 2500lb(1135kg) single line  
**Motor(Permanent magnet):** DC 12V: 3.0hp/2.3kW  
**Gear ratio:** 3 stage planetary gear. 140:1 Ratio  
**Clutch:** Ergonomic Control  
**Braking action:** Mechanical, Automatic load holding  
**Drum Size:** 2.0" x 3.1" (50mm x 78mm)  
**Handheld Control:**  
Waterproof handheld remote, 9.85' (3.0m) cord  
Waterproof Mini-rocker remote, 9.85' (3.0m) cord  
**Rope size:** 3/16" x 50'(4.8mm x 15.2m)  
**Winch Dimension:**  
13.31" L. x 4.53" W. x 4.84" H. (338mm L. x 115mm W. x 123mm H.)  
**Mounting Bolt Pattern:** 4.9"x3"(124mmx76mm)  
**Net Weight:** 26.5lb (12kg)

### 12V DC Line speed and motor current (first layer)

Line pull		Line speed		Motor current
lb	kg	FPM	MPM	Amps
0	0	26.0	7.9	25
2500	1135	10.5	3.2	190

## FENIX3500

### SPECIFICATIONS:

**Rated line pull:** 3500lb(1589kg) single line  
**Motor(Permanent magnet):** DC 12V: 4.1hp/3.1kW  
**Gear ratio:** 3 stage planetary gear. 140:1 Ratio  
**Clutch:** Ergonomic Control  
**Braking action:** Mechanical, Automatic load holding  
**Drum Size:** 2.0" x 3.1" (50mm x 78mm)  
**Handheld Control:**  
Waterproof handheld remote, 9.85' (3.0m) cord  
Waterproof Mini-rocker remote, 9.85' (3.0m) cord  
**Rope size:** 7/32" x 50'(5.4mm x 15.2m)  
**Winch Dimension:**  
13.50" L. x 4.53" W. x 4.84" H. (343mm L. x 115mm W. x 123mm H.)  
**Mounting Bolt Pattern:** 4.9"x3"(124mmx76mm)  
**Net Weight:** 28.6lb (13kg)

### 12V DC Line speed and motor current (first layer)

Line pull		Line speed		Motor current
lb	kg	FPM	MPM	Amps
0	0	24.0	7.3	35
3500	1589	10.2	3.1	260

## FENIX4500

### SPECIFICATIONS:

**Rated line pull:** 4500lb(2043kg) single line  
**Motor(Permanent magnet):** DC 12V: 3.7hp/2.8kW  
**Gear ratio:** 3 stage planetary gear. 191:1 Ratio  
**Clutch:** Ergonomic Control  
**Braking action:** Mechanical, Automatic load holding  
**Drum Size:** 2.0" x 4.9" (50mm x 122mm)  
**Handheld Control:**  
Waterproof handheld remote, 9.85' (3.0m) cord  
Waterproof Mini-rocker remote, 9.85' (3.0m) cord  
**Rope size:** 15/64" x 55.7'(6.0mm x 17m)  
**Winch Dimension:**  
15.24" L. x 4.53" W. x 4.84" H. (387mm L. x 115mm W. x 123mm H.)  
**Mounting Bolt Pattern:** 6.6"x3"(168mmx76mm)  
**Net Weight:** 33 lb (15kg)

### 12V DC Line speed and motor current (first layer)

Line pull		Line speed		Motor current
lb	kg	FPM	MPM	Amps
0	0	15.0	4.6	32
4500	2043	5.5	1.7	230

# NOTHING CAN GET IN YOUR WAY

## T SMALL FRAME

### 2500-4500lb

Novawinch T-Series is our workhorse series featuring proven parts and great performance. Novawinch's experience in building world class winches brings innovative concepts to this high-performance and affordable range without sacrificing reliability.

#### POWERFUL

High efficiency electric motor, clockable for best fit

#### SEALED

IP67 water protection

#### ERGONOMIC

Patented unique automatic spring brake is 100% reliable even in full load operation

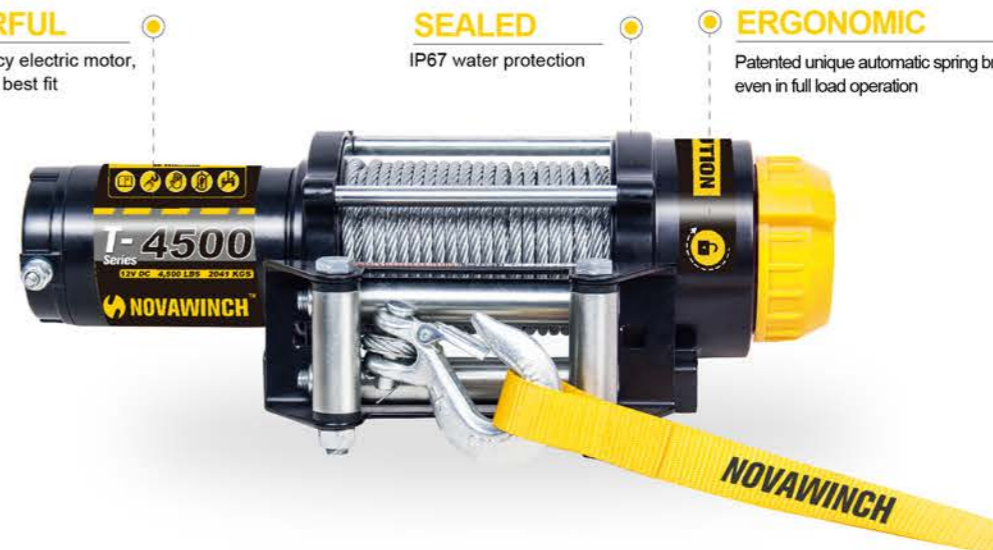

#### HIGH EFFICIENCY

Low amp draw, sealed permanent magnet motor featuring mechanical load holding and dynamic brake.

#### OPTIONS

Available in classic wire rope or synthetic rope.

#### WATER RESISTANCE

Extreme IP67 water protection for motor, gearbox and drum.

#### MULTIPLE APPLICATION

Applicable for powersports and utility.



The T-Series Lineup has all the features you want with the durability and reliability you need. With pulling capacities from 2500-4500lbs, the T series features an all-metal chassis engineered for long life and low maintenance. The Novawinch T-Series offers industrial winch performance in a compact package to conquer even the toughest situations.

# T SMALL FRAME

# T SMALL FRAME

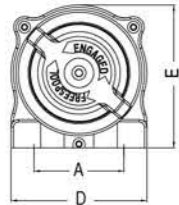

A=3.0"(76mm) D=4.53"(115mm)  
E=4.76"(121mm)

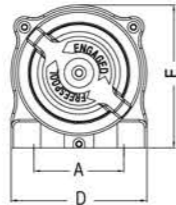

A=3.0"(76mm) D=4.53"(115mm)  
E=4.76"(121mm)

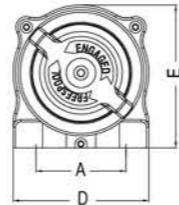

A=3.0"(76mm) D=4.53"(115mm)  
E=4.76"(121mm)

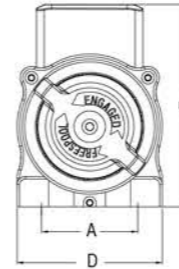

A=3.0"(76mm) D=4.53"(115mm)  
E=6.30"(160mm)

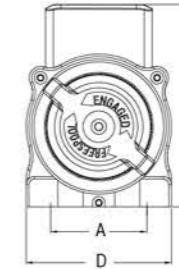

A=3.0"(76mm) D=4.53"(115mm)  
E=6.30"(160mm)



A=3.0"(76mm) D=4.53"(115mm)  
E=6.30"(160mm)

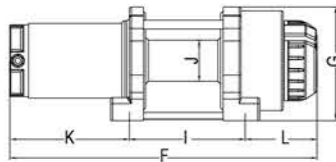

F=12.95"(329mm) G=4.76"(121mm)  
I=4.9"(124mm) J=Φ1.73"(44mm)  
K=5.04"(128mm) L=3.03"(77mm)

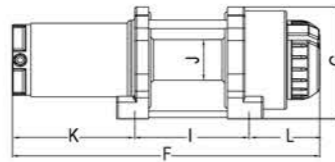

F=13.15"(334mm) G=4.76"(121mm)  
I=4.9"(124mm) J=Φ1.73"(44mm)  
K=5.24"(133mm) L=3.03"(77mm)

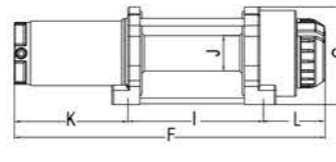

F=15.20"(386mm) G=4.76"(121mm)  
I=6.6"(168mm) J=Φ1.73"(44mm)  
K=5.55"(141mm) L=3.03"(77mm)

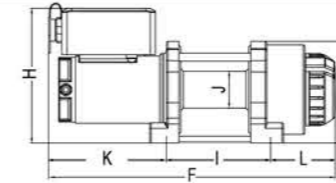

F=13.43"(341mm) G=4.76"(121mm)  
H=6.30"(160mm) I=4.9"(124mm)  
J=Φ1.73"(44mm) K=5.51"(140mm)  
L=3.03"(77mm)

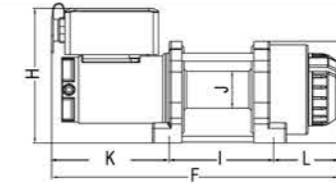

F=13.62"(346mm) G=4.76"(121mm)  
H=6.30"(160mm) I=4.9"(124mm)  
J=Φ1.73"(44mm) K=5.71"(145mm)  
L=3.03"(77mm)

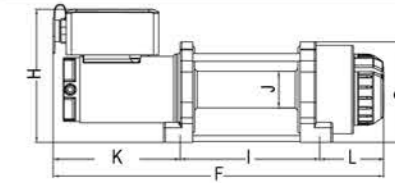

F=15.67"(398mm) G=4.76"(121mm)  
H=6.30"(160mm) I=6.6"(168mm)  
J=Φ1.73"(44mm) K=6.02"(153mm)  
L=3.03"(77mm)

## NVT2500

### SPECIFICATIONS:

**Rated line pull:** 2500lb(1135kg) single line  
**Motor (Permanent magnet):**  
DC 12V: 2.4hp/1.8kW  
**Gear train:** 3 stage planetary gear, 180:1 Ratio  
**Clutch:** Sliding ring gear  
**Braking action:**  
Mechanical, Automatic load holding  
**Drum size:** 1.73"×3.15"(44mm×80mm)  
**Handheld Control:**  
Waterproof handheld remote, 9.85' (3.0m) cord  
Waterproof Mini-rocker remote, 9.85' (3.0m) cord  
**Rope size:** 3/16"×45.9"(4.8mm×14m)  
**Dimensions:**  
12.95" L. ×4.53" W. ×4.76" H.  
(329mm L. ×115mm W. ×121mm H.)  
**Bolt pattern:** 4.9"×3"(124mm×76mm)  
**Net Weight:** 26lb(11.8kg)

### 12V DC Line speed and motor current (first layer)

Line pull		Line speed		Motor current
lb	kg	FPM	MPM	Amps
0	0	13.1	4.0	26
2500	1135	5.9	1.8	150

## NVT3500

### SPECIFICATIONS:

**Rated line pull:** 3500lb(1589kg) single line  
**Motor (Permanent magnet):**  
DC 12V: 2.8hp/2.1kW  
**Gear train:** 3 stage planetary gear, 180:1 Ratio  
**Clutch:** Sliding ring gear  
**Braking action:**  
Mechanical, Automatic load holding  
**Drum size:** 1.73"×3.15"(44mm×80mm)  
**Handheld Control:**  
Waterproof handheld remote, 9.85' (3.0m) cord  
Waterproof Mini-rocker remote, 9.85' (3.0m) cord  
**Rope size:** 3/16"×45.9"(4.8mm×13.7m)  
**Dimensions:**  
13.15" L. ×4.53" W. ×4.76" H.  
(334mm L. ×115mm W. ×121mm H.)  
**Bolt pattern:** 4.9"×3"(124mm×76mm)  
**Net Weight:** 26.4lb(12kg)

### 12V DC Line speed and motor current (first layer)

Line pull		Line speed		Motor current
lb	kg	FPM	MPM	Amps
0	0	13.7	4.2	26
3500	1589	5.6	1.7	180

## NVT4500

### SPECIFICATIONS:

**Rated line pull:** 4500lb/2043kg single line  
**Motor (Permanent magnet):**  
DC 12V: 3.0hp/2.2kW  
**Gear train:** 3 stage planetary gear, 180:1 Ratio  
**Clutch:** Sliding ring gear  
**Braking action:**  
Mechanical, Automatic load holding  
**Drum size:** 1.73"×4.88"(44mm×124mm)  
**Handheld Control:**  
Waterproof handheld remote, 9.85' (3.0m) cord  
Waterproof Mini-rocker remote, 9.85' (3.0m) cord  
**Rope size:** 7/32"×55.8"(5.4mm×17m)  
**Dimensions:**  
15.20" L. ×4.53" W. ×4.76" H.  
(386mm L. ×115mm W. ×121mm H.)  
**Bolt pattern:** 6.6"×3"(168mm×76mm)  
**Net Weight:** 30.8lb(14kg)

### 12V DC Line speed and motor current (first layer)

Line pull		Line speed		Motor current
lb	kg	FPM	MPM	Amps
0	0	13.1	4.0	30
4500	2043	4.6	1.4	185

## NVT2500i

### SPECIFICATIONS:

**Rated line pull:** 2500lb(1135kg) single line  
**Motor (Permanent magnet):**  
DC 12V: 2.4hp/1.8kW  
**Gear train:** 3 stage planetary gear, 180:1 Ratio  
**Clutch:** Sliding ring gear  
**Braking action:**  
Mechanical, Automatic load holding  
**Drum size:** 1.73"×3.15"(44mm×80mm)  
**Handheld Control:**  
Waterproof handheld remote, 9.85' (3.0m) cord  
Waterproof Mini-rocker remote, 9.85' (3.0m) cord  
**Rope size:** 3/16"×45.9"(4.8mm×14m)  
**Dimensions:**  
13.43" L. ×4.53" W. ×6.30" H.  
(341mm L. ×115mm W. ×160mm H.)  
**Bolt pattern:** 4.9"×3"(124mm×76mm)  
**Net Weight:** 28.2lb(12.8kg)

### 12V DC Line speed and motor current (first layer)

Line pull		Line speed		Motor current
lb	kg	FPM	MPM	Amps
0	0	13.1	4.0	26
2500	1135	5.9	1.8	150

## NVT3500i

### SPECIFICATIONS:

**Rated line pull:** 3500lb(1589kg) single line  
**Motor (Permanent magnet):**  
DC 12V: 2.8hp/2.1kW  
**Gear train:** 3 stage planetary gear 180:1  
**Clutch:** Sliding ring gear  
**Braking action:**  
Mechanical, Automatic load holding  
**Drum size:** 1.73"×3.15"(44mm×80mm)  
**Handheld Control:**  
Waterproof handheld remote, 9.85' (3.0m) cord  
Waterproof Mini-rocker remote, 9.85' (3.0m) cord  
**Rope size:** 3/16"×45.9"(4.8mm×13.7m)  
**Dimensions:**  
13.62" L. ×4.53" W. ×6.30" H.  
(346mm L. ×115mm W. ×160mm H.)  
**Bolt pattern:** 4.9"×3"(124mm×76mm)  
**Net Weight:** 28.7lb(13kg)

### 12V DC Line speed and motor current (first layer)

Line pull		Line speed		Motor current
lb	kg	FPM	MPM	Amps
0	0	13.7	4.2	26
3500	1589	5.6	1.7	180

## NVT4500i

### SPECIFICATIONS:

**Rated line pull:** 4500lb/2043kg single line  
**Motor (Permanent magnet):**  
DC 12V: 3.0hp/2.2kW  
**Gear train:** 3 stage planetary gear, 180:1 Ratio  
**Clutch:** Sliding ring gear  
**Braking action:**  
Mechanical, Automatic load holding  
**Drum size:** 1.73"×4.88"(44mm×124mm)  
**Handheld Control:**  
Waterproof handheld remote, 9.85' (3.0m) cord  
Waterproof Mini-rocker remote, 9.85' (3.0m) cord  
**Rope size:** 7/32"×55.8"(5.4mm×17m)  
**Dimensions:**  
15.67" L. ×4.53" W. ×6.30" H.  
(398mm L. ×115mm W. ×160mm H.)  
**Bolt pattern:** 6.6"×3"(168mm×76mm)  
**Net Weight:** 33.1lb(15kg)

### 12V DC Line speed and motor current (first layer)

Line pull		Line speed		Motor current
lb	kg	FPM	MPM	Amps
0	0	13.1	4.0	30
4500	2043	4.6	1.4	185

# COMPACT HOIST

## 1000lb

Built with a 4:1 safety rating for lifting, the TH1000 is the right winch to safely lift and move materials. Features a steel spring tension plate to a tight wrap on the drum, the winch has full power in and power out and a full-load mechanical brake to ensure secure and easy operation.

### POWERFUL

High torque with faster cooling electric motor

### STRONG

Steel reinforced drums on both wire and synthetic rope versions

### NO FREESPOOL

To ensure gears remain engaged



**IP68**  
Waterproof

### SECURITY

Mechanical cone brake and permanent motor dynamic brakes together for safe, controlled load.

### PULL

Full metal 3 stage planetary gear train for greater pulling force.

### POWERFUL

Extremely IP68 water resistance on motor, gearbox and both drum sides.



# COMPACT HOIST

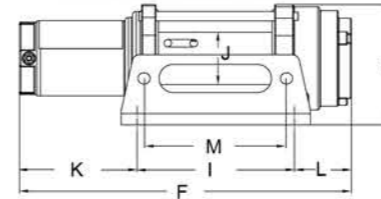

F=13.98"(355mm) H=5.08"(129mm) I=6.6"(168mm) J=2.20"(56mm)  
K=4.96"(126mm) L=2.40"(61mm) M=5.94"(151mm)

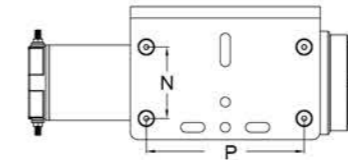

N=3.0"(76mm) P=6.6"(168mm)

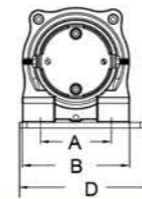

A=3.0"(76mm)  
B=4.53"(115mm)  
D=5.59"(142mm)

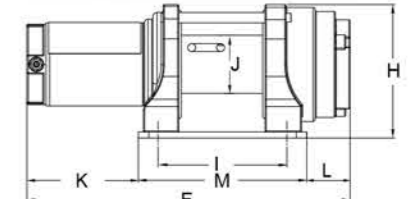

F=12.28"(312mm) H=5.08"(129mm) I=4.9"(124mm) J=2.20"(56mm)  
K=5.00"(127mm) L=2.40"(61mm) M=6.06"(154mm)

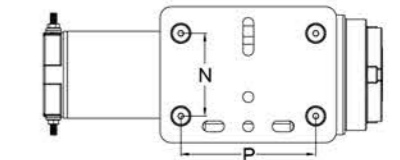

N=3.0"(76mm) P=4.9"(124mm)

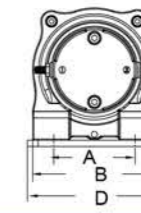

A=3.0"(76mm)  
B=4.53"(115mm)  
D=4.57"(116mm)

## TH1000

### SPECIFICATIONS:

**Rated line pull:** 1000lb(454kg) single line  
**Motor:** DC 12V: 1.6hp/1.2kW DC 24V: 1.3hp/1.0kW  
**Gear train:** 3 stage planetary gear. 140:1 Ratio  
**Clutch:** None  
**Braking action:** Mechanical, Automatic load holding  
**Drum size:** 2.2"x4.8"(56mmx122mm)  
**Handheld Control:** Waterproof rubber remote, 12.7' (3.9m) cord  
**Rope size:** 3/16"x60' (4.8mmx18.3m)  
**Winch Dimension:**  
13.98" L. x 5.59" W. x 5.08" H. ( 355mm L. x 142mm W. x 129mm H.)  
**Mounting Bolt Pattern:** 6.6"x3"(168mmx76mm)  
**Net Weight:** 24lb (11kg)

### 12V DC Line speed and motor current (first layer)

Line pull		Line speed		Motor current
lb	kg	FPM	MPM	Amps
0	0	14.7	4.5	30
1000	454	12.5	3.8	75

### 24V DC Line speed and motor current (first layer)

Line pull		Line speed		Motor current
lb	kg	FPM	MPM	Amps
0	0	17.1	5.2	15
1000	454	12.5	3.8	40

## TH1000SD

### SPECIFICATIONS:

**Rated line pull:** 1000lb(454kg) single line  
**Motor:** DC 12V: 1.6hp/1.2kW DC 24V: 1.3hp/1.0kW  
**Gear train:** 3 stage planetary gear. 140:1 Ratio  
**Clutch:** None  
**Braking action:** Mechanical, Automatic load holding  
**Drum size:** 2.2"x3.1"(56mmx78mm)  
**Handheld Control:** Waterproof rubber remote, 12.7' (3.9m) cord  
**Rope size:** 3/16"x46' (4.8mm x 14.0m)  
**Winch Dimension:**  
12.28" L. x 4.57" W. x 5.08" H. ( 312mm L. x 116mm W. x 129mm H.)  
**Mounting Bolt Pattern:** 4.9"x3"(124mmx76mm)  
**Net Weight:** 22 lb (10kg)

### 12V DC Line speed and motor current (first layer)

Line pull		Line speed		Motor current
lb	kg	FPM	MPM	Amps
0	0	14.7	4.5	30
1000	454	12.5	3.8	75

### 24V DC Line speed and motor current (first layer)

Line pull		Line speed		Motor current
lb	kg	FPM	MPM	Amps
0	0	17.1	5.2	15
1000	454	12.5	3.8	40

# COMPACT HOIST

500lb

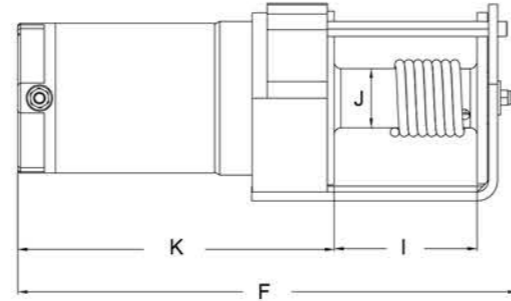

F=11.54"(293mm) I=2.87"(73mm)  
J=1.24"(31.5mm) K=6.65"(169mm)

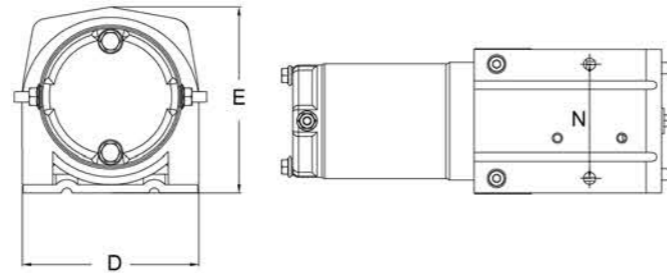

D=3.98"(101mm) N=3.11"(79mm)  
E=4.25"(108mm)

## CH500

### SPECIFICATIONS:

**Rated line pull:** 500lb(226kg) single line

**Motor (Permanent magnet):** DC 12V: 0.53hp/0.4kW

**Gear train:** 1 stage planetary gear, 153:1 Ratio

**Clutch:** None

**Braking action:** Differential self-locking

**Drum size:** 1.24"×2.88"(31.5mm×73mm)

**Handheld Control:**

Waterproof handheld remote, 5.9' (1.8m) battery cord, 4.3' (1.3m) motor cord

**Rope size:** 3/16"×15.7"(4.8mm ×4.8m)

**Winch Dimension:**

11.54" L. ×3.98" W. ×4.25" H.(293mm L. ×101mm W. ×108mm H.)

**Mounting Bolt pattern:** 3.13"(79.5mm)

**Net Weight:** 18.7lbs (8.5kgs)

### 12V DC Line speed and motor current (first layer)

Line pull		Line speed		Motor current
lb	kg	FPM	MPM	Amps
0	0	11.2	3.4	18
500	226	8.2	2.5	32



Makes lifting easy



Built to perform and maximize value



500lbs hoisting capability with a 4:1 safety factor



Compact and lightweight design



Direct connect remote control



# THE PERFECT COMPANION FOR RELIABILITY & DEPENDABILITY

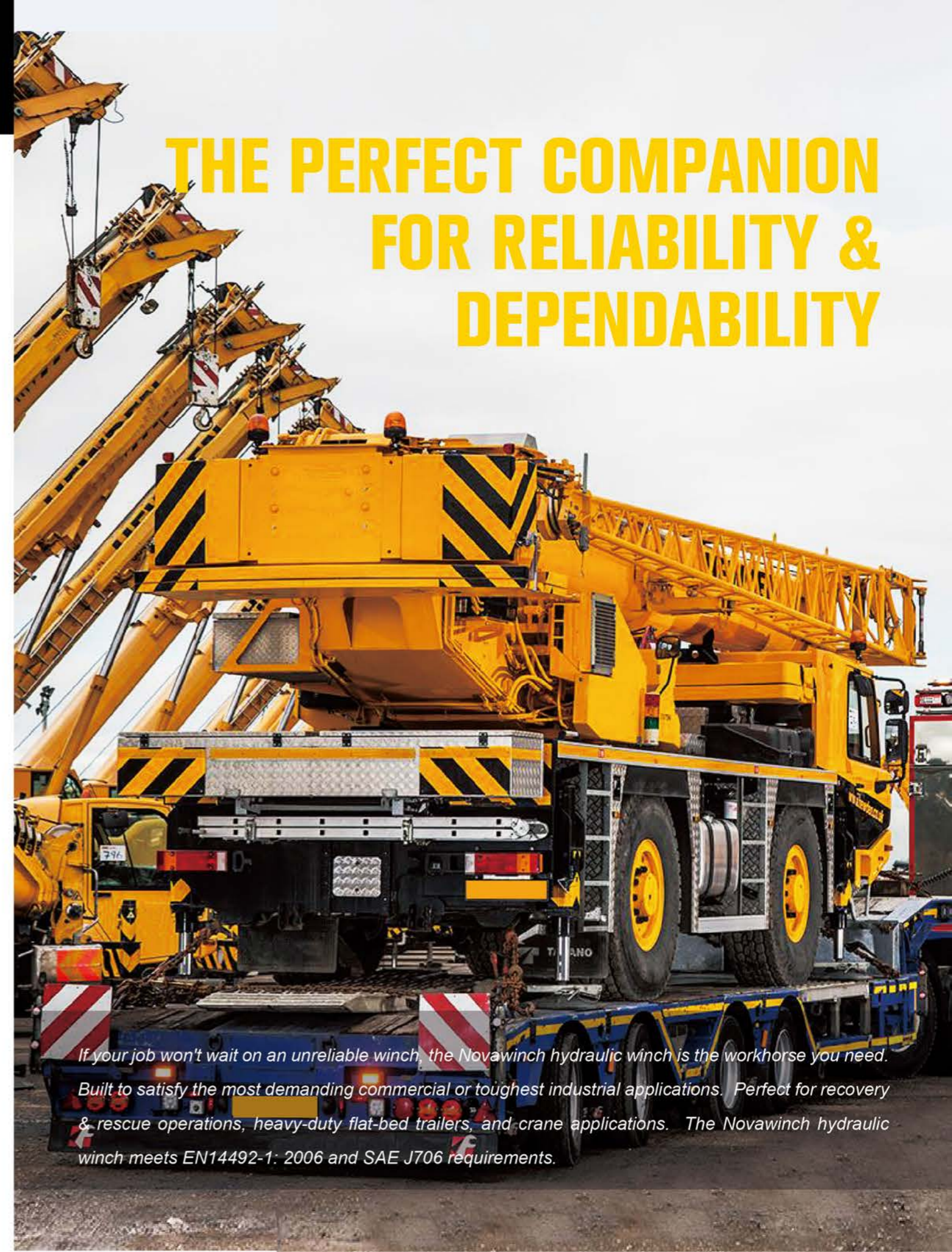

*If your job won't wait on an unreliable winch, the Novawinch hydraulic winch is the workhorse you need. Built to satisfy the most demanding commercial or toughest industrial applications. Perfect for recovery & rescue operations, heavy-duty flat-bed trailers, and crane applications. The Novawinch hydraulic winch meets EN14492-1: 2006 and SAE J706 requirements.*

## 22000lb

### UPGRADED

Stronger G 1/2" threads for oil hose connections and oil-bath gearbox

### SAFE

Amazing multi-discs brake for maximum stopping power

### COMPACT

Preponderant compact design satisfy different fitting site for easy installation

### SUPERIOR EFFICIENCY

Fitting bearing in planetary gear instead of general copper bush, improved power transmission efficiency

### RELIABLE

Smart dual balance valve for changing rope direction and tested to 125% rated load

### SUPER-STRONG

Oversized casting steel drum supports, hardened planetary gears and carbon steel tie bar

### SEALED

IP67 rated seals keep elements away



### OPTIONAL ACCESSORIES:



SWIVEL SAFETY HOOK



WIRE ROPE ASSEMBLY



HEAVY DUTY ROLLER FAIRLEAD



MANUAL CLUTCH



## TORO22000

### PNEUMATIC CLUTCH

Air pressure range (bar)	1~8
Ventilation volume (L/min)	1

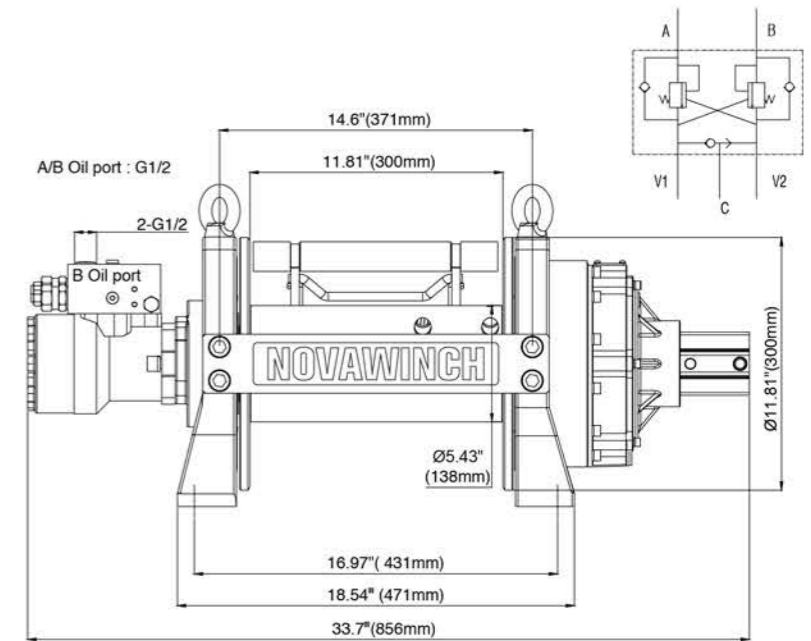
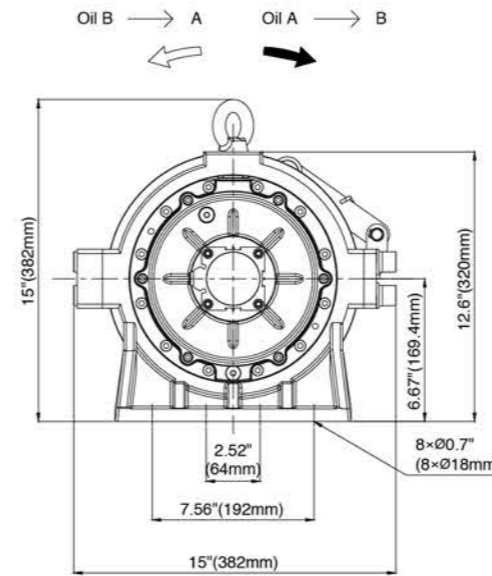

### SPECIFICATION

Model	First layer line pull		First layer line speed		Working pressure diff.		Oil flow supply	Gear ratio
	lbs	kg	fpm	mpm	psi	MPa	l/min	
<b>TORO22000</b>	22000	9979	23	7	2393	16.5	75	22.67:1

Model	Wire rope dia.		Layer	Wire rope capacity	
	inch	mm		ft	m
<b>TORO22000</b>	Φ35/64"	Φ14	4	157.5'	48

### PERFORMANCE

Model	TORO22000					
	Rated line pull per layer		Line speed		Wire rope capacity per layer	
Layer of cable	lbs	kg	fpm	mpm	ft	m
1	22000	9979	23	7	31.2'	9.5
2	18578	8425	27	8.3	68.2'	20.8
3	16077	7291	31	9.6	110.9'	33.8
4	14170	6426	36	10.9	157.5'	48

### NET WEIGHT(WITHOUT WIRE ROPE)

Model	Weight	
	lbs	kg
<b>TORO22000</b>	276	125

### WARNING:

1. Do not use winch to hoist people or objects over people.
2. Do not use clutch under load.
3. Winch system must include a relief valve.

### NOTE:

1. Recommended oil flow supply range is 35-90 l/min.
2. Independent oil supply system with relief valve is recommended.

## MEET EN14492-1:2006 REQUIREMENTS:

**125%**



Tested to 125% of rated line pull.

**X1.5**



Extra room between tie bars and drum – 1.5 x rope diameter.

**X2**



First layer of wire rope breaking strength is at least 2x of winch rated line pull.

**2 MOUNTING HOLES**



Two wire rope mounting holes on the drum for secure rope-drum connection.



## 8000-18000lb

### UPGRADED

Stronger G 1/2" threads for oil hose connections

### SAFE

Amazing multi-discs brake for maximum stopping power

### STRONG

Forged aluminum motor mounting plate, hardened planetary gears and carbon steel tie bar

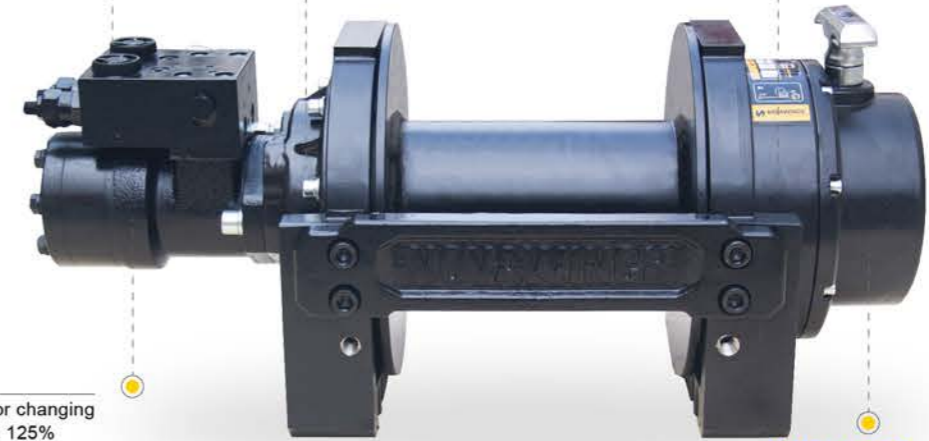

### RELIABLE

Smart dual balance valve for changing rope direction and tested to 125% rated load

### SEALED

IP67 rated seals keep elements away

## OPTIONAL ACCESSORIES:



WIRE ROPE TENSIONER



WIRE ROPE ASSEMBLY



HEAVY DUTY ROLLER FAIRLEAD



PNEUMATIC CLUTCH  
(6MM AIR TUBE CONNECTING HOLE)

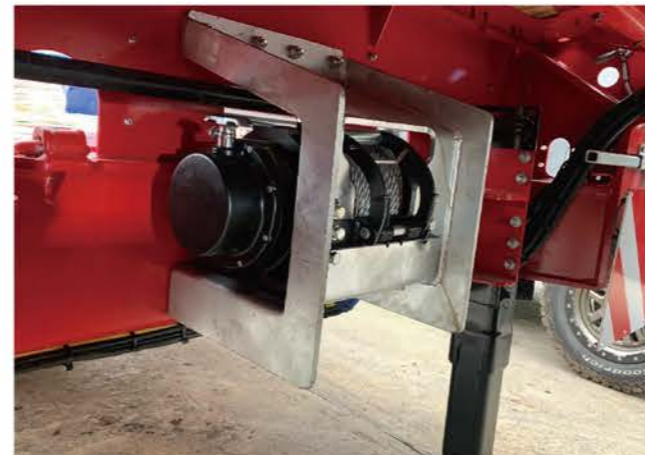



# HEN SERIES

## HEN8000-10000

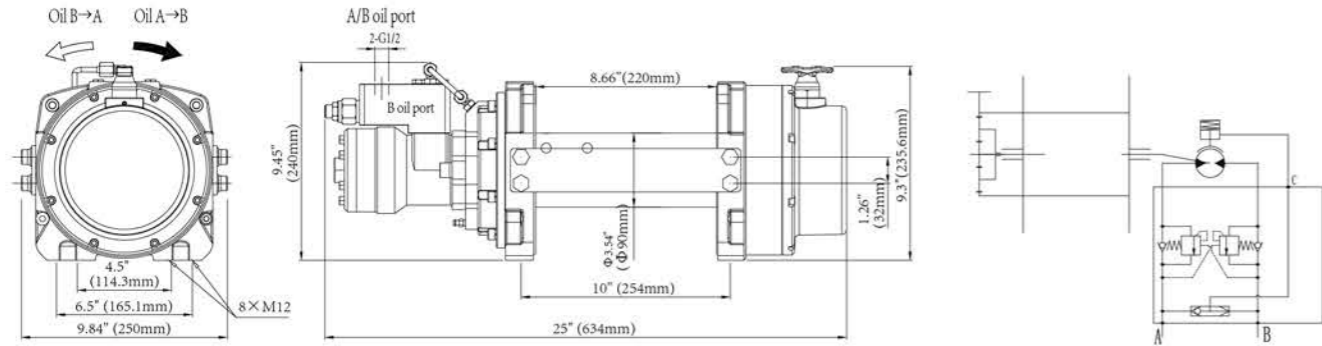

PNEUMATIC CLUTCH	
Air pressure range (bar)	1~8
Ventilation volume (L/min)	1

### SPECIFICATION

Model	First layer line pull		First layer line speed		Working pressure diff.		Oil flow supply	Gear ratio
	lbs	kg	fpm	mpm	psi	MPa	l/min	
HEN8000	8000	3629	27.9	8.5	1885	13	55	16.9:1
HEN10000	10000	4536	21.3	6.5	2030	14	55	16.9:1

Model	Wire rope dia.		Layer	Wire rope capacity	
	inch	mm		ft	m
HEN8000	Φ3/8"	Φ9.2	4	114.8'	35
HEN10000	Φ13/32"	Φ10.3	4	98.4'	30

### PERFORMANCE

Model	Layer of cable	HEN8000					
		Rated line pull per layer		Line speed		Wire rope capacity per layer	
		lbs	kg	fpm	mpm	ft	m
	1	8000	3629	27.9	8.5	18.4'	5.6
	2	6748	3061	33.1	10.1	46.3'	14.1
	3	5835	2647	38.4	11.7	78.4'	23.9
	4	5140	2332	43.3	13.2	114.8'	35

Model	Layer of cable	HEN10000					
		Rated line pull per layer		Line speed		Wire rope capacity per layer	
		lbs	kg	fpm	mpm	ft	m
	1	10000	4536	21.3	6.5	16.1'	4.9
	2	8296	3763	25.6	7.8	41.3'	12.6
	3	7088	3215	30.2	9.2	71.2'	21.7
	4	6188	2807	34.5	10.5	98.4'	30

### NET WEIGHT(WITHOUT WIRE ROPE)

Model	Weight	
	lbs	kg
HEN8000	108	49
HEN10000	110	50

### WARNING:

1. Do not use winch to hoist people or objects over people.
2. Do not use clutch under load.
3. Winch system must include a relief valve.

### NOTE:

1. Recommended oil flow supply range is 35-60 l/min.
2. Independent oil supply system with relief valve is recommended.

# HEN SERIES

## HEN12000-15000

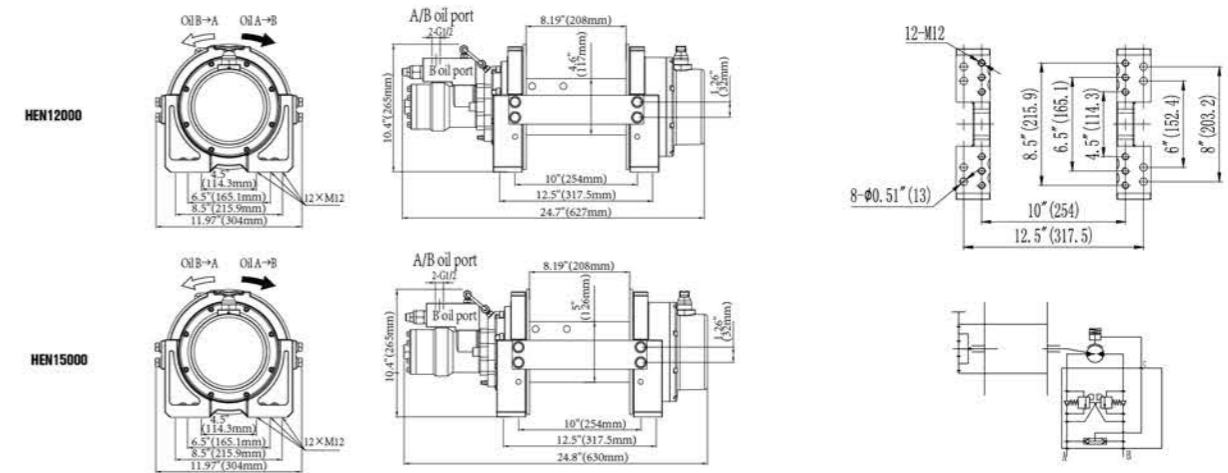

PNEUMATIC CLUTCH	
Air pressure range (bar)	1~8
Ventilation volume (L/min)	1

### SPECIFICATION

Model	First layer line pull		First layer line speed		Working pressure diff.		Oil flow supply	Gear ratio
	lbs	kg	fpm	mpm	psi	MPa	l/min	
HEN12000	12000	5443	21.3	6.5	1885	13	55	17.3:1
HEN15000	15000	6804	19.7	6	2175	15	55	17.3:1

Model	Wire rope dia.		Layer	Wire rope capacity	
	inch	mm		ft	m
HEN12000	Φ15/32"	Φ12	4	98.4'	30
HEN15000	Φ1/2"	Φ13	4	98.4'	30

### PERFORMANCE

Model	Layer of cable	HEN12000					
		Rated line pull per layer		Line speed		Wire rope capacity per layer	
		lbs	kg	fpm	mpm	ft	m
	1	12000	5443	21.3	6.5	16.8'	5.1
	2	10118	4589	25.3	7.7	42.7'	13
	3	8746	3967	29.2	8.9	72.5'	22.1
	4	7701	3493	33.1	10.1	98.4'	30

Model	Layer of cable	HEN15000					
		Rated line pull per layer		Line speed		Wire rope capacity per layer	
		lbs	kg	fpm	mpm	ft	m
	1	15000	6804	19.7	6	16.7'	5.1
	2	12636	5732	23.3	7.1	42'	12.8
	3	10916	4952	27	8.2	71.5'	21.8
	4	9608	4358	30.8	9.4	98.4'	30

### NET WEIGHT(WITHOUT WIRE ROPE)

Model	Weight	
	lbs	kg
HEN12000	139	63
HEN15000	143.3	65

### WARNING:

1. Do not use winch to hoist people or objects over people.
2. Do not use clutch under load.
3. Winch system must include a relief valve.

### NOTE:

1. Recommended oil flow supply range is 35-60 l/min.
2. Independent oil supply system with relief valve is recommended.

# HEN SERIES

# HEN MAX SERIES

## HEN18000

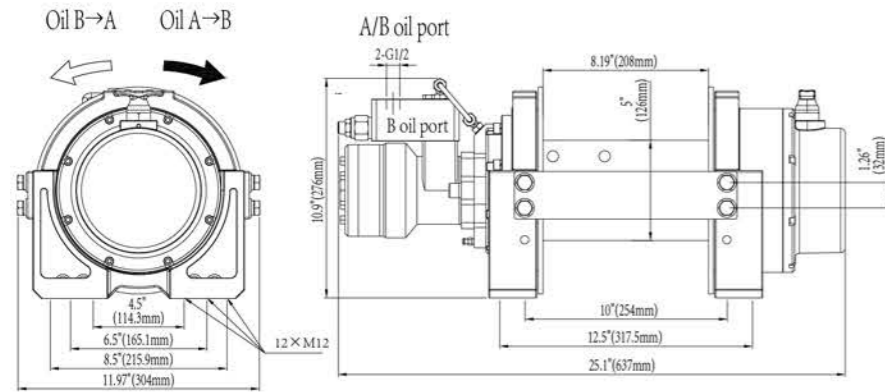

PNEUMATIC CLUTCH	
Air pressure range (bar)	1~8
Ventilation volume (L/min)	1

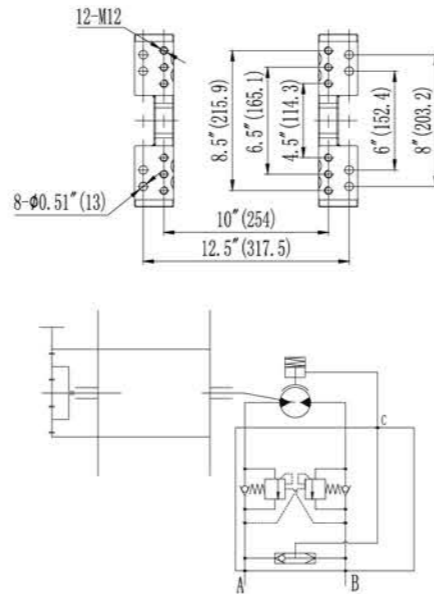

SPECIFICATION								
Model	First layer line pull		First layer line speed		Working pressure diff.		Oil flow supply	Gear ratio
	lbs	kg	fpm	mpm	psi	MPa	l/min	
HEN18000	18000	8165	23	7	2320	16	60	17.3:1

Model	Wire rope dia.		Layer	Wire rope capacity	
	inch	mm		ft	m
HEN18000	φ35/64	φ14	4	98.4'	30

PERFORMANCE							
Model	Layer of cable	HEN18000					
		Rated line pull per layer		Line speed		Wire rope capacity per layer	
		lbs	kg	fpm	mpm	ft	m
	1	18000	8165	23	7	15.1'	4.6
	2	15000	6804	27.5	8.4	39'	11.9
	3	12857	5832	32.1	9.8	66.9'	20.4
	4	11250	5103	36.7	11.2	98.4'	30

NET WEIGHT (WITHOUT WIRE ROPE)		
Model	Weight	
	lbs	kg
HEN18000	154.4	70

**WARNING:**

- Do not use winch to hoist people or objects over people.
- Do not use clutch under load.
- Winch system must include a relief valve.

**NOTE:**

- Recommended oil flow supply range is 35-75 l/min.
- Independent oil supply system with relief valve is recommended.

## 25000lb

### UPGRADED

Stronger G 1/2" threads for oil hose connections and oil-bath gearbox

### SAFE

Amazing multi-discs brake for maximum stopping power

### SUPER-STRONG

Oversized casting steel drum supports, hardened planetary gears and carbon steel tie bar

### RELIABLE

Smart dual balance valve for changing rope direction and tested to 125% rated load

### SEALED

IP67 rated seals keep elements away



### OPTIONAL ACCESSORIES:



SWIVEL SAFETY HOOK



WIRE ROPE ASSEMBLY



HEAVY DUTY ROLLER FAIRLEAD



MANUAL CLUTCH



# HEN MAX SERIES

# HEN MAX SERIES

## HEN25000

PNEUMATIC CLUTCH	
Air pressure range (bar)	1~8
Ventilation volume (L/min)	1

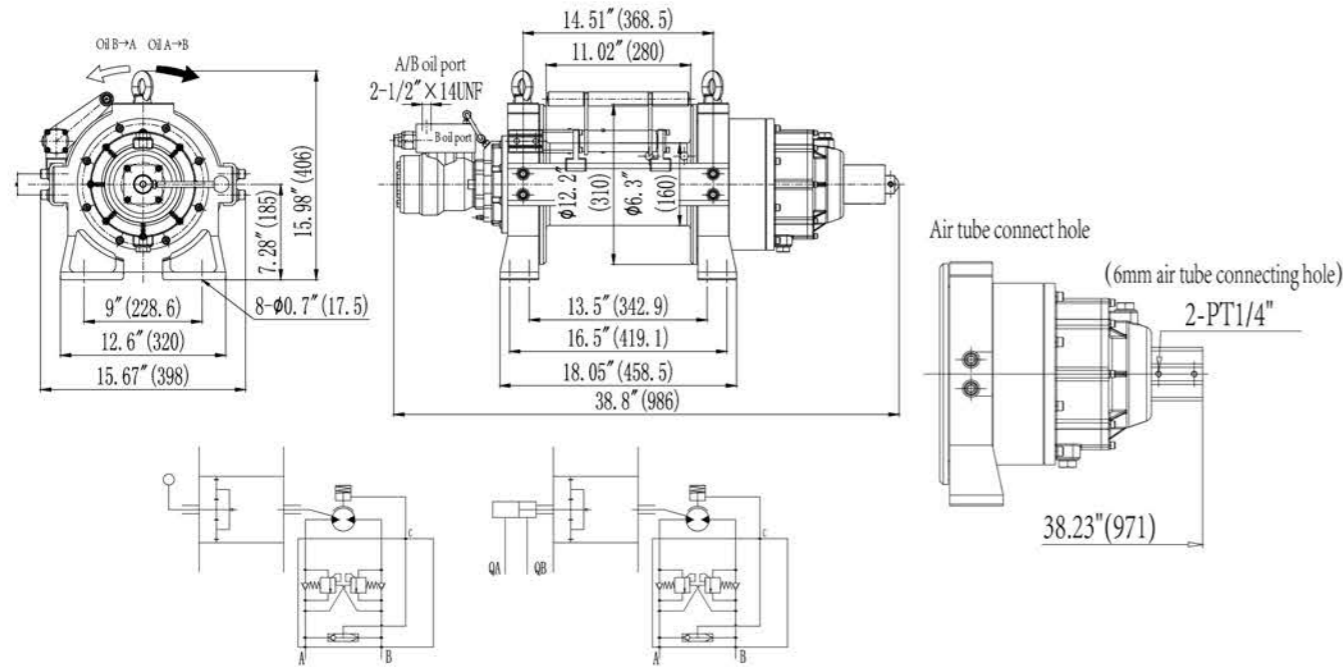

### SPECIFICATION

Model	First layer line pull		First layer line speed		Working pressure diff.		Oil flow supply	Gear ratio
	lbs	kg	fpm	mpm	psi	MPa	l/min	
HEN25000	25000	11340	18	5.5	2465	17	70	20.0:1

Model	Wire rope dia.		Layer	Wire rope capacity	
	inch	mm		ft	m
HEN25000	φ5/8"	φ16	4	131'	40

### PERFORMANCE

Model	HEN25000					
	Rated line pull per layer		Line speed		Wire rope capacity per layer	
Layer of cable	lbs	kg	fpm	mpm	ft	m
1	25000	11340	18	5.5	25'	7.6
2	21153	9595	21.3	6.5	60.4'	18.4
3	18333	8316	24.6	7.5	101'	30.8
4	16176	7337	27.8	8.5	131'	40

### NET WEIGHT(WITHOUT WIRE ROPE)

Model	Weight	
	lbs	kg
HEN25000	359.4	163

### WARNING:

1. Do not use winch to hoist people or objects over people.
2. Do not use clutch under load.
3. Winch system must include a relief valve.

### NOTE:

1. Recommended oil flow supply range is 35-90 l/min.
2. Independent oil supply system with relief valve is recommended.

## 30000-45000lb

### UPGRADED

Stronger G 1/2" threads for oil hose connections and oil-bath gearbox

### SAFE

Amazing multi-discs brake for maximum stopping power

### SUPER-STRONG

Oversized casting steel drum supports, hardened planetary gears and carbon steel tie bar



### RELIABLE

Smart dual balance valve for changing rope direction and tested to 125% rated load

### SEALED

IP67 rated seals keep elements away

### OPTIONAL ACCESSORIES:



SWIVEL SAFETY HOOK



WIRE ROPE ASSEMBLY



HEAVY DUTY ROLLER FAIRLEAD



MANUAL CLUTCH



# HEN MAX SERIES

## HEN30000-35000

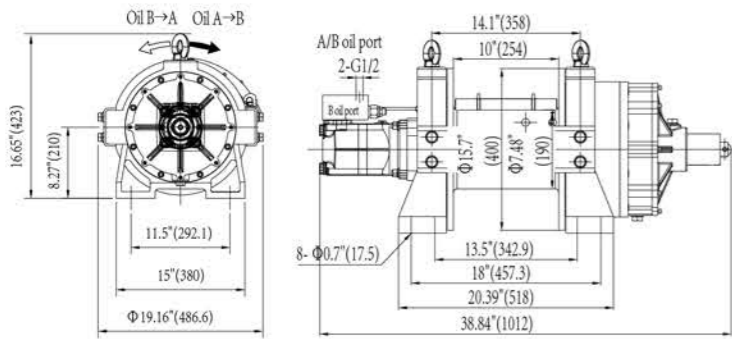

### PNEUMATIC CLUTCH

Air pressure range (bar)	1~8
Ventilation volume (L/min)	1

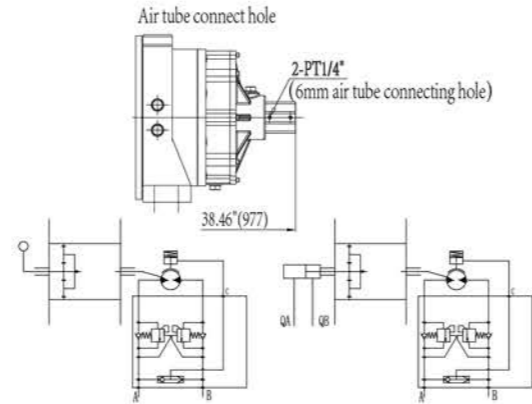

### SPECIFICATION

Model	First layer line pull		First layer line speed		Working pressure diff.		Oil flow supply l/min	Gear ratio
	lbs	kg	fpm	mpm	psi	MPa		
HEN30000	30000	13608	15.1	4.6	2465	17	70	30.39:1
HEN35000	35000	15876	15.1	4.6	2465	17	70	30.39:1

Model	Wire rope dia.		Layer	Wire rope capacity	
	inch	mm		ft	m
HEN30000	Φ3/4"	Φ18	5	170.6'	52
HEN35000	Φ3/4"	Φ18	5	170.6'	52

### PERFORMANCE

Model	Layer of cable	Rated line pull per layer		Line speed		Wire rope capacity per layer	
		lbs	kg	fpm	mpm	ft	m
HEN30000	1	30000	13608	15.1	4.6	22.9'	7
	2	25578	11600	17.4	5.3	52.5'	16
	3	22288	10108	19.7	6.0	91.8'	28
	4	19750	8957	22.0	6.7	134.5'	41
	5	17728	8040	24.3	7.4	170.6'	52
HEN35000	1	35000	15876	15.1	4.6	22.9'	7
	2	29836	13533	17.4	5.3	52.5'	16
	3	26000	11793	20.0	6.1	91.8'	28
	4	23038	10450	22.6	6.9	134.5'	41
	5	20682	9381	25.3	7.7	170.6'	52

### NET WEIGHT(WITHOUT WIRE ROPE)

Model	Weight	
	lbs	kg
HEN30000	573	260
HEN35000	573	260

### WARNING:

1. Do not use winch to hoist people or objects over people.
2. Do not use clutch under load.
3. Winch system must include a relief valve.

### NOTE:

1. Recommended oil flow supply range is 35-90 l/min.
2. Independent oil supply system with relief valve is recommended.

# HEN MAX SERIES

## HEN40000-45000

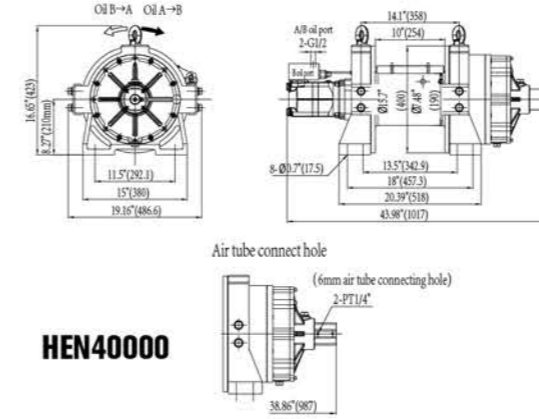

HEN40000

### PNEUMATIC CLUTCH

Air pressure range (bar)	1~8
Ventilation volume (L/min)	1

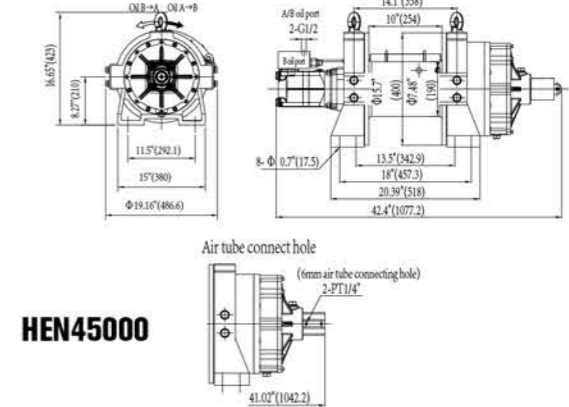

HEN45000

### SPECIFICATION

Model	First layer line pull		First layer line speed		Working pressure diff.		Oil flow supply l/min	Gear ratio
	lbs	kg	fpm	mpm	psi	MPa		
HEN40000	40000	18144	13.8	4.2	2175	15	85	30.4:1
HEN45000	45000	20412	12.5	3.8	2465	17	85	30.4:1

Model	Wire rope dia.		Layer	Wire rope capacity	
	inch	mm		ft	m
HEN40000	Φ4/5"	Φ20	5	147.6'	45
HEN45000	Φ7/8"	Φ22	4	111.5'	34

### PERFORMANCE

Model	Layer of cable	Rated line pull per layer		Line speed		Wire rope capacity per layer	
		lbs	kg	fpm	mpm	ft	m
HEN40000	1	40000	18144	13.8	4.2	25.9'	7.9
	2	33600	15241	16.1	4.9	56.7'	17.3
	3	28966	13139	18.4	5.6	92.5'	28.2
	4	25455	11546	20.7	6.3	133.2'	40.6
	5	22703	10298	23.3	7.1	147.6'	45
HEN45000	1	45000	20412	12.5	3.8	25.23'	7.6
	2	37266	16903	14.8	4.5	53.05'	16.2
	3	31800	14424	17.1	5.2	82.57'	25.2
	4	27733	12579	19.4	5.9	111.5'	34

### NET WEIGHT(WITHOUT WIRE ROPE)

Model	Weight	
	lbs	kg
HEN40000	584	265
HEN45000	595	270

### WARNING:

1. Do not use winch to hoist people or objects over people.
2. Do not use clutch under load.
3. Winch system must include a relief valve.

### NOTE:

1. Recommended oil flow supply range is 40-90 l/min.
2. Independent oil supply system with relief valve is recommended.

## HEN45000L

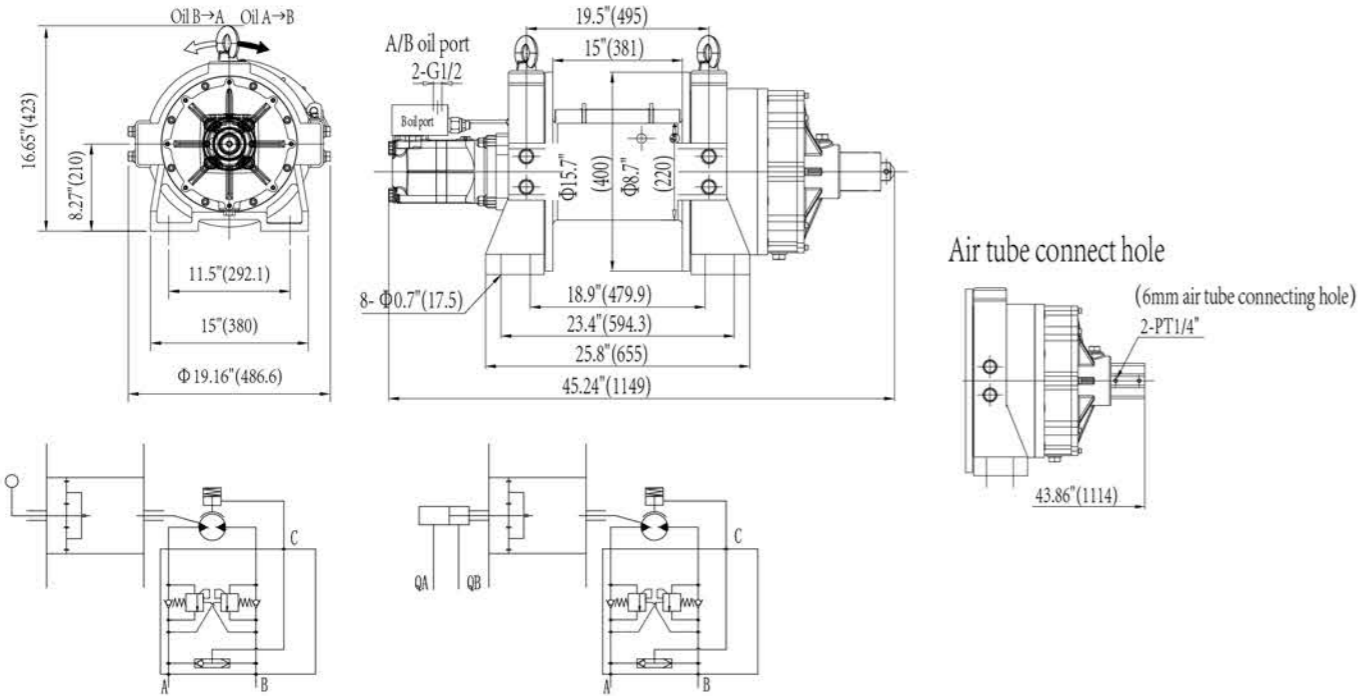

PNEUMATIC CLUTCH	
Air pressure range (bar)	1~8
Ventilation volume (L/min)	1

SPECIFICATION								
Model	First layer line pull		First layer line speed		Working pressure diff.		Oil flow supply	Gear ratio
	lbs	kg	fpm	mpm	psi	MPa	l/min	
HEN45000L	45000	20412	12.5	3.8	2465	17	85	30.4:1

Model	Wire rope dia.		Layer	Wire rope capacity	
	inch	mm		ft	m
HEN45000L	φ7/8"	φ22	4	190.3'	58

PERFORMANCE							
Model	HEN45000L						
	Layer of cable	Rated line pull per layer		Line speed		Wire rope capacity per layer	
		lbs	kg	fpm	mpm	ft	m
1	45000	20412	12.5	3.8	37'	11.3	
2	38571	17496	14.8	4.5	82'	25	
3	33750	15309	17.1	5.2	134'	41	
4	30000	13608	19.4	5.9	190.3'	58	

NET WEIGHT(WITHOUT WIRE ROPE)		
Model	Weight	
	lbs	kg
HEN45000L	650.5	295

- WARNING:**
1. Do not use winch to hoist people or objects over people.
  2. Do not use clutch under load.
  3. Winch system must include a relief valve.

- NOTE:**
1. Recommended oil flow supply range is 40-90 l/min.
  2. Independent oil supply system with relief valve is recommended.



## K SERIES WINCH

The NOVAWINCH K Series merges performance with affordability. 3,000-2,000 lbs capacities.

## PORTABLE TOOL

The NOVAWINCH PT1100 brings real winching power to, well, everywhere. The fully portable PT1100 is available with an onboard lithium ion battery or can be plugged into AC wall outlets making this the most portable winch out there.



## QD SERIES TRAILER WINCH

Built for simple operation the QD Series from NOVAWINCH is perfect for trailers. Protective cover keeps the winch safe from elements while the robust gearing keeps pulling well after the others have quit.



## NVYC SERIES

Move trailers easily - even up inclines. This electric trailer buddy powers forward and reverse plus the Mini Mover features adjustable height control.

Moves up to 6,000lbs of rolling weight and 1100lbs dead weight.



### Roller fairlead | ACFL001



Part No.	Compatible Winch	Specification
ACFL001-1	NVK2000-3000	Mounting distance 109mm
ACFL001-2	NVT2500-3500	Mounting distance 124mm
ACFL001-3	FENIX2500-3500	Mounting distance 124mm
ACFL001-4	NVT4500	Mounting distance 152mm
ACFL001-5	FENIX4500	Mounting distance 152mm
ACFL001-6	NVT8000-12000	Mounting distance 254mm
ACFL001-7	NVT12500-18000/HEN8000-18000	Mounting distance 254mm
ACFL001-8	PRO9500-18500	Mounting distance 254mm
ACFL001-9	HEN20000-25000	Mounting distance 368.5mm
ACFL001-10	HEN30000-45000	Mounting distance 358mm
ACFL001-11	HEN45000L	Mounting distance 495mm

### Hawse Fairlead | ACHF002



Part No.	Compatible Winch	Specification
ACHF002-1	NVT2500-3500/FENIX2500-3500	Mounting distance 124mm
ACHF002-2	NVT4500/ FENIX4500	Mounting distance 152mm
ACHF002-3	PRO9500-18500/ NVT8000-18000	Mounting distance 254mm

### Remote Control | ACRS003



Part No.	Compatible Winch	Specification
ACRS003-1	NVT2500-4500/FENIX2500-4500	Handheld remote, cord length 9.85'(3m)
ACRS003-2	NVT2500-4500/FENIX2500-4500	Mini-rocker handlebar remote, cord length 9.85'(3m)
ACRS003-3	NVT8000-18000/EN2500-6100	Handheld remote, cord length 12.7'(3.9m)
ACRS003-4	NVK2000-3000	Handheld remote, cord length 5.9'(1.8m) and 4.27'(1.3m)
ACRS003-5	PRO9500-12500	Handheld rubber remote, cord length 12.7'(3.9m)
ACRS003-6	PRO14500-18500	Handheld rubber remote, metal plug, cord length 3.9m
ACRS003-7	NVQD3000	Handheld remote, metal plug, cord length 3.9m

### Wireless Remote Control | ACWRS004



Part No.	Compatible Winch	Specification
ACWRS004-1	All electric winches include DC12V and DC24V	Universal wireless remote, operate winch remotely 65'(20m)
ACWRS004-2	All electric winches DC12V	New Design! IP68 universal wireless remote, operate winch remotely 65'(20m)

## High Strength Synthetic Rope For Electric Winch | ACSY005



Part No.	Compatible Winch	Specification
ACSY005-1	NVT2500-3500	4.8mm x 15m
ACSY005-2	FENIX2500-3500	4.9mm x 15.25m Dyneema
ACSY005-3	NVT4500	6mm x 15m
ACSY005-4	FENIX4500	6.3mm x 15.25m Dyneema
ACSY005-5	NVT8000	8.1mm x 29m
ACSY005-6	PRO9500/ NVT10000-12000	9.2mm x 26m
ACSY005-7	PRO12500	9.5mm x 26m
ACSY005-8	PRO14500-16500/ NVT15000	12mm x 28m
ACSY005-9	PRO18500/ NVT18000	13mm x 25m

## Anti-rust Galvanized Steel Rope For Electric Winch | ACST006



Part No.	Compatible Winch	Specification
ACST006-1	NVK2000	4mm x 15m
ACST006-2	NVT2500/NVK3000	4.8mm x 14m
ACST006-3	FENIX2500	4.8mm x 15.2m
ACST006-4	NVT3500	5.0mm x 13.7m
ACST006-5	FENIX3500	5.4mm x 15.2m
ACST006-6	NVT4500	5.4mm x 17m
ACST006-7	NVQD3000	5.4mm x 15.2m with hook
ACST006-8	FENIX4500	6.0mm x 17m
ACST006-9	EN2500	7.2mm x 20m
ACST006-10	EN3600	8.1mm x 20m
ACST006-11	NVT8000	8.1mm x 29m
ACST006-12	PRO9500-12500/NVT10000-12000/EN4300	9.2mm x 26m
ACST006-13	NVT12500	10.3mm x 29m
ACST006-14	PRO14500/NVT15000	11.5mm x 28m
ACST006-15	PRO16500	12mm x 28m
ACST006-16	PRO18500/NVT18000	13mm x 25m

## Anti-rust Galvanized Steel Rope For Hydraulic Winch | ACST007



Part No.	Compatible Winch	Specification
ACST007-1	HEN8000	9.2mm x 35m
ACST007-2	HEN10000	10.3mm x 30m
ACST007-3	HEN12000	12mm x 30m
ACST007-4	HEN15000	13mm x 30m
ACST007-5	HEN18000	14mm x 30m

## Anti-rust Black Oil Steel Rope For Hydraulic Winch | ACST008



Part No.	Compatible Winch	Specification
ACST008-1	HEN20000-22000	14mm x 48m
ACST008-2	HEN25000	16mm x 40m
ACST008-3	HEN30000-35000	18mm x 52m
ACST008-4	HEN40000	20mm x 45m
ACST008-5	HEN45000	22mm x 34m
ACST008-6	HEN45000L	22mm x 58m

## Quick connector | ACQC009



Part No.	Compatible Winch	Specification
ACQC009-1	FENIX2500-4500/NVT2500-4500 NVK2000-3000	2 pcs connector as 1 set, 50A standard
ACQC009-2	PRO9500-18500/NVT8000-18000 EN2500-6100	2 pcs connector as 1 set, 175A standard

## Contactor | ACCT010



Part No.	Compatible Winch	Specification
ACCT010-1	NVT2500-4500	250A
ACCT010-2	FENIX2500-4500	250A
ACCT010-3	PRO9500-18500/NVT8000-18000/EN2500-6100	500A

## Pulley Block | ACPB011



Part No.	Compatible Winch	Specification
ACPB011-1	Corresponding to the winch pulling	2000LB
ACPB011-2	Corresponding to the winch pulling	8000LB
ACPB011-3	Corresponding to the winch pulling	10000LB
ACPB011-4	Corresponding to the winch pulling	20000LB
ACPB011-5	Corresponding to the winch pulling	30000LB

## Clevis Hook | ACCH012



Part No.	Compatible Winch	Specification
ACCH012-1	FENIX2500-4500/NVT2500-4500/NVK2000-3000/TH1000-1000SD/CH500	1/4"
ACCH012-2	NVT8000	5/16"
ACCH012-3	PRO9500-12500/NVT8000-15000/EN2500-4300/HEN8000-10000	3/8"
ACCH012-4	PRO14500-18500/NVT18000/HEN12000-18000	1/2"

## Shackle | ACSV013



Part No.	Compatible Winch	Specification
ACSK013-1	Corresponding the winch pulling	1.4T D-shackle
ACSK013-2	Corresponding the winch pulling	2.0T Bow shackle
ACSK013-3	Corresponding the winch pulling	3.25T D-shackle
ACSK013-4	Corresponding the winch pulling	4.75T D-shackle
ACSK013-5	Corresponding the winch pulling	3.25T Bow shackle
ACSK013-6	Corresponding the winch pulling	4.75T Bow shackle
ACSK013-7	Corresponding the winch pulling	7/16"X20" Synthetic Soft Shackle

# ACCESSORIES

## Mounting Plate | ACMP014



Part No.	Compatible Winch	Specification
ACMP014-1	PRO9500-12500/ NVT12500-18000/ EN3600-4300/HEN8000-10000	675x255x104mm
ACMP014-2	PRO14500-18500/ EN6100 /HEN12000-18000	690x310x117mm
ACMP014-3	NVT8000-12000/EN2500	400x195x210mm

## Tree Trunk Protector | ACTP015



Part No.	Compatible Winch	Specification
ACTP015-1	25.4mm (W.) x 2.44m (L.)	4500lb
ACTP015-2	50.8mm (W.) x 2.4m (L.)	8800lb
ACTP015-3	76.2mm (W.) x 3m (L.)	19800lb

## Winch covers | ACCO016



Part No.	Compatible Winch	Specification
ACCO016-1	FENIX2500-4500/NVT2500-4500/NVK2000-3000	40x12x17cm
ACCO016-2	NVT8000-12000/PRO9500-12500/EN2500	57x16x27cm
ACCO016-3	PRO14500-18500/NVT12500-18000/EN3600-6100	64x22x29cm

## Winch Accessory Kit | ACWA017



Part No.	Compatible Winch	Specification
ACWA017-1	Winch Accessory Kit For ATV	<ul style="list-style-type: none"> <li>- KIT INCLUDE</li> <li>- PB8000 Snatch Block · 3.25T Bow Shackle (2x)</li> <li>- 25.4mm W.x 2.44m L. Tree Trunk Protector (2x)</li> <li>- Winch Gloves · Winch Rope Damper</li> <li>- Winch Accessory Bag</li> </ul>
ACWA017-2	Winch Accessory Kit for OFF ROAD	<ul style="list-style-type: none"> <li>- KIT INCLUDE</li> <li>- PB10000 Snatch Block · 4.75T Bow Shackle (2x)</li> <li>- 76.2mm W.x 3m L. Tree Trunk Protector (1x)</li> <li>- Winch Gloves · Winch Rope Damper</li> <li>- Winch Accessory Bag</li> </ul>

## Rope Damper | ACRD018



Part No.	Compatible Winch	Specification
ACRD018-1	All winches	90 x 50cm

## Receiver Bracket & Shackle | ACRB019



Part No.	Compatible Winch	Specification
ACRB019-1	All winches	305 x 130 x 50.8mm



# TRUSTED AROUND THE WORLD.

As a global leader in winch design, engineering and manufacturing, NOVWINCH is proud to be supported by hand-picked local experts around the world. These professionals are ready to not only outfit for your pulling needs, but to offer the best in service to keep your winching gear in top shape.

If you can't find a NOVWINCH expert in your area, we welcome your contact to discuss distribution or agent opportunities - [info@novawinch.com](mailto:info@novawinch.com)

**NOVWINCH**®