



23/13-98

Canon SUPER 8 AUTO ZOOM 518 SV

INSTRUCTIONS

English Edition

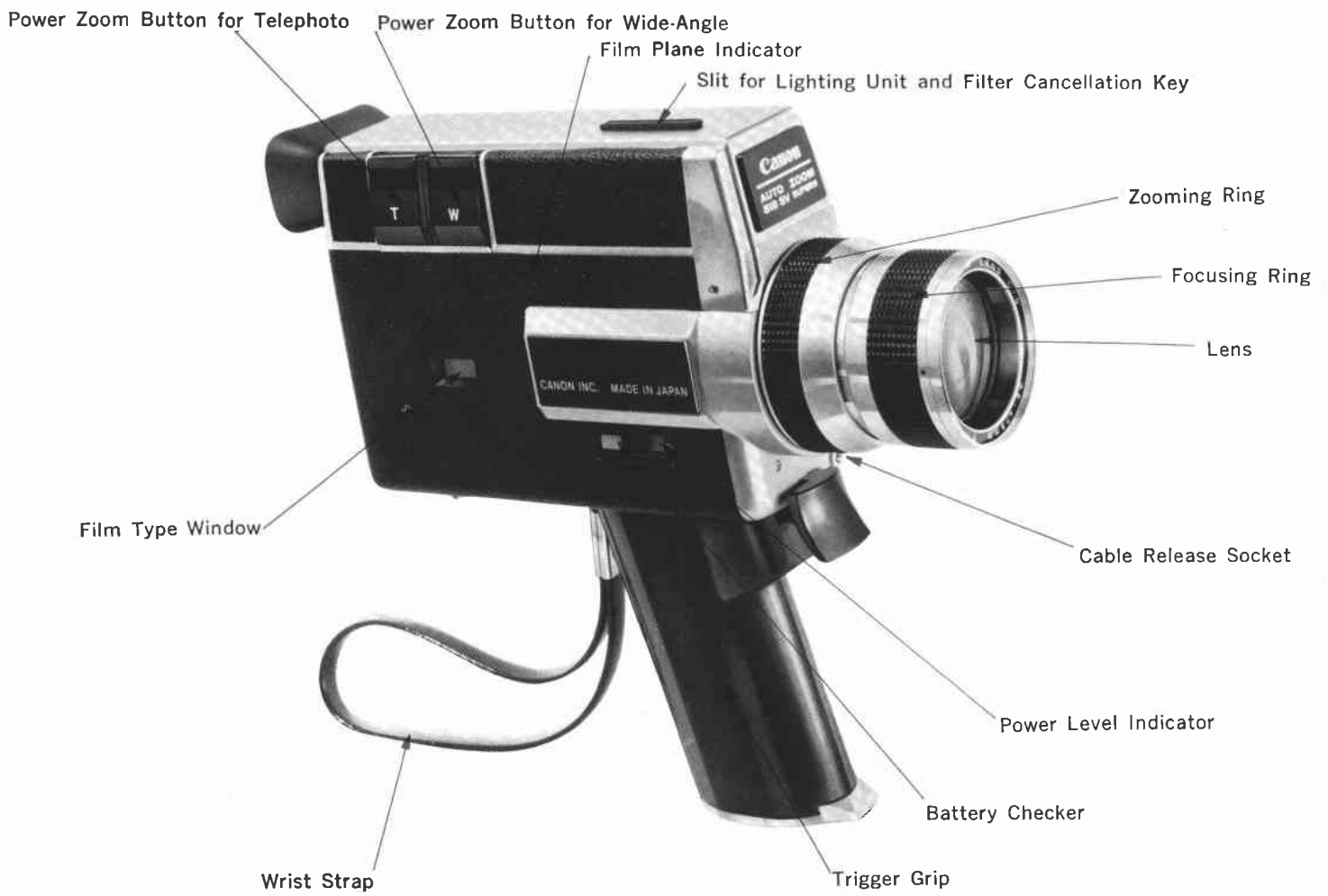





After you have loaded the batteries and adjusted the eyepiece, follow these simple steps:

1 Insert a Super 8 film cartridge.

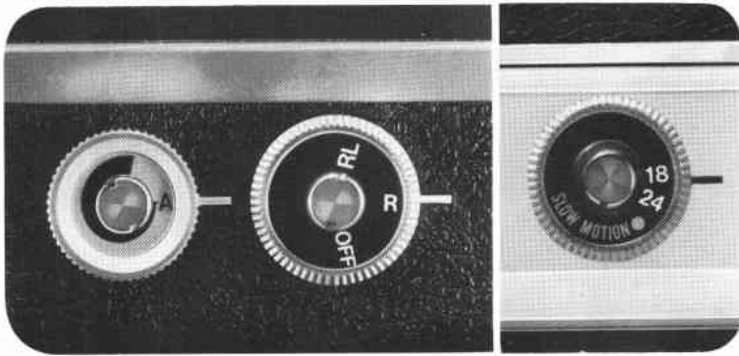

2 Turn the shutter lock dial to "R".
Set the aperture control ring at "A".
Set the filming speed dial at "18".



3 Look through the viewfinder and focus in telephoto.



4 Pull the trigger slightly and check whether the exposure indicator is within the proper range.
4 Decide the composition of the picture by turning the zoom lens.



5 Pull the trigger.
5 Zoom in and zoom out according to your needs.

	page
Manual Aperture Control	14
Fadings.....	14
Filters.....	15
Close-Up Lenses	15
Converters	16
Shooting with Artificial Light	17
Unloading of Film Cartridge	17
Proper Care of the Camera	18

Your Camera Body Number _____
Date of Purchase _____
Dealer's Name _____

AUTO ZOOM 518 SV



Main Features of Your Super 8 Camera

- 1** Uses Super 8 film cartridge—50% larger picture area.
- 2** Simple cartridge loading with automatic film speed setting.
- 3** Sharp and fast F1.8 5-times zoom lens with zooming range of 9.5–47.5mm. Extendible to 6.2–31mm with Wide-Converter or 15.6–78mm with Tele-Converter.
- 4** Automatic through-the-lens exposure control using CdS photo-cell with servo EE meter.
- 5** Single-lens reflex viewing and microprism screen rangefinder for accurate focusing.
- 6** Powered film drive and zooming.
- 7** Manually operable aperture for fade-ins and fade-outs.
- 8** 18 fps normal filming speed, 24 fps, and "SLOW MOTION".
- 9** Easy-to-hold trigger grip.



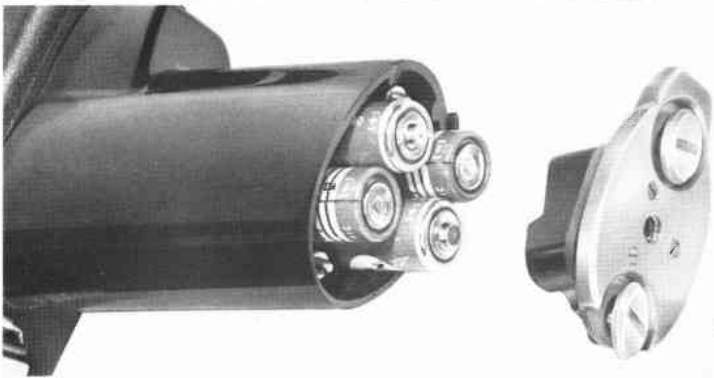
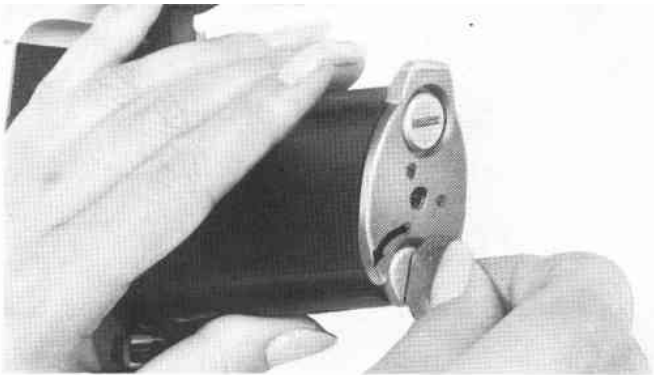

Loading of Batteries

Load four 1.5 v penlight (size AA) batteries for film drive, power zoom, and electric eye. The power system functions only when the batteries are properly inserted.

- 1 Remove the battery chamber cover by turning the two tightening knobs counterclockwise and insert four penlight batteries, according to the diagram inside the chamber.
- 2 Replace the cover back on. When not using the camera, keep the shutter lock dial at "OFF".

Adjusting Eyepiece

Adjust the eyepiece by turning eyepiece adjustment ring.

- 1 Aim the camera in the direction of bright subject and then look into the viewfinder.
- 2 Turn the eyepiece adjustment ring and adjust it so that the round edge of the rangefinder and the f/stop scale can be clearly seen.
- 3 The eyepiece is now adjusted to your eyesight.

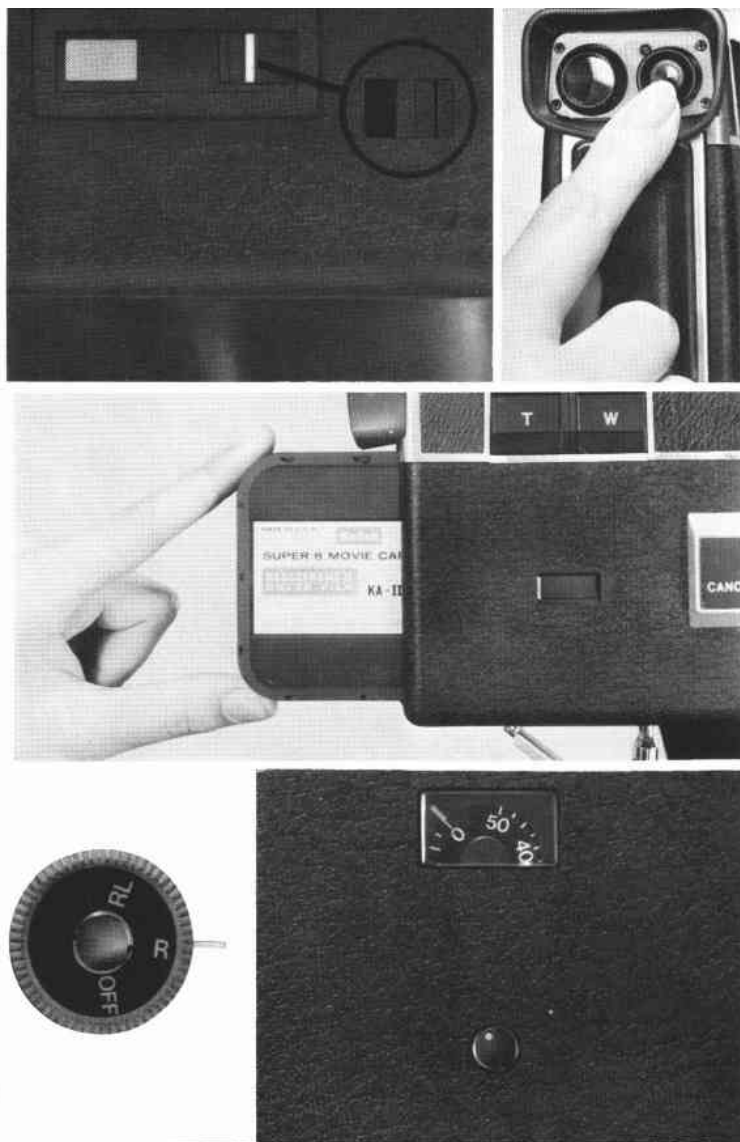

Checking the Power Level of Batteries

The power level of the batteries can be checked by turning the shutter lock dial to "R", pressing the battery checker and checking the position in the power level indicator.

If the needle reaches the blue zone, the batteries have sufficient power level.

If the needle is in the white zone, the batteries have a power level only for 24 fps or under.

If the needle is in the red zone, replace all of the batteries.

■ When not using the camera, keep the shutter lock dial at "OFF".

■ Always check the power level of the batteries before shooting.

■ The film cartridge with following speeds can be used.

Tungsten type : ASA 25, 40, 64, 100, 160, 250, 400

Daylight type : ASA 16, 25, 40, 64, 100, 160, 250

Loading of Film Cartridge

- 1 Open the rear cover by pressing the rear cover lock button.
- 2 Slide the Super 8 film cartridge towards the front of the camera with the film gate facing ahead. The film speed is automatically set with the insertion of the cartridge.
- 3 Close the rear cover by pressing it.
- 4 Set the shutter lock dial at "R". Pull the trigger to confirm the film advance. If you can hear the sound of film winding and the white dot in the film transport indicator revolves, it means the cartridge is properly inserted.
 - The Super 8 film cartridge is loaded with 50-foot film. There is no need for flipping over the cartridge in reverse direction halfway through the film.

Footage Counter

The footage counter tells you how many feet of film you have exposed. It automatically resets to "0" when the cartridge is taken out.

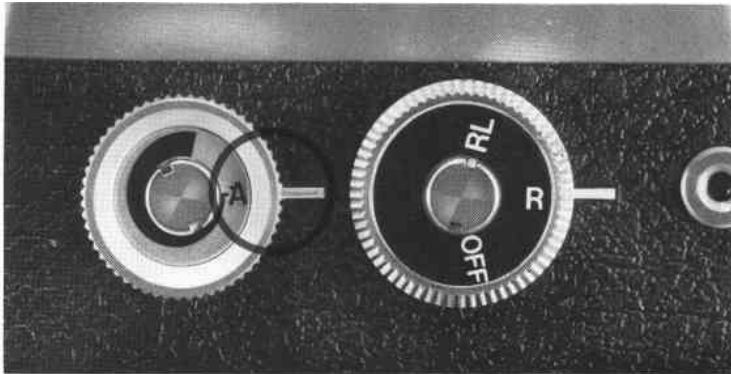

Setting of the Aperture Control Ring

For EE operation, set the aperture control ring at "A".

- The electric eye will function only when the ring is set at the click-stop position of "A".
- Refer to page 14 for other uses of the aperture control ring.

Setting of the Filming Speed Dial

- 1 Set the filming speed dial at "18" for shooting at the normal speed for 18 fps.
- 2 Set the dial at "SLOW MOTION" for shooting at a high speed of approximately 36 fps.
- 3 Set the dial at "24" for shooting standard sound film.

■ "SLOW MOTION" and "24" are very effective when slowing down fast moving subjects and analyzing movements or preventing blurs during panning.

■ Be sure to shift the filming speed dial when not pulling the trigger.

■ Be sure to set the filming speed dial at its click-stop positions.

Holding the Camera

Hold the trigger grip with the right hand and place the forefinger on the trigger. Focusing, zooming and manual aperture control are performed with the left hand.

■ The camera should be held steadily, especially when shooting in telephoto or when zooming. It is advisable that the right elbow is firmly pressed against the body. For best results, use a tripod and cable release whenever possible.

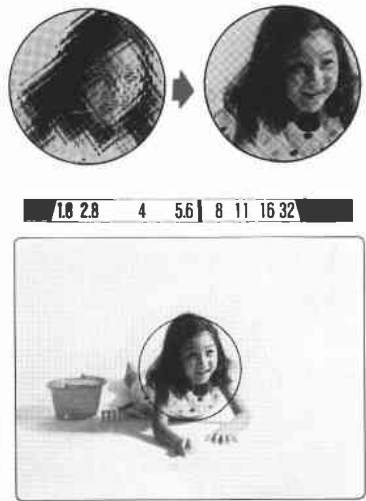
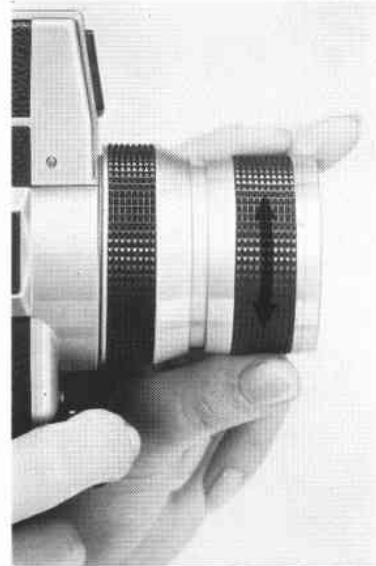
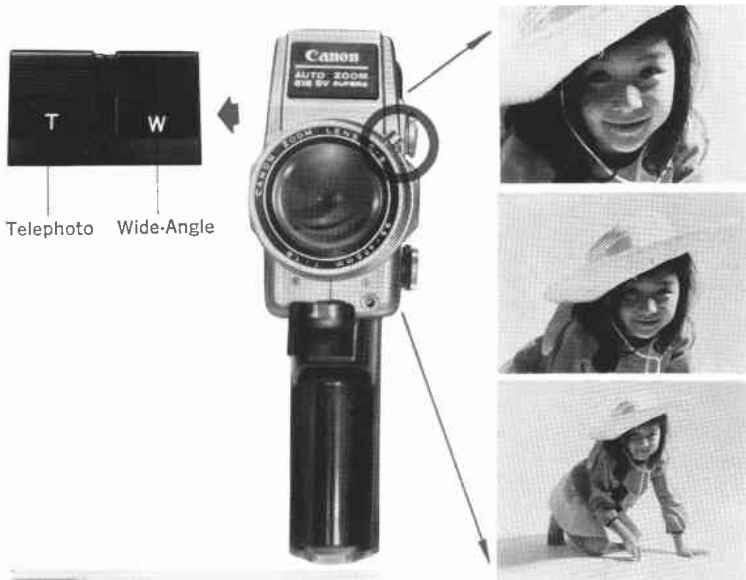

Since the viewfinder of Auto Zoom 518 SV is of the single-lens reflex type, the exact picture image to be filmed can be seen without any parallax. This enables you to compose the scene within the maximum field-of-view.

Focusing

Adjust the focus by turning the focusing ring so that the subject can be seen most clearly through the microprism screen range-finder built into the center of the viewfinder.

The aligned image can be seen more accurately and easily the longer the focal length of the lens. Therefore, first focus at maximum magnification (telephoto) and then return to the desired magnification. The focal point does not change by zooming.

Zooming

When you wish to zoom or want to decide the size of the subject in the picture area, turn the zoom lens by pressing the power zoom buttons or using the manual zoom knob. The image seen through the viewfinder will change in magnification and the field-of-view will also change.

When zooming is performed during shooting, any desired zooming effect can be reproduced on the film.

Power Zooming

Press the power zoom buttons for smooth and regulated zoom effects. Zooming towards telephoto is obtained by pressing the "T" button and towards wide-angle by pressing the "W" button. The necessary zooming time for the entire range is approximately six seconds.

Manual Zooming

When you wish to zoom faster or slower than any regular speed, turn the zoom lens by using the manual zoom knob.

- The viewfinder magnification is in life-size when the focal length is at 14mm.

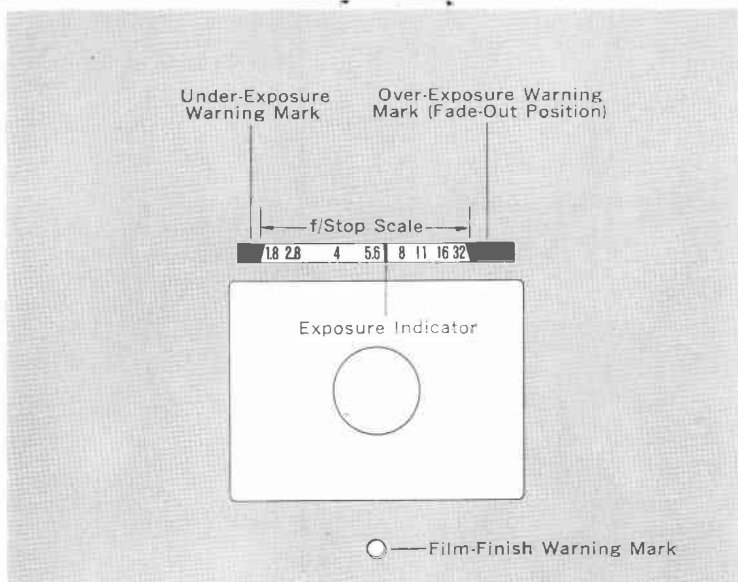

Checking the Exposure Indicator

Aim the camera at the subject, slightly pull the trigger, and check the position of the exposure indicator inside the viewfinder. The electric eye starts operating and the exposure indicator indicates the proper f/stop.

- 1 If the exposure indicator is pointing inside the range of the f/stop scale, you may pull the trigger all the way and the film will advance.
- 2 If the exposure indicator is pointing to the red mark on the left side it means under-exposure, and so the lighting must be increased.
- 3 If the exposure indicator is pointing to the red mark on the right side, the "F.O." position, it means aperture is completely closed for excessive light volume, and so an ND (neutral density) filter must be attached to restrict the light intensity.
 - Make sure that the shutter lock dial is set at "R". Otherwise, the exposure indicator will not move.

Shooting

- 1 Set the shutter lock dial at "R".
- 2 Pull the trigger. The shutter will function and the film will advance.

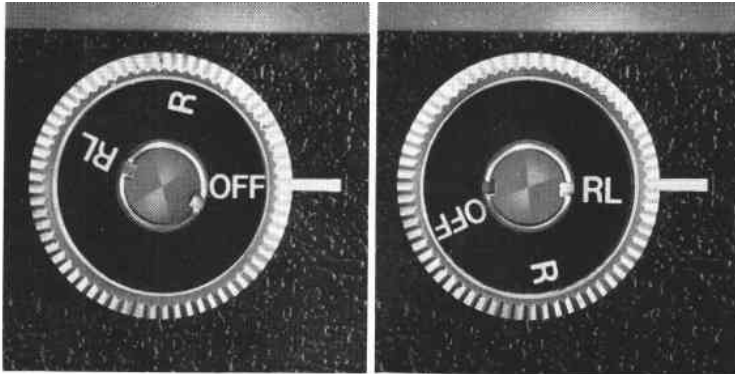

Shutter Lock Dial

- 1 Safety Lock :** When the shutter lock dial is set at "OFF" the shutter release is locked and the power circuit is disconnected.
- 2 Running Lock :** Set the shutter lock dial at "RL", pull the trigger, and the camera will start running. You can release your forefinger from the trigger and the camera will continue running until the dial is returned to "R" position.



Cable Release Socket

You can use the cable release socket for continuous running, close-up work, tilting or when the camera is set on a tripod.

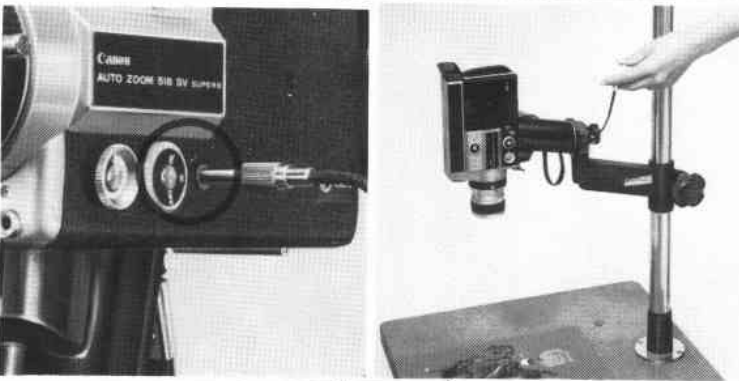

Single Frame Release

Single frame photography is applied to shoot animation and faked pictures, and to record the growth of plants. It is performed by inserting the cable release into the single frame release socket.

- 1** Attach the camera on the tripod, set the shutter lock dial at "R", and set the filming speed dial at "18".
- 2** Pull the trigger slightly and read off the proper f/stop shown by the exposure indicator.
- 3** Set the f/stop manually by pulling up the aperture control ring and turning it counterclockwise.
- 4** Depress the cable release to expose one frame at a time, and then release your finger from the cable release immediately.

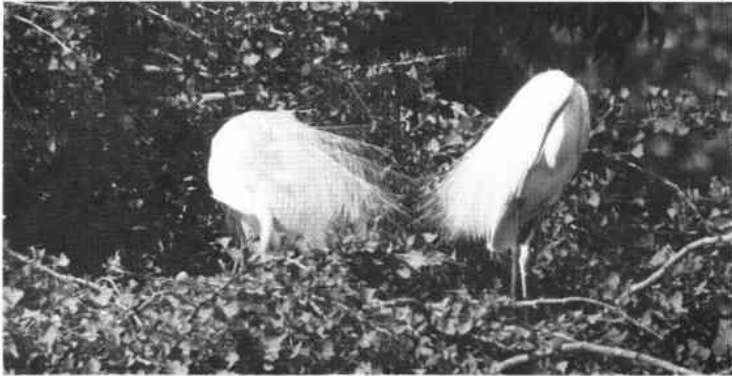

Remote Control

With the use of an optional Remote Switch 3 you can operate the camera from a distance.

- 1 Set the shutter lock dial at "OFF" and insert the remote switch cord into the remote control switch socket of the camera.
- 2 Turn the shutter lock dial to "RL" and pull the trigger.
- 3 Push the knob on the Remote Switch 3 in the direction of the arrow. The camera will start running until the knob on the Remote Switch 3 is returned to its former position.
 - When disconnecting the cord of the Remote Switch 3 from the camera, be sure to return the shutter lock dial to "R" first. Otherwise, the film will start advancing.
 - When not using the remote control, be sure to keep the shutter lock dial at "OFF".
 - The length of the cord for the Remote Switch 3 is 8 meters (26 feet).
 - When shooting with the Remote Switch 3, first ascertain the position of the subject and then cover the eyepiece to prevent reverse incoming light.

Panning

Panning is employed when shooting a scene from one position to another by moving the camera around horizontally to make a continuous shot over a wide area in one sequence.

- Do not move the camera too rapidly in any direction, particularly vertically. Use of a tripod is recommended.
- Panning shots are usually started from subjects of less importance and move on to the most important subject where it ends by running the film longer on the last sequence.
- Move the camera at a constant speed.
- Prevent a subject from being blurred by using high filming speeds, i.e., "24" and "SLOW MOTION".

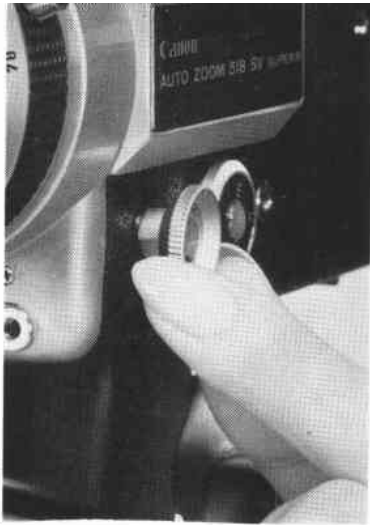

Manual Aperture Control

The aperture can be manually controlled by pulling up the aperture control ring and turning it counterclockwise. In manual operation, any desired f /stop can be set by turning the ring while looking at the f /stop scale inside the viewfinder. Use this method when shooting against the light or when you wish to stress high-key or low-key effects.

- Open one f /stop further when you shift the filming speed dial from "18" to "SLOW MOTION".

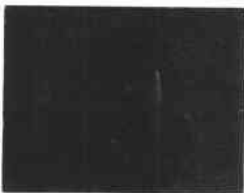

Fade-In



Fade-Out



Fadings

Fadings are used to show the elapse of time or a change in scene, for instance, when the scene on the stage changes at the end of a theme.

You can perform fade-ins and fade-outs by turning the aperture control ring. Use a tripod when you perform fadings.

1 Confirm the proper f /stop by aiming the camera at the subject and pulling the trigger slightly with the aperture control ring set at "A".

2 While shooting, turn the aperture control ring gradually from the fade-out position to the proper f /stop position in the case of fade-in, and from the proper f /stop position to the fade-out position in the case of fade-out.

■ Fadings can be performed smoothly and effectively by attaching an ND (neutral density) filter over the lens and making a larger difference between the proper f /stop and the aperture being totally closed. The use of an ND filter is especially recommended under very bright conditions or under excessive light.

■ Fading times of 1-1.5 seconds for a fast changing scene, and 2-3 seconds for a slower changing scene are advisable.

Type	Filter Characteristics
○●UV	Absorbs only ultra-violet rays. Especially effective at seaside and high mountains. Recommended for use in color photography.
○ Y 1 Y 3	Increases contrast of monochrome film. Enhances clouds, darkening the blue sky. Brightens red and yellow.
○ O 1	Darkens blue, increases yellow and red perceptibly. Good for contrasts, especially in distant landscapes.
○ R 1	Makes strong contrasts. May also be used with infrared film.
○ G 1	Prevents red from turning radically into white. Lightens faces and sky appropriately, and reflects the lightness of fresh greenery.
○●ND 4 ND 8	ND 4 reduces light volume by 1/4, ND 8 by 1/8. No effects on the reproduction of colors of color film.
● SKYLIGHT	Harmonizes the blue sky and shade.
● CCA 4	For use with daylight type film under the cloud.
● CCA 8	For use with tungsten type film under the morning sun or sunset.
● CCB 4	For use with daylight type film under the morning sun or sunset.
● CCB (12 equiv.)	For use with daylight type film under tungsten light.

○ For black and white film. ● For color film.

Type	Focal Length of Zoom Lens	Distance Scale of Focusing Ring	Distance from Film Plane to Subject	Field-of-View
48mm Close-Up Lens 450 C-8	9.5mm	∞	580mm (1'10-13/16")	259x192mm (10-3/16"x7-9/16")
		1.2m (4')	450mm (1'5-7/8")	173x129mm (6-7/8"x5-1/16")
	47.5mm	∞	580mm (1'10-13/16")	52x38mm (2-1/16"x1-1/2")
		1.2m (4')	450mm (1'5-7/8")	35x26mm (1-3/8"x1")
48mm Close-Up Lens 240 C-8	9.5mm	∞	370mm (1'2-9/16")	139x103mm (5-7/16"x4-1/16")
		1.2m (4')	330mm (1'1")	108x80mm (4-1/4"x3-1/8")
	47.5mm	∞	370mm (1'2-9/16")	28x21mm (1-1/16"x13/16")
		1.2m (4')	330mm (1'1")	22x16mm (7/8"x5/8")

Filters

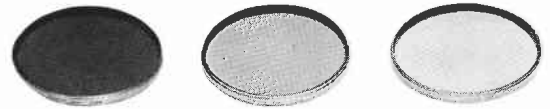

48mm screw-in type filters for Canon Auto Zoom 518 SV and 72mm screw-in type filters for the Converters are available. Since Canon Auto Zoom 518 SV is incorporated with a through-the-lens exposure measuring system, any type of filter can be attached without regard to the exposure factor.

Close-Up Lenses



The 48mm Close-Up Lenses 450 and 240 C-8 are used when titling, close-up work, and when shooting plants and insects. 450 and 240 indicate the distances in millimeters from the tip of the lenses to the subject when the distance scales of the close-up lenses are set at infinity.

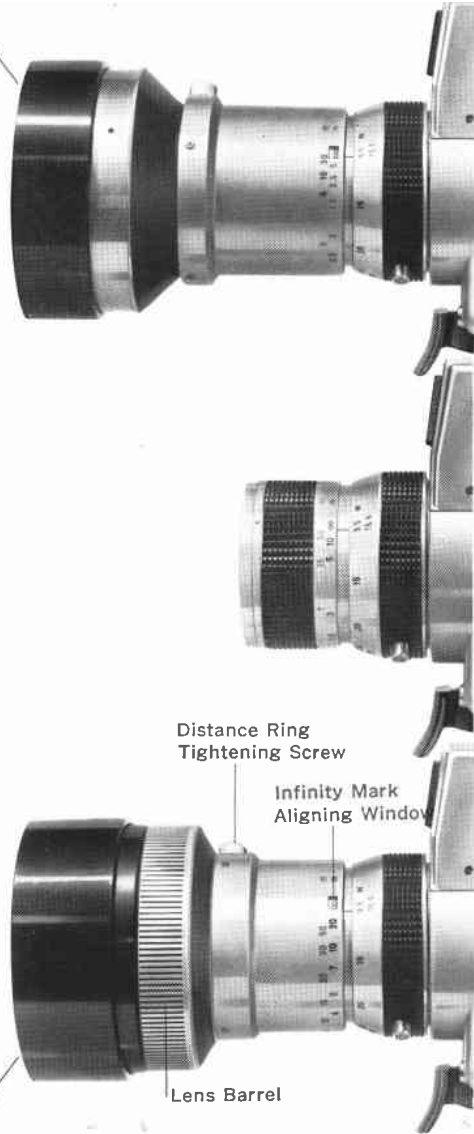
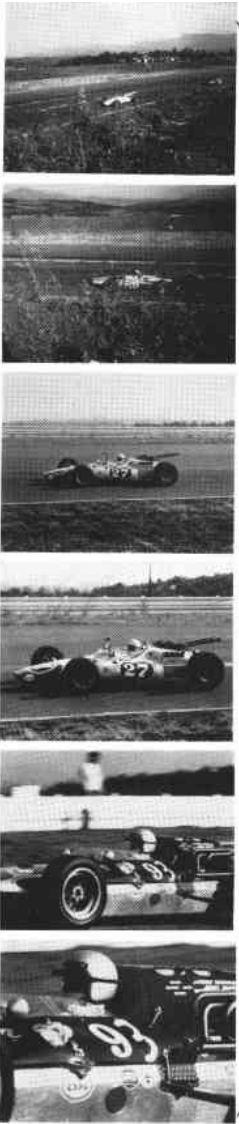

Converters

Canon C-8 Wide-Converter 0.65x and Tele-Converter 1.6x are available as the attachments for the taking lens of Canon Auto Zoom 518 SV. The converted focal length range becomes 6.2-31mm and 15.6-78mm respectively, with a zooming ratio of 1:5, making possible shooting in a wide range from standard to super-wide or to super-telephoto.

Method of Attaching

- 1 Remove the dust cap of the Converter and attach the Converter over the taking lens of the camera.
- 2 Turn the lens barrel of the Converter and screw the Converter into the front mount of the zoom lens.
- 3 Loosen the distance ring tightening screw on the Converter.
- 4 Turn the distance ring of the Converter so that the infinity mark (∞) appears in the infinity mark aligning window. Fix the distance ring securely with the tightening screw.
- 5 Pull out the built-in hood.

■ The distance ring part of the Converter is coupled to its lens part by the distance ring tightening screw. Be sure to fix it tight to prevent the lens from dropping.

■ Focusing and zooming are performed in the ordinary manner. See page 10.

Technical Data

	Wide-Converter 0.65x	Tele-Converter 1.6x
Lens :	4-component, 5-element afocal system. Spectra hard coating.	4-component, 5-element afocal system. Spectra hard coating.
Filter Size :	72mm.	72mm.
Cap Size :	80mm.	80mm.
Lens Hood :	Built-in type.	Built-in type.
Size :	87mm x 80mm ϕ (3-3/8" x 3-1/8" ϕ).	80mm x 80mm ϕ (3-1/8" x 3-1/8" ϕ).
Weight :	430 grams (15-1/4 oz.).	420 grams (14-7/8 oz.).



Shooting with Artificial Light

Your camera has a built-in CCA (Color Conversion A) filter so that you can use tungsten type color film, for example, Kodachrome II "Outdoor and Indoor Type A", under daylight conditions or with blue bulb.

- 1** When using Kodak Instamatic Movie Light or Bell & Howell Movie Lite #43461, the built-in CCA filter will be automatically cancelled by installing its bracket to the slit on top of the camera.
- 2** When using normal light bar or floodlight, insert the filter cancellation key, supplied with your camera, all the way into the slit on top of the camera.
 - When using black and white or daylight type color films, the built-in CCA filter is automatically cancelled with the insertion of the film cartridge. When shooting under artificial lighting with daylight type color film, use a blue bulb or a CCB filter over the lens.

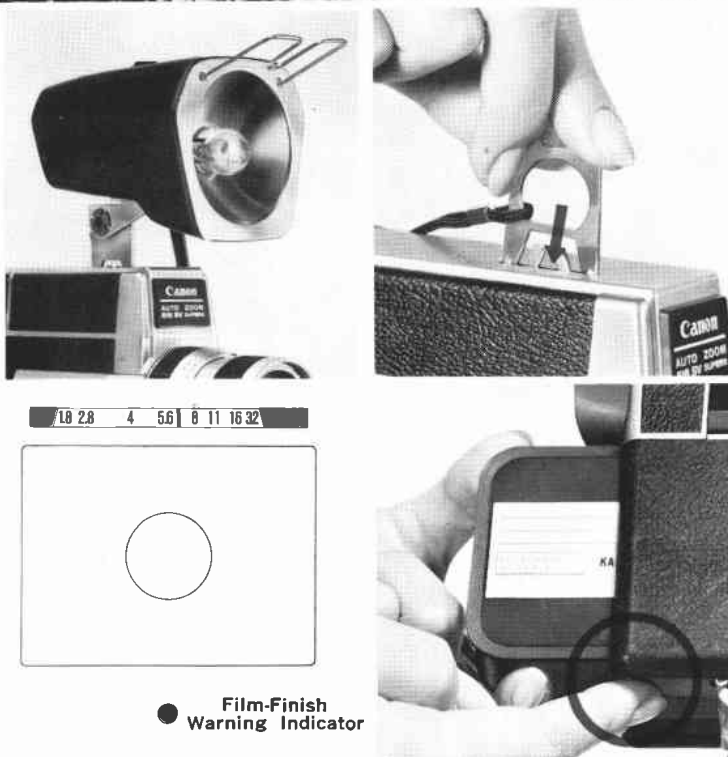

● Film-Finish Warning Indicator

Unloading of Film Cartridge

- 1** When the footage counter reaches at the point of 47.5 ft., the film-finish warning indicator in the viewfinder will light up in yellow.
- 2** Stop shooting when the footage counter reaches "50". Continue feeding the film until it has reached the end and take out the film cartridge by pulling the cartridge guide.
- 3** Send the film cartridge to an authorized processor. It will be returned to you wound on a reel so that immediate projection is possible.



Proper Care of the Camera

- 1** It is important that the aperture section, through which the film passes, always be kept clean by blowing the dust away with a blower. Do not use anything hard, such as a metal brush.
- 2** Before putting the camera into its case, turn the shutter lock dial to "OFF".
- 3** Keep the camera away from dust and moisture. Use a soft brush to get rid of dust and a soft dry cloth for wiping. Do not keep naphthalene or camphor near the camera.
- 4** Do not leave the camera inside closed automobiles during the daytime or in direct sunlight.
- 5** Use a blower to remove dust on the lens or brush lightly with a brush. If you should inadvertently get a fingerprint on the lens, wipe the lens lightly with a silicone cloth.
- 6** When the camera is not to be used for a prolonged period of time, remove the batteries and keep them in a dry place.

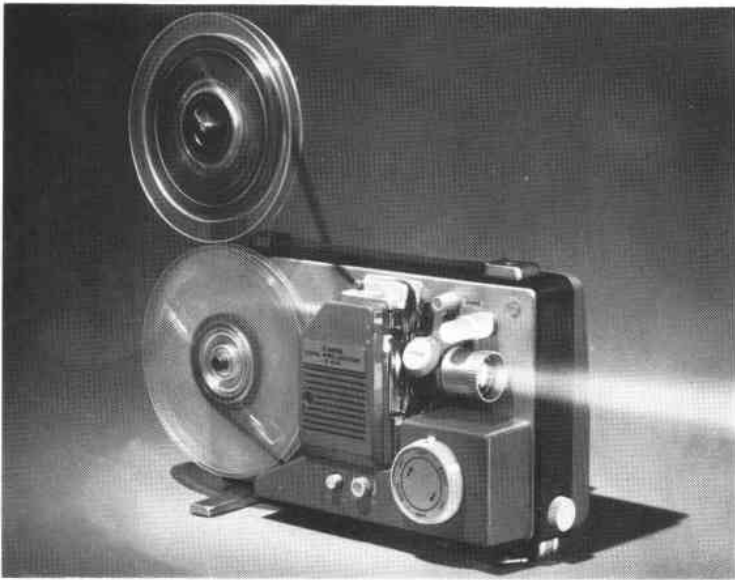

Canon Cine Projector S-400

Canon Cine Projector S-400 is the newest and highest quality movie projector. It can automatically load and rewind all 8mm film—Super 8, Single 8 and regular 8mm film up to 400 feet. Operation is very simple. Just insert the film end into the projector, turn the switch, and the film will run completely through and rewind with no need for resetting or touching any other switches. The Cine Projector S-400 has a fast 17-28mm F 1.3 zoom lens, 8v 50w mirror lamp, adjustable projecting speeds including slow motion. This projector can be used in any country as it has a choice of seven different voltages from 100 to 240 v.

Size : 333 x 169 x 155mm (1'1-1/8" x 6-5/8" x 6-1/8").
Weight : 5.2 kg (11 lb. 7-3/8 oz.).

Technical Data

Type: 8mm movie camera using Super 8 film cartridge.

Frame Size: 4 x 5.4mm.

Lens: F1.8 lens with zooming range of 9.5-47.5mm. 11-component, 14-element construction. Zoom ratio, 1:5. Spectra hard coating. Filter size, 48mm. Cap size, 50mm. Zoom range can be extended to super-wide-angle (6.2-31mm) with optional Wide-Converter 0.65x, and to super-telephoto (15.6-78mm) with Tele-Converter 1.6x.

Viewfinder: Single-lens reflex type. Contains exposure indicator, f/stop scale, over/under exposure warning marks, microprism screen rangefinder, and film-finish warning indicator. Eyepiece is adjustable (-3 to +1 diopter).

EE Mechanism: Through-the-lens metering using CdS photocell with servo EE meter. Automatic aperture setting coupled to film speed and filming speed.

Light Measuring Range: Between ASA 400 f/1.8 at 18 fps and ASA 16 f/32 at "SLOW MOTION".

Film Speed: Automatically set by inserting film cartridge. Tungsten-type film, ASA 25-400. Daylight-type film, ASA 16-250.

CCA Filter: Built-in. Corrects color of tungsten-type film when used in daylight. Automatically cancelled on insertion of daylight-type film cartridge, installation of exclusive movie light bar or manually on the filter cancellation key.

Filming Speed: 18 fps, 24 fps, "SLOW MOTION" (approx. 36 fps), and single frame.

Shutter Lock Dial: For safety lock, running and running lock/remote control positions.

Manual Aperture Control: Possible by releasing the EE mecha-

nism. Fadings possible with the aperture control ring.

Power System: Film drive and power zooming operated by two micromotors. Entire zooming is done in approximately six seconds.

Power Source: Four 1.5 v penlight (size AA) batteries in trigger grip. For film drive, power zooming and metering. Sufficient power for 10 cartridges of film under normal conditions. Battery checker built in.

Manual Zooming: Performed by manual zooming lever. Revolving angle, 100°.

Footage Counter: Automatically resets when the cartridge is taken out.

Film Transport Indicator: For checking film advancement.

Release Sockets: For single frame, remote control and cable release.

Trigger Grip: Fixed type, housing batteries.

Accessories: Carrying Case, C-8 Wide-Converter 0.65x, C-8 Tele-Converter 1.6x, Remote Switch 3, Lens Hood S-50, 48mm Filter (screw-in type), 48mm Close-Up Lenses 240 C-8 and 450 C-8, Finder Cover 4, 50mm Lens Cap, Release 5, Filter Cancellation Key.

Size: 212 x 193.5 x 60.5mm (8 $\frac{3}{8}$ " x 7 $\frac{5}{8}$ " x 2 $\frac{3}{8}$ ").

Weight: 1,200 grams (2.65 lbs.).

Subject to alterations.



CANON INC.

9-9, Ginza 5-chome, Chuo-ku, Tokyo 104, Japan

CANON U.S.A., INC.

64-10 Queens Blvd., Woodside, New York 11377, U.S.A.

CANON OPTICS & BUSINESS MACHINES CO., INC.

3113 Wilshire Blvd., Los Angeles, California 90005, U.S.A.

CANON AMSTERDAM N.V.

Gebouw 70, Schiphol Oost, Holland

CANON LATIN AMERICA, INC.

Apartado 7022, Panama 5, Panama

PUB. K2091-5362A

1070N2

PRINTED IN JAPAN