

BUGNE A PANNELLO LMS30-40



BUGNE SINGOLE SMS30-30 + 30-40

**Cornici  
Marcapiani  
Cornicioni  
Davanzali  
Sopraporte  
Coprigronde  
Fasce cappotto  
Bugne  
Mensole**



**Produzione  
CORNICI PER FACCIATE  
in polistirene  
trattato con  
Resina e Quarzo**

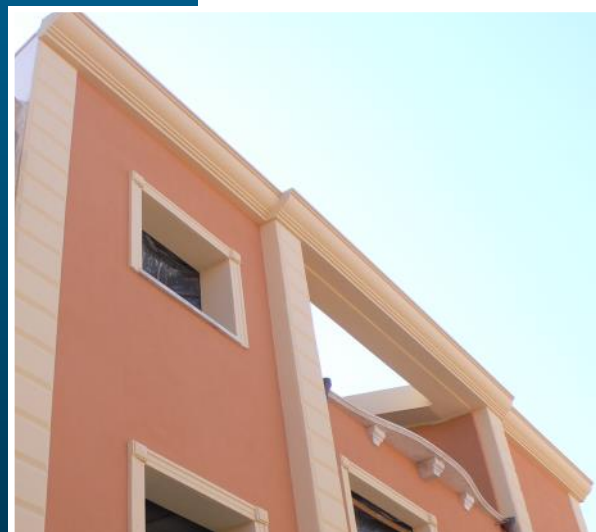

**Eleganza  
& Praticità**

www.dekoritaly.eu

**BUGNE E SPIGOLI**

**Bugne a pannello**

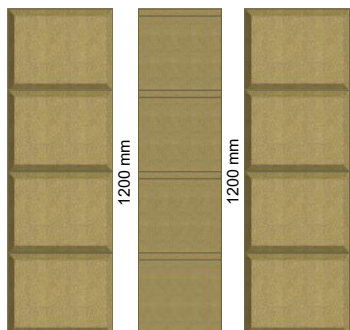

Art. LMS Art. LAL Art. SCL

**Dimensioni**

Pannello con 5 Bugne lineari dim. 20x20 cm.  
Pannello con 5 Bugne lineari dim. 20x30 cm.  
Pannello con 4 Bugne lineari dim. 30x30 cm.  
Pannello con 4 Bugne lineari dim. 30x40 cm.  
Pannello con 4 Bugne lineari dim. 30x50 cm.

**Bugne singole**



Art. SMS

Art. SAL

Art. SCL

**Dimensioni**

Bugna 20x30 cm. Bugna 20x20 cm.  
Bugna 30x30 cm. Bugna 25x25 cm.  
Bugna 30x40 cm. Bugna 25x40 cm.  
Bugna 30x50 cm. Bugna 25x50 cm.  
Bugna 30x60 cm. Bugna 25x60 cm.

Rivenditore



## Cornici per porte e finestre

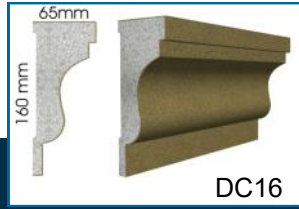
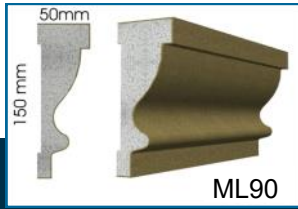
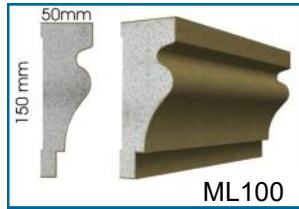
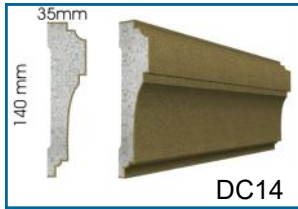
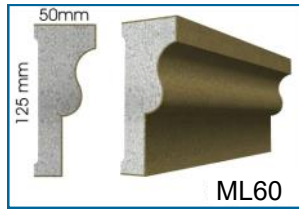
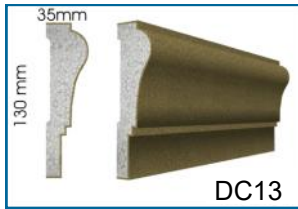
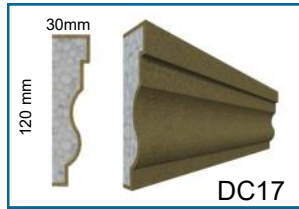
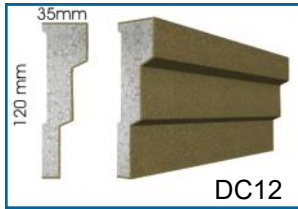
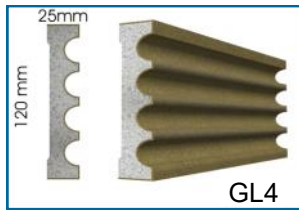
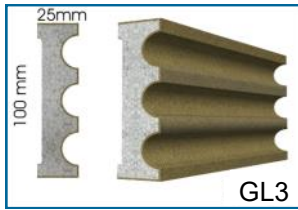
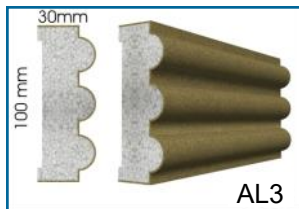
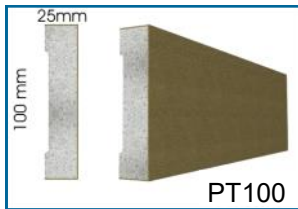
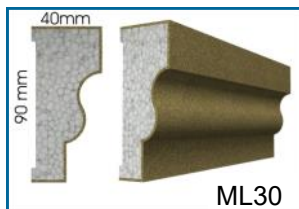
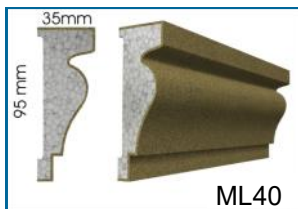

## Cornici e sottogronde

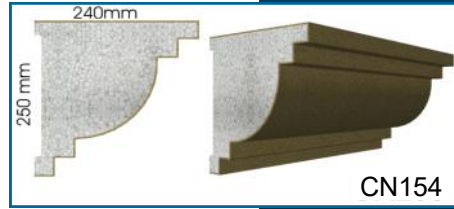
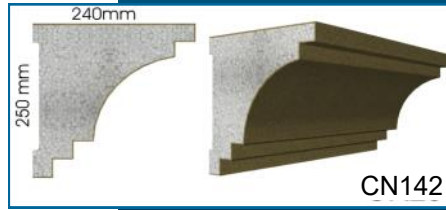
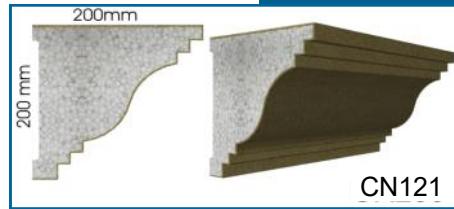

## Marcapiani

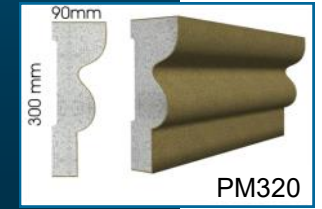
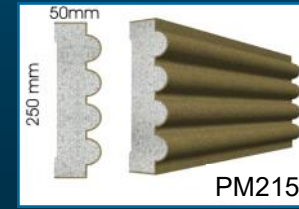
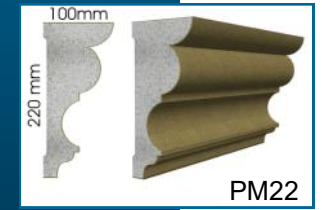
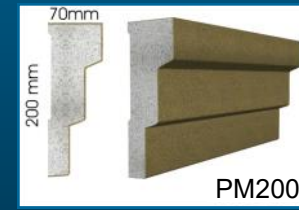
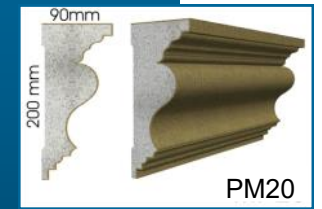
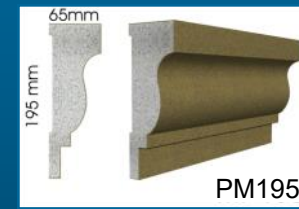
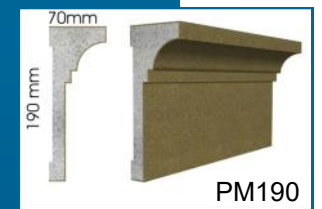
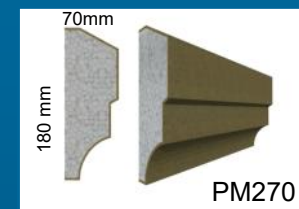

Le cornici resistenti pratiche e leggere!

### Cornicione copri gronda

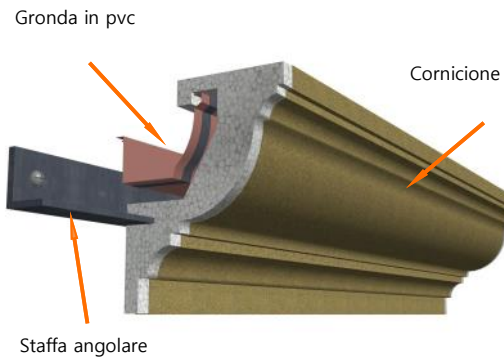

Fase di montaggio dei cornicioni copri gronda

Produzione su richiesta di cornici ed elementi curvi

Linea CORNICI PER FACCIATE

www.dekoritaly.eu